

**32 Pole
With Ground**
PROTECTION
IP65
RATING
E307105
CE

**Component
Parts**

Pre-Assembled Units

Covers

FEMALE

29022
(1-16)

Insert



29026
(17-32)

Bulkhead Housing

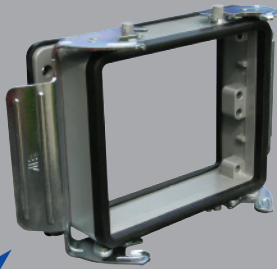

29046



403050

Hood

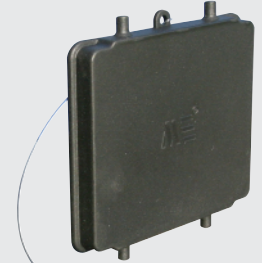

29660

Standard Part Numbers are
NPT threads.
Part numbers with an "M"
are metric thread.

Top Entry
29062
29062M

Side Entry
29063
29063M

Top Entry
403056
403056M

Side Entry
403057
403057M

MALE

29023
(1-16)

Insert

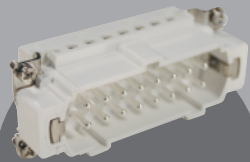

29027
(17-32)

Hood

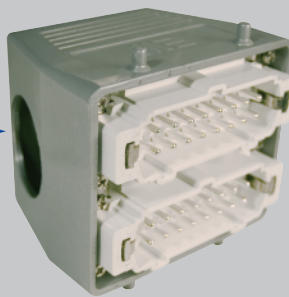
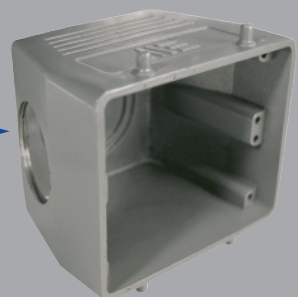

29662

Top Entry
29060
29060M

Side Entry
29061
29061M

Top Entry
403054
403054M

Side Entry
403055
403055M



Connectors should not be coupled
and decoupled under electrical load.

Inserts

Number of contacts	32 Pole w/ ground
Electrical data to DIN EN61 984	16A 400V 6KV 3
Current	16A
Voltage	400V
Rated Impulse Voltage	6KV
Insulation Resistance	≥10 ¹⁰ Ω
Temperature Range	-40 to 125°C
Flammability	UL94-V0

Contacts

Screw terminal	
Material	Copper alloy
Surface plated	hard-silver
Contact resistance	≤ 1m Ω
Wire size	2.5mm ² / 14 AWG
Torque	0.5Nm
Stripping Length	7.5mm

Metal Hoods & Housings

Material	Aluminum
Surface	Powder coated
Seals	NBR
Degree of Protection Acc To	
DIN EN60529 for coupled connectors	IP65
Thread Size	NPT 3/4" or M40

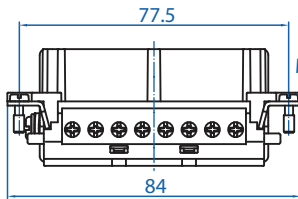
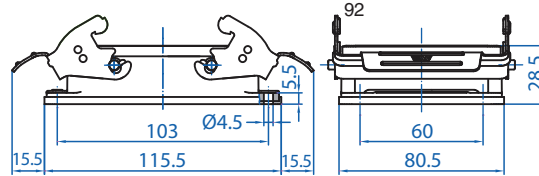

29022
29026

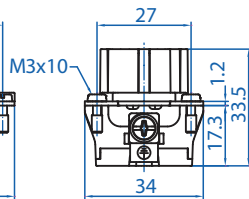

29046

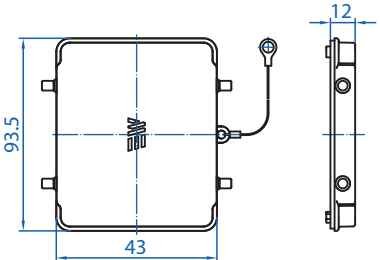

29660

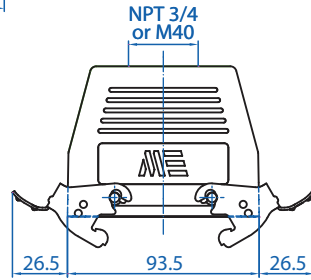

29062

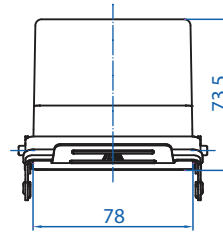

29061

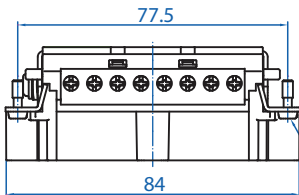

29023
29027

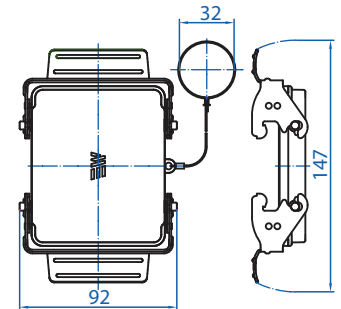
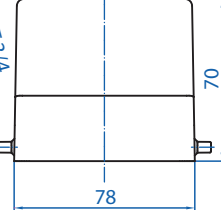
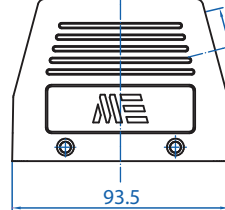
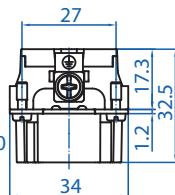

29662



Connectors should not be coupled and decoupled under electrical load.

All dimensions are shown in millimeters. To convert to inches divide by 25.4.

Mouser Electronics

Authorized Distributor

Click to View Pricing, Inventory, Delivery & Lifecycle Information:

Altech:

[29026](#) [29027](#) [29046](#) [29060](#) [29061](#) [29062](#) [29063](#) [29660](#) [29662](#) [403050](#) [403054](#) [403055](#) [403056](#) [403057](#)
[29060M](#) [29061M](#) [29062M](#) [29063M](#) [403054M](#) [403055M](#) [403056M](#) [403057M](#)