



深圳市钜硕电子有限公司  
SHENZHEN JUSHUO ELECTRONICS CO., LTD

# 承认书

SPECIFICATIONS FOR APPROVAL

客 户:

CUSTOMER:

品 名:

DESCRIPTION:

WAFER插针 2.0mm间距直针插件

料 号:

PART NO:

JS20T-S\*\*PHA-00

## 承 认 印 ACKNOWLEDGMENT SEAL

客 户 确 认 CUSTOMER APPROVAL		本 司 确 认 TRX APPROVAL		
核 准 APPROVAL		核 准 APPROVAL	贺 文 超	
工 程 PROJECT		工 程 PROJECT	吴 佩 隽	
品 保 Q A		品 保 Q A	王 成 铎	

◎ 联 系 人: 幸坤新

CONTACT PERSON

◎ 公 司 电 话: 0755-27220896

COMPANY TELEGRAMS

◎ 公 司 地 址: 广东省深圳市松岗镇下山门钜硕工业园

COMPANY ADDRESS

◎ 公 司 官 网: <http://www.jushuo.net.cn>

COMPANY WEBSITE

◎ 手 机: 13723739518

MOBILE PHONE

◎ 邮 箱: [jushuo518@163.com](mailto:jushuo518@163.com)

E-MAIL

REV.	DESCRIPTION	DATE
A/0	新版发行	2024/05/18

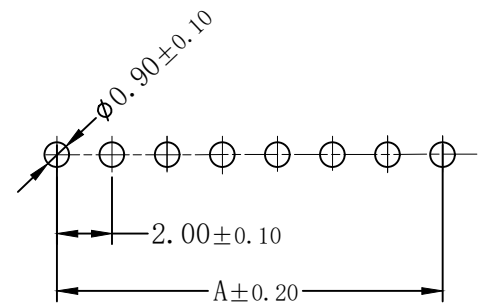
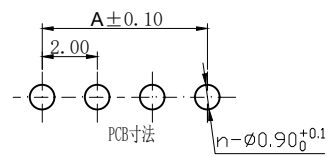
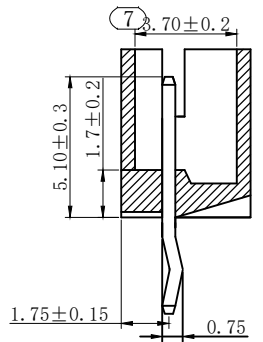
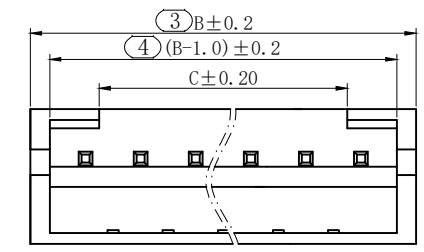
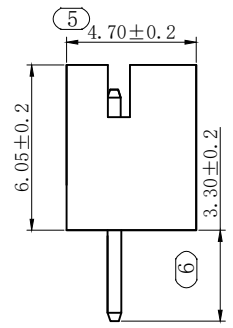
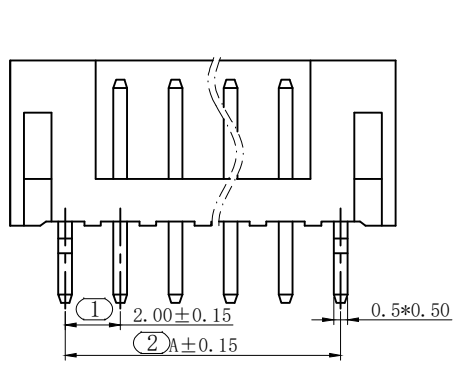

SUGGESTED PCB LAYOUT  
(COMPONENT SIDE)

技术要求:

- 1、塑件材料: PA66 (UL-94V-0)
- 2、接触件: 黄铜镀锡
- 3、接触电阻: ≤10mΩ
- 4、绝缘电阻: ≥1000MΩ
- 5、额定电压: 250V AC DC
- 6、额定电流: 2.0A AC DC
- 7、耐压: 能承受1000V AC/Minute
- 8、工作温度: -45° ~ +85°
- 9、可焊性试验: 浸锡面积≥95%温度235<sup>+5</sup><sub>0</sub>, 时间 2.5±0.5秒
- 10、铅和镉等六大有害物质含量要符合环保要求

产品实拍图:

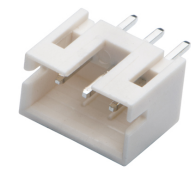

Circuits	Dimensions (mm)	
	A	B
02	2.00	6.00
03	4.00	8.00
04	6.00	10.00
05	8.00	12.00
06	10.00	14.00
07	12.00	16.00
08	14.00	18.00
09	16.00	20.00
10	18.00	22.00
11	20.00	24.00
12	22.00	26.00
13	24.00	28.00
...	...	...
20	38.00	44.00



工程专用章

20	端子 Contact	黄铜	n×1	数量: 零件表面镀层30u"MIN, 屏镀层 80u"MIN.
1	基座 Wafer	PA66(UL94V-0)	1	白色
序号	名称	材料	数量	备注

GENERAL TOLERANCES		DRAWN BY		<b>深圳市钜硕电子有限公司</b> SHENZHEN JUSHUO ELECTRONIC CO., LTD	
0.X	±0.25 X.* ±3°	CHK. BY			
0.XX	±0.12	APRV. BY			
0.XXX	±0.05 X.X* ±0.5°	DRAWING NO.		SHEET	PART NO.
UNIT	SIZE	SCALE		1 OF 1	JS20T-S**PHA-00 PH 2.0mm 直针插件
MM	A4	1:1		JS-20240518322 TITLE	

# 产 品 规 格 书

## PRODUCT SPECIFICATION

### 【1】适用范围 SCOPE

本规格书适用于：2.0mm间距WAFER插针连接器

This specification covers the 2.0mm Pitch wafer patch socket

Connectors

### 【2】产品名称及型号 PRODUCT NAME AND PART NUMBER

产品名称 Product Name	产品型号 Part Number
WAFER插针	JS20T-S**PHA-00

### 【3】定格 RATINGS

项目 Item	规 格	Requirement
最大容许电压 Rated Voltage(MAX)	250V	[AC/DC(有效值 Virtual value)50Hz]
最大容许电流 Rated Current(MAX)	2A	
使用温度范围 Ambient temperature Range	-45℃ ~ +85℃	

\*: (包含通电后的温度上升) including terminal temperature rise

**【4】 部件规格 COMPONENT SPECIFICATION**

部件名称 Part name		型号 model	材质 The material
4.1	基座 Base	JS20T-S**PHA-00	LCP E130i
4.2	插针 Pin	JS20T-S**PHA-00	磷铜 Phosphor copper
4.3	固定片 stator	JS20T-S**PHA-00	磷铜 Phosphor copper

**【5】 应用 USE**

项目 Item		条件 Test Condition
5.1	环保 Environmental Protection	产品符合ROHS环保要求。 Products in line with ROHS environmental protection requirements.
5.2	包装 Packing	产品内包装为连带，外包装为纸箱，产品在箱内密封，不晃动。 The inner packing of the product is joint and several, the outer packing is carton, the product is sealed in the box, do not shake.
5.3	运输 Transport	允许用任何方式运输，但需避免雨雪淋和阳光照射，不能有碰撞和挤压等机械损伤，运输环境温度为-45℃+85℃。 It is allowed to be transported by any means, but it should avoid rain, snow and sunlight, no mechanical damage such as collision and extrusion, and the ambient temperature of transportation is -45℃+85℃.
5.4	贮存 Storage	在环境温度为- 45℃~+ 85℃，相对湿度不大于90%，周围空气中没有酸性，碱性及其它腐蚀性气体的仓库中贮存。贮存期为12个月，超过12个月需重新检查。 The connector should be in the ambient temperature of -45℃~+85℃, the relative humidity should not be more than 90%, there is no acid, alkaline and other decay in the surrounding air Storage of corrosive gases in a warehouse. The storage period is 12 months, exceeding 12 months.

## 【6】性能 PERFORMANCE

### 6.1 电气性能 Electrical Performance

项目 Item		条件 Test Condition	规格 Requirement
6.1.1	接触电阻 Contact Resistance	将连接器插入，用接触电阻仪进行测试，测量连接器两个端子之间组成一个闭合的回路。 Plug in the connector and test it with a contact resistance meter to measure both terminals of the connector Form a closed loop between.	$\leq 20 \text{ m}\Omega \text{ MAX}$
6.1.2	绝缘电阻 Insulation Resistance	将连接器插入，在相邻接触件之间和接触件与外壳之间施加1000V DC电压，持续1分钟进行测试。 Plug in the connector and apply 1000V DC voltage between the adjacent contacts and between the contacts and the enclosure for 1	$1000\text{M}\Omega \text{ MIN}$
6.1.3	耐电压	适合 FPC/FFC 嵌合；相邻端子间或端子与地面间加 AC 200V（有效值）历时 1 分钟下测定。 Mate applicable FPC/FFC and apply 200V AC（virtual value）for 1minute between adjacent terminal or ground.	无击穿现象 No Breakdown

### 6.2 机械性能 Mechanical Performance

项目 Item		条件 Test Condition	规格 Requirement
6.2.1	PIN针固定力 Pin fixing force	将针座固定在插拔力机上，在针脚前端施加力，以每分钟 $25 \pm 3\text{mm}$ 的速度；直到针退出针座的拔出力。 Fix the pin holder on the drawing machine and apply force on the front end of the pin at a rate of $25 \pm 3\text{mm}$ per minute until the pin is withdrawn from the pin holder.	单个PIN针：5N MIN Single pin 5N MIN
6.2.2	端子在塑胶件中保持力 Terminal Retention in Plastic parts	端子与孔座配合，以每分钟 $25 \pm 3\text{mm}$ 的速率沿导线方向，将端子从孔座中拔出的力。 The terminal shall be matched with the hole seat, and at the rate of $25 \pm 3\text{mm}$ per minute along the conductor direction, theThe force that the terminal is pulled out of the socket.	单个端子：5N MIN Single terminal: 5N MIN

### 6.3 环境性能 Environmental Performance

项目 Item		条件 Test Condition	规格 Requirement	
6.3.1	耐热性 Heat Resistance	将连接器放在温度为+85℃±2℃的环境中96H, 取出放在正常环境1-2H后再进行测试。 85±2℃, 96 hour	外观 Appearance	无损坏 No Damage
			接触抵抗 Contact Resistance	30 m Ω MAX
6.3.2	耐寒性 Cold Resistance	将连接器放在温度为-45℃±2℃的环境中96H, 取出放在正常环境中1-2H后再进行测试。 -45±2℃, 96 hour	外观 Appearance	无损坏 No Damage
			接触抵抗 Contact Resistance	30 m Ω MAX
6.3.3	耐湿性 Humidity	将连接器放在温度为45℃±2℃, 相对湿度90~96%的环境中, 持续96H, 经试验后, 取出放在正常环境中1~2H后再进行测试。 Temperature: 45±2℃ Relative Humidity: 90-96% Duration: 96 Hours	外观 Appearance	无损坏 No Damage
			接触抵抗 Contact Resistance	50 m Ω MAX
			耐电压 Dielectric Strength	500V AC/MIN
6.3.4	温度循环 Temperature Cycling	试验样品分别放入高低温试验箱, 按下列步骤调试温度: a) 在-45℃±3℃的恒温条件下放置30分钟; b) 在常温条件下放置1H; c) 在85℃±3℃的恒温条件下放置30分钟; d) 在常温条件下放置1H; 从a到d为一个循环周期, 共进行5个循环, 在正常环境中恢复2H后进行检查。 a) -45±3℃ 30minutes; b) 常温常湿1H; c) 85±3℃ 30minutes; d) 常温常湿1H, 循环 5 次。 5 cycles of	外观 Appearance	无损坏 No Damage
			绝缘抵抗 Insulation Resistance	30 M Ω MIN
6.3.5	耐盐雾性 Salt Spray	试验样品从试验箱顶悬挂; 45±2℃、5±1%的盐水喷雾 48 小时; 试验后常温水洗; 再室温干燥。 48 hours exposure to a salt spray from the 5±1% solution at 45±2℃	外观 Appearance	无损坏 No Damage
			接触抵抗 Contact Resistance	60 m Ω MAX

项目 Item		条 件 Test Condition	规格 Requirement	
6.3.6	耐盐雾性 Salt Spray	试验样品从试验箱顶悬挂； $45\pm 2^{\circ}\text{C}$ 、 $5\pm 1\%$ 的盐水喷雾 48 小时；试验后常温水洗；再室温干燥。 $48\pm 4$ hours exposure to a salt spray from the $5\pm 1\%$ solution at $45\pm 2^{\circ}\text{C}$ .	外观 Appearance	无损坏、腐蚀 No Damage
			接触抵抗 Contact Resistance	$30\text{ m}\Omega$ MAX
6.3.7	可焊性 Solder Ability	将样品焊接面处浸入 $245\pm 5^{\circ}\text{C}$ 的锡槽中；历时 $2.5\pm 0.5\text{ sec}$ 。 Soldering Time: $2.5\pm 0.5\text{ sec}$ . Soldering Temperature: $245\pm 5^{\circ}\text{C}$ $0.2\text{ mm}$ from terminal tip.	外观 Appearance	无损坏 No Damage
			沾锡面积 Tin Area	95%以上 Above 95%
6.3.8	耐焊性 Soldering Resistance	将连接器置于PCB板上，浸入 $260\pm 5^{\circ}\text{C}$ 的锡槽中；历时 $5\pm 0.5\text{ sec}$ 。 Soldering Time: $5\pm 0.5\text{ sec}$ . Soldering Temperature: $260\pm 5^{\circ}\text{C}$ $0.2\text{ mm}$ from terminal tip.	外观 Appearance	无损坏、变形 No Damage
			沾锡面积 Tin Area	95%以上 Above 95%

( ) : 参考规格 Reference Standard

{ } : 参考单位 Reference Unit

## 【7】 外观及尺寸 APPEARANCE AND SIZE

项目 Item		条 件 Test Condition
7.1	外观 Appearance	塑胶件表面应无明显疤痕、杂色、开裂、毛刺、飞边、缺料及影响使用的变形；金属件表面应光洁、无锈蚀、氧化、脱皮、发黑及明显的机械损伤等缺陷。 The surface of plastic parts shall be free of obvious scars, mottled, cracked, burr, flash, lack of material and deformation affecting the use; the surface of metal parts shall be smooth and clean No rust, oxidation, peeling, blackening and obvious mechanical damage.
7.2	尺寸 Size	参照工程图 Reference engineering drawing

### QC工程图

产品描述: FPC&WAFER连接器系列	产品料号: 适用于所有 FPC&WAFER连接器系列	版本: A	编号及版本: JS-SIP-0075-01	制定日期: 2024/05/18
----------------------	----------------------------	-------	-----------------------	------------------

作业流程	作业过程描述	控制要点/参数/条件	检验频率	作业者/检验者	管制界限值	检测方法	级判定	处理方式
	开始							
	进料检验	原材料、零部件料号、规格	MIL-STD-105E	IQC	依工程图/SOP/SIP	目视/送实验室检测	2&3	允收/退货/挑选/特采
	投入物料	原材料、零部件料号、规格	每批物料	线长/IPQC	生产任务单/BOM	目视/送实验室检测	1	退货
	冲压/成型生产	尺寸/外观/功能/装配等	抽检/自检 2模/1H	作业员/IPQC	依工程图/SOP/SIP	目视/测试/测量/装配	1	标示隔离/重工/报废
	外观	外观/尺寸/功能	全检 两模/1H	作业员/IPQC	依工程图/SOP/SIP	目视/测量	1	标示隔离/重工
	包装入库	标示日期/班次/小心运输	袋 /每批	作业员/IPQC	入库单	目视	1	调整
	投入物料	零部件料号/规格	每批物料	线长/IPQC	生产任务单/BOM	目视/送实验室检测	1	退货/挑选/特采
	裁切端子	端子无变形/氧化等	自检	作业员	作业指导书	目视	0	调整
	自动机插端/手工插端	端子无变形/铆合尺寸/折料带端子无变形	2模/1H	作业员/IPQC	依工程图/SOP/SIP	目视/测量	1	调机
	装配塑胶	装配到位/无缺料/毛边/堵孔/断裂/混料/错位/保持力	2模/1H	作业员/IPQC	依工程图/SOP/SIP	目视/送实验室检测	1	标示隔离/重工/报废
	装配焊片	装配到位/毛边/堵孔/断裂/混料/脱落	2模/1H	作业员/IPQC	依工程图/SOP/SIP	目视/送实验室检测	1	标示隔离/重工/报废

核准: 幸坤新

审核: 刘朋飞

制订: 陈艳

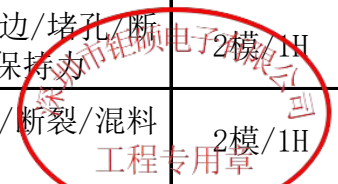



### QC工程图

产品描述: FPC&WAFER连接器系列	产品料号: 适用于所有 FPC&WAFER连接器系列	版本: A	编号及版本: JS-SIP-0075-02	制定日期: 2024/05/18
----------------------	----------------------------	-------	-----------------------	------------------

作业流程	作业过程描述	控制要点/参数/条件	检验频率	作业者/检验者	管制界限值	检测方法	判定级别	处理方式
	初检	无缺料/毛边/堵孔/色差/高低针/混料/斜针/缺针/电镀不良等	全检	FQC	作业指导书	目视/测量	0	标示隔离/重工
	入管	无混料/少数/多装等	自检	作业员	作业指导书	目视	0	重工
	总检	无缺料/毛边/堵孔/色差/高低针/混料/斜针/缺针/电镀不良等	全检	FQC	作业指导书	目视/测量	0	标示隔离/重工
	0QC抽检	无缺料/毛边/堵孔/色差/高低针/混料/斜针/缺针/电镀不良等	抽检	OQC	SIP/SOP/MIL-STD-105E II	目视/测量	0	标示隔离/重工
	包装入库	分清每批日期/搬运/轻放	每批	作业员	入库单	目视	0	调整
	出货检验	合格标签内容/出货内容	每批	OQC	作业指导书	目视	1	标示隔离/重工
	完成							



备注: 1. 每次开始生产调机及换料后必须进行首件检验, 数量为两模。工程图面标示“▼”的尺寸全量测; 耐温测试、焊锡性测试、功能测试等。  
 2. 插入力、拔出力及保持力请参见工程图及规格书

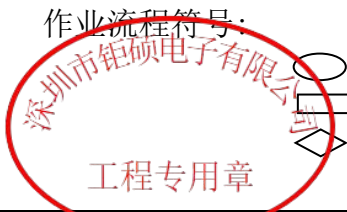

判定级别:

- 0. 作业员自检
- 1. 线长/IPQC/IPQC线长
- 2. 工程师/课长/经理
- 3. 副总/总经理

作业流程符号:



-  开始/终止
-  作业
-  检验/测试

-  物料投入
-  存储

核准: 幸坤新

审核: 刘朋飞

制订: 陈艳