

**MODEL:** CMS-160903-18SP-X8 | **DESCRIPTION:** SPEAKER

**FEATURES**

- IPX8 rated
- rated 1 W
- 8  $\Omega$



**SPECIFICATIONS**

parameter	conditions/description	min	typ	max	units
input power	max power: as per IEC-268-5, in 1 cc box		1.0	1.2	W
impedance	at 2.0 kHz, 2.83 Vrms in 1 cc box	6.8	8	9.2	$\Omega$
coil resistance		6.48	7.2	7.92	$\Omega$
resonant frequency [Fo]	at 2.83 Vrms, 10 cm in 1 cc box	760	950	1,140	Hz
frequency response		Fo		20,000	Hz
sound pressure level	at 2.83 Vrms, 10 cm, avg 1.0, 1.18, 1.5 kHz, 1 cc box	92	95	98	dB
distortion	at 2.0 kHz, 2.83 Vrms, 10 cm			10	%
buzz, rattle, etc.	must be normal at sine wave, 0.2~ 2kHz in 1 cc box			2.83	V
polarity	cone moves forward w/ positive dc current to "+" terminal				
dimensions	16 x 9 x 3.0				mm
magnet	Nd-Fe-B				
frame material	PPA				
cone material	PEEK				
terminal	solder pads				
weight			1.5		g
operating temperature		-20		70	$^{\circ}$ C
storage temperature		-40		85	$^{\circ}$ C
hand soldering	for maximum 3 seconds			380	$^{\circ}$ C
RoHS	yes				
IP level	IPX8 (front side)				

Notes: 1. All specifications measured at 15-35 $^{\circ}$ C, humidity at 25-75%, under 86-106 kPa pressure, unless otherwise noted.

## MECHANICAL DRAWING

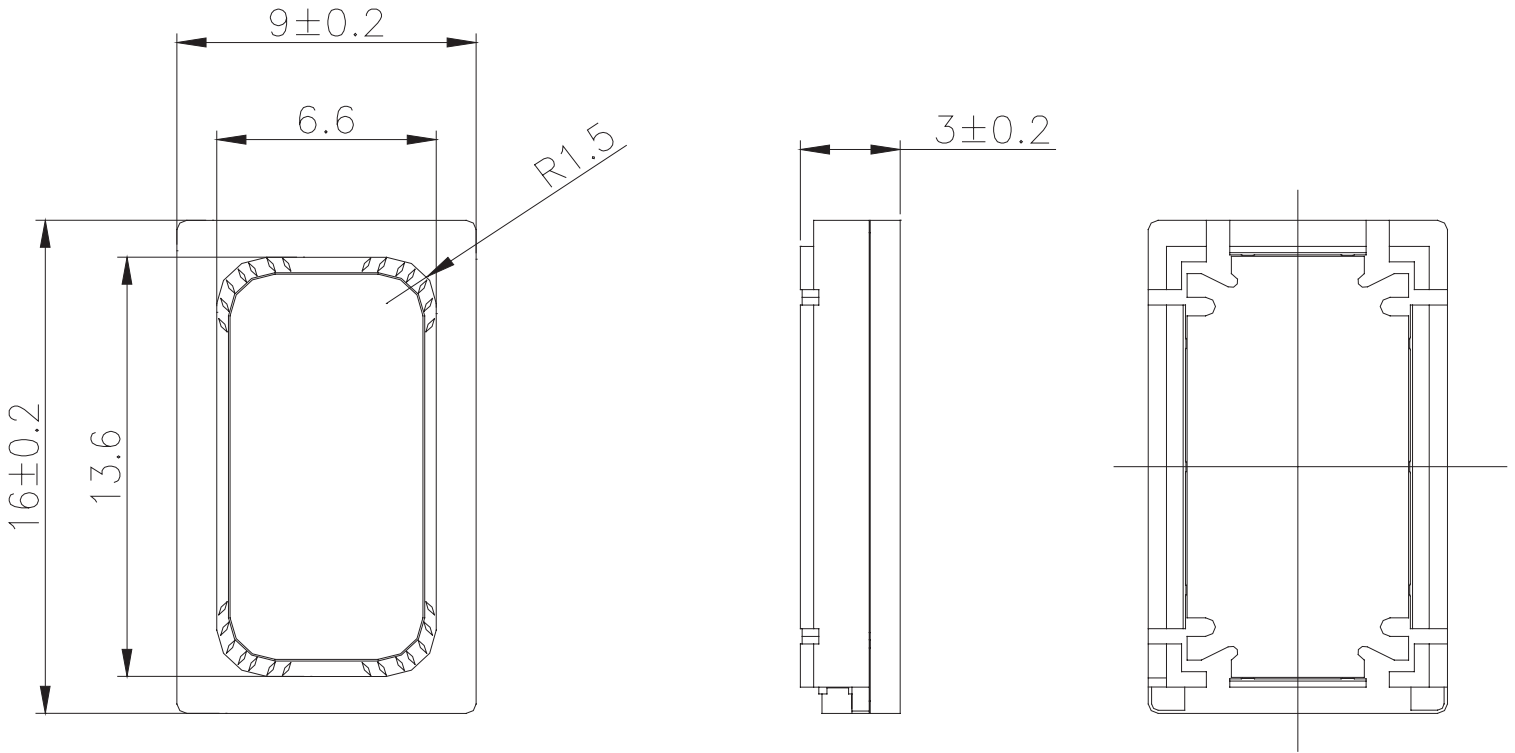
units: mm  
tolerance:  $\pm 0.2$  mm



## RESPONSE CURVES

### Frequency Response Curve

Test Conditions: 2.83 Vrms / 10 cm in 1 cc box

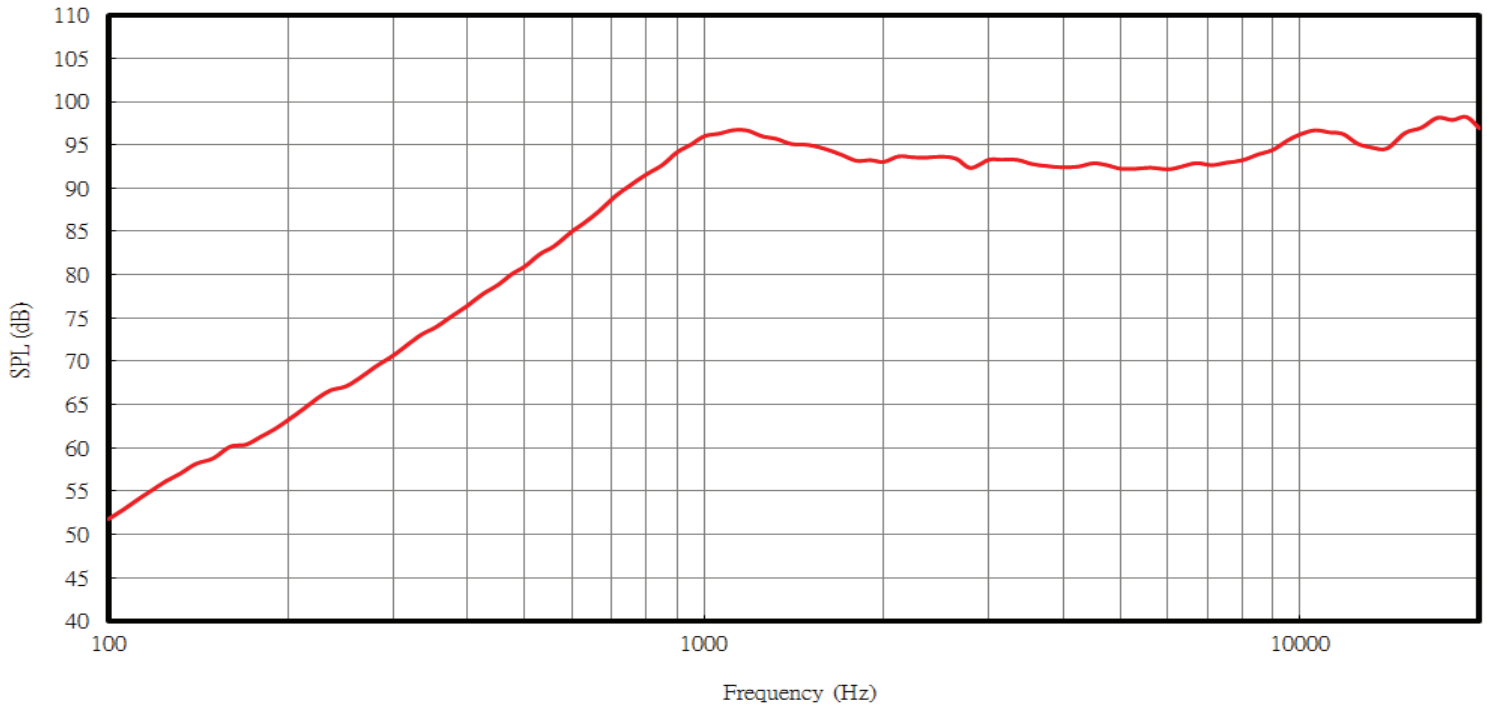

### Total Harmonic Distortion Curve

Test Conditions: 2.83 Vrms / 10 cm in 1 cc box

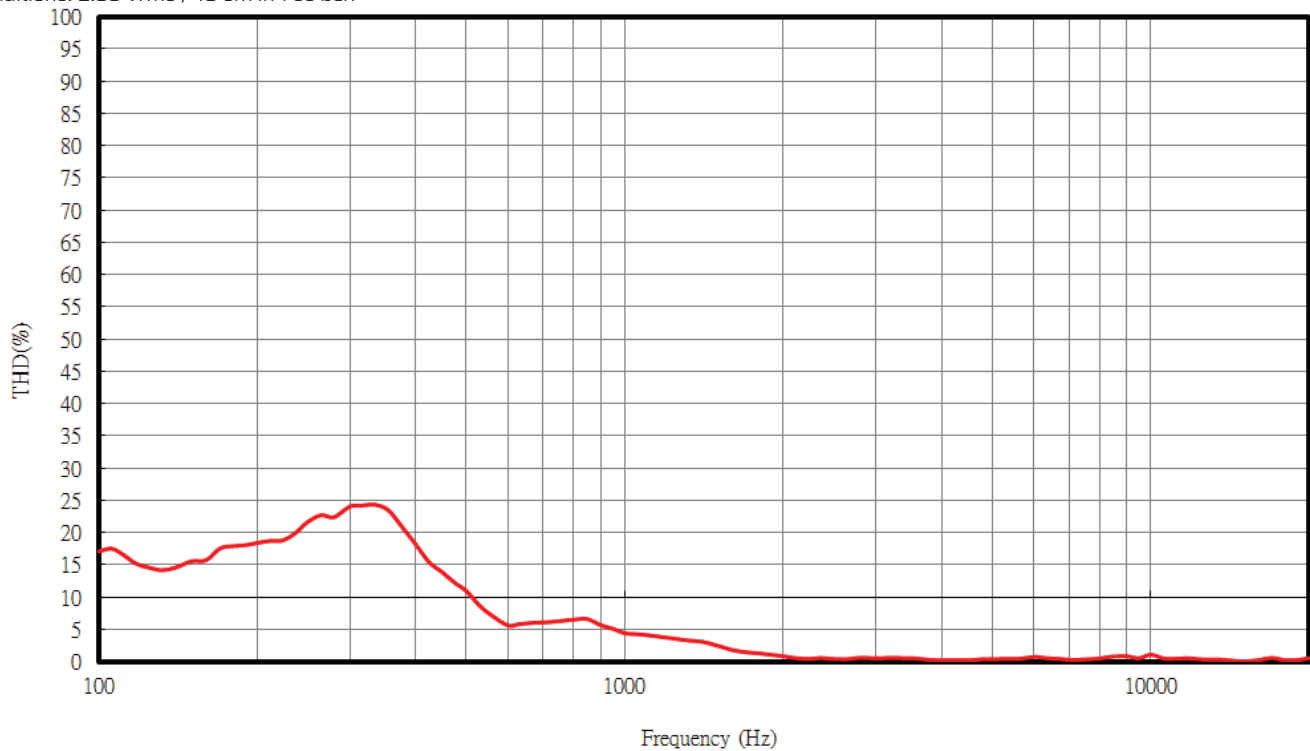

## PACKAGING

units: mm

Tray QTY: 100 pcs per tray  
 Carton Size: 470 x 300 x 310 mm  
 Carton QTY: 5,000 pcs per carton

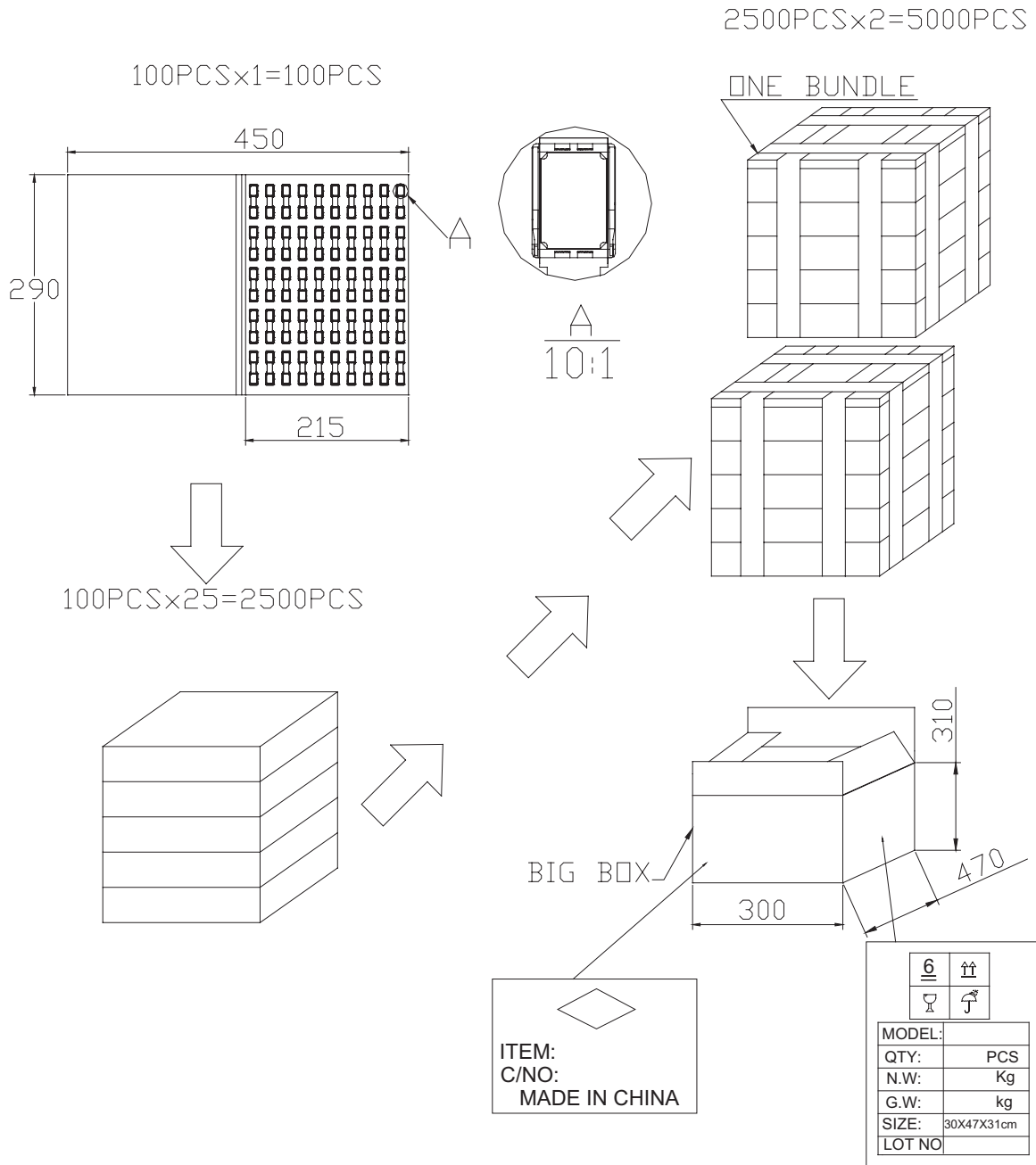

## REVISION HISTORY

rev.	description	date
1.0	initial release	03/22/2023
1.01	CUI Devices rebranded to Same Sky	09/11/2024

The revision history provided is for informational purposes only and is believed to be accurate.



Same Sky offers a one (1) year limited warranty. Complete warranty information is listed on our website.

Same Sky reserves the right to make changes to the product at any time without notice. Information provided by Same Sky is believed to be accurate and reliable. However, no responsibility is assumed by Same Sky for its use, nor for any infringements of patents or other rights of third parties which may result from its use.

Same Sky products are not authorized or warranted for use as critical components in equipment that requires an extremely high level of reliability. A critical component is any component of a life support device or system whose failure to perform can be reasonably expected to cause the failure of the life support device or system, or to affect its safety or effectiveness.

[sameskydevices.com](https://www.sameskydevices.com)