

## RFID System V680S Series

RFID Conforming to ISO/IEC 18000-3 (15693)



» Easy Operation using a web browser

» 3 in 1 RFID: Antenna, Amplifier & Controller

» Easy Connection via Ethernet

# OMRON Prom

Over 25 Years of History  
and Experience

Experience in all sectors of  
Transportation Manufacturing.  
Bringing High quality to your  
Manufacturing Process.

Industry-leading service for  
RFID system with over 25 years of  
experience.



## Introduction of high reliability of the RFID system

You can see the backbone of high reliability in the video by  
reading the 2D code using the bar code reader function of  
your smartphone or tablet.

# ises 2 Trusts.

## Radio Regulations Compliance for More than 50 Countries

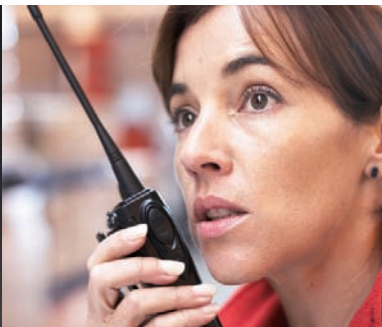

Radio waves for mobile phone, TV, and Industrial Components are national public goods. RFID system must comply with Radio Regulations.

Continued Compliance that our products can comply with Radio Regulations in more countries as global standards for RFID system.

Japan
Europe
Americas (United States, Canada, Mexico, Brazil)
Asia (China, South Korea, Taiwan, Philippines, Vietnam, Thailand, Singapore, Indonesia, Malaysia, India)
Oceania (Australia, New Zealand)

Contact your OMRON sales representative for details on whether application is supported in other countries. The latest information on the status of certification for radio regulations in various countries can be confirmed on the OMRON website.

# Simple 3 in 1 RFID Featuring the 3 "Easy"

3in1 **Plus+** Ethernet  
RFID



CONTROLLER

ANTENNA

AMPLIFIER

RFID  
V680

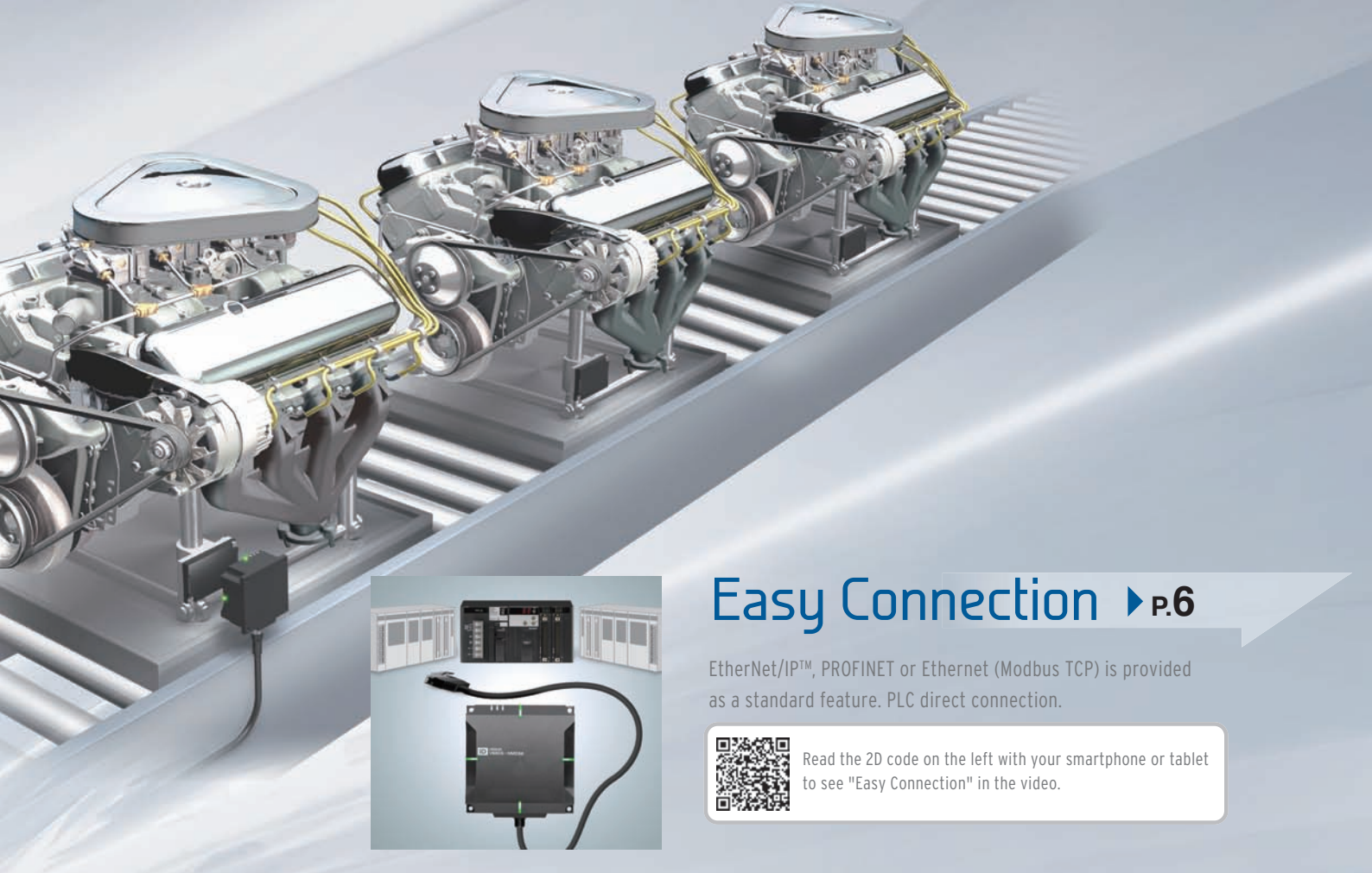

## Easy Connection ▶ P.6

EtherNet/IP™, PROFINET or Ethernet (Modbus TCP) is provided as a standard feature. PLC direct connection.



Read the 2D code on the left with your smartphone or tablet to see "Easy Connection" in the video.

## Easy Installation ▶ P.7

Stable communications are possible just by installing within a specified range.



Read the 2D code on the left with your smartphone or tablet to see "Easy Installation" in the video.

## Easy Operation ▶ P.8

The Interface using a web browser enables setting for reading/writing data without special software.



Read the 2D code on the left with your smartphone or tablet to see "Easy Operation" in the video.

# system S Series

EtherNet/IP™ is the trademarks of ODVA.

Microsoft product screen shots reprinted with permission from Microsoft Corporation.

The product photographs and figures that are used in this catalog may vary somewhat from the actual products.

Other company names and product names in this document are the trademarks or registered trademarks of their respective companies.

# Easy Connection

## Simple system configuration

Connect with just one cable via built-in Ethernet

### One Connection

Embedded Ethernet I/F realizes just one connection to the system without any network converter. Wiring work can be reduced.

### Easy Programming

3 types of industrial Ethernet protocols enable to connect any type of PLC with easy programming.



### Easy System Expansion

Multiple Reader/Writers can be easily connected by using a Switching HUB. System design and system expansion can be configured easily.

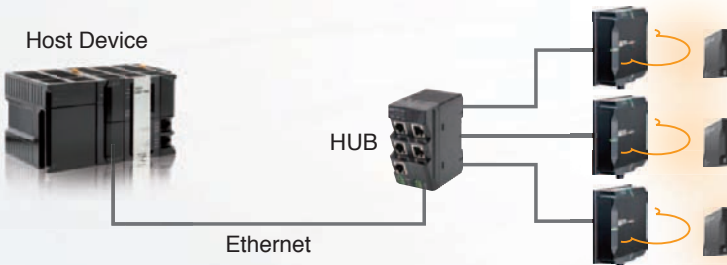

### Plus+

The Connection Procedure Manual for OMRON NJ Series and CJ Series is available.

Note : Contact your OMRON sales representative for the Connection Procedure Manual.



Note: Power must be supplied to the Reader/Writer. Refer to the V680S Series User's Manual (Cat. No. Z339 or Z353) for details.

# Easy Installation

## Easy to find the best installation location

Communication Diagnostic via LED status indicators

### Visualized Communications Status

On-site operators can easily check the communications status with the indicators of the Reader/Writer. The indicators using easy-to-see high-brightness LED can be easily seen from a distance.

Good



Error



Plus+

Communications status can be checked from **four directions**.

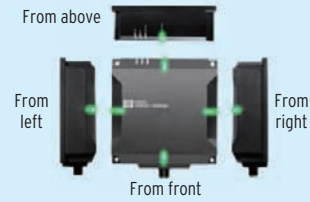

### Diagnosis of Communications

The Reader/Writer measures the communications signal and ambient noise levels to diagnose its stability, then indicates in LED and report to Host System. Easily and quickly checks the proper installation of the system, and helps to reduce startup time. This can be used for preventing errors during operation.

Warning

Indicates "Warning" states communication in yellow.

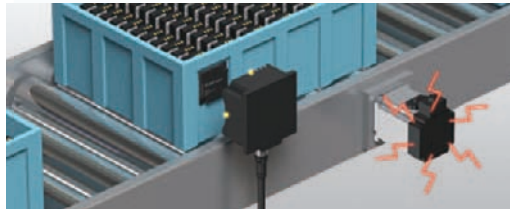

Note: 1. Communication Diagnostic is disabled in the default settings.  
2. The communication time is longer when enabling Communication Diagnostic.  
For details, refer to the User's Manual (Cat. No. Z339 or Z353).

### Interrogation Zone Extended Mode

Can control multiple Reader/Writers by sending just one command.

The Reader/Writers installed on both sides of the conveyor can access the RF Tags on the pallets even if the pallets are not placed with the same orientation.

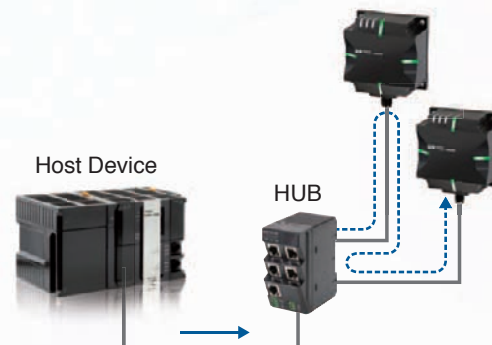
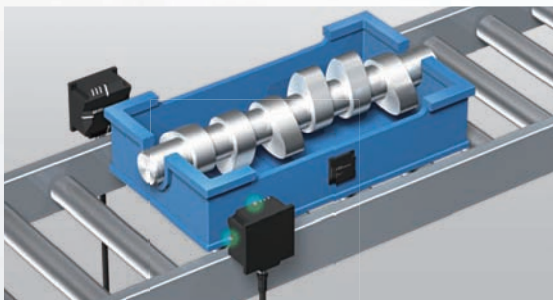

# Easy Operation

No special software nor expert RFID knowledge required

Operate via web browser on your computer

## WEB Browser I/F

Enable all parameter settings, execute RF Tag communications, and check the operation log anywhere by just connecting the computer.



## Easy Troubleshooting

Up to 2000 communication results are stored and guidance for the "Warning" results is provided. Can be quickly recovered from trouble without expert knowledge.

### List

Latest 2,048 communication results are logged and checked.



### Guidance window

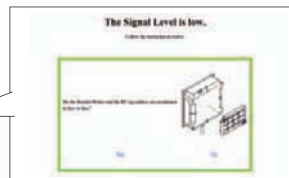

Troubleshoot is also available in the "Warning" results.

### Graph

Diagnostic results can be shown by the graph. Analysis time to identify the cause of unstable communication can be reduced by checking the time-series signal and noise levels. The results can be output to CSV files.



Plus+

## Four Language Support

Select from four languages: English, Chinese, Korean and Japanese.

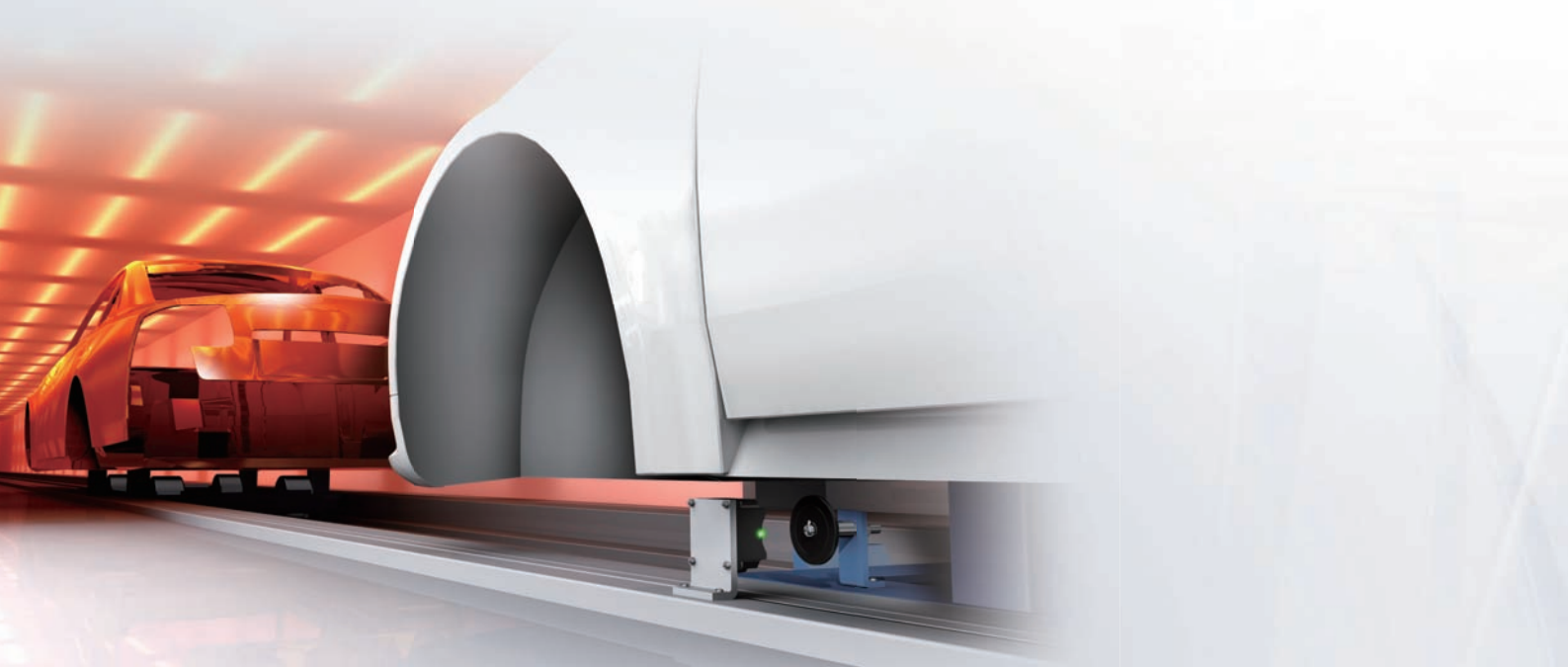



# V680S Series RF Tag

Contributes to shorter set-up time and more stable operation  
Versatile selection, IPx9K support, and longer communication range



## Easy to Select Suitable RF Tag for Your Application

V680S RF Tag series offers 8 kinds of full combinations based on Communication Range, Mounting Materials, Memory Sizes. Making it Easy to find the suitable RF Tag for your application.

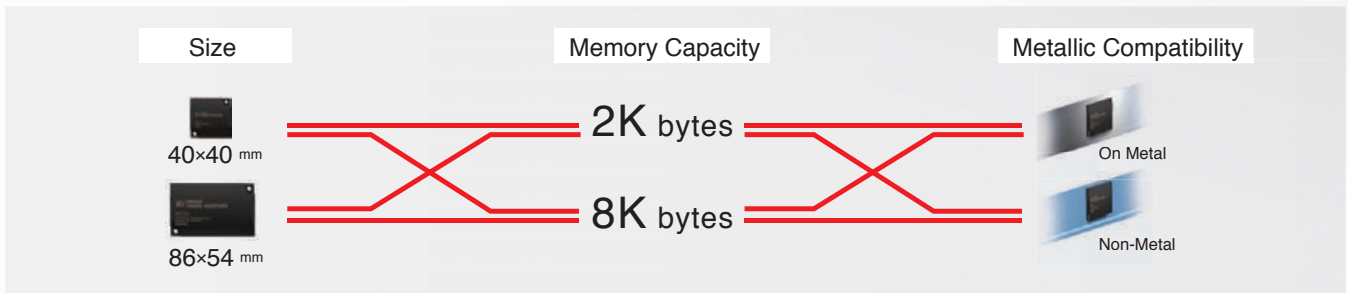

## Durable to High-temperature Wash Down : IP68 + IPx9K\*1 Support

RF Tag is molded by PPS resin which has superior oil and chemical resistance specification. It can be washed-down by a steam cleaner without removing from the pallet.

\*1. IPx9K is a protection standard regarding high temperature and high-pressure water.



## Longer Communication Range\*2

V680S series RF Tags are optimally designed to be used with V680S series Reader/Writers. Communication Range are up to 30% longer than those of existing models. This enables more flexible system design.

Up to 30% longer than existing model

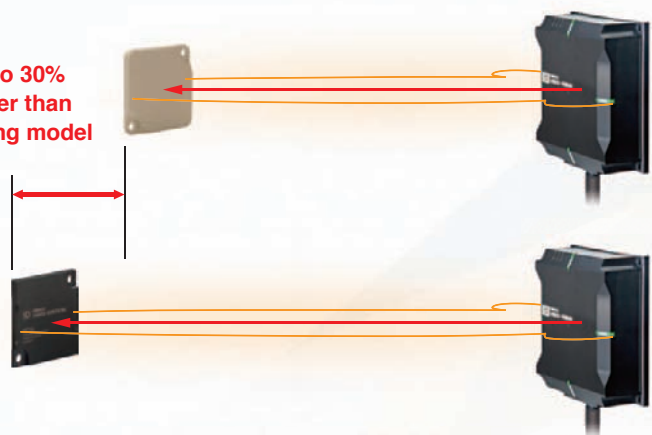

## Combination Examples

Size	Memory Capacity	Reader/Writer	Communication Range	
			Existing Model	V680S series
40×40 mm (40 mm×40 mm×5 mm)	8K bytes	V680S-HMD64-ETN	V680-D8KF67 5.0 to 50.0 mm	V680S-D8KF67 5.0 to 65.0 mm
86×54 mm (86 mm×54 mm×10 mm)	8K bytes	V680S-HMD66-ETN	V680-D8KF68A 10.0 to 100.0 mm	V680S-D8KF68 10.0 to 115.0 mm

\*2. When using some combinations of V680S series RF Tag and V680S series Reader/Writer.

## System Configuration

The below shows the configuration for 1 to 1 connection. Multiple Reader/Writers can be connected by using a Switching HUB.

### EtherNet/IP, PROFINET

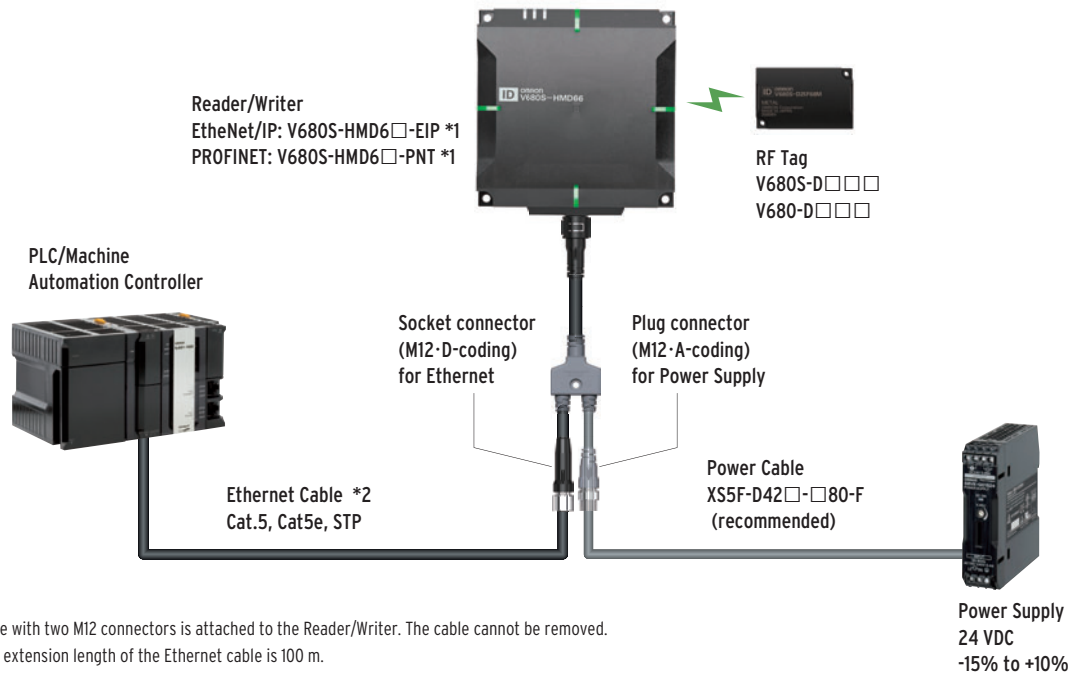

\*1. The 0.5 m cable with two M12 connectors is attached to the Reader/Writer. The cable cannot be removed.

\*2. The maximum extension length of the Ethernet cable is 100 m.

### Modbus TCP

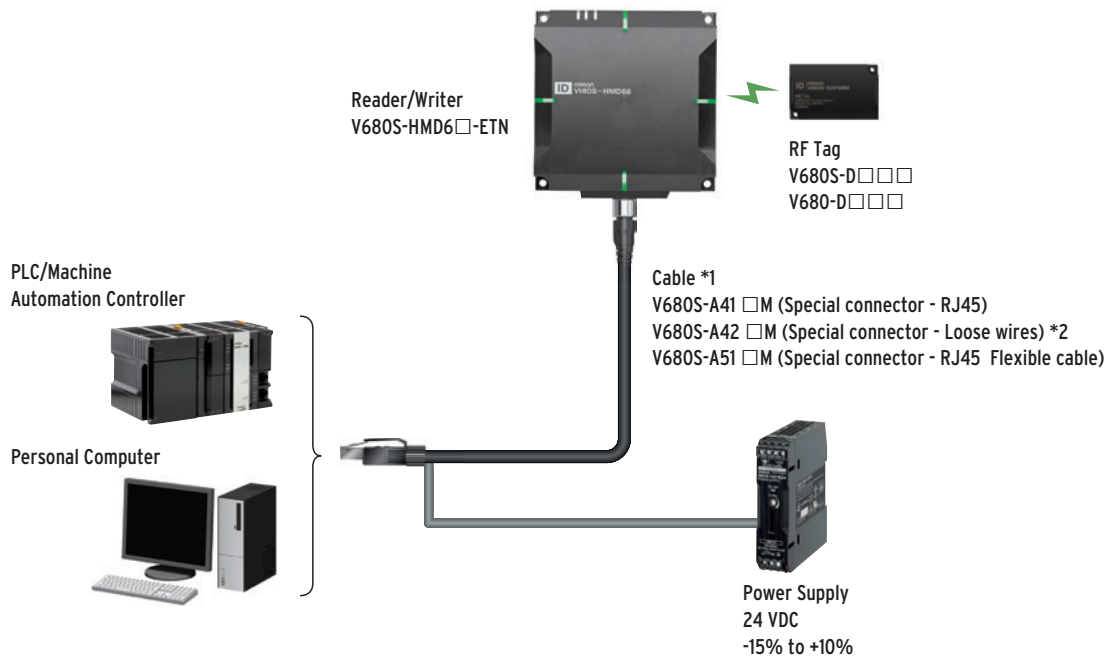

Note.

The cable can be extended up to 60 m by using the Extension Cable V680S-A40 □M (cable length: 10/20/50 m) or V680S-A50 □M (Flexible cable, cable length: 2/10/20m).

Use the extension cable between the Reader/Writer and cable.

Only one extension cable can be used.





\*1. The length of the Cable V680S-A41 □M/-A42 □M/-A51 □M is 2, 5, or 10 m.

\*2. The end of the cable should be prepared before connecting.

# Reader/Writer – RF Tag Communication Range Table

## V680S series RF Tag (2K bytes/8K bytes)

(Unit: mm)







RF Tag			Reader/Writer		
Model	Installation	V680S-HMD63-□□□	V680S-HMD64-□□□	V680S-HMD66-□□□	
		 50×50×30	 75×75×40	 120×120×40	
 40×40×5	V680S-D□KF67	nonmetallic surface	7.0 to 40.0	5.0 to 65.0	7.0 to 85.0
	V680S-D□KF67M	metallic surface	6.0 to 30.0	3.0 to 40.0	4.0 to 45.0
 86×54×10	V680S-D□KF68	nonmetallic surface	*	7.5 to 75.0	10.0 to 115.0
	V680S-D□KF68M	metallic surface	*	5.5 to 55.0	7.5 to 75.0

Note: The data above table shows the communication ranges for both Read and Write operation.

\* This combination is not guaranteed due to the size mismatch between the Reader/Writer and RF Tag.

## V680 series RF Tag (1K bytes)

(Unit: mm)

RF Tag			Reader/Writer		
Model	Installation	V680S-HMD63-□□□	V680S-HMD64-□□□	V680S-HMD66-□□□	
		 50×50×30	 75×75×40	 120×120×40	
 φ20×2.7	V680-D1KP54T	nonmetallic surface	0.0 to 24.0 (0.0 to 20.0)	0.0 to 33.0 (0.0 to 28.0)	0.0 to 45.0 (0.0 to 38.0)
 34×34×3.5	V680-D1KP66T	nonmetallic surface	0.0 to 30.0 (0.0 to 25.0)	0.0 to 47.0 (0.0 to 42.0)	0.0 to 64.0 (0.0 to 57.0)
	V680-D1KP66MT	metallic surface	0.0 to 25.0 (0.0 to 20.0)	0.0 to 35.0 (0.0 to 30.0)	0.0 to 37.0 (0.0 to 30.0)
 95×36.5×6.5	V680-D1KP66T-SP	nonmetallic surface	0.0 to 25.0 (0.0 to 20.0)	0.0 to 42.0 (0.0 to 37.0)	0.0 to 59.0 (0.0 to 52.0)
 φ80×10	V680-D1KP58HTN	nonmetallic surface	*	7.5 to 75.0 (7.5 to 75.0)	10.0 to 90.0 (10.0 to 80.0)

Note: The data above table shows the communication ranges for both Read and Write operation.

\* This combination is not guaranteed due to the size mismatch between the Reader/Writer and RF Tag.

# V680S Series



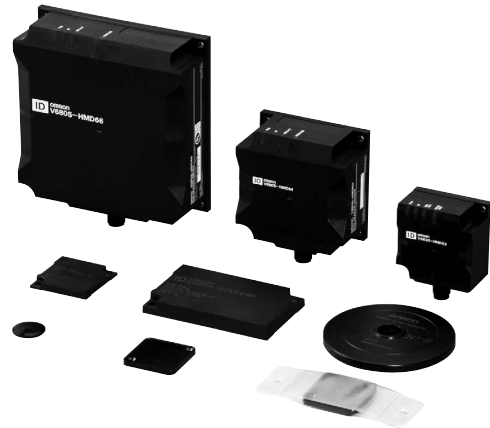

## 3 in 1 RFID: Antenna, Amplifier & Controller

- Conforms to ISO/IEC 18000-3 (15693).
- Standard-feature Ethernet (EtherNet/IP, PROFINET, Modbus TCP) enables easy connection with one cable.
- Easy installation and "visualized" communications status minimize startup work and downtime.
- WEB browser can be used for setting, monitoring, and communications with RF Tags.







## Ordering Information

### Reader/Writer





Appearance	Size	Network	Model
	50 × 50 × 30 mm	EtherNet/IP	V680S-HMD63-EIP <a href="#">NEW</a>
		PROFINET	V680S-HMD63-PNT <a href="#">NEW</a>
	75 × 75 × 40 mm	EtherNet/IP	V680S-HMD64-EIP <a href="#">NEW</a>
		PROFINET	V680S-HMD64-PNT <a href="#">NEW</a>
	120 × 120 × 40 mm	EtherNet/IP	V680S-HMD66-EIP <a href="#">NEW</a>
		PROFINET	V680S-HMD66-PNT <a href="#">NEW</a>
	50 × 50 × 30 mm	Modbus TCP (TCP/IP)	V680S-HMD63-ETN <a href="#">NEW</a>
	75 × 75 × 40 mm		V680S-HMD64-ETN
	120 × 120 × 40 mm		V680S-HMD66-ETN

## RF Tag V680S-series

Type	Memory capacity	Appearance	Size	Installation	Model
Battery-less	2 K bytes		40 × 40 × 5 mm	For flush mounting on metallic surface	<b>V680S-D2KF67M</b>
				For flush mounting on nonmetallic surface	<b>V680S-D2KF67</b>
		86 × 54 × 10 mm	For flush mounting on metallic surface	<b>V680S-D2KF68M</b>	
			For flush mounting on nonmetallic surface	<b>V680S-D2KF68</b>	
	8 K bytes		40 × 40 × 5 mm	For flush mounting on metallic surface	<b>V680S-D8KF67M *</b>
				For flush mounting on nonmetallic surface	<b>V680S-D8KF67 *</b>
		86 × 54 × 10 mm	For flush mounting on metallic surface	<b>V680S-D8KF68M *</b>	
			For flush mounting on nonmetallic surface	<b>V680S-D8KF68 *</b>	



\* V680S-D8KF6□M/V680S-D8KF6□ can be used with V680S series Reader/Writer version 2.00 or higher.

## V680-series

Type	Memory capacity	Appearance	Size	Installation	Model
Battery-less	1 K bytes		20 dia. × 2.7 mm	For flush mounting on nonmetallic surface	<b>V680-D1KP54T</b>
			34 × 34 × 3.5 mm	For flush mounting on metallic surface	<b>V680-D1KP66MT</b>
For flush mounting on nonmetallic surface				<b>V680-D1KP66T</b>	
Environment-resistant type Battery-less			95 × 36.5 × 6.5 mm	For flush mounting on nonmetallic surface	<b>V680-D1KP66T-SP</b>
High-temperature type Battery-less		80 dia. × t10 mm	For mounting with special attachment	<b>V680-D1KP58HTN</b>	



**Note:** V680 series 8K-byte RF Tag can communicate with V680S series Reader/Writer.  
For details, contact your OMRON representative.

## RF Tag Attachment

Type	Appearance	Model
For the V680-D1KP66T		<b>V600-A86</b>
For the V680-D1KP58HTN		<b>V680-A80</b>
For the V680-D1KP54T		<b>V700-A80</b>

## Connector Cover

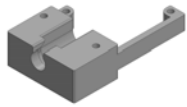
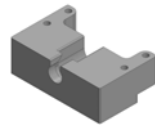
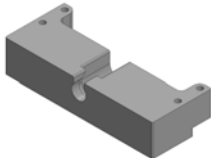
Consider using the following components to improve the vibration and impact resistance of the antenna or cable.

Type	Fixing method	Material	Model	Appearance	Applicable reader/writer
Standard type	Fixing screws in four locations, with two locations fixed with reader/writer mounting screws (*1)	POM	V680S-A63		V680S-HMD63-ETN
			V680S-A64		V680S-HMD64-ETN
			V680S-A66		V680S-HMD66-ETN
Slim type	Fixing screws in two locations (*2)	PBT	V680S-A63-S		V680S-HMD63-ETN V680S-HMD63-EIP
			V680S-A64-S		V680S-HMD64-ETN V680S-HMD66-ETN V680S-HMD64-EIP V680S-HMD66-EIP

\*1 V680S-A63/A64/A66 includes four mounting holes for fixing.

When mounting with a reader/writer already installed, or when no mounting holes for a new connector cover are available other than the reader/writer mounting holes, the connector cover can be fixed in two locations with the same mounting holes used for the reader/writer.

This makes it possible to install the connector cover without the need for additional mounting holes.

When tightening the products together in two locations, use the longer screw for the thicker part of the connector cover being tightened (thickness: 11.2 mm for V680S-A63, 6 mm for 680S-A64/A66).



\*2 In addition to the reader/writer mounting holes, two mounting holes are required for the connector cover.

**Note:** For assemblies with an antenna, download and review the outline drawings available on the OMRON website.

## Cable

### Recommended Ethernet Cable for EtherNet/IP and PROFINET (Connection between Host Device and Reader/Writer)

Use STP (shielded twisted-pair) cable of category 5 or higher.

Item	Cable length (m) *	Model	
Wire Gauge and Number of Pairs: AWG22, 2-pair Cable	 Rugged type Cable with Connectors on Both Ends (M12 Straight/RJ45)	0.3	XS5W-T421-AMC-K
		0.5	XS5W-T421-BMC-K
		1	XS5W-T421-CMC-K
		2	XS5W-T421-DMC-K
		5	XS5W-T421-GMC-K
		10	XS5W-T421-JMC-K
	 Rugged type Cable with Connectors on Both Ends (M12 Right-angle/RJ45)	0.3	XS5W-T422-AMC-K
		0.5	XS5W-T422-BMC-K
		1	XS5W-T422-CMC-K
		2	XS5W-T422-DMC-K
	5	XS5W-T422-GMC-K	
	10	XS5W-T422-JMC-K	

\* Rugged type cables length 0.3, 0.5, 1, 2, 3, 5, 10 and 15m are available.



**Note:** For details, refer to the Industrial Ethernet Connectors Catalog (Cat.No.G019).

## Recommended Power Cable for EtherNet/IP and PROFINET (Connection between Power Supply and Reader/Writer) XS5F-D42□-□80-□



Cable specifications	Cable length L (m)	Cable outer diameter (mm)	Straight Connectors	Angled Connectors	Minimum order
			Model		
Fire-retardant, Robot cable	1	6	XS5F-D421-C80-F	XS5F-D422-C80-F	10
	2		XS5F-D421-D80-F	XS5F-D422-D80-F	5
	3		XS5F-D421-E80-F	XS5F-D422-E80-F	
	5		XS5F-D421-G80-F	XS5F-D422-G80-F	
	10		XS5F-D421-J80-F	XS5F-D422-J80-F	1

**Note:** For details, refer to the Industrial Connectors Catalog (Cat. No. X082).

## Cable for Modbus TCP (Connection between Host Device and Reader/Writer)

Type	Appearance	Length	Model
Special connector – RJ45		2 m	V680S-A41 2M
		5 m	V680S-A41 5M
		10 m	V680S-A41 10M
Special connector – RJ45 (Flexible cables)		2 m	V680S-A51 2M
		5 m	V680S-A51 5M
		10 m	V680S-A51 10M
Special connector – Loose wires		2 m	V680S-A42 2M
		5 m	V680S-A42 5M
		10 m	V680S-A42 10M

## Extension Cable for Modbus TCP (Connection between Host Device and Reader/Writer)

Type	Appearance	Length	Model
Special connector – Special connector		10 m	V680S-A40 10M
		20 m	V680S-A40 20M
		50 m	V680S-A40 50M
Special connector – Special connector (Flexible cables)		2 m	V680S-A50 2M
		10 m	V680S-A50 10M
		20 m	V680S-A50 20M

**Note: 1.** The extension cable can be used for the Reader/Writer for Modbus TCP V680S-HMD6□-ETN.

**2.** The cable can be extended up to 60 m by using an extension cable. Only one extension cable can be used.

## Industrial Switching Hubs (Recommended Hubs)

Type	Appearance	Functions	No. of ports	Model
Industrial Switching Hubs		Quality of Service (QoS): EtherNet/IP control data priority 10/100BASE-TX, Auto-Negotiation	5	W4S1-05D

## Ratings and Performance

### Reader/Writer EtherNet/IP, PROFINET

Item	Model	V680S-HMD63-EIP V680S-HMD63-PNT	V680S-HMD64-EIP V680S-HMD64-PNT	V680S-HMD66-EIP V680S-HMD66-PNT
Dimensions		50W × 50H × 30D (excluding protruding parts and cables)	75W × 75H × 40D (excluding protruding parts and cables)	120W × 120H × 40D (excluding protruding parts and cables)
Power supply voltage		24 VDC (–15% to +10%)		
Consumption current		0.2A max.		
Ambient operating temperature		–10 to +55 °C (with no icing)		
Ambient operating humidity		25% to 85% (with no condensation)		
Ambient storage temperature		–25 to 70 °C (with no icing)		
Ambient storage humidity		25% to 85% (with no condensation)		
Insulation resistance		20 MΩ min. (at 500 VDC) between cable terminals and case		
Dielectric strength		1,000 VAC, 50/60 Hz for 1 min between cable terminals and case		
Vibration resistance		No abnormality after application of 10 to 500 Hz, 1.5-mm double amplitude, acceleration: 100 m/s <sup>2</sup> , 10 sweeps in each of 3 axis directions (up/down, left/right, and forward/backward) for 11 minutes each		
Shock resistance		No abnormality after application of 500 m/s <sup>2</sup> , 3 times each in 6 directions (Total: 18 times)		
Degree of protection		IP67 (IEC 60529: 2001) Oil resistance equivalent to IP67F (JIS C 0920: 2003, Appendix 1) *		
Materials		Case: PBT resin, Filled resin: Urethane resin		
Mass		Approx. 240g	Approx. 390g	Approx. 760g
Installation method		Reader/Writer: Two M4 screws (Use a screw of 12 mm or more in length.) Branch cable joint: One M4 screws		
Host device communications interface		Ethernet 10BASE-T/100BASE-TX		
Host device communications protocol		EtherNet/IP, PROFINET		
Accessories		Instruction Sheet, Description of Regulations and Standard, IP address label		

\* Oil resistance has been tested using a specific oil as defined in the OMRON test method.

**Note:** The 0.5 m cable with two M12 connectors is attached to the Reader/Writer. The cable cannot be removed.

### Modbus TCP

Item	Model	V680S-HMD63-ETN	V680S-HMD64-ETN	V680S-HMD66-ETN
Dimensions		50W × 50H × 30D (excluding protruding parts)	75W × 75H × 40D (excluding protruding parts)	120W × 120H × 40D (excluding protruding parts)
Power supply voltage		24 VDC (–15% to +10%)		
Consumption current		0.2A max.		
Ambient operating temperature		–10 to +55 °C (with no icing)		
Ambient operating humidity		25% to 85% (with no condensation)		
Ambient storage temperature		–25 to 70 °C (with no icing)		
Ambient storage humidity		25% to 85% (with no condensation)		
Insulation resistance		20 MΩ min. (at 500 VDC) between cable terminals and case		
Dielectric strength		1,000 VAC, 50/60 Hz for 1 min between cable terminals and case		
Vibration resistance		No abnormality after application of 10 to 500 Hz, 1.5-mm double amplitude, acceleration: 100 m/s <sup>2</sup> , 10 sweeps in each of 3 axis directions (up/down, left/right, and forward/backward) for 11 minutes each		
Shock resistance		No abnormality after application of 500 m/s <sup>2</sup> , 3 times each in 6 directions (Total: 18 times)		
Degree of protection		IP67 (IEC 60529: 2001) Oil resistance equivalent to IP67F (JIS C 0920: 2003, Appendix 1) *1		
Materials		Case: PBT resin, Filled resin: Urethane resin		
Mass		Approx. 120g	Approx. 270g	Approx. 640g
Installation method		Two M4 screws (Use a screw of 12 mm or more in length.)		
Host device communications interface		Ethernet 10BASE-T/100BASE-TX		
Host device communications protocol		MODBUS TCP		
Accessories		Instruction sheet, Description of Regulations and Standard, IP address label, Ferrite core *2		

\*1 Oil resistance has been tested using a specific oil as defined in the OMRON test method.

\*2 Provided only with the V680S-HMD66-ETN.



## RF Tag

## V680S-series

## RF Tag (2K-byte Memory)

Item	Model	V680S-D2KF67	V680S-D2KF67M	V680S-D2KF68	V680S-D2KF68M
Memory capacity		2,000 bytes (user area)			
Memory type		FRAM			
Data Retention		10 years after writing (85 °C or less)			
Memory life		One trillion writes for each block (85 °C or less), Access frequency *1 : One trillion accesses			
Ambient operating temperature		-20 to 85 °C (with no icing)			
Ambient storage temperature		-40 to 125 °C (with no icing)			
Ambient operating humidity		35% to 85%			
Degree of protection		IP68 (IEC 60529:2001), Oil resistance equivalent to IP67G (JIS C 0920:2003, Appendix 1) *2. IPX9K (DIN 40 050)			
Vibration resistance		No abnormality after application of 10 to 2,000 Hz, 1.5-mm double amplitude, acceleration: 150 m/s <sup>2</sup> , 10 sweeps each in X, Y, and Z directions for 15 minutes each		No abnormality after application of 10 to 500 Hz, 1.5-mm double amplitude, acceleration: 100 m/s <sup>2</sup> , 10 sweeps each in X, Y, and Z directions for 11 minutes each	
Shock resistance		No abnormality after application of 500 m/s <sup>2</sup> , 3 times each in X, Y, and Z directions (Total: 18 times)			
Dimensions		40 × 40 × 5 mm (W × H × D)		86 × 54 × 10 mm (W × H × D)	
Materials		PPS resin			
Weight		Approx. 11.5 g	Approx. 12 g	Approx. 44 g	Approx. 46 g
Metal countermeasures		None	Provided	None	Provided

\*1 The number of accesses is the total number of reads and writes.

\*2 Oil resistance has been tested using a specific oil as defined in the OMRON test method.

Note: For details, refer to the User's Manual (Cat. No. Z339).

## RF Tag (8K-byte Memory)

Item	Model	V680S-D8KF67	V680S-D8KF67M	V680S-D8KF68	V680S-D8KF68M
Memory capacity		8,192 bytes (user area)			
Memory type		FRAM			
Data Retention		10 years after writing (85 °C or less)			
Memory life		One trillion writes for each block (85 °C or less), Access frequency *1 : One trillion accesses			
Ambient operating temperature		-20 to 85 °C (with no icing)			
Ambient storage temperature		-40 to 125 °C (with no icing)			
Ambient operating humidity		35% to 85%			
Degree of protection		IP68 (IEC 60529:2001), Oil resistance equivalent to IP67G (JIS C 0920:2003, Appendix 1) *2. IPX9K (DIN 40 050)			
Vibration resistance		No abnormality after application of 10 to 2,000 Hz, 1.5-mm double amplitude, acceleration: 150 m/s <sup>2</sup> , 10 sweeps each in X, Y, and Z directions for 15 minutes each		No abnormality after application of 10 to 500 Hz, 1.5-mm double amplitude, acceleration: 100 m/s <sup>2</sup> , 10 sweeps each in X, Y, and Z directions for 11 minutes each	
Shock resistance		No abnormality after application of 500 m/s <sup>2</sup> , 3 times each in X, Y, and Z directions (Total: 18 times)			
Dimensions		40 × 40 × 5 mm (W × H × D)		86 × 54 × 10 mm (W × H × D)	
Materials		PPS resin			
Weight		Approx. 11.5 g	Approx. 12 g	Approx. 44 g	Approx. 46 g
Metal countermeasures		None	Provided	None	Provided

\*1 The number of accesses is the total number of reads and writes.

\*2 Oil resistance has been tested using a specific oil as defined in the OMRON test method.

Note: For details, refer to the User's Manual (Cat. No. Z339).

**V680-series**  
**RF Tag (1K-byte Memory)**

Item	Model	V680-D1KP54T	V680-D1KP66T	V680-D1KP66MT	V680-D1KP66T-SP
Memory capacity		1,000 bytes (user area)			
Memory type		EEPROM			
Data retention time		10 years after writing (85 °C or less), 0.5 year after writing (85 °C to 125 °C) Total data retention at high temperatures exceeding 125 °C is 10 hours *1			10 years after writing (85 °C or less)
Write endurance		100,000 writes for each block (25 °C)			
Ambient operating temperature (during transmission)		-25 to 85 °C (with no icing)			During RF Tag communications: -25 to 70 °C (with no icing) Not during RF Tag communications: -40 to 110 °C (with no icing)
Ambient storage temperature (during data backup)		-40 to 125 °C (with no icing) Heat resistance: 1,000 thermal cycles each of 30 minutes at -10 °C/150 °C, High temperature storage: 1,000 hours at 150 °C *2 200 thermal cycles each of 30 minutes at -10 °C/180 °C, High temperature storage: 200 hours at 180 °C *3			-40 to 110 °C (with no icing)
Ambient operating humidity		35 to 95%			
Degree of protection		IP67 (IEC 60529:2001) Oil resistance equivalent to IP67G (JIS C 0920:2003, Appendix 1) *4	IP68 (IEC 60529:2001) Oil resistance equivalent to IP67G (JIS C 0920:2003, Appendix 1) *4		IP67
Vibration resistance		No abnormality after application of 10 to 2,000 Hz, 1.5-mm double amplitude, acceleration: 150 m/s <sup>2</sup> , 10 sweeps each in X, Y, and Z directions for 15 minutes each			
Shock resistance		No abnormality after application of 500 m/s <sup>2</sup> , 3 times each in X, Y, and Z directions (Total: 18 times)			
Appearance		20 dia. × 2.7 mm	34 × 34 × 3.5 mm		95 × 36.5 × 6.5 mm (excluding protruding parts)
Materials		PPS resin			Exterior: PFA fluororesin RF Tag filling: PPS resin
Weight		Approx. 2 g	Approx. 6 g	Approx. 7.5 g	Approx. 20 g
Metal countermeasures		None	None	Provided	None

\*1 After storing data at high temperatures, rewrite the data even if changes are not required. High temperatures are those exceeding 125 °C up to 180 °C.

\*2 150 °C heat resistance: The heat resistance has been checked at 150 °C for up to 1,000 hours, and thermal shock has been checked through testing 1,000 thermal cycles each of 30 minutes at -10/150 °C. (Test samples: 22, defects: 0)

\*3 180 °C heat resistance: The heat resistance has been checked at 180 °C for up to 200 hours, and thermal shock has been checked through testing 200 thermal cycles each of 30 minutes at -10 °C/180 °C. (Test samples: 22, defects: 0)

\*4 Oil resistance has been tested using a specific oil as defined in the OMRON test method.

**Note:** For details, refer to the User's Manual (Cat. No. Z339).

**RF Tag (1K-byte Memory with High-temperature Capability)**

Item	Model	V680-D1KP58HTN
Memory capacity		1,000 bytes (user area)
Memory type		EEPROM
Data Retention		10 years after writing (85 °C or less), 0.5 year after writing (85 °C to 125 °C) Total data retention at high temperatures exceeding 125 °C is 10 hours *1
Write Endurance		100,000 writes for each block (25 °C)
Ambient operating temperature (during transmission)		-25 to 85 °C (with no icing)
Ambient storage temperature (during data backup)		-40 to 250 °C (with no icing) *2 (Data retention: -40 to 125 °C) 1. 2,000 cycles of 30 minutes each between room temperature and 200 °C 2. 500 hours at 250 °C
Ambient storage humidity		No restrictions.
Degree of protection		IP67 (IEC 60529:2001) Oil resistance equivalent to IP67G (JIS C 0920:2003, Appendix 1) *3
Vibration resistance		No abnormality after application of 10 to 2,000 Hz, 1.5-mm double amplitude, acceleration: 150 m/s <sup>2</sup> , 10 sweeps each in X, Y, and Z directions for 15 minutes each
Shock resistance		No abnormality after application of 500 m/s <sup>2</sup> , 3 times each in X, Y, and Z directions (Total: 18 times)
Materials		PPS resin
Weight		Approx. 70 g

\*1. After storing data at high temperatures, rewrite the data even if changes are not required. High temperatures are those exceeding 125 °C up to 250 °C.

\*2 Storing RF Tags under high temperatures or under heat cycles will adversely affect the performance of the internal parts and the service life of the RF Tags. The RF Tag were placed in the following high temperatures and then evaluated in-house. It was confirmed that no problems occurred.









1. 2,000 cycles of 30 minutes each between room temperature and 200 °C.
2. 500 hours at 250 °C.

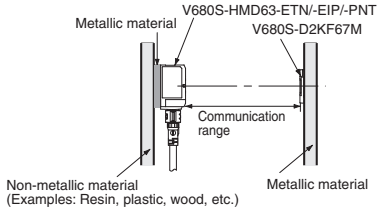

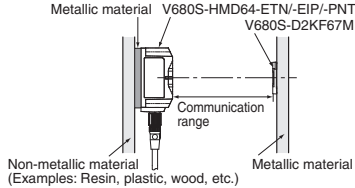

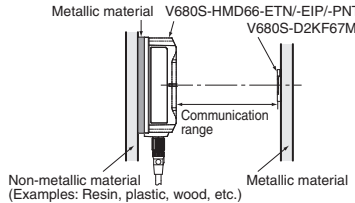
\*3 Oil resistance has been tested using a specific oil as defined in the OMRON test method.

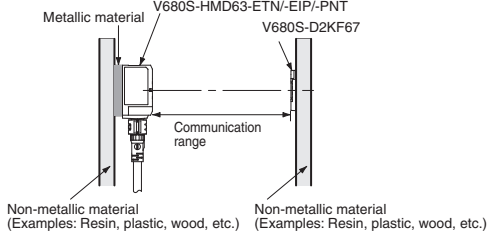
**Note:** For details, refer to the User's Manual (Cat. No. Z339, Z353 or Z354).

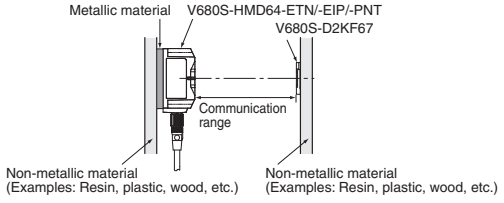
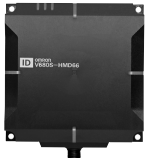
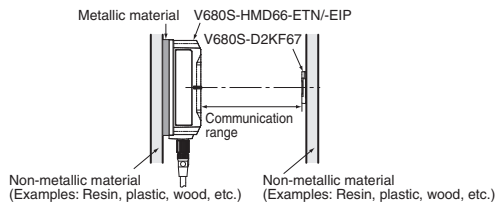

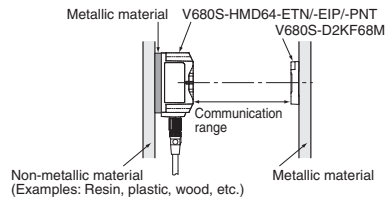

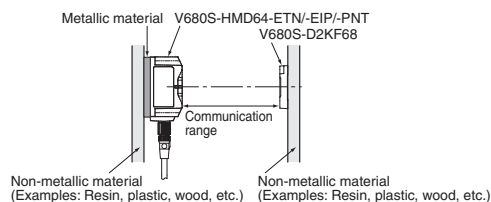



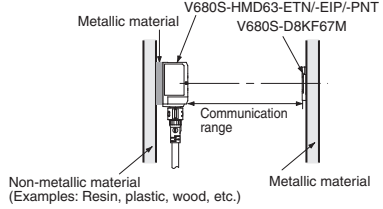

# Communication Specifications

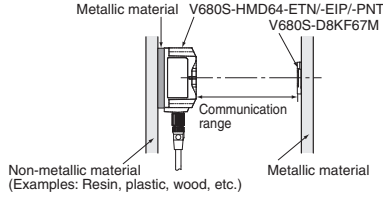

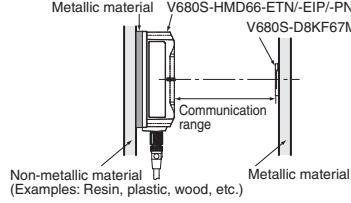

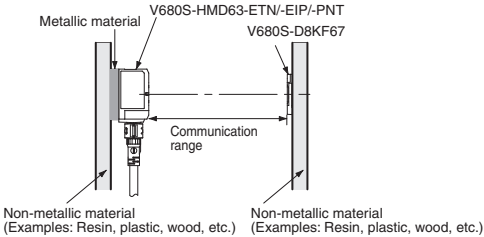

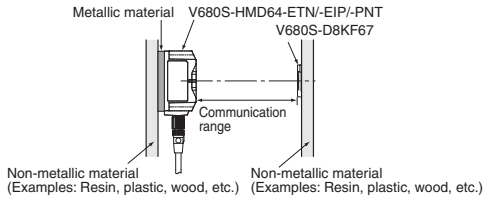
## V680S-series RF Tag (2K-byte Memory)

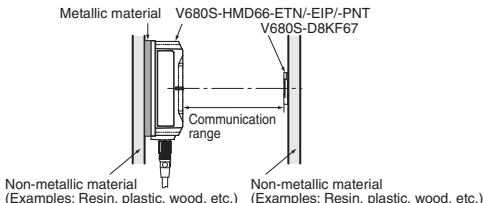
Combination		Function	Communication range (unit: mm)	RF Tag and Reader/Writer mounting conditions
RF Tag	Reader/Writer			
V680S-D2KF67M (mounted to metallic material)	V680S-HMD63-ETN/-EIP/-PNT 	Read/Write	6.0 to 30.0 (axis offset ±10)	
	V680S-HMD64-ETN/-EIP/-PNT 	Read/Write	3.0 to 40.0 (axis offset ±10)	
	V680S-HMD66-ETN/-EIP/-PNT 	Read/Write	4.0 to 45.0 (axis offset ±10)	
V680S-D2KF67 (mounted to non-metallic material)	V680S-HMD63-ETN/-EIP/-PNT 	Read/Write	7.0 to 40.0 (axis offset ±10)	
	V680S-HMD64-ETN/-EIP/-PNT 	Read/Write	5.0 to 65.0 (axis offset ±10)	
	V680S-HMD66-ETN/-EIP/-PNT 	Read/Write	7.0 to 85.0 (axis offset ±10)	



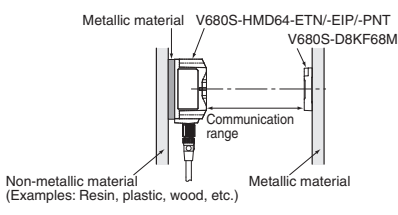



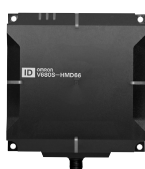

Combination		Function	Communication range (unit: mm)	RF Tag and Reader/Writer mounting conditions
RF Tag	Reader/Writer			
V680S-D2KF68M (mounted to metallic material)	V680S-HMD64-ETN/-EIP/-PNT 	Read/Write	5.5 to 55.0 (axis offset ±10)	
	V680S-HMD66-ETN/-EIP/-PNT 			
V680S-D2KF68 (mounted to non-metallic material)	V680S-HMD64-ETN/-EIP/-PNT 	Read/Write	7.5 to 75.0 (axis offset ±10)	
	V680S-HMD66-ETN/-EIP/-PNT 			

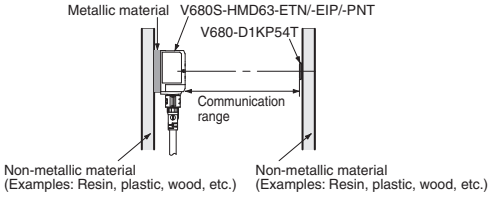

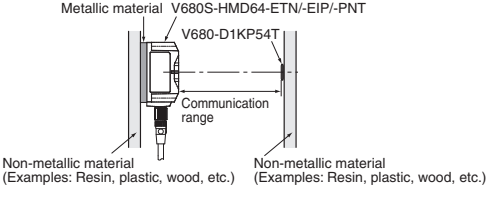
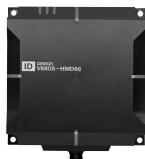
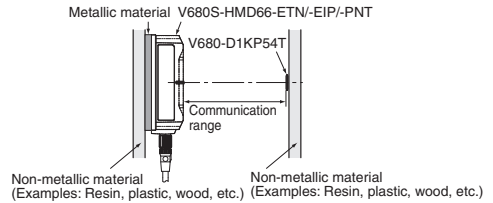

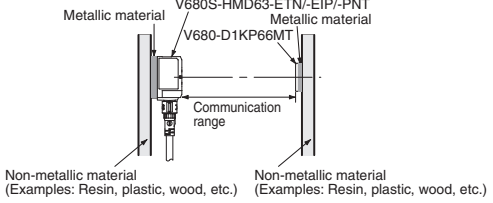
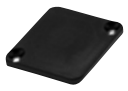

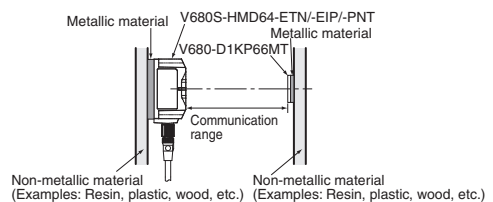

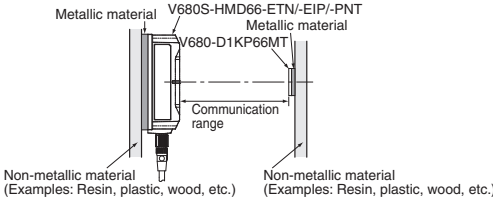

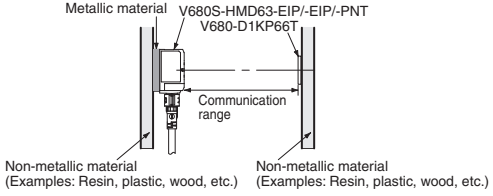
RF Tag (8K-byte Memory)

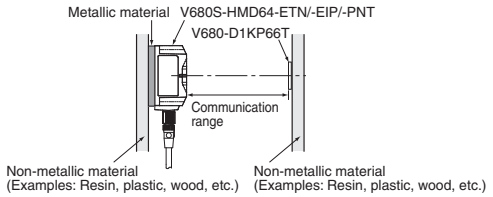
Combination		Function	Communication range (unit: mm)	RF Tag and Reader/Writer mounting conditions
RF Tag	Reader/Writer			
V680S-D8KF67M (mounted to metallic material)	V680S-HMD63-ETN/-EIP/-PNT 	Read/Write	6.0 to 30.0 (axis offset ±10)	
	V680S-HMD64-ETN/-EIP/-PNT 	Read/Write	3.0 to 40.0 (axis offset ±10)	
	V680S-HMD66-ETN/-EIP/-PNT 	Read/Write	4.0 to 45.0 (axis offset ±10)	
V680S-D8KF67 (mounted to non-metallic material)	V680S-HMD63-ETN/-EIP/-PNT 	Read/Write	7.0 to 40.0 (axis offset ±10)	
	V680S-HMD64-ETN/-EIP/-PNT 	Read/Write	5.0 to 65.0 (axis offset ±10)	
	V680S-HMD66-ETN/-EIP/-PNT 	Read/Write	7.0 to 85.0 (axis offset ±10)	

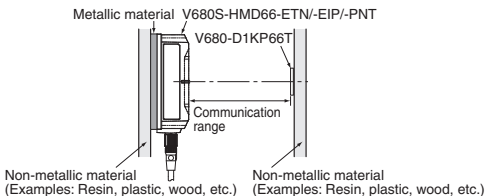
Combination		Function	Communication range (unit: mm)	RF Tag and Reader/Writer mounting conditions
RF Tag	Reader/Writer			
V680S-D8KF68M (mounted to metallic material)  	V680S-HMD64-ETN/-EIP/-PNT  	Read/Write	5.5 to 55.0 (axis offset ±10)	
	V680S-HMD66-ETN/-EIP/-PNT  			Read/Write
V680S-D8KF68 (mounted to non-metallic material)  	V680S-HMD64-ETN/-EIP/-PNT  	Read/Write	7.5 to 75.0 (axis offset ±10)	
	V680S-HMD66-ETN/-EIP/-PNT  			Read/Write

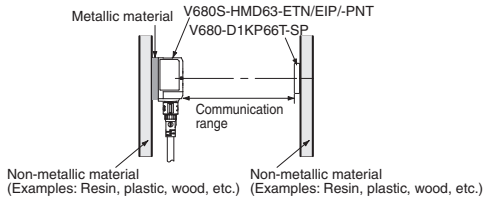

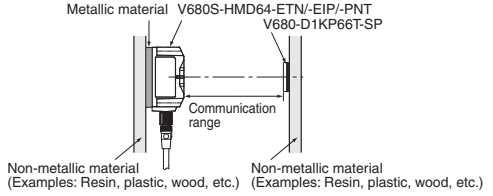

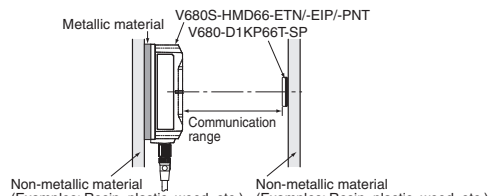
**V680-series**  
**RF Tag (1K-byte Memory)**

Combination		Function	Communication range (unit: mm)	RF Tag and Reader/Writer mounting conditions
RF Tag	Reader/Writer			
V680-D1KP54T (mounted to non-metallic material)	V680S-HMD63-ETN/-EIP/-PNT 	Read	0.0 to 24.0 (axis offset ±10)	
		Write	0.0 to 20.0 (axis offset ±10)	
	 V680S-HMD64-ETN/-EIP/-PNT 	Read	0.0 to 33.0 (axis offset ±10)	
		Write	0.0 to 28.0 (axis offset ±10)	
	V680S-HMD66-ETN/-EIP/-PNT 	Read	0.0 to 45.0 (axis offset ±10)	
		Write	0.0 to 38.0 (axis offset ±10)	
V680-D1KP66MT (mounted to metallic material)	V680S-HMD63-ETN/-EIP/-PNT 	Read	0.0 to 25.0 (axis offset ±10)	
		Write	0.0 to 20.0 (axis offset ±10)	
	 V680S-HMD64-ETN/-EIP/-PNT 	Read	0.0 to 35.0 (axis offset ±10)	
		Write	0.0 to 30.0 (axis offset ±10)	
	V680S-HMD66-ETN/-EIP/-PNT 	Read	0.0 to 37.0 (axis offset ±10)	
		Write	0.0 to 30.0 (axis offset ±10)	

Combination		Function	Communication range (unit: mm)	RF Tag and Reader/Writer mounting conditions
RF Tag	Reader/Writer			
V680-D1KP66T (mounted to non-metallic material)		Read	0.0 to 30.0 (axis offset $\pm 10$ )	
		Write	0.0 to 25.0 (axis offset $\pm 10$ )	
		Read	0.0 to 47.0 (axis offset $\pm 10$ )	
		Write	0.0 to 42.0 (axis offset $\pm 10$ )	
		Read	0.0 to 64.0 (axis offset $\pm 10$ )	
		Write	0.0 to 57.0 (axis offset $\pm 10$ )	
V680-D1KP66T-SP (mounted to non-metallic material)		Read	0.0 to 25.0 (axis offset $\pm 10$ )	
		Write	0.0 to 20.0 (axis offset $\pm 10$ )	
		Read	0.0 to 42.0 (axis offset $\pm 10$ )	
		Write	0.0 to 37.0 (axis offset $\pm 10$ )	
		Read	0.0 to 59.0 (axis offset $\pm 10$ )	
		Write	0.0 to 52.0 (axis offset $\pm 10$ )	

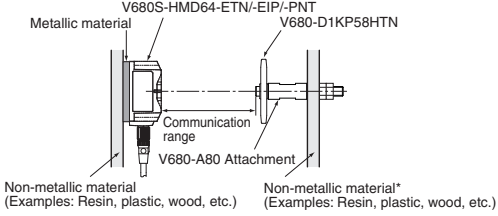

**RF Tag (1K-byte memory with High-temperature Capability)**

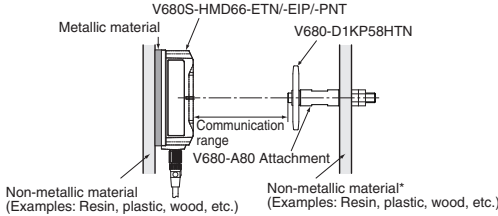
Combination		Function	Communication range (unit: mm)	RF Tag and Reader/Writer mounting conditions
RF Tag	Reader/Writer			
V680-D1KP58HTN (mounted with special attachment)  	V680S-HMD64-ETN/-EIP/-PNT  	Read	7.5 to 75.0 (axis offset ±10)	
		Write	7.5 to 75.0 (axis offset ±10)	
	V680S-HMD66-ETN/-EIP/-PNT  	Read	10.0 to 90.0 (axis offset ±10)	
		Write	10.0 to 80.0 (axis offset ±10)	

\* The communications range will decrease if the RF Tag is mounted on a metallic surface.  
 Refer to the Influence of Metal at Back Surface in the User's Manual (Cat. No. Z339 , Z353 or Z354) for details.

## Characteristic Data

### RF Tag Interrogation Zone (for Reference Only)

The values given for communications ranges are reference values. Refer to pages 19 to 25 for communications distance specifications. Communication range depends on the RF Tags, ambient temperature, surrounding metal, noise, and other factors. Carefully check the operation when installing a system.

#### V680S-series

#### RF Tag (2K-byte memory)

##### V680S-D2KF67

V680S-HMD63-□□□ and V680S-D2KF67  
(Back Surface: Metal)

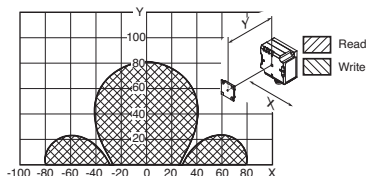

V680S-HMD64-□□□ and V680S-D2KF67  
(Back Surface: Metal)

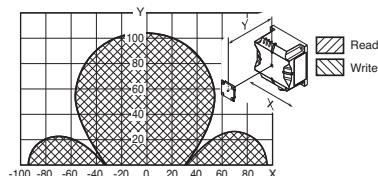

V680S-HMD66-□□□ and V680S-D2KF67  
(Back Surface: Metal)

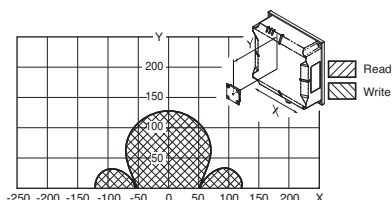

##### V680S-D2KF67M

V680S-HMD63-□□□ and V680S-D2KF67M  
(Back Surface: Metal) (Back Surface: Metal)

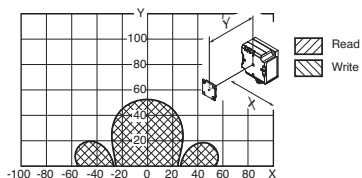

V680S-HMD64-□□□ and V680S-D2KF67M  
(Back Surface: Metal) (Back Surface: Metal)

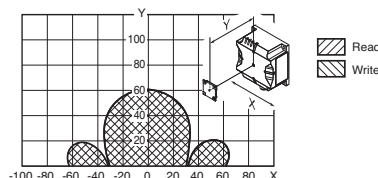

V680S-HMD66-□□□ and V680S-D2KF67M  
(Back Surface: Metal) (Back Surface: Metal)

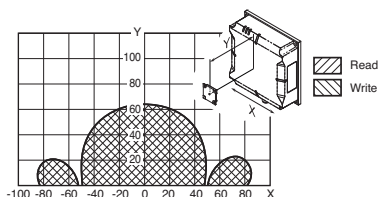

##### V680S-D2KF68

V680S-HMD64-□□□ and V680S-D2KF68  
(Back Surface: Metal) (Tag direction: Horizontal)

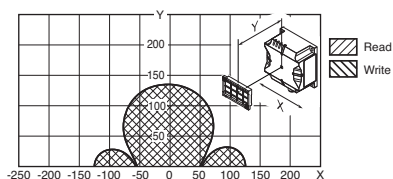

V680S-HMD64-□□□ and V680S-D2KF68  
(Back Surface: Metal) (Tag direction: Vertical)

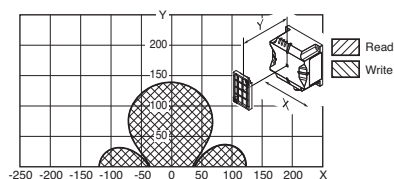

**V680S-D2KF68**

V680S-HMD66-□□□ and V680S-D2KF68  
(Back Surface: Metal) (Tag direction: Horizontal)

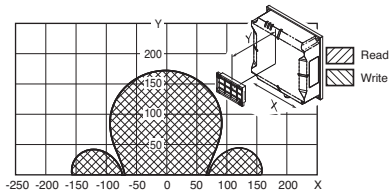

V680S-HMD66-□□□ and V680S-D2KF68  
(Back Surface: Metal) (Tag direction: Vertical)

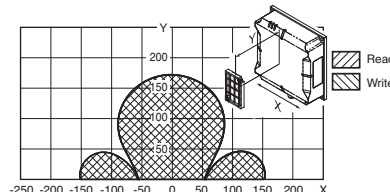

**V680S-D2KF68M**

V680S-HMD64-□□□ and V680S-D2KF68M  
(Back Surface: Metal) (Tag direction: Horizontal)

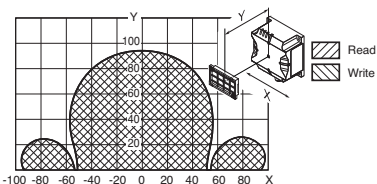

V680S-HMD64-□□□ and V680S-D2KF68M  
(Back Surface: Metal) (Tag direction: Vertical)

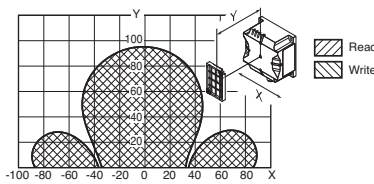

V680S-HMD66-□□□ and V680S-D2KF68M  
(Back Surface: Metal) (Tag direction: Horizontal)

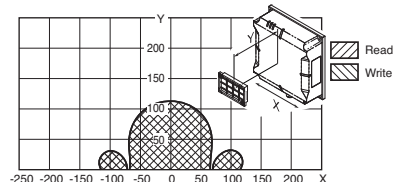

V680S-HMD66-□□□ and V680S-D2KF68M  
(Back Surface: Metal) (Tag direction: Vertical)

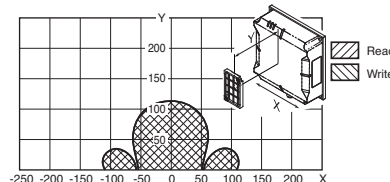

**RF Tag (8K-byte memory)**

**V680S-D8KF67**

V680S-HMD63-□□□ and V680S-D8KF67  
(Back Surface: Metal)

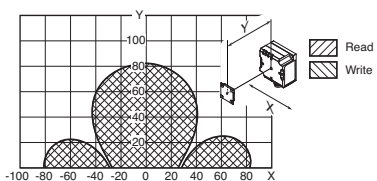

V680S-HMD64-□□□ and V680S-D8KF67  
(Back Surface: Metal)

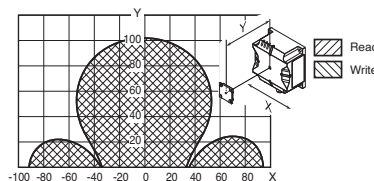

V680S-HMD66-□□□ and V680S-D8KF67  
(Back Surface: Metal)

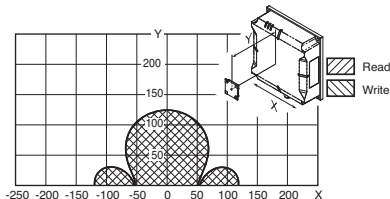

**V680S-D8KF67M**

V680S-HMD63-□□□ and V680S-D8KF67M  
(Back Surface: Metal) (Back Surface: Metal)

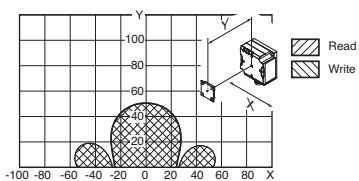

V680S-HMD64-□□□ and V680S-D8KF67M  
(Back Surface: Metal) (Back Surface: Metal)

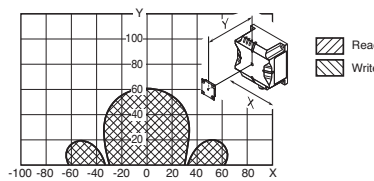

**V680S-D8KF67M**

V680S-HMD66-□□□ and V680S-D8KF67M  
(Back Surface: Metal) (Back Surface: Metal)

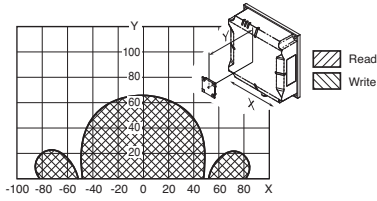

**V680S-D8KF68**

V680S-HMD64-□□□ and V680S-D8KF68  
(Back Surface: Metal) (Tag direction: Horizontal)

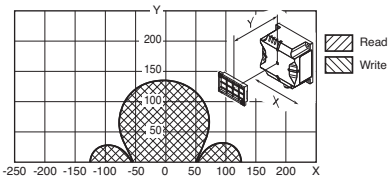

V680S-HMD64-□□□ and V680S-D8KF68  
(Back Surface: Metal) (Tag direction: Vertical)

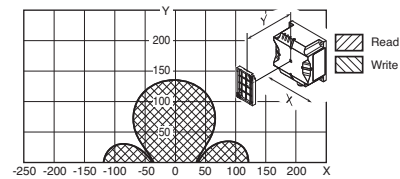

V680S-HMD66-□□□ and V680S-D8KF68  
(Back Surface: Metal) (Tag direction: Horizontal)

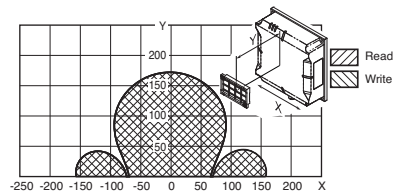

V680S-HMD66-□□□ and V680S-D8KF68  
(Back Surface: Metal) (Tag direction: Vertical)

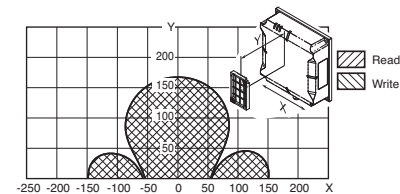

**V680S-D8KF68M**

V680S-HMD64-□□□ and V680S-D8KF68M  
(Back Surface: Metal) (Tag direction: Horizontal)

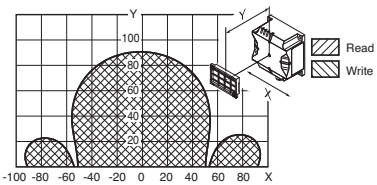

V680S-HMD64-□□□ and V680S-D8KF68M  
(Back Surface: Metal) (Tag direction: Vertical)

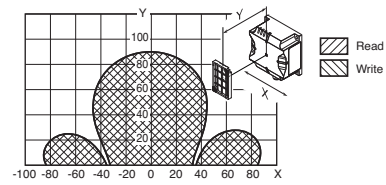

V680S-HMD66-□□□ and V680S-D8KF68M  
(Back Surface: Metal) (Tag direction: Horizontal)

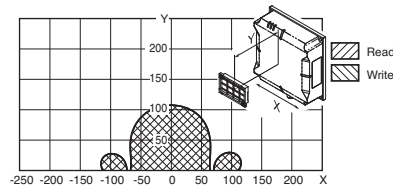

V680S-HMD66-□□□ and V680S-D8KF68M  
(Back Surface: Metal) (Tag direction: Vertical)

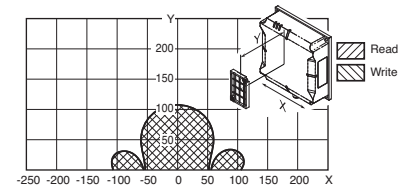

**V680-series**

**RF Tag (1K-byte memory)**

**V680-D1KP54T**

V680S-HMD63-□□□ and V680-D1KP54T  
(Back Surface: Metal)

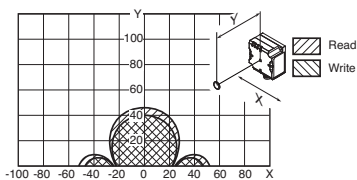

V680S-HMD64-□□□ and V680-D1KP54T  
(Back Surface: Metal)

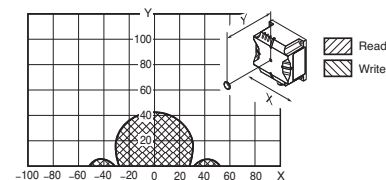

**V680-D1KP54T**

V680S-HMD66-□□□ and V680-D1KP54T  
(Back Surface: Metal)

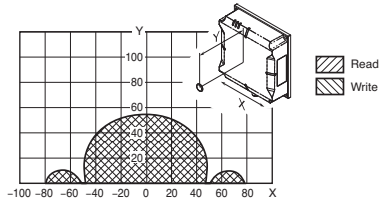

**V680-D1KP66T**

V680S-HMD63-□□□ and V680-D1KP66T  
(Back Surface: Metal)

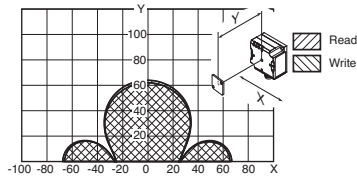

V680S-HMD64-□□□ and V680-D1KP66T  
(Back Surface: Metal)

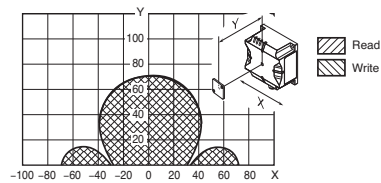

V680S-HMD66-□□□ and V680-D1KP66T  
(Back Surface: Metal)

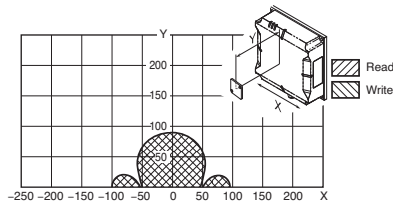

**V680-D1KP66MT**

V680S-HMD63-□□□ and V680-D1KP66MT  
(Back Surface: Metal) (Back Surface: Metal)

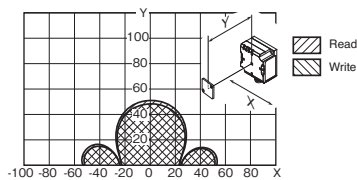

V680S-HMD64-□□□ and V680-D1KP66MT  
(Back Surface: Metal) (Back Surface: Metal)

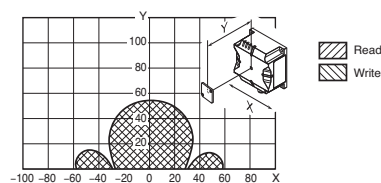

V680S-HMD66-□□□ and V680-D1KP66MT  
(Back Surface: Metal) (Back Surface: Metal)

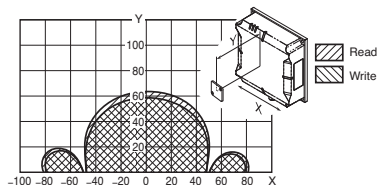

**V680-D1KP66T-SP**

V680S-HMD63-□□□ and V680-D1KP66T-SP  
(Back Surface: Metal)

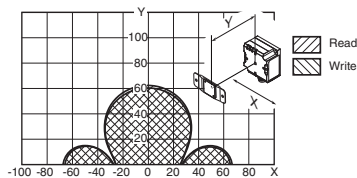

V680S-HMD64-□□□ and V680-D1KP66T-SP  
(Back Surface: Metal)

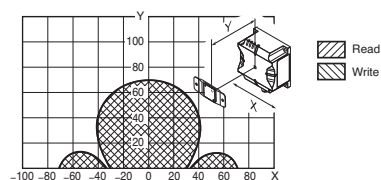

**V680-D1KP66T-SP**

V680S-HMD66-□□□ and V680-D1KP66T-SP  
(Back Surface: Metal)

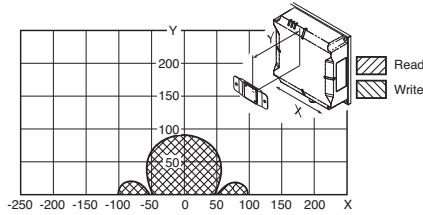

**V680-D1KP58HTN**

V680S-HMD64-□□□ and V680-D1KP58HTN  
(Back Surface: Metal) (with Attachment, V680-A80)

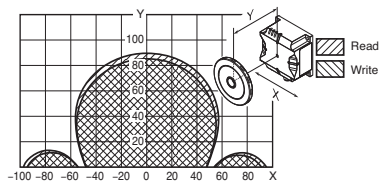

V680S-HMD66-□□□ and V680-D1KP58HTN  
(Back Surface: Metal) (with Attachment, V680-A80)

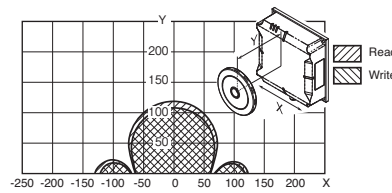

**RF Tag Communication Time (for Reference Only)**

The communication time is the time from when the Reader/Writer turns ON the RF signal until it receives the last bit of the response from the RF Tag.

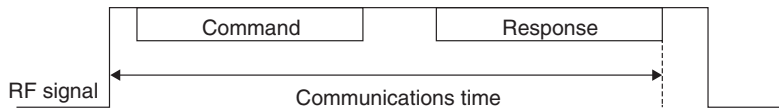

- RF signal: The radio wave that the Reader/Writer transmits to the RF Tag.  
The Reader/Writer turns ON this RF signal and then sends the command to start communications with the RF Tag.  
When the communications end, the Reader/Writer turns OFF the RF signal.
- Command: The command that the Reader/Writer sends to the RF Tag.
- Response: The response that the RF Tag returns to the Reader/Writer.

**V680S series**

**RF Tag (2k-byte Memory)**

V680S-HMD6□-□□□:  
V680S-D2KF6□ (M) (Communications speed setting: High speed)

Query	Communications time (ms) N: No. of bytes processed
Read	$T = 0.4N + 17.4$
Write (with verification)	$T = 1.0N + 51.9$
Write (without verification)	$T = 0.7N + 35.2$

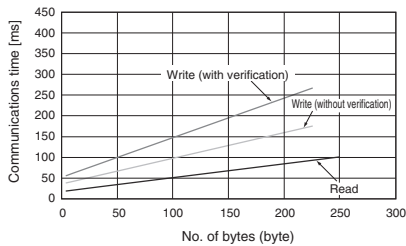

V680S-HMD6□-□□□:  
V680S-D2KF6□ (M) (Communications speed setting: Normal speed)

Query	Communications time (ms) N: No. of bytes processed
Read	$T = 0.9N + 18.7$
Write (with verification)	$T = 1.7N + 42.1$
Write (without verification)	$T = 0.9N + 32.0$

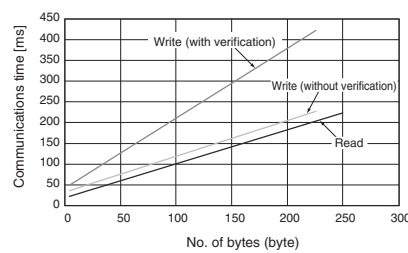

**RF Tag (8k-byte Memory)**

V680S-HMD6□-□□□:

V680S-D8KF6□ (M) (Communications speed setting: High speed)

Query	Communications time (ms) N: No. of bytes processed
Read	$T = 0.4N + 33.0$
Write (with verification)	$T = 0.9N + 95.1$
Write (without verification)	$T = 0.5N + 65.8$

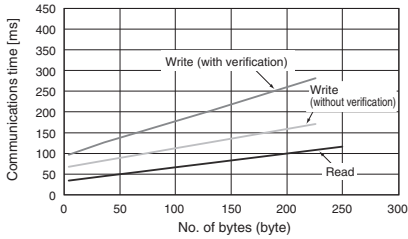

V680S-HMD6□-□□□:

V680S-D8KF6□ (M) (Communications speed setting: Normal speed)

Query	Communications time (ms) N: No. of bytes processed
Read	$T = 0.5N + 36.1$
Write (with verification)	$T = 1.0N + 93.0$
Write (without verification)	$T = 0.5N + 65.8$

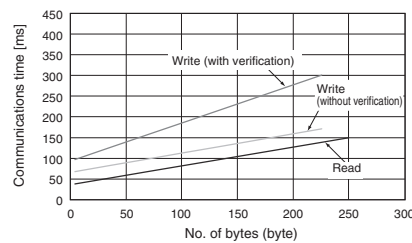

**V680 series**

**RF Tag (1K-byte memory)**

V680S-HMD6□-□□□: V680-D1KP□□T, V680-D1KP66MT, V680-D1KP66T-SP, V680-D1KP58HTN

There are no differences between Communication speed: "normal" and "high".

Query	Communications time (ms) N: No. of bytes processed
Read	$T = 1.0N + 20.1$
Write (with verification)	$T = 1.8N + 45.2$
Write (without verification)	$T = 1.5N + 41.4$

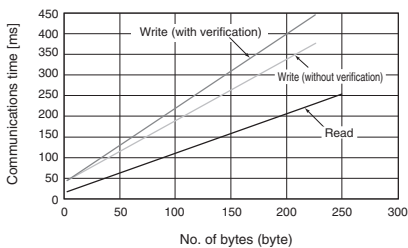

**Travel Speed Calculations**

When communicating with a moving RF Tag, specify a Repeat mode for EtherNet/IP and PROFINET or an AUTO mode for Modbus TCP. The maximum speed for communicating with the RF Tag can be calculated simply using the following formula.

$$\text{Maximum speed} = \frac{D \text{ (Distance travelled in Interrogation zone)}}{T \text{ (Communications time)}}$$

D (Distance travelled in Interrogation zone) is calculated from the actual measurement or the Interrogation zone between the Reader/Writer and RF Tag.

In order to ensure a margin, it is preferable that the communication time is calculated at twice.

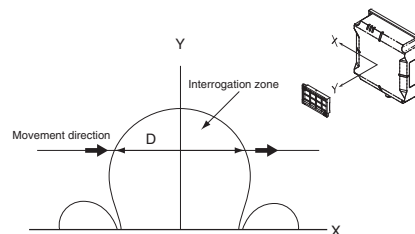

**Calculation Example**

The following example is for reading 128 bytes with the V680S-D2KF68, and V680S-HMD66-ETN.

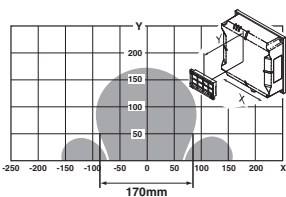

From the left chart,  
 Distance travelled in Interrogation zone = 170 mm when Y (communications distance) is 50 mm  
 Communications time  $T = 267.8$  ms (calculated from the communications time, i.e., 2 times  $\times (0.9 \times 128 \text{ bytes} + 18.7)$   
 Therefore, the maximum speed of the Tag is as follows:

$$\text{Maximum speed} = \frac{D \text{ (Distance travelled in Interrogation zone)}}{T \text{ (Communications time)}} = \frac{170 \text{ (mm)}}{267.8 \text{ (ms)}} = 38.1 \text{ m/min}$$

## Dimensions

### Reader/Writer

EtherNet/IP, PROFINET

V680S-HMD63-EIP  
V680S-HMD63-PNT

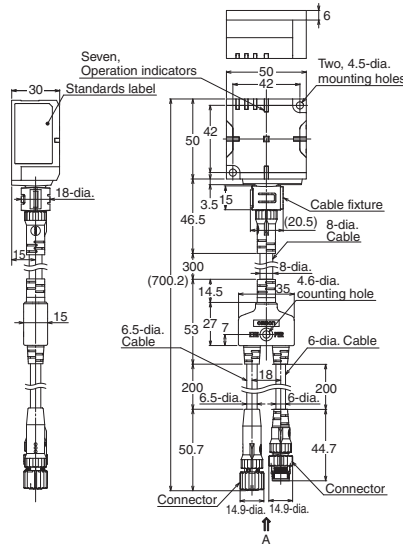

#### Mounting Hole Dimensions

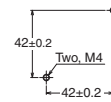

V680S-HMD64-EIP  
V680S-HMD64-PNT

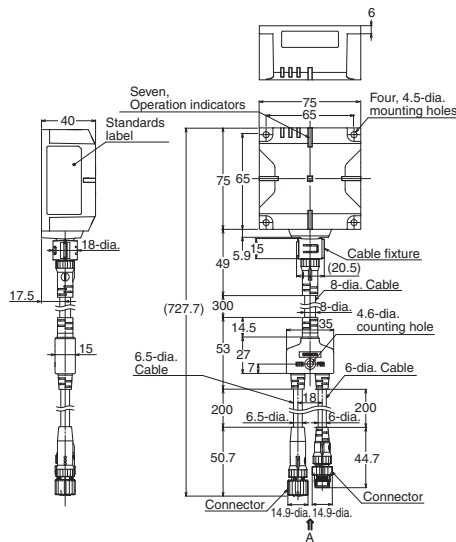

#### Mounting Hole Dimensions

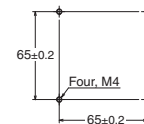

V680S-HMD66-EIP  
V680S-HMD66-PNT

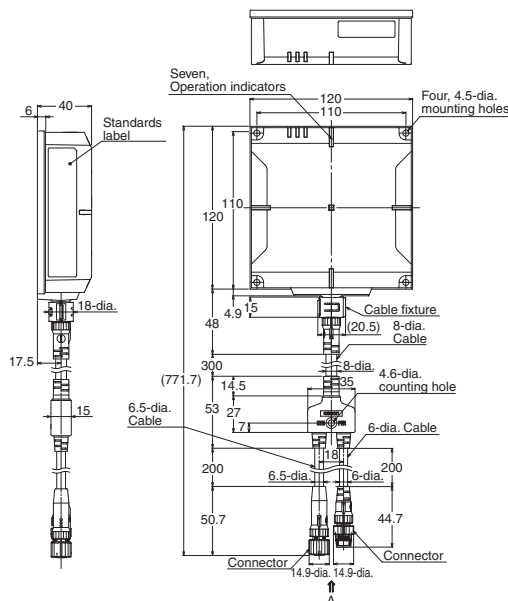

#### Mounting Hole Dimensions

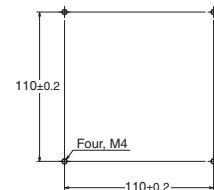



## Modbus TCP

(Unit: mm)  
Tolerance class IT16 applies to dimensions in this datasheet unless otherwise specified.

### V680S-HMD63-ETN

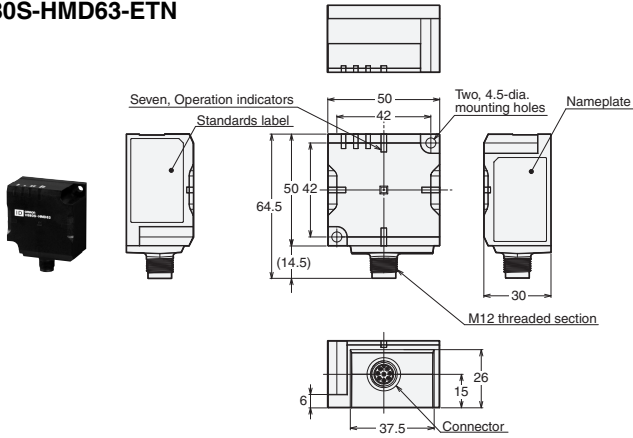

#### Mounting Hole Dimensions

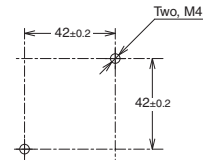

### V680S-HMD64-ETN

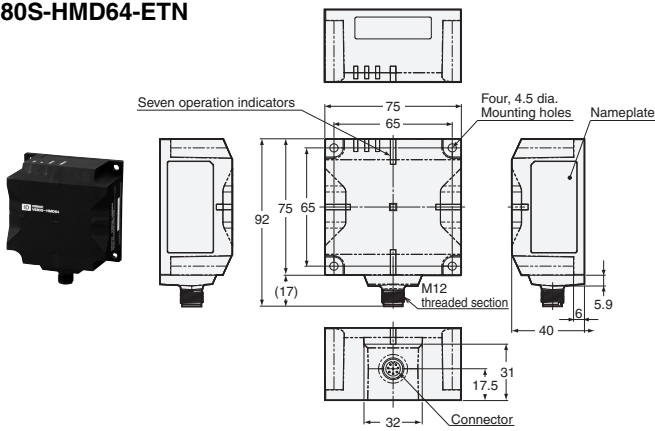

#### Mounting Hole Dimensions

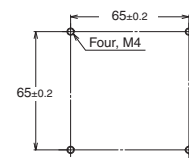

### V680S-HMD66-ETN

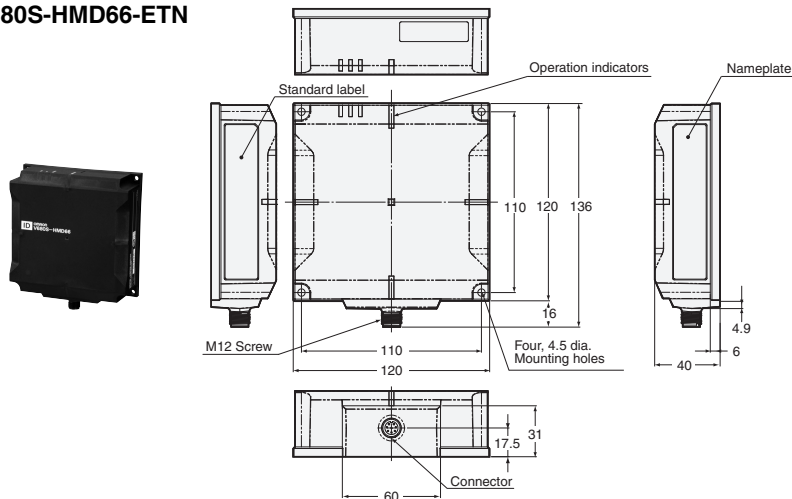

#### Mounting Hole Dimensions

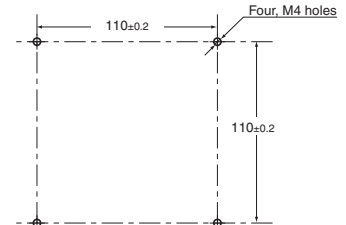

## RF Tag

(Unit: mm)  
Tolerance class IT16 applies to dimensions in this datasheet unless otherwise specified.

### V680S-D2KF67/-D2KF67M V680S-D8KF67/-D8KF67M

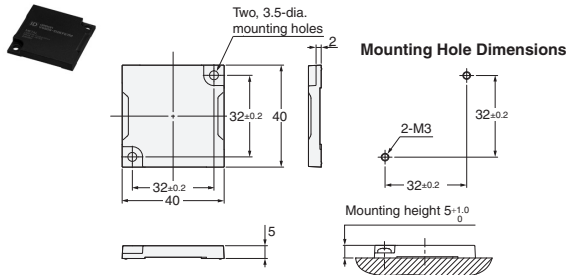

Case material | PPS resin

### V680S-D2KF68/-D2KF68M V680S-D8KF68/-D8KF68M

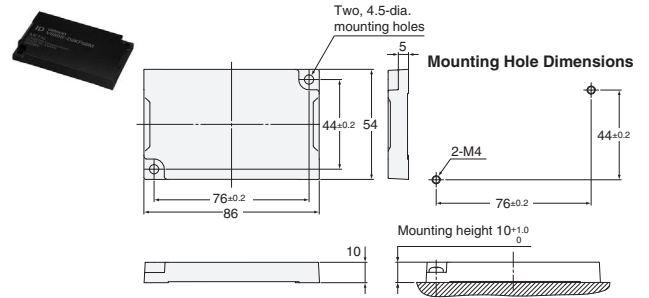

Case material | PPS resin

### V680-D1KP54T

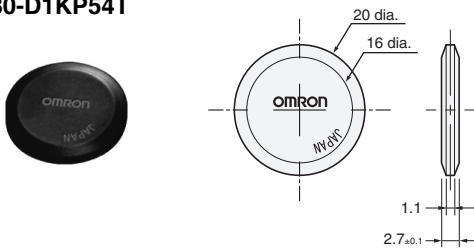

Case material | PPS resin

### V680-D1KP66T/-D1KP66MT

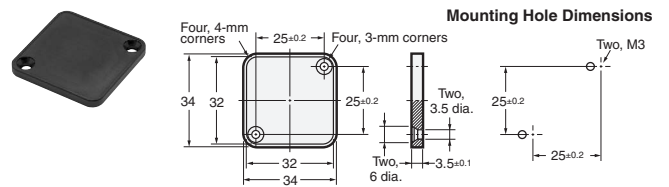

Case material | PPS resin

### V680-D1KP66T-SP

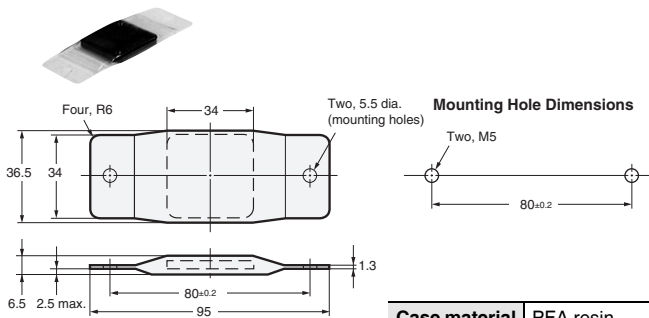

Case material | PFA resin

### V680-D1KP58HTN

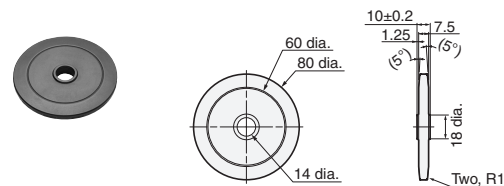

Case material | PPS resin

## RF Tag Attachment

### V680-D1KP66T Attachment V600-A86

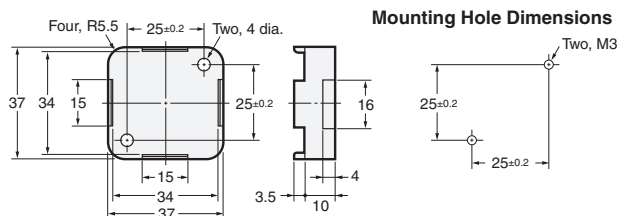

Material | PPS resin

### V680-D1KP58HTN Attachment V680-A80

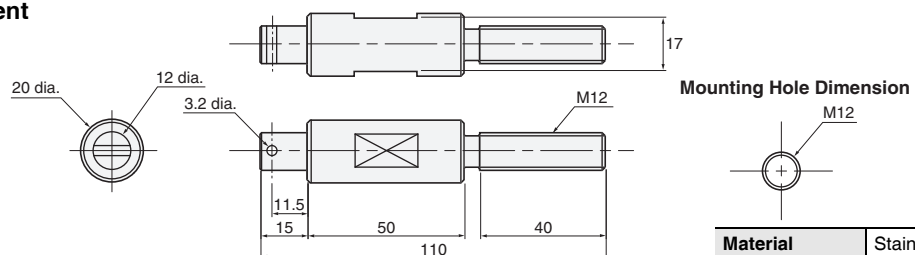

Material | Stainless steel

V680-D1KP54T Attachment  
V700-A80

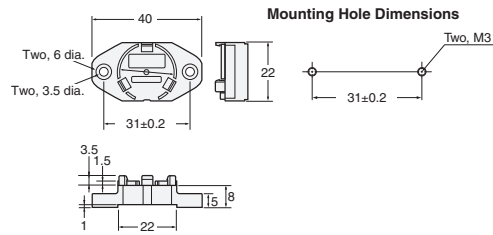

<b>Material</b>	PPS resin
-----------------	-----------

Connector Cover

V680S-A63

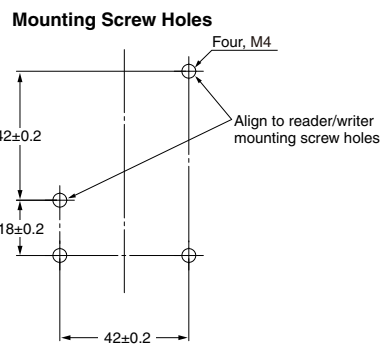
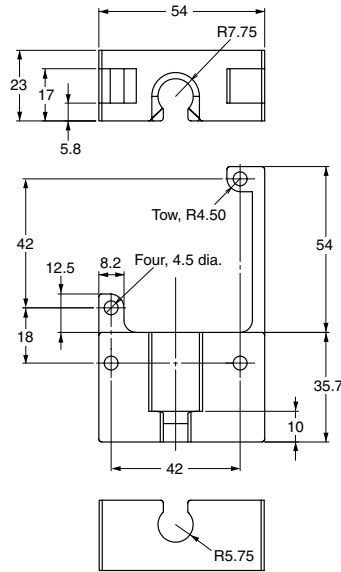
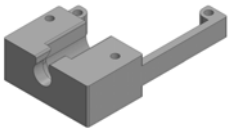

V680S-A64

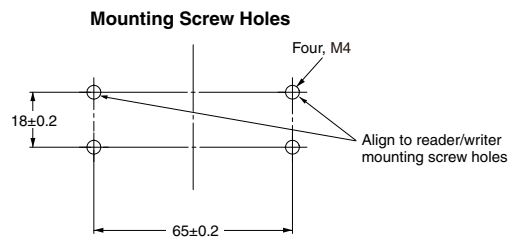
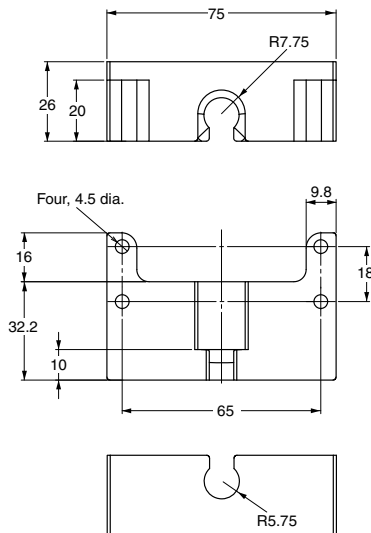
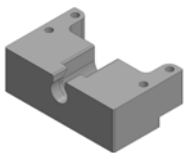

V680S-A66

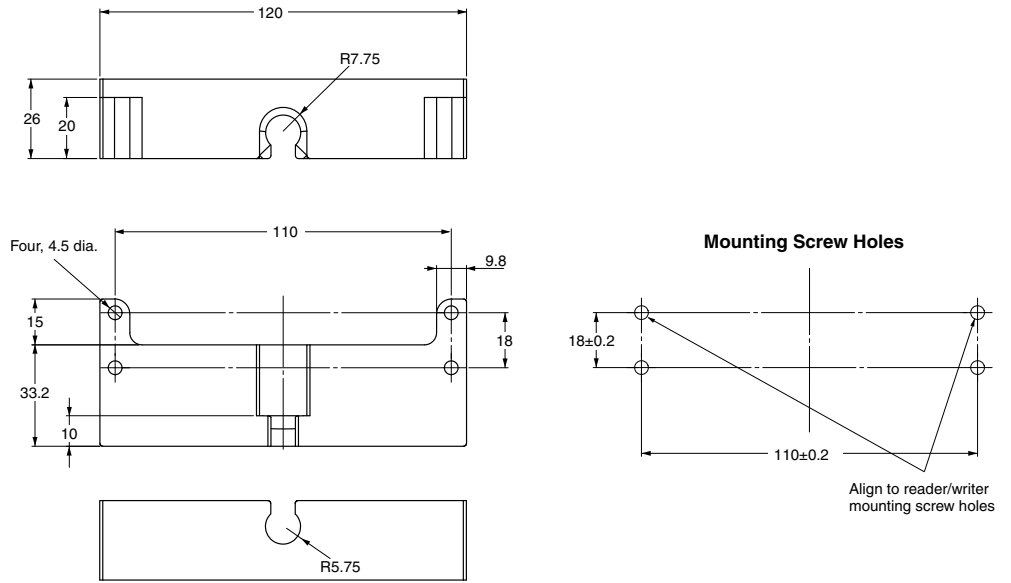
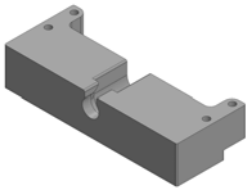

V680S-A63-S

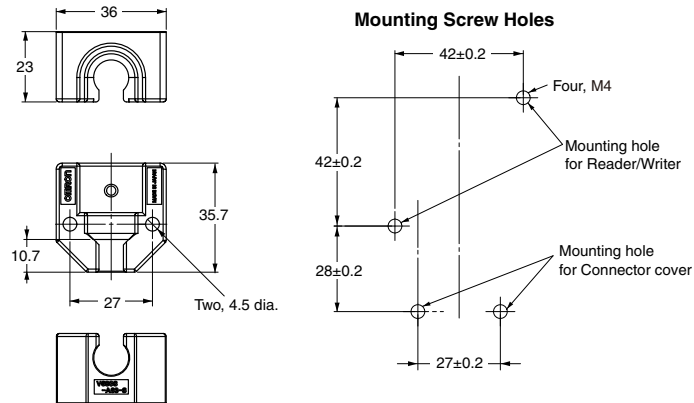

V680S-A64-S

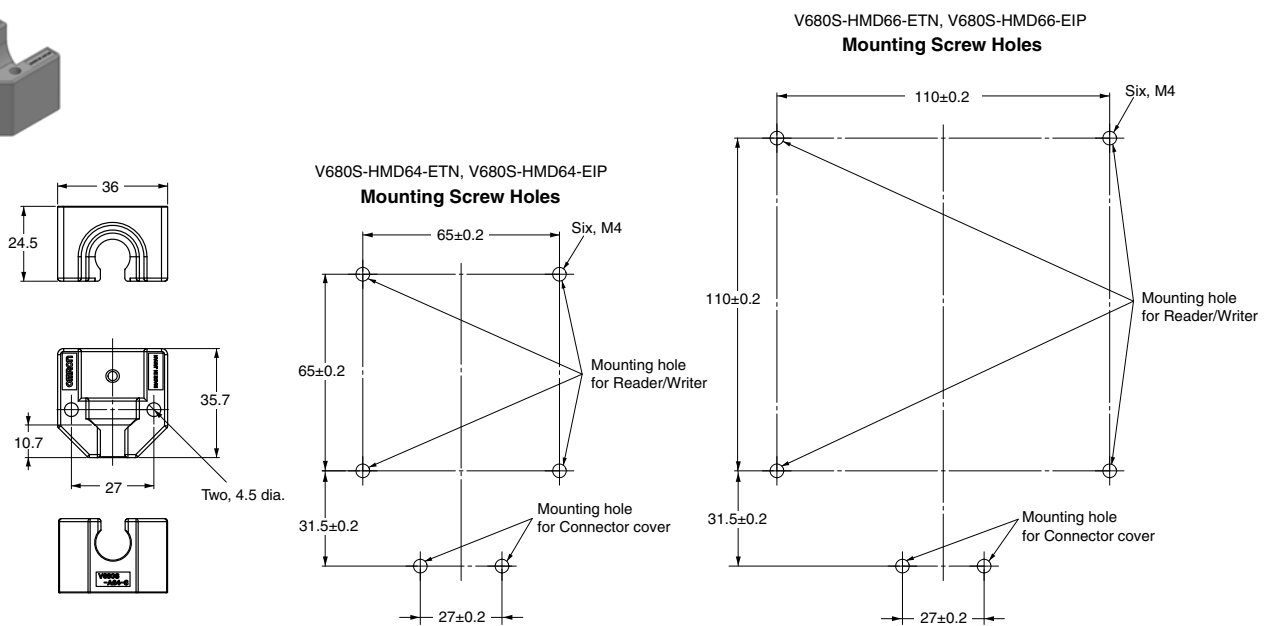

Cable for Modbus TCP

V680S-A41 □M/V680S-A51 □M \*  
Special connector – RJ45

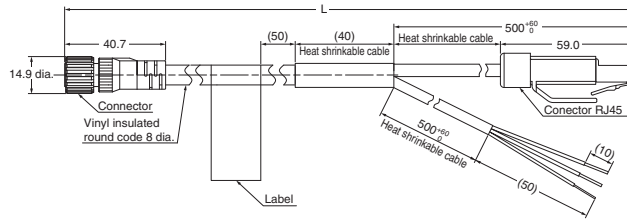

Model	L Length
V680S-A41 2M	2000 <sup>+150</sup> <sub>0</sub>
V680S-A51 2M	
V680S-A41 5M	5000 <sup>+300</sup> <sub>0</sub>
V680S-A51 5M	
V680S-A41 10M	10000 <sup>+1000</sup> <sub>0</sub>
V680S-A51 10M	

\* V680S-A51 □M is Flexible cables. Cable color is black.

V680S-A42 □M  
Special connector – Loose wires

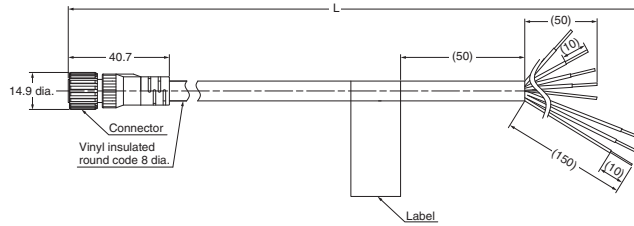

Model	L Length
V680S-A42 2M	2000 <sup>+150</sup> <sub>0</sub>
V680S-A42 5M	5000 <sup>+300</sup> <sub>0</sub>
V680S-A42 10M	10000 <sup>+1000</sup> <sub>0</sub>

Extension Cable for Modbus TCP

V680S-A40 □M/V680S-A50 □M \*  
Special connector – Special connector

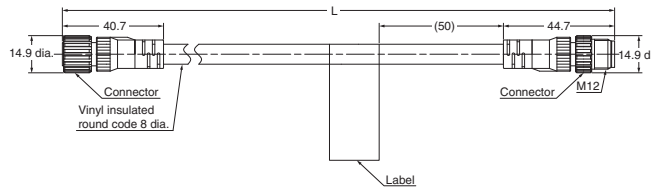

Model	L Length
V680S-A50 2M	2000 <sup>+150</sup> <sub>0</sub>
V680S-A40 10M	10000 <sup>+1000</sup> <sub>0</sub>
V680S-A50 10M	
V680S-A40 20M	20000 <sup>+2000</sup> <sub>0</sub>
V680S-A50 20M	
V680S-A40 50M	50000 <sup>+5000</sup> <sub>0</sub>

\* V680S-A51 □M is Flexible cables. Cable color is black.

## Recommended Ethernet Cable for EtherNet/IP and PROFINET

### Cable with Plugs on Both Ends (M12 Straight/RJ45) XS5W-T421-□MC-K

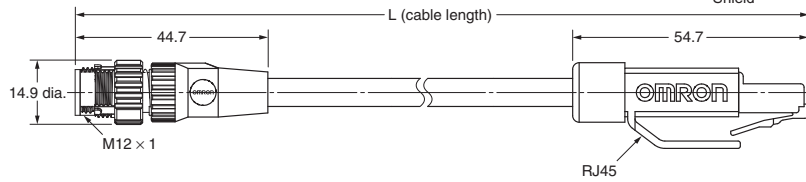

#### Wiring

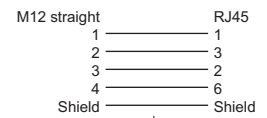

### Cable with Plugs on Both Ends (M12 Right-angle/RJ45) XS5W-T422-□MC-K

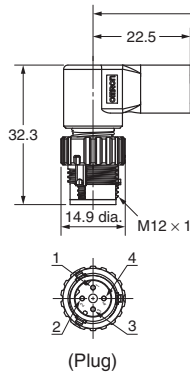

#### Wiring

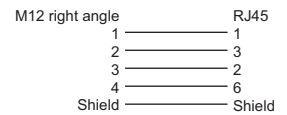

**Note:** For details, refer to the Industrial Ethernet Connectors Catalog (Cat.No.G019).

## Recommended Power Cable for EtherNet/IP and PROFINET

### XS5F-D42□-□80-□

#### Straight

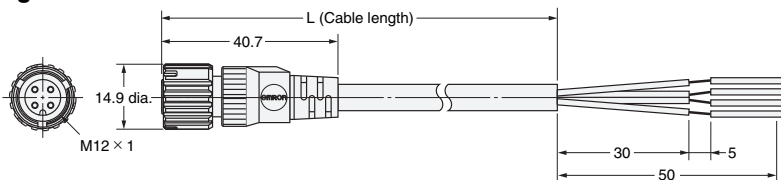

#### Angled

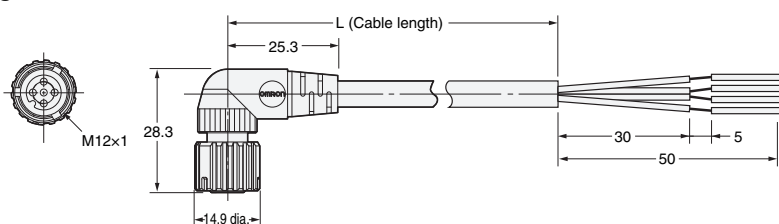

**Note:** 1. Fire-retardant, Robot cable (XS5F-D42□-□80-F) have warm gray covers.  
2. For details, refer to the Industrial Connectors Catalog (Cat. No. X082).

#### Wiring Diagram for 4 Cores

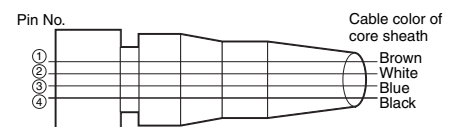

## Related Manuals

English Cat. No.	Japanese Cat. No.	Model	Name
Z339	SDGR-709	V680S-HMD6□-ETN	RFID system V680S Series User's Manual (Modbus TCP)
Z353	SDGR-710	V680S-HMD6□-EIP	RFID system V680S Series User's Manual (EtherNet/IP)
Z354	SDGR-711	V680S-HMD6□-PNT	RFID system V680S Series User's Manual (PROFINET)

## Caution for Radio Regulations

As soon as the V680S Series has been certified to comply with Radio Regulations of each country, the product label will be subject to change to include a certificate number without any advance notice. For update on compliance with Radio Regulations, refer to "Models with Standards Certification" on the OMRON website (<http://www.ia.omron.com/>)

## **Terms and Conditions Agreement**

### **Read and understand this catalog.**

Please read and understand this catalog before purchasing the products. Please consult your OMRON representative if you have any questions or comments.

### **Warranties.**

(a) Exclusive Warranty. Omron's exclusive warranty is that the Products will be free from defects in materials and workmanship for a period of twelve months from the date of sale by Omron (or such other period expressed in writing by Omron). Omron disclaims all other warranties, express or implied.

(b) Limitations. OMRON MAKES NO WARRANTY OR REPRESENTATION, EXPRESS OR IMPLIED, ABOUT NON-INFRINGEMENT, MERCHANTABILITY OR FITNESS FOR A PARTICULAR PURPOSE OF THE PRODUCTS. BUYER ACKNOWLEDGES THAT IT ALONE HAS DETERMINED THAT THE PRODUCTS WILL SUITABLY MEET THE REQUIREMENTS OF THEIR INTENDED USE.

Omron further disclaims all warranties and responsibility of any type for claims or expenses based on infringement by the Products or otherwise of any intellectual property right. (c) Buyer Remedy. Omron's sole obligation hereunder shall be, at Omron's election, to (i) replace (in the form originally shipped with Buyer responsible for labor charges for removal or replacement thereof) the non-complying Product, (ii) repair the non-complying Product, or (iii) repay or credit Buyer an amount equal to the purchase price of the non-complying Product; provided that in no event shall Omron be responsible for warranty, repair, indemnity or any other claims or expenses regarding the Products unless Omron's analysis confirms that the Products were properly handled, stored, installed and maintained and not subject to contamination, abuse, misuse or inappropriate modification. Return of any Products by Buyer must be approved in writing by Omron before shipment. Omron Companies shall not be liable for the suitability or unsuitability or the results from the use of Products in combination with any electrical or electronic components, circuits, system assemblies or any other materials or substances or environments. Any advice, recommendations or information given orally or in writing, are not to be construed as an amendment or addition to the above warranty.

See <http://www.omron.com/global/> or contact your Omron representative for published information.

### **Limitation on Liability; Etc.**

OMRON COMPANIES SHALL NOT BE LIABLE FOR SPECIAL, INDIRECT, INCIDENTAL, OR CONSEQUENTIAL DAMAGES, LOSS OF PROFITS OR PRODUCTION OR COMMERCIAL LOSS IN ANY WAY CONNECTED WITH THE PRODUCTS, WHETHER SUCH CLAIM IS BASED IN CONTRACT, WARRANTY, NEGLIGENCE OR STRICT LIABILITY.

Further, in no event shall liability of Omron Companies exceed the individual price of the Product on which liability is asserted.

### **Suitability of Use.**

Omron Companies shall not be responsible for conformity with any standards, codes or regulations which apply to the combination of the Product in the Buyer's application or use of the Product. At Buyer's request, Omron will provide applicable third party certification documents identifying ratings and limitations of use which apply to the Product. This information by itself is not sufficient for a complete determination of the suitability of the Product in combination with the end product, machine, system, or other application or use. Buyer shall be solely responsible for determining appropriateness of the particular Product with respect to Buyer's application, product or system. Buyer shall take application responsibility in all cases.

NEVER USE THE PRODUCT FOR AN APPLICATION INVOLVING SERIOUS RISK TO LIFE OR PROPERTY OR IN LARGE QUANTITIES WITHOUT ENSURING THAT THE SYSTEM AS A WHOLE HAS BEEN DESIGNED TO ADDRESS THE RISKS, AND THAT THE OMRON PRODUCT(S) IS PROPERLY RATED AND INSTALLED FOR THE INTENDED USE WITHIN THE OVERALL EQUIPMENT OR SYSTEM.

### **Programmable Products.**

Omron Companies shall not be responsible for the user's programming of a programmable Product, or any consequence thereof.

### **Performance Data.**

Data presented in Omron Company websites, catalogs and other materials is provided as a guide for the user in determining suitability and does not constitute a warranty. It may represent the result of Omron's test conditions, and the user must correlate it to actual application requirements. Actual performance is subject to the Omron's Warranty and Limitations of Liability.

### **Change in Specifications.**

Product specifications and accessories may be changed at any time based on improvements and other reasons. It is our practice to change part numbers when published ratings or features are changed, or when significant construction changes are made. However, some specifications of the Product may be changed without any notice. When in doubt, special part numbers may be assigned to fix or establish key specifications for your application. Please consult with your Omron's representative at any time to confirm actual specifications of purchased Product.

### **Errors and Omissions.**

Information presented by Omron Companies has been checked and is believed to be accurate; however, no responsibility is assumed for clerical, typographical or proofreading errors or omissions.

Note. Do not use this document to operate the Unit.

**OMRON Corporation** Industrial Automation Company  
Tokyo, JAPAN

Contact: [www.ia.omron.com](http://www.ia.omron.com)

**Regional Headquarters**

**OMRON EUROPE B.V.**

Wegalaan 67-69-2132 JD Hoofddorp  
The Netherlands

Tel: (31)2356-81-300/Fax: (31)2356-81-388

**OMRON ELECTRONICS LLC**

One Commerce Drive Schaumburg,  
IL 60173-5302 U.S.A.

Tel: (1) 847-843-7900/Fax: (1) 847-843-7787

**OMRON ASIA PACIFIC PTE. LTD.**

No. 438A Alexandra Road # 05-05/08 (Lobby 2),  
Alexandra Technopark,  
Singapore 119967

Tel: (65) 6835-3011/Fax: (65) 6835-2711

**OMRON (CHINA) CO., LTD.**

Room 2211, Bank of China Tower,  
200 Yin Cheng Zhong Road,  
PuDong New Area, Shanghai, 200120, China

Tel: (86) 21-5037-2222/Fax: (86) 21-5037-2200

Authorized Distributor:

© OMRON Corporation 2013-2021 All Rights Reserved.  
In the interest of product improvement,  
specifications are subject to change without notice.

**CSM\_8\_5**

**Cat. No. Q196-E1-07**

0721(0413)