

FX8/FX8C Series

High Speed Transmission, 0.6mm Pitch Mezzanine Connectors

FunctionMAX™

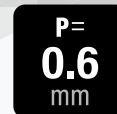

P= 0.6mm



High-Speed



Wide Variation



Sep. 1.2024 Copyright 2024 HIROSE ELECTRIC CO., LTD. All Rights Reserved.



Features

1. Pitch : 0.6mm

2. Wide Variety of No. of Pos. and Stacking Heights

Connection Type: Stacking
 No. of Pos.: Signal Terminals
 (60, 80, 100, 120, 140 pos.)
 Stacking height:
 3, 4, 5, 6, 7, 8, 9, 10, 11, 12, 14, 16mm

3. Mating Inducement

Inducement rib enhances engagement operability, providing self-alignment of ± 0.6 mm.

4. High-speed Transmission (8Gbps)

Supports PCI-e Gen. 3 with a 16mm height. For compatibility with other transmission standards, please contact our sales representatives.

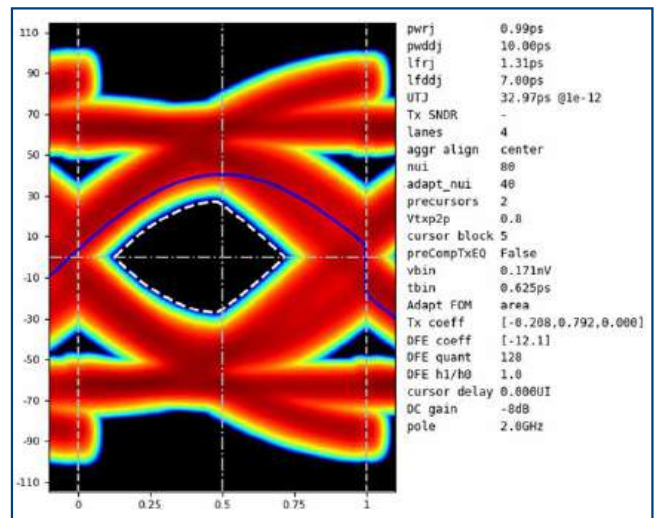

5. Prevents Incorrect Insertion into the Board

Features a positioning boss for the PCB. The boss's position and diameter help prevent incorrect insertion.

6. Compliant with RoHS (EU) 2015/863

This product complies with the RoHS Directive and does not contain prohibited substances, reflecting our commitment to environmental responsibility.

Application

Ideal for internal connections in devices like notebook PCs, measuring instruments, PPCs, MFPs, industrial equipment, and medical equipment where miniaturization and weight reduction are essential.

Product Specifications

Rated Current	0.4A	Operating Temperature (Note 1)(Note 2)	-55 to +85°C
		Storage Temperature Range	-10 to +60°C
Rated Voltage	100V AC	Operating Humidity Range	85% or less relative humidity (No dew condensation)
		Storage Humidity Range	

Items	Specifications (FX8)	Specifications (FX8C)	Conditions
Contact Resistance	45m Ω Max.	80m Ω Max.	Measured at 100mA
Insulation Resistance	1000M Ω Min.	100M Ω Min.	Measured at 250V DC
Withstanding Voltage	No Flashover or Breakdown.	No Flashover or Breakdown.	300V AC for 1 min.
Mating Durability	Contact Resistance : 55m Ω Max.	Contact Resistance : 100m Ω Max.	50 times
Vibration Proof	No electrical discontinuity of 1 μs or more	No electrical discontinuity of 1 μs or more	Frequency 10-55Hz, half amplitude 0.75mm, 10 cycles in each of the 3-axis directions each for 5 minutes per cycle
Shock Resistance	No electrical discontinuity of 1 μs or more	No electrical discontinuity of 1 μs or more	Acceleration of 490m/s ² , duration 11ms, sine half-wave, 3 cycles in each of the 3 axes directions.
Moisture Resistance	Contact Resistance : 55m Ω Max. Insulation Resistance : 100M Ω Min.	Contact Resistance : 100m Ω Max. Insulation Resistance : 100M Ω以上	Left to stand for 96 hours at a temperature of +40 ± 2°C and a humidity of 90 to 95%
Temperature Cycle	Contact Resistance : 55m Ω Max. Insulation Resistance : 100M Ω Min.	Contact Resistance : 100m Ω Max. Insulation Resistance : 100M Ω Min.	Temperature -55°C → +85°C 5 cycles for a series of time periods : 30 minutes → 30 minutes

Note 1 : Includes temperature rise due to current flow.

Note 2 : The term "storage" refers to the long-term storage condition of unused products before mounting on PCB.

Materials / Finish

Part	Materials	Finish	Remarks
Insulator	PPS Resin	Light Brown	UL94V-0
Header Contact	Phosphor Bronze	Contacted Part : Gold Plating Lead Part : Pure Tin Plating (Note 2)	-
Receptacle Contact		Contacted Part : Gold Plating Lead Part : Pure Tin Plating (Note 2)	-

Note 1 : Black spots may appear on the insulating resin. Due to the nature of the material, the color may change when exposed to sunlight or fluorescent lamps. However, this does not affect the quality of the product.

Note 2 : FX8-##P-SV, FX8C-##P-SV, FX8C-##S-SV are Gold Plating

Product Number Structure

Refer to the chart below when determining the product specifications from the product number.
Please select from the product numbers listed in this catalog when placing orders.

FX8 Straight Header

FX8 - 140 P - SV 1 (##)

① ② ③ ④ ⑤ ⑥

① Series Name	FX8	④ Product Type	SV : Straight Type
② No. of Pos.	60, 80, 100, 120, 140	⑤ Product Height Type	None : Standard (Lowest Profile) 1 : +1mm
③ Connector Type	P : Header Type	⑥ Packaging Specifications	(71) : Tray Packaging (92) : Embossed Packaging

FX8 Straight Receptacle

FX8 - 140 S - SV (##)

① ② ③ ④ ⑤

① Series Name	FX8	④ Product Type	SV : Straight Type
② No. of Pos.	60, 80, 100, 120, 140	⑤ Packaging Specifications	None : Tray Packaging (22) : Embossed Packaging
③ Connector Type	S : Receptacle Type		

FX8C Straight Header

FX8 - 140 P - SV 1 (##)

① ② ③ ④ ⑤ ⑥

① Series Name	FX8C	④ Product Type	SV : Straight Type
② No. of Pos.	60, 80, 100, 120, 140	⑤ Product Height Type	None : Standard (Lowest Profile) 1, 2, 4, 6 : +1mm · · · · +6mm
③ Connector Type	P : Header Type	⑥ Packaging Specifications	(71) : Tray Packaging (92) : Embossed Packaging

FX8C Straight Receptacle















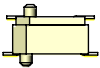

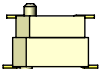
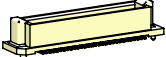
FX8C - 140 S - SV 1 (##)

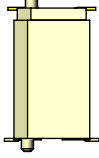
① ② ③ ④ ⑤ ⑥

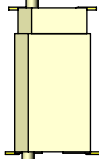
① Series Name	FX8C	④ Product Type	SV : Straight Type
② No. of Pos.	60, 80, 100, 120, 140	⑤ Product Height Type	None : Standard (Lowest Profile) 5 : +5mm
③ Connector Type	S : Receptacle Type	⑥ Packaging Specifications	(71) : Tray Packaging (92) : Embossed Packaging

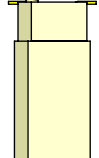
Sep. 1. 2024 Copyright 2024 HIROSE ELECTRIC CO., LTD. All Rights Reserved.

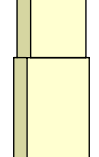
Connection Variation

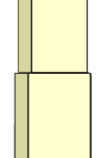
	 FX8-##S-SV	 FX8C-##S-SV	 FX8C-##S-SV5
 FX8-##P-SV	 3mm	—	—
 FX8-##P-SV1	 4mm	—	—
 FX8C-##P-SV	—	 5mm	 10mm
 FX8C-##P-SV1	—	 6mm	 11mm
 FX8C-##P-SV2	—	 7mm	 12mm
 FX8C-##P-SV4	—	 9mm	 14mm
 FX8C-##P-SV6	—	 11mm	 16mm

Note : Please note that the FX8 and FX8C cannot be combined.

FX8 Straight Header (Standard Product Height)

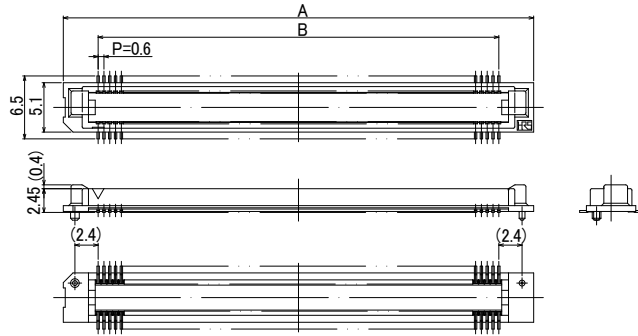

● Recommended Land Pattern and Metal Mask Dimensions (Mounting Surface)

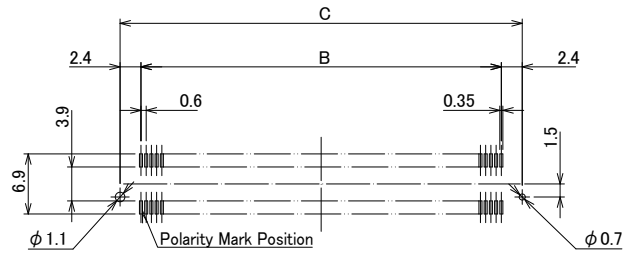

Recommended Metal Mask Thickness : 0.15mm

Unit : mm

Part No.	HRS No.	No. of Pos.	A	B	C	Purchase Unit (##) : (71)	Purchase Unit (##) : (92)
FX8-60P-SV(##)	CL0578-0001-6-##	60	24.6	17.4	22.2	216pcs per tray	1,000pcs per reel
FX8-80P-SV(##)	CL0578-0003-1-##	80	30.6	23.4	28.2	168pcs per tray	
FX8-100P-SV(##)	CL0578-0005-7-##	100	36.6	29.4	34.2	144pcs per tray	
FX8-120P-SV(##)	CL0578-0006-0-##	120	42.6	35.4	40.2	120pcs per tray	
FX8-140P-SV(##)	CL0578-0007-2-##	140	48.6	41.4	46.2	96pcs per tray	

Note : Tray package is not compatible with automatic mounting.

FX8 Straight Header (Product Height Standard +1 mm Product)

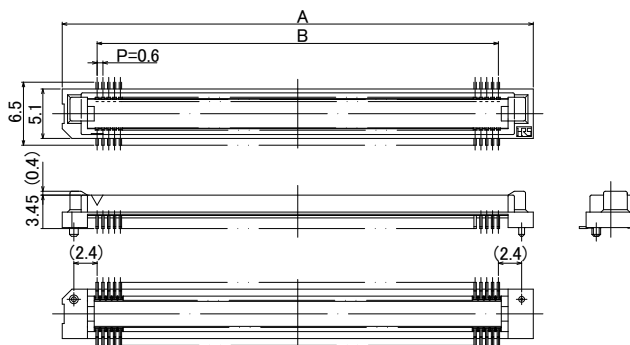

● Recommended Land Pattern and Metal Mask Dimensions (Mounting Surface)

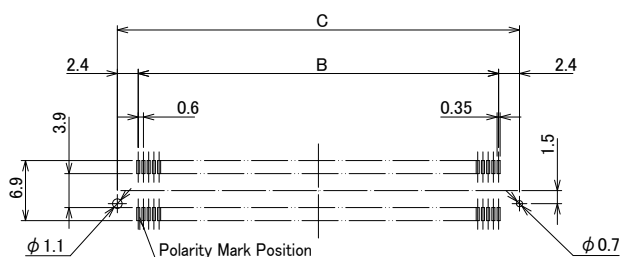

Recommended Metal Mask Thickness : 0.15mm

Unit : mm

Part No.	HRS No.	No. of Pos.	A	B	C	Purchase Unit (##) : (71)	Purchase Unit (##) : (92)
FX8-60P-SV1(##)	CL0578-0041-0-##	60	24.6	17.4	22.2	216pcs per tray	1,000pcs per reel
FX8-80P-SV1(##)	CL0578-0043-6-##	80	30.6	23.4	28.2	168pcs per tray	
FX8-100P-SV1(##)	CL0578-0045-1-##	100	36.6	29.4	34.2	144pcs per tray	
FX8-120P-SV1(##)	CL0578-0046-4-##	120	42.6	35.4	40.2	120pcs per tray	
FX8-140P-SV1(##)	CL0578-0047-7-##	140	48.6	41.4	46.2	96pcs per tray	

Note : Tray package is not compatible with automatic mounting.

FX8 Straight Receptacle

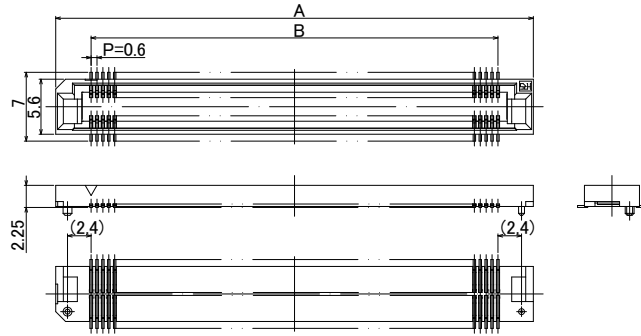

● Recommended Land Pattern and Metal Mask Dimensions (Mounting Surface)

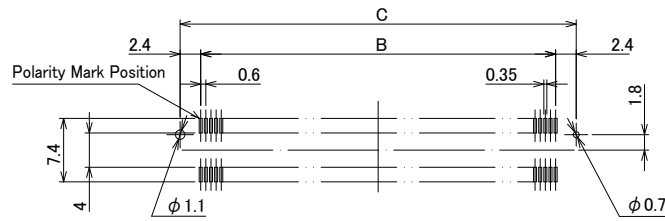

Recommended Metal Mask Thickness : 0.15mm

Unit : mm

Part No.	HRS No.	No. of Pos.	A	B	C	Purchase Unit (##) : (00)	Purchase Unit (##) : (22)
FX8-60S-SV(##)	CL0578-0201-5-##	60	24.6	17.4	22.2	216pcs per tray	1,000pcs per reel
FX8-80S-SV(##)	CL0578-0203-0-##	80	30.6	23.4	28.2	168pcs per tray	
FX8-100S-SV(##)	CL0578-0205-6-##	100	36.6	29.4	34.2	144pcs per tray	
FX8-120S-SV(##)	CL0578-0206-9-##	120	42.6	35.4	40.2	120pcs per tray	
FX8-140S-SV(##)	CL0578-0207-1-##	140	48.6	41.4	46.2	96pcs per tray	

Note : Tray package is not compatible with automatic mounting.

FX8C Straight Header (Standard Product Height)

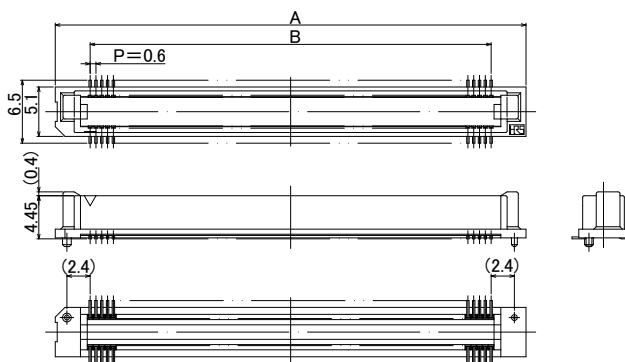

● Recommended Land Pattern and Metal Mask Dimensions (Mounting Surface)

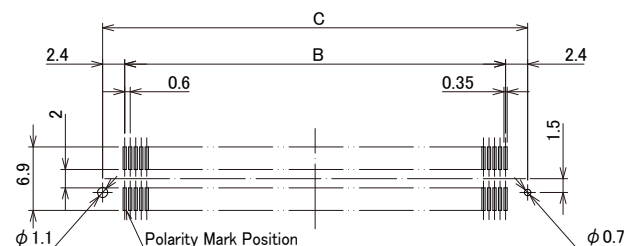

Recommended Metal Mask Thickness : 0.15mm

Unit : mm

Part No.	HRS No.	No. of Pos.	A	B	C	Purchase Unit (##) : (71)	Purchase Unit (##) : (92)
FX8C-60P-SV(##)	CL0578-0501-9-##	60	24.6	17.4	22.2	162pcs per tray	1,000pcs per reel
FX8C-80P-SV(##)	CL0578-0503-4-##	80	30.6	23.4	28.2	126pcs per tray	
FX8C-100P-SV(##)	CL0578-0505-0-##	100	36.6	29.4	34.2	108pcs per tray	
FX8C-120P-SV(##)	CL0578-0506-2-##	120	42.6	35.4	40.2	90pcs per tray	
FX8C-140P-SV(##)	CL0578-0507-5-##	140	48.6	41.4	46.2	72pcs per tray	

Note : Tray package is not compatible with automatic mounting.

FX8C Straight Header (Standard Product Height +1mm Product)

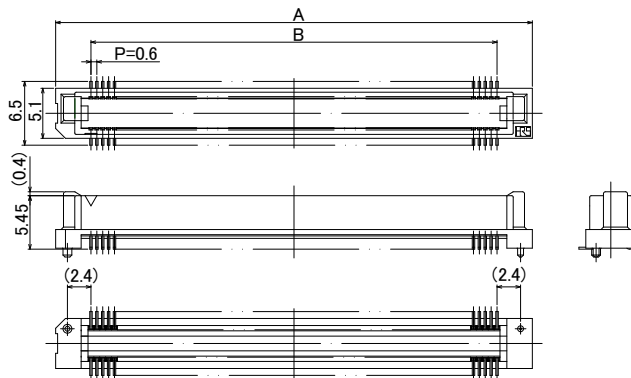

● Recommended Land Pattern and Metal Mask Dimensions (Mounting Surface)

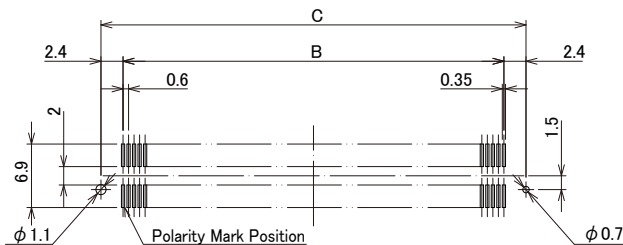

Recommended Metal Mask Thickness : 0.15mm

Unit : mm

Part No.	HRS No.	No. of Pos.	A	B	C	Purchase Unit (##) : (71)	Purchase Unit (##) : (92)
FX8C-60P-SV1(##)	CL0578-0521-6-##	60	24.6	17.4	22.2	162pcs per tray	1,000pcs per reel
FX8C-80P-SV1(##)	CL0578-0523-1-##	80	30.6	23.4	28.2	126pcs per tray	
FX8C-100P-SV1(##)	CL0578-0525-7-##	100	36.6	29.4	34.2	108pcs per tray	
FX8C-120P-SV1(##)	CL0578-0526-0-##	120	42.6	35.4	40.2	90pcs per tray	
FX8C-140P-SV1(##)	CL0578-0527-2-##	140	48.6	41.4	46.2	72pcs per tray	

Note : Tray package is not compatible with automatic mounting.

FX8C Straight Header (Standard Product Height +2mm Product)

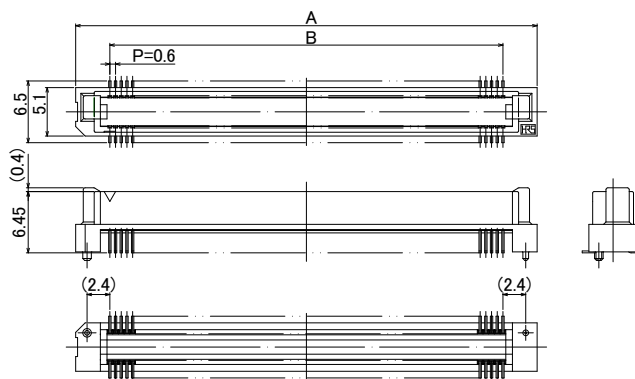

● Recommended Land Pattern and Metal Mask Dimensions (Mounting Surface)

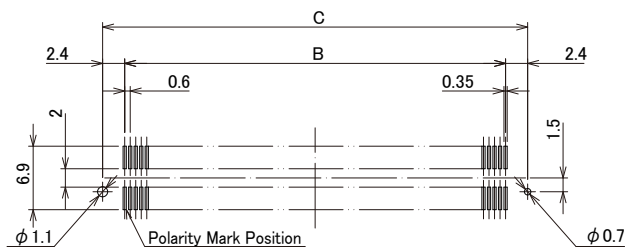

Recommended Metal Mask Thickness : 0.15mm

Unit : mm

Part No.	HRS No.	No. of Pos.	A	B	C	Purchase Unit (##) : (71)	Purchase Unit (##) : (92)
FX8C-60P-SV2(##)	CL0578-0541-3-##	60	24.6	17.4	22.2	162pcs per tray	1,000pcs per reel
FX8C-80P-SV2(##)	CL0578-0543-9-##	80	30.6	23.4	28.2	126pcs per tray	
FX8C-100P-SV2(##)	CL0578-0545-4-##	100	36.6	29.4	34.2	108pcs per tray	
FX8C-120P-SV2(##)	CL0578-0546-7-##	120	42.6	35.4	40.2	90pcs per tray	
FX8C-140P-SV2(##)	CL0578-0547-0-##	140	48.6	41.4	46.2	72pcs per tray	

Note : Tray package is not compatible with automatic mounting.

FX8C Straight Header (Standard Product Height +4mm Product)

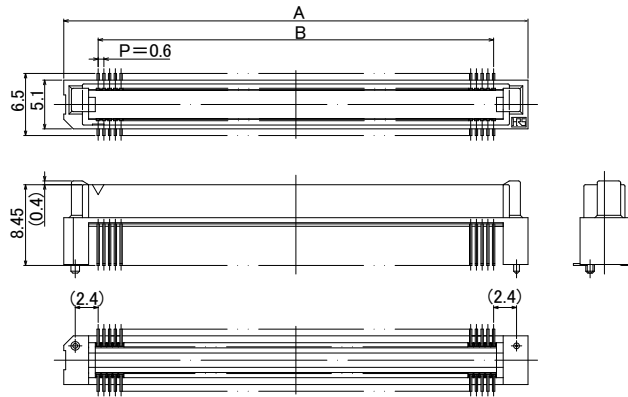

● Recommended Land Pattern and Metal Mask Dimensions (Mounting Surface)

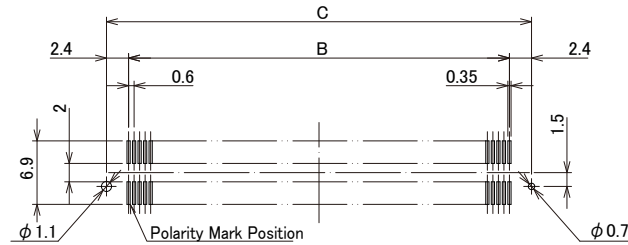

Recommended Metal Mask Thickness : 0.15mm

Unit : mm

Part No.	HRS No.	No. of Pos.	A	B	C	Purchase Unit (##) : (71)	Purchase Unit (##) : (92)
FX8C-60P-SV4(##)	CL0578-0581-8-##	60	24.6	17.4	22.2	162pcs per tray	500pcs per reel
FX8C-80P-SV4(##)	CL0578-0583-3-##	80	30.6	23.4	28.2	126pcs per tray	
FX8C-100P-SV4(##)	CL0578-0585-9-##	100	36.6	29.4	34.2	108pcs per tray	
FX8C-120P-SV4(##)	CL0578-0586-1-##	120	42.6	35.4	40.2	90pcs per tray	
FX8C-140P-SV4(##)	CL0578-0587-4-##	140	48.6	41.4	46.2	72pcs per tray	

Note : Tray package is not compatible with automatic mounting.

FX8C Straight Header (Standard Product Height +6mm Product)

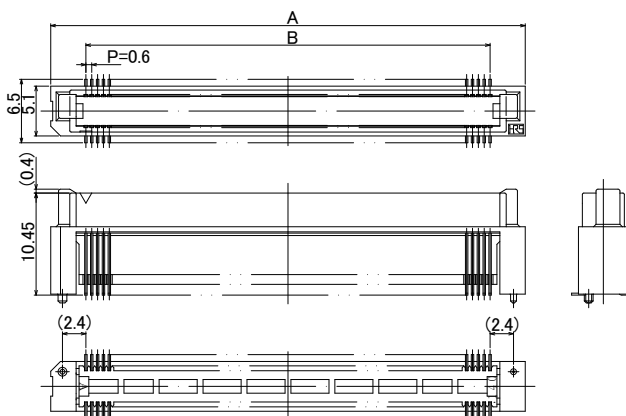

● Recommended Land Pattern and Metal Mask Dimensions (Mounting Surface)

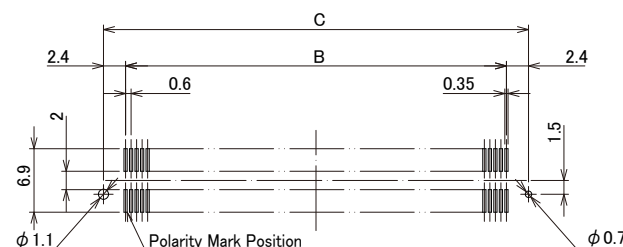

Recommended Metal Mask Thickness : 0.15mm

Unit : mm

Part No.	HRS No.	No. of Pos.	A	B	C	Purchase Unit (##) : (71)	Purchase Unit (##) : (92)
FX8C-60P-SV6(##)	CL0578-0601-3-##	60	24.6	17.4	22.2	162pcs per tray	500pcs per reel
FX8C-80P-SV6(##)	CL0578-0603-9-##	80	30.6	23.4	28.2	126pcs per tray	
FX8C-100P-SV6(##)	CL0578-0605-4-##	100	36.6	29.4	34.2	108pcs per tray	
FX8C-120P-SV6(##)	CL0578-0606-7-##	120	42.6	35.4	40.2	90pcs per tray	
FX8C-140P-SV6(##)	CL0578-0607-0-##	140	48.6	41.4	46.2	72pcs per tray	

Note : Tray package is not compatible with automatic mounting.

FX8C Straight Receptacle (Standard Product Height)

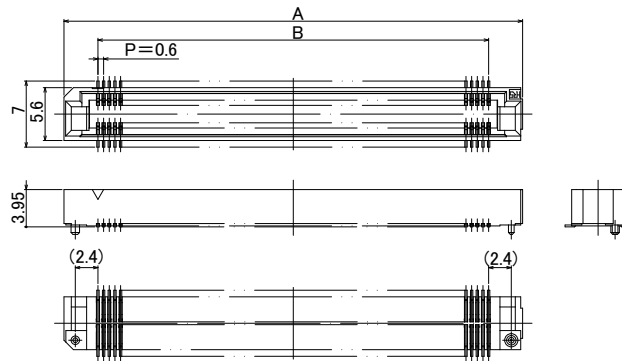

● Recommended Land Pattern and Metal Mask Dimensions (Mounting Surface)

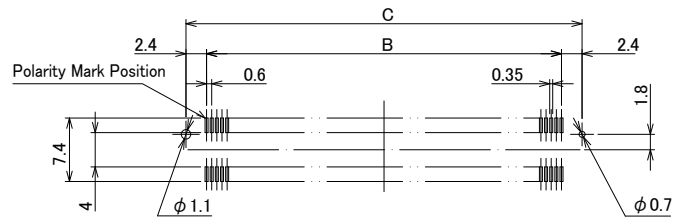

Recommended Metal Mask Thickness : 0.15mm

Unit : mm

Part No.	HRS No.	No. of Pos.	A	B	C	Purchase Unit (##) : (71)	Purchase Unit (##) : (92)
FX8C-60S-SV(##)	CL0578-0801-2-##	60	24.6	17.4	22.2	162pcs per tray	500pcs per reel
FX8C-80S-SV(##)	CL0578-0803-8-##	80	30.6	23.4	28.2	126pcs per tray	
FX8C-100S-SV(##)	CL0578-0805-3-##	100	36.6	29.4	34.2	108pcs per tray	
FX8C-120S-SV(##)	CL0578-0806-6-##	120	42.6	35.4	40.2	90pcs per tray	
FX8C-140S-SV(##)	CL0578-0807-9-##	140	48.6	41.4	46.2	72pcs per tray	

Note : Tray package is not compatible with automatic mounting.

FX8C Straight Receptacle (Product Height +5mm Product)

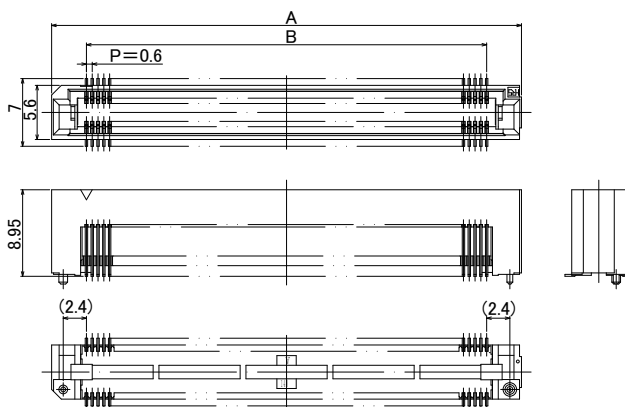

● Recommended Land Pattern and Metal Mask Dimensions (Mounting Surface)

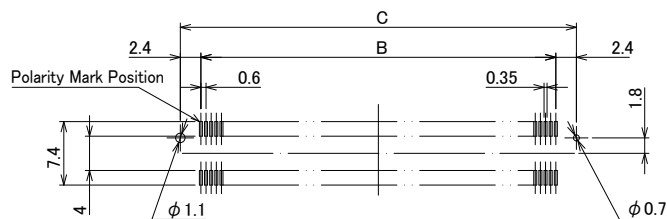

Recommended Metal Mask Thickness : 0.15mm

Unit : mm

Part No.	HRS No.	No. of Pos.	A	B	C	Purchase Unit (##) : (71)	Purchase Unit (##) : (92)
FX8C-60S-SV5(##)	CL0578-0821-0-##	60	24.6	17.4	22.2	162pcs per tray	500pcs per reel
FX8C-80S-SV5(##)	CL0578-0823-5-##	80	30.6	23.4	28.2	126pcs per tray	
FX8C-100S-SV5(##)	CL0578-0825-0-##	100	36.6	29.4	34.2	108pcs per tray	
FX8C-120S-SV5(##)	CL0578-0826-3-##	120	42.6	35.4	40.2	90pcs per tray	
FX8C-140S-SV5(##)	CL0578-0827-6-##	140	48.6	41.4	46.2	72pcs per tray	

Note : Tray package is not compatible with automatic mounting.

Packing Specifications

Tray Packing Specifications (FX8 Straight Header)

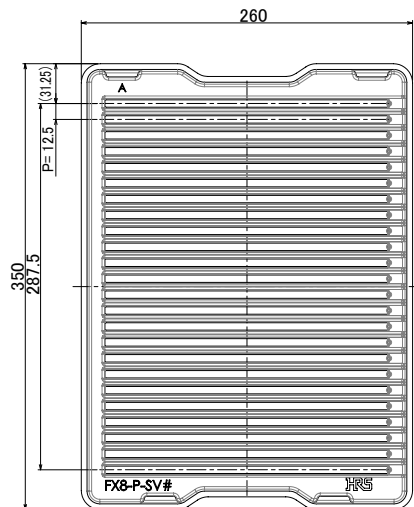

■ FX8 Straight Header (Standard Product Height)

Part No.	HRS No.	No. of Pos.
FX8-60P-SV(71)	CL0578-0001-6-71	60
FX8-80P-SV(71)	CL0578-0003-1-71	80
FX8-100P-SV(71)	CL0578-0005-7-71	100
FX8-120P-SV(71)	CL0578-0006-0-71	120
FX8-140P-SV(71)	CL0578-0007-2-71	140

■ FX8 Straight Header (Product Height Standard + 1mm Product)

Part No.	HRS No.	No. of Pos.
FX8-60P-SV1(71)	CL0578-0041-0-71	60
FX8-80P-SV1(71)	CL0578-0043-6-71	80
FX8-100P-SV1(71)	CL0578-0045-1-71	100
FX8-120P-SV1(71)	CL0578-0046-4-71	120
FX8-140P-SV1(71)	CL0578-0047-7-71	140

Tray Packing Specifications (FX8 Straight Receptacle)

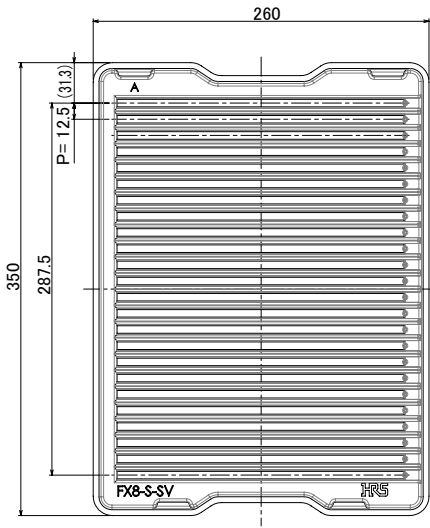

■ FX8 Straight Receptacle

Part No.	HRS No.	No. of Pos.
FX8-60S-SV	CL0578-0201-5-00	60
FX8-80S-SV	CL0578-0203-0-00	80
FX8-100S-SV	CL0578-0205-6-00	100
FX8-120S-SV	CL0578-0206-9-00	120
FX8-140S-SV	CL0578-0207-1-00	140

Tray Packing Specifications (FX8C Straight Header)

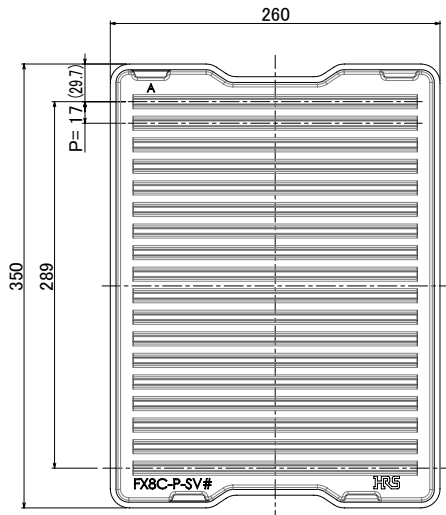

■ FX8C Straight Header (Standard Product Height)

Part No.	HRS No.	No. of Pos.
FX8C-60P-SV(71)	CL0578-0501-9-71	60
FX8C-80P-SV(71)	CL0578-0503-4-71	80
FX8C-100P-SV(71)	CL0578-0505-0-71	100
FX8C-120P-SV(71)	CL0578-0506-2-71	120
FX8C-140P-SV(71)	CL0578-0507-5-71	140

■ FX8C Straight Header (Standard Product Height + 1mm Product)

Part No.	HRS No.	No. of Pos.
FX8C-60P-SV1(71)	CL0578-0521-6-71	60
FX8C-80P-SV1(71)	CL0578-0523-1-71	80
FX8C-100P-SV1(71)	CL0578-0525-7-71	100
FX8C-120P-SV1(71)	CL0578-0526-0-71	120
FX8C-140P-SV1(71)	CL0578-0527-2-71	140

■ FX8C Straight Header (Standard Product Height +2mm Product)

Part No.	HRS No.	No. of Pos.
FX8C-60P-SV2(71)	CL0578-0541-3-71	60
FX8C-80P-SV2(71)	CL0578-0543-9-71	80
FX8C-100P-SV2(71)	CL0578-0545-4-71	100
FX8C-120P-SV2(71)	CL0578-0546-7-71	120
FX8C-140P-SV2(71)	CL0578-0547-0-71	140

■ FX8C Straight Header (Standard Product Height +4mm Product)

Part No.	HRS No.	No. of Pos.
FX8C-60P-SV4(71)	CL0578-0581-8-71	60
FX8C-80P-SV4(71)	CL0578-0583-3-71	80
FX8C-100P-SV4(71)	CL0578-0585-9-71	100
FX8C-120P-SV4(71)	CL0578-0586-1-71	120
FX8C-140P-SV4(71)	CL0578-0587-4-71	140

Sep. 1. 2024 Copyright 2024 HIROSE ELECTRIC CO., LTD. All Rights Reserved.

Tray Packing Specifications (FX8C Straight Receptacle)

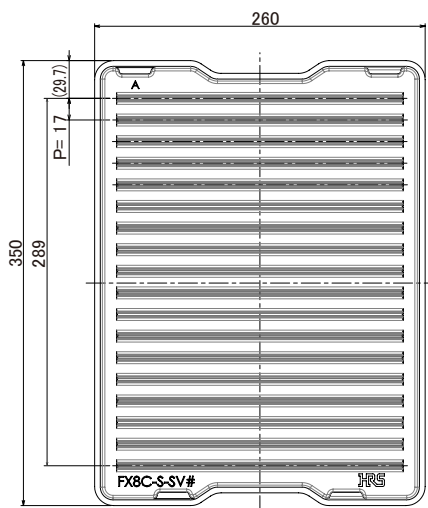

■FX8C Straight Receptacle (Standard Product Height)

Part No.	HRS No.	No. of Pos.
FX8C-60S-SV(71)	CL0578-0801-2-71	60
FX8C-80S-SV(71)	CL0578-0803-8-71	80
FX8C-100S-SV(71)	CL0578-0805-3-71	100
FX8C-120S-SV(71)	CL0578-0806-6-71	120
FX8C-140S-SV(71)	CL0578-0807-9-71	140

■FX8C Straight Receptacle (Product Height +5mm Product)

Part No.	HRS No.	No. of Pos.
FX8C-60S-SV5(71)	CL0578-0821-0-71	60
FX8C-80S-SV5(71)	CL0578-0823-5-71	80
FX8C-100S-SV5(71)	CL0578-0825-0-71	100
FX8C-120S-SV5(71)	CL0578-0826-3-71	120
FX8C-140S-SV5(71)	CL0578-0827-6-71	140

Packaging Specifications of Embossed Tape (FX8 Straight Header)

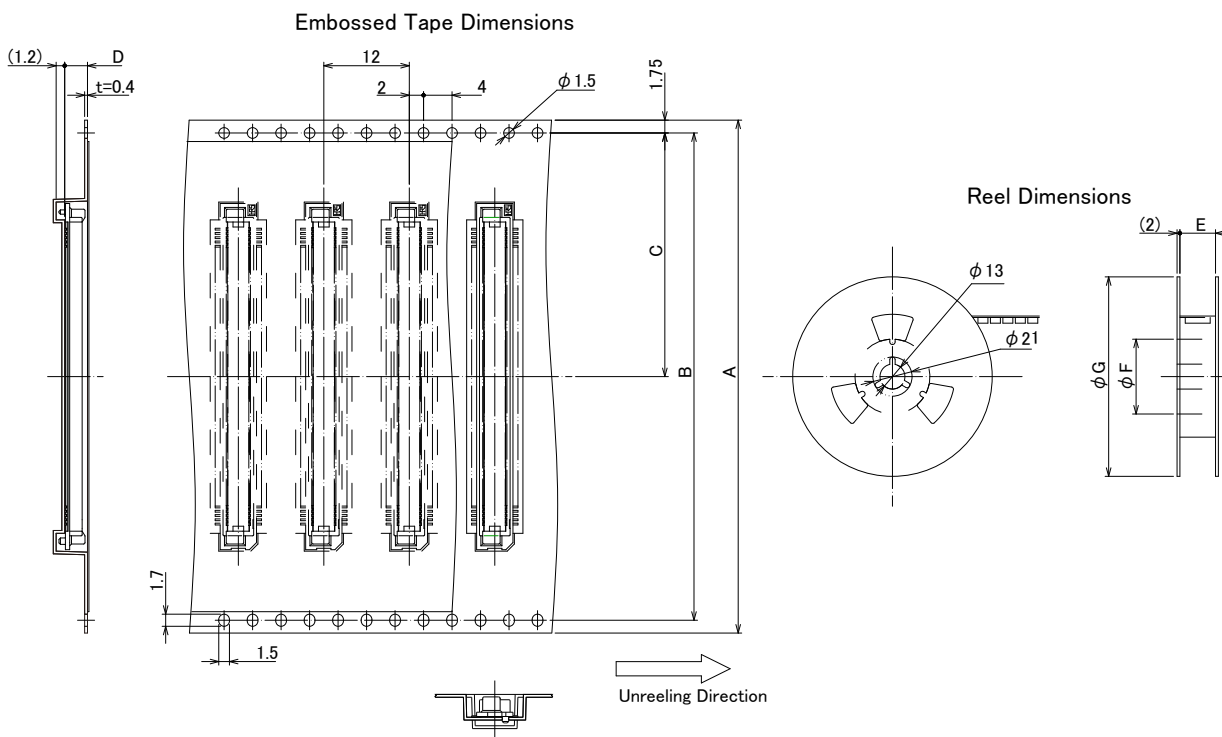

■ FX8 Straight Header (Standard Product Height)

Unit : mm

Part No.	HRS No.	No. of Pos.	A	B	C	D	E	F	G
FX8-60P-SV(92)	CL0578-0001-6-92	60	44	40.4	20.2	3.2	44.4	80	330
FX8-80P-SV(92)	CL0578-0003-1-92	80	44	40.4	20.2	3.2	44.4	80	330
FX8-100P-SV(92)	CL0578-0005-7-92	100	56	52.4	26.2	3.2	56.4	80	330
FX8-120P-SV(92)	CL0578-0006-0-92	120	56	52.4	26.2	3.2	56.4	80	330
FX8-140P-SV(92)	CL0578-0007-2-92	140	72	68.4	34.2	3.2	72.4	80	330

■ FX8 Straight Header (Standard Product Height + 1mm Product)

Unit : mm

Part No.	HRS No.	No. of Pos.	A	B	C	D	E	F	G
FX8-60P-SV1(92)	CL0578-0041-0-92	60	44	40.4	20.2	4.2	44.4	80	330
FX8-80P-SV1(92)	CL0578-0043-6-92	80	44	40.4	20.2	4.2	44.4	80	330
FX8-100P-SV1(92)	CL0578-0045-1-92	100	56	52.4	26.2	4.2	56.4	80	360
FX8-120P-SV1(92)	CL0578-0046-4-92	120	56	52.4	26.2	4.2	56.4	80	360
FX8-140P-SV1(92)	CL0578-0047-7-92	140	72	68.4	34.2	4.2	72.4	80	360

Packaging Specifications of Embossed Tape (FX8 Straight Receptacle)

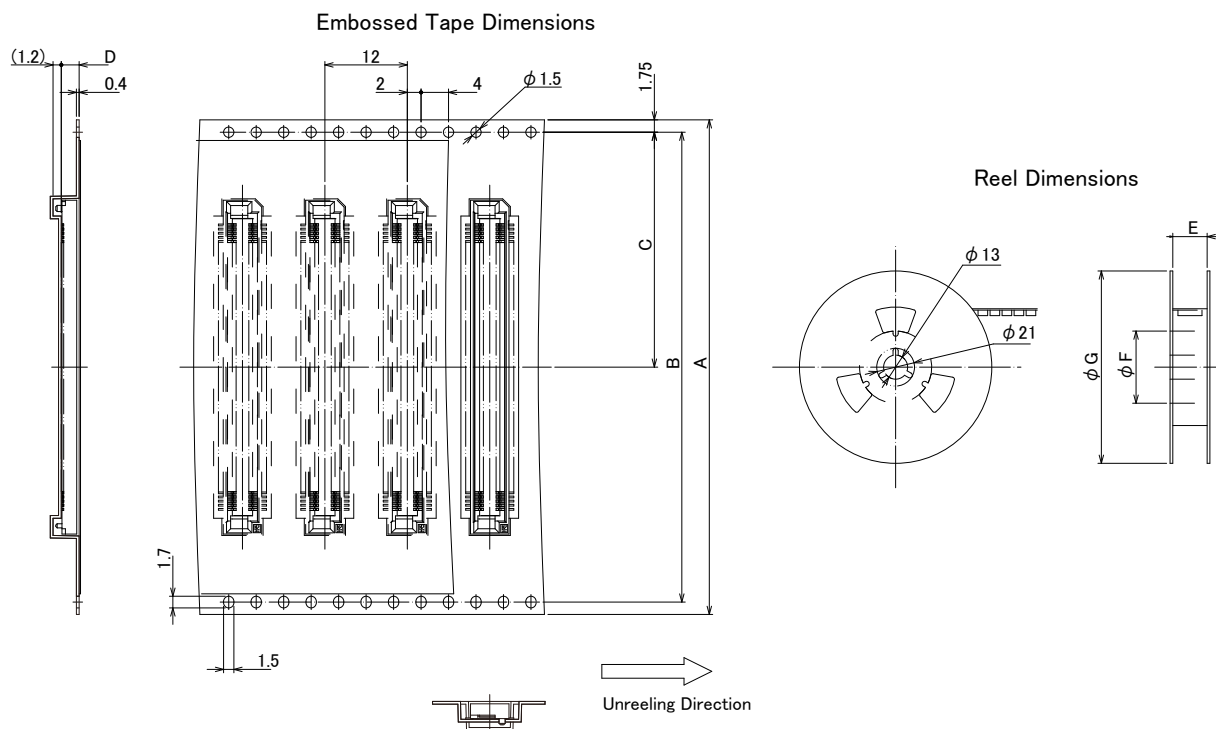

FX8 Straight Receptacle

Unit : mm

Part No.	HRS No.	No. of Pos.	A	B	C	D	E	F	G
FX8-60S-SV(22)	CL0578-0201-5-22	60	44	40.4	20.2	2.6	44.4	80	330
FX8-80S-SV(22)	CL0578-0203-0-22	80	44	40.4	20.2	2.6	44.4	80	330
FX8-100S-SV(22)	CL0578-0205-6-22	100	56	52.4	26.2	2.6	56.4	80	360
FX8-120S-SV(22)	CL0578-0206-9-22	120	56	52.4	26.2	2.6	56.4	80	360
FX8-140S-SV(22)	CL0578-0207-1-22	140	72	68.4	34.2	2.6	72.4	80	360

Packaging Specifications of Embossed Tape (FX8C Straight Header)

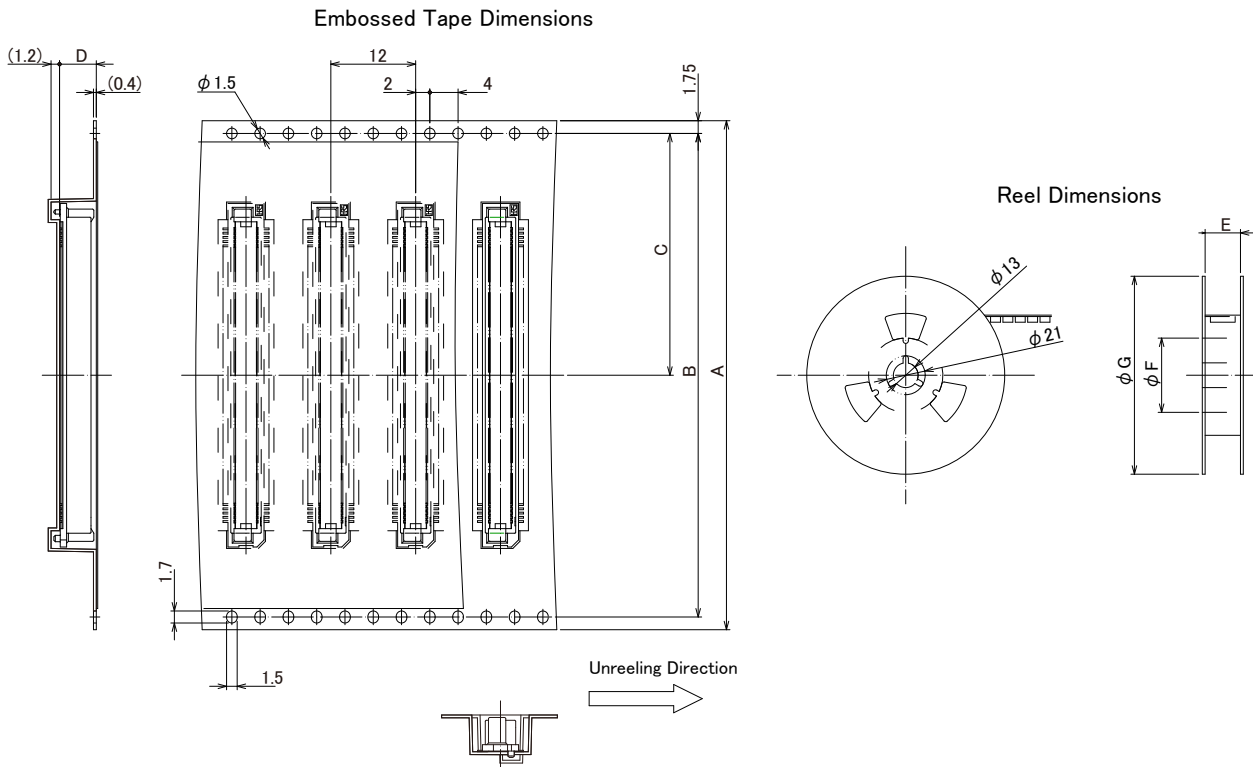

■FX8C Straight Header (Standard Product Height)

Unit : mm

Part No.	HRS No.	No. of Pos.	A	B	C	D	E	F	G
FX8C-60P-SV(92)	CL0578-0501-9-92	60	44	40.4	20.2	5.2	44.4	80	370
FX8C-80P-SV(92)	CL0578-0503-4-92	80	44	40.4	20.2	5.2	44.4	80	370
FX8C-100P-SV(92)	CL0578-0505-0-92	100	56	52.4	26.2	5.2	56.4	80	370
FX8C-120P-SV(92)	CL0578-0506-2-92	120	56	52.4	26.2	5.2	56.4	80	370
FX8C-140P-SV(92)	CL0578-0507-5-92	140	72	68.4	34.2	5.2	72.4	80	370

■FX8C Straight Header (Standard Product Height + 1mm Product)

Unit : mm

Part No.	HRS No.	No. of Pos.	A	B	C	D	E	F	G
FX8C-60P-SV1(92)	CL0578-0521-6-92	60	44	40.4	20.2	6.2	44.4	80	370
FX8C-80P-SV1(92)	CL0578-0523-1-92	80	44	40.4	20.2	6.2	44.4	80	370
FX8C-100P-SV1(92)	CL0578-0525-7-92	100	56	52.4	26.2	6.2	56.4	80	370
FX8C-120P-SV1(92)	CL0578-0526-0-92	120	56	52.4	26.2	6.2	56.4	80	370
FX8C-140P-SV1(92)	CL0578-0527-2-92	140	72	68.4	34.2	6.2	72.4	80	370

■FX8C Straight Header (Standard Product Height +2mm Product)

Unit : mm

Part No.	HRS No.	No. of Pos.	A	B	C	D	E	F	G
FX8C-60P-SV2(92)	CL0578-0541-3-92	60	44	40.4	20.2	7.2	44.4	80	330
FX8C-80P-SV2(92)	CL0578-0543-9-92	80	44	40.4	20.2	7.2	44.4	80	330
FX8C-100P-SV2(92)	CL0578-0545-4-92	100	56	52.4	26.2	7.2	56.4	80	330
FX8C-120P-SV2(92)	CL0578-0546-7-92	120	56	52.4	26.2	7.2	56.4	80	380
FX8C-140P-SV2(92)	CL0578-0547-0-92	140	72	68.4	34.2	7.2	72.4	80	330

■FX8C Straight Header (Standard Product Height +4mm Product)

Unit : mm

Part No.	HRS No.	No. of Pos.	A	B	C	D	E	F	G
FX8C-60P-SV4(92)	CL0578-0581-8-92	60	44	40.4	20.2	9.2	44.4	80	370
FX8C-80P-SV4(92)	CL0578-0583-3-92	80	44	40.4	20.2	9.2	44.4	80	370
FX8C-100P-SV4(92)	CL0578-0585-9-92	100	56	52.4	26.2	9.2	56.4	80	370
FX8C-120P-SV4(92)	CL0578-0586-1-92	120	56	52.4	26.2	9.2	56.4	80	370
FX8C-140P-SV4(92)	CL0578-0587-4-92	140	72	68.4	34.2	9.2	72.4	80	370

■FX8C Straight Header (Standard Product Height +6mm Product)

Unit : mm

Part No.	HRS No.	No. of Pos.	A	B	C	D	E	F	G
FX8C-60P-SV6(92)	CL0578-0601-3-92	60	44	40.4	20.2	11.2	44.4	80	370
FX8C-80P-SV6(92)	CL0578-0603-9-92	80	44	40.4	20.2	11.2	44.4	80	370
FX8C-100P-SV6(92)	CL0578-0605-4-92	100	56	52.4	26.2	11.2	56.4	80	370
FX8C-120P-SV6(92)	CL0578-0606-7-92	120	56	52.4	26.2	11.2	56.4	80	370
FX8C-140P-SV6(92)	CL0578-0607-0-92	140	72	68.4	34.2	11.2	72.4	80	370

Packaging Specifications of Embossed Tape (FX8C Straight Receptacle)

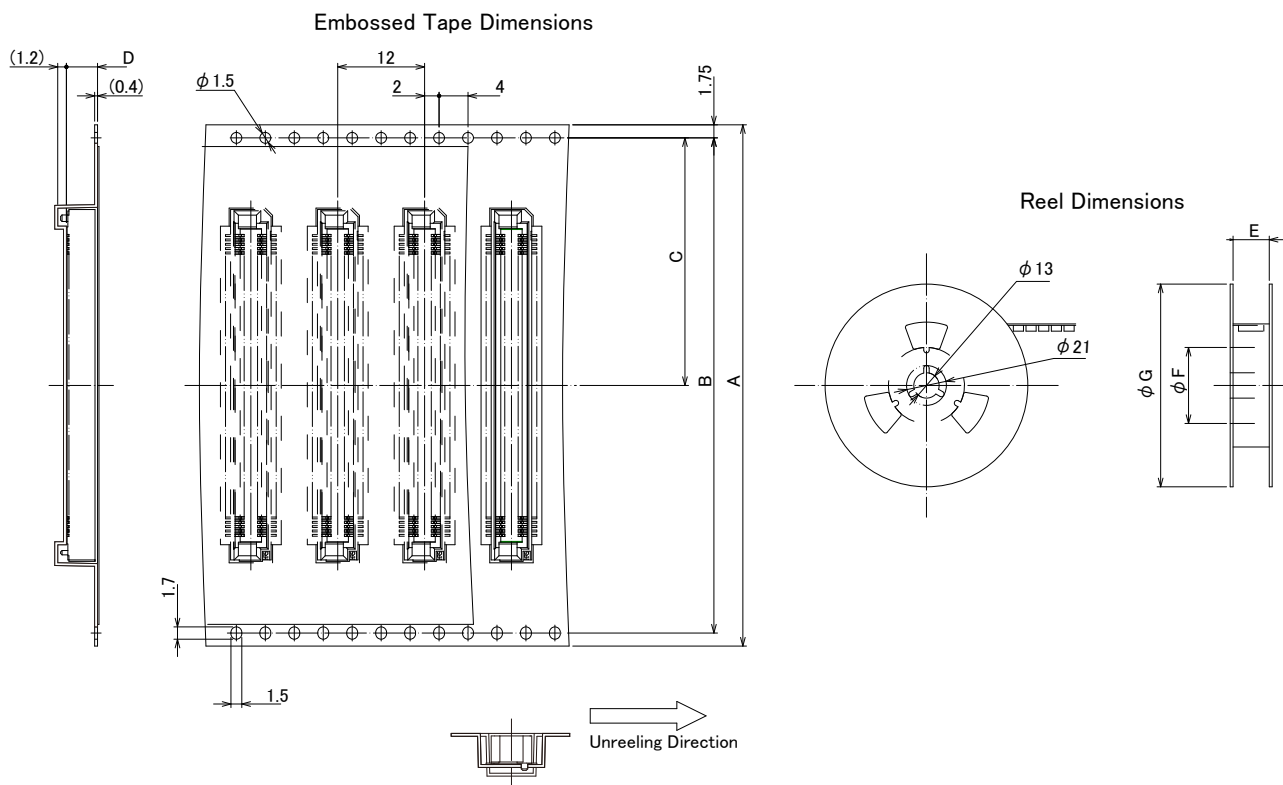

■ FX8C Straight Receptacle (Product Height Standard Product)

Unit : mm

Part No.	HRS No.	No. of Pos.	A	B	C	D	E	F	G
FX8C-60S-SV(92)	CL0578-0801-2-92	60	44	40.4	20.2	4.3	44.4	80	330
FX8C-80S-SV(92)	CL0578-0803-8-92	80	44	40.4	20.2	4.3	44.4	80	330
FX8C-100S-SV(92)	CL0578-0805-3-92	100	56	52.4	26.2	4.3	56.4	80	330
FX8C-120S-SV(92)	CL0578-0806-6-92	120	56	52.4	26.2	4.3	56.4	80	330
FX8C-140S-SV(92)	CL0578-0807-9-92	140	72	68.4	34.2	4.3	72.4	100	370

■ FX8C Straight Receptacle (Product Height +5mm Product)

Unit : mm

Part No.	HRS No.	No. of Pos.	A	B	C	D	E	F	G
FX8C-60S-SV5(92)	CL0578-0821-0-92	60	44	40.4	20.2	9.3	44.4	80	370
FX8C-80S-SV5(92)	CL0578-0823-5-92	80	44	40.4	20.2	9.3	44.4	80	370
FX8C-100S-SV5(92)	CL0578-0825-0-92	100	56	52.4	26.2	9.3	56.4	80	370
FX8C-120S-SV5(92)	CL0578-0826-3-92	120	56	52.4	26.2	9.3	56.4	80	380
FX8C-140S-SV5(92)	CL0578-0827-6-92	140	72	68.4	34.2	9.3	72.4	80	380

Recommended Temperature Profile

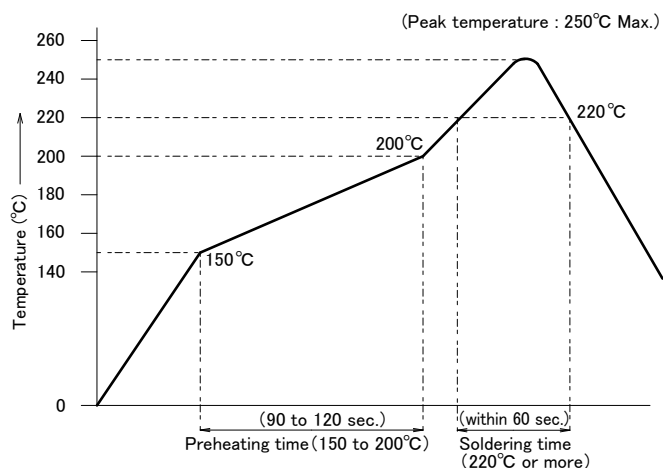

<Applicable Conditions>

Test PCB Dimensions : 161 × 100 × 1.6mm

Material : Glass epoxy

Solder Composition : Sn-3Ag-0.5Cu

Flux Content : 11wt%

Metal Mask Thickness : 0.15mm

Number of Reflow Times : 2 times Max.

*The temperature profile provided is a reference based on the settings above. Actual profiles may vary with different solder paste types, manufacturers, PCB sizes, and other soldering materials. Please verify the mounting conditions before use.

While Taking into Consideration

Specifications mentioned in this catalog are reference values.

When considering to order or use this product, please review the Drawing and Product Specifications sheets.

Use an appropriate cable when using the connector in combination with cables.

If considering usage of a non-specified cable, please contact your sales representative.

If assembly process is done by jigs & tools which are not identified by Hirose, the warranty of the product may be affected.

If considering usage for below mentioned applications, please contact your sales representative.

In cases where the application will demand a high level of reliability, such as automotive, medical instruments, public infrastructure, aerospace/defense etc. Hirose must review before assurance of reliability can be given.