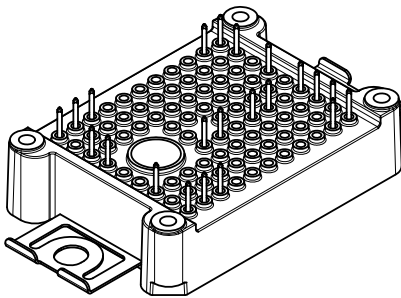
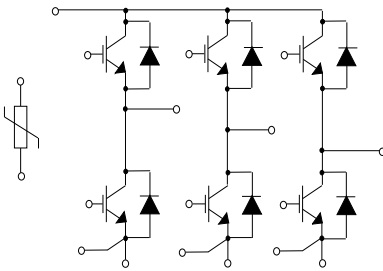

ACEPACK™ 1 sixpack topology, 1200 V, 25 A, trench gate field-stop M series IGBT with soft diode and NTC

ACEPACK™ 1

Features

- ACEPACK™ 1 power module
 - DBC Cu Al₂O₃ Cu
- Sixpack topology
 - 1200 V, 25 A IGBTs and diodes
 - Soft and fast recovery diode
- Integrated NTC

Applications

- Inverters
- Industrial
- Motor drives

Description

This power module is a sixpack topology in an ACEPACK™ 1 package with NTC, integrating the advanced trench gate field-stop technologies from STMicroelectronics. This new IGBT technology represents the best compromise between conduction and switching loss, to maximize the efficiency of any converter system up to 20 kHz.



Product status

A1P25S12M3

Product summary

Order code	A1P25S12M3
Marking	A1P25S12M3
Package	ACEPACK™ 1
Leads type	Solder contact pins

1 Electrical ratings

1.1 IGBT

Limiting values at $T_J = 25\text{ °C}$, unless otherwise specified.

Table 1. Absolute maximum ratings of the IGBT

Symbol	Parameter	Value	Unit
V_{CES}	Collector-emitter voltage ($V_{GE} = 0\text{ V}$)	1200	V
I_C	Continuous collector current ($T_C = 100\text{ °C}$)	25	A
$I_{CP}^{(1)}$	Pulsed collector current ($t_p = 1\text{ ms}$)	50	A
V_{GE}	Gate-emitter voltage	± 20	V
P_{TOT}	Total power dissipation of each IGBT ($T_C = 25\text{ °C}$, $T_J = 175\text{ °C}$)	197	W
T_{JMAX}	Maximum junction temperature	175	°C
T_{Jop}	Operating junction temperature range under switching conditions	-40 to 150	°C

1. Pulse width limited by maximum junction temperature.

Table 2. Electrical characteristics of the IGBT

Symbol	Parameter	Test conditions	Min.	Typ.	Max.	Unit
$V_{(BR)CES}$	Collector-emitter breakdown voltage	$I_C = 1\text{ mA}$, $V_{GE} = 0\text{ V}$	1200			V
$V_{CE(sat)}$ (terminal)	Collector-emitter saturation voltage	$V_{GE} = 15\text{ V}$, $I_C = 25\text{ A}$		1.95	2.45	V
		$V_{GE} = 15\text{ V}$, $I_C = 25\text{ A}$, $T_J = 150\text{ °C}$		2.3		
$V_{GE(th)}$	Gate threshold voltage	$V_{CE} = V_{GE}$, $I_C = 1\text{ mA}$	5	6	7	V
I_{CES}	Collector cut-off current	$V_{GE} = 0\text{ V}$, $V_{CE} = 1200\text{ V}$			100	μA
I_{GES}	Gate-emitter leakage current	$V_{CE} = 0\text{ V}$, $V_{GE} = \pm 20\text{ V}$			± 500	nA
C_{ies}	Input capacitance	$V_{CE} = 25\text{ V}$, $f = 1\text{ MHz}$, $V_{GE} = 0\text{ V}$		1550		pF
C_{oes}	Output capacitance			130		pF
C_{res}	Reverse transfer capacitance			65		pF
Q_g	Total gate charge	$V_{CC} = 960\text{ V}$, $I_C = 25\text{ A}$, $V_{GE} = \pm 15\text{ V}$		122		nC
$t_{d(on)}$	Turn-on delay time	$V_{CC} = 600\text{ V}$, $I_C = 25\text{ A}$, $R_G = 15\text{ }\Omega$, $V_{GE} = \pm 15\text{ V}$, $di/dt = 1247\text{ A}/\mu\text{s}$		121		ns
t_r	Current rise time			17		ns
$E_{on}^{(1)}$	Turn-on switching energy			1.08		mJ
$t_{d(off)}$	Turn-off delay time	$V_{CC} = 600\text{ V}$, $I_C = 25\text{ A}$, $R_G = 15\text{ }\Omega$, $V_{GE} = \pm 15\text{ V}$, $dv/dt = 10200\text{ V}/\mu\text{s}$		119		ns
t_f	Current fall time			127		ns
$E_{off}^{(2)}$	Turn-off switching energy			1.12		mJ

Symbol	Parameter	Test conditions	Min.	Typ.	Max.	Unit	
$t_{d(on)}$	Turn-on delay time	$V_{CC} = 600\text{ V}$, $I_C = 25\text{ A}$, $R_G = 15\ \Omega$, $V_{GE} = \pm 15\text{ V}$, $di/dt = 1100\text{ A}/\mu\text{s}$, $T_J = 150\text{ }^\circ\text{C}$		121		ns	
t_r	Current rise time			18		ns	
$E_{on}^{(1)}$	Turn-on switching energy				1.65		mJ
$t_{d(off)}$	Turn-off delay time	$V_{CC} = 600\text{ V}$, $I_C = 25\text{ A}$, $R_G = 15\ \Omega$, $V_{GE} = \pm 15\text{ V}$, $dv/dt = 8300\text{ V}/\mu\text{s}$, $T_J = 150\text{ }^\circ\text{C}$		125		ns	
t_f	Current fall time				201		ns
$E_{off}^{(2)}$	Turn-off switching energy				1.66		mJ
t_{SC}	Short-circuit withstand time	$V_{CC} \leq 600\text{ V}$, $V_{GE} \leq 15\text{ V}$, $T_{Jstart} \leq 150\text{ }^\circ\text{C}$	10			μs	
R_{THj-c}	Thermal resistance junction-to-case	Each IGBT		0.69	0.76	$^\circ\text{C}/\text{W}$	
R_{THc-h}	Thermal resistance case-to-heatsink	Each IGBT, $\lambda_{grease} = 1\text{ W}/(\text{m}\cdot^\circ\text{C})$		0.79		$^\circ\text{C}/\text{W}$	

1. Including the reverse recovery of the diode.
2. Including the tail of the collector current.

1.2 Diode

Limiting values at $T_J = 25\text{ }^\circ\text{C}$, unless otherwise specified.

Table 3. Absolute maximum ratings of the diode

Symbol	Parameter	Value	Unit
V_{RRM}	Repetitive peak reverse voltage	1200	V
I_F	Continuous forward current ($T_C = 100\text{ }^\circ\text{C}$)	25	A
$I_{FP}^{(1)}$	Pulsed forward current ($t_p = 1\text{ ms}$)	50	A
T_{JMAX}	Maximum junction temperature	175	$^\circ\text{C}$
T_{Jop}	Operating junction temperature range under switching conditions	-40 to 150	$^\circ\text{C}$

1. Pulse width limited by maximum junction temperature.

Table 4. Electrical characteristics of the diode

Symbol	Parameter	Test conditions	Min.	Typ.	Max.	Unit
V_F (terminal)	Forward voltage	$I_F = 25 \text{ A}$	-	2.95	4.1	V
		$I_F = 25 \text{ A}, T_J = 150 \text{ }^\circ\text{C}$	-	2.3		
t_{rr}	Reverse recovery time	$I_F = 25 \text{ A}, V_R = 600 \text{ V},$ $V_{GE} = \pm 15 \text{ V}, di/dt = 1247 \text{ A}/\mu\text{s}$	-	190		ns
Q_{rr}	Reverse recovery charge		-	1.55		μC
I_{rrm}	Reverse recovery current		-	29		A
E_{rec}	Reverse recovery energy		-	0.71		mJ
t_{rr}	Reverse recovery time	$I_F = 25 \text{ A}, V_R = 600 \text{ V},$ $V_{GE} = \pm 15 \text{ V}, di/dt = 1100 \text{ A}/\mu\text{s},$ $T_J = 150 \text{ }^\circ\text{C}$	-	400		ns
Q_{rr}	Reverse recovery charge		-	4.0		μC
I_{rrm}	Reverse recovery current		-	37		A
E_{rec}	Reverse recovery energy		-	2.05		mJ
R_{THj-c}	Thermal resistance junction-to-case	Each diode	-	1.05	1.16	$^\circ\text{C}/\text{W}$
R_{THc-h}	Thermal resistance case-to-heatsink	Each diode, $\lambda_{grease} = 1 \text{ W}/(\text{m}\cdot^\circ\text{C})$	-	0.85		$^\circ\text{C}/\text{W}$

1.3
NTC
Table 5. NTC temperature sensor, considered as stand-alone

Symbol	Parameter	Test conditions	Min.	Typ.	Max.	Unit
R_{25}	Resistance	$T = 25^\circ\text{C}$		5		k Ω
R_{100}	Resistance	$T = 100^\circ\text{C}$		493		Ω
$\Delta R/R$	Deviation of R_{100}		-5		+5	%
$B_{25/50}$	B-constant			3375		K
$B_{25/80}$	B-constant			3411		K
T	Operating temperature range		-40		150	$^\circ\text{C}$

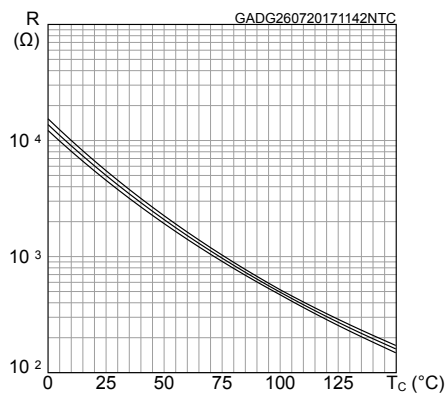
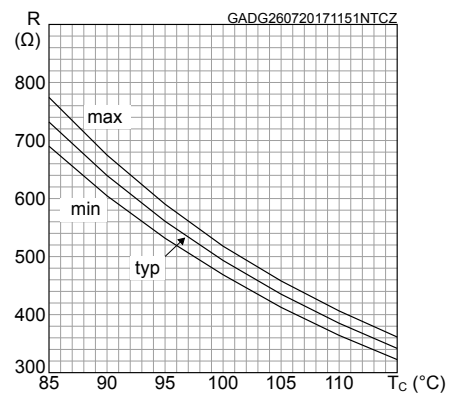
Figure 1. NTC resistance vs temperature

Figure 2. NTC resistance vs temperature, zoom

1.4 Package

Table 6. ACEPACK™ 1 package

Symbol	Parameter	Min.	Typ.	Max.	Unit
V_{isol}	Isolation voltage (AC voltage, $t = 60$ s)			2500	V
T_{stg}	Storage temperature	-40		125	°C
CTI	Comparative tracking index	200			
L_s	Stray inductance module P1 - EW loop		28.7		nH
R_s	Module single lead resistance, terminal-to-chip		3.9		mΩ

2 Electrical characteristics (curves)

Figure 3. IGBT output characteristics
($V_{GE} = 15\text{ V}$, terminal)

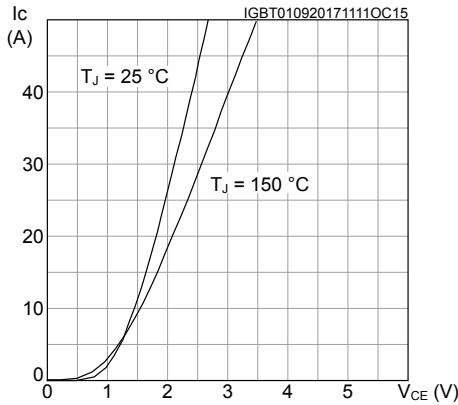

Figure 4. IGBT output characteristics
($T_J = 150\text{ °C}$, terminal)

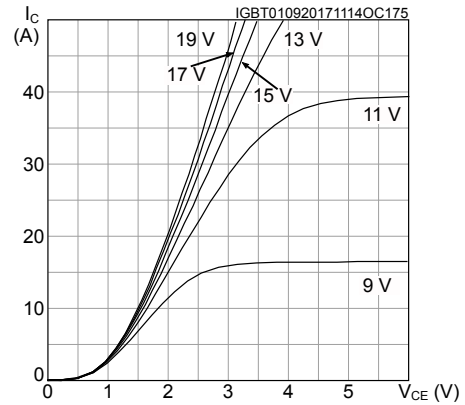

Figure 5. IGBT transfer characteristics
($V_{CE} = 15\text{ V}$, terminal)

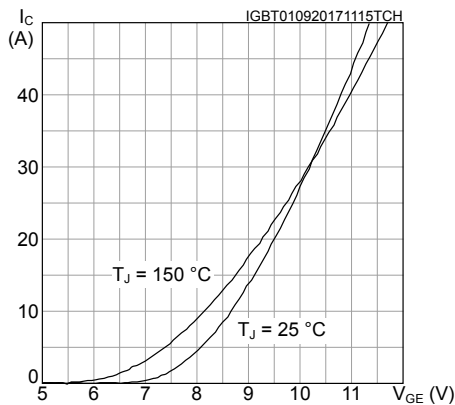

Figure 6. IGBT collector current vs case temperature

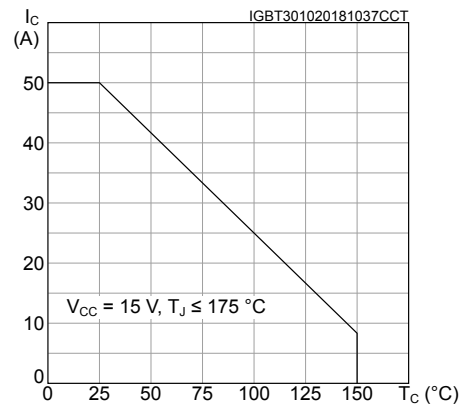

Figure 7. Switching energy vs gate resistance

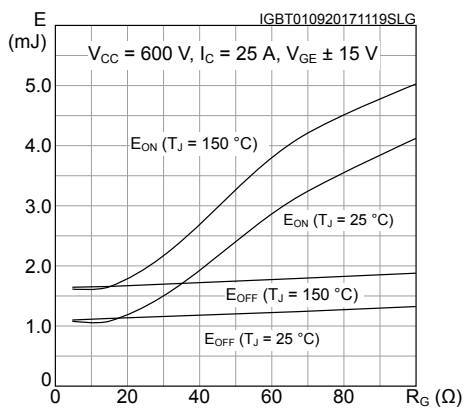

Figure 8. Switching energy vs collector current

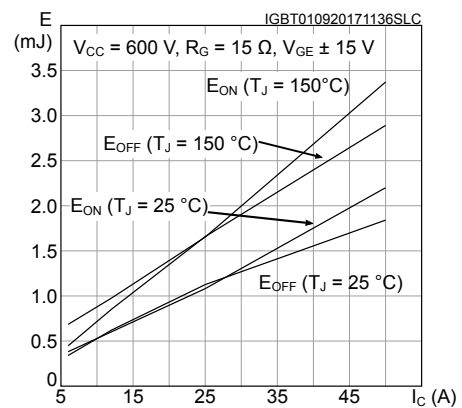

Figure 9. IGBT reverse biased safe operating area (RBSOA)

Figure 10. Diode forward characteristics (terminal)

Figure 11. Diode reverse recovery energy vs diode current slope

Figure 12. Diode reverse recovery energy vs forward current

Figure 13. Diode reverse recovery energy vs gate resistance

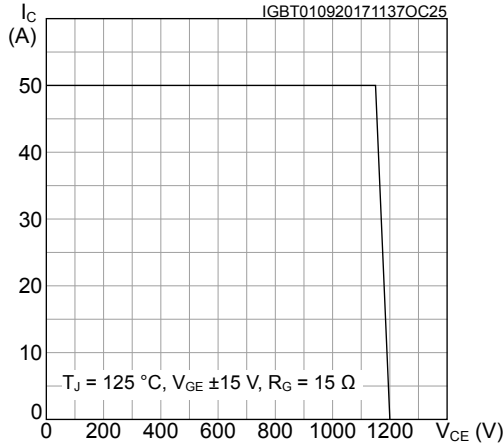
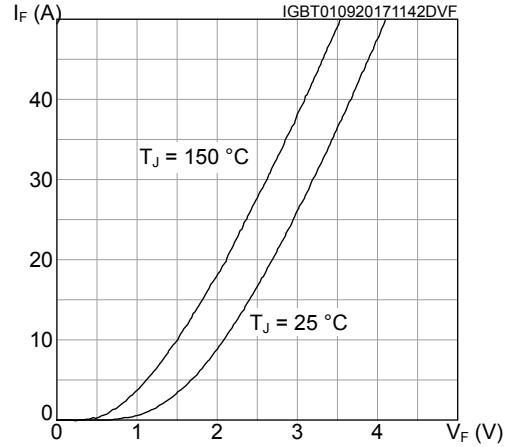
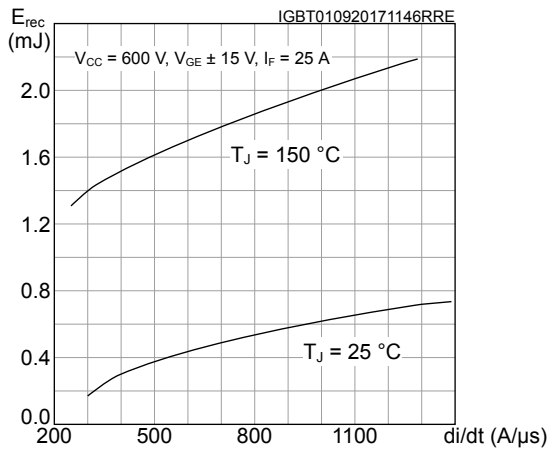
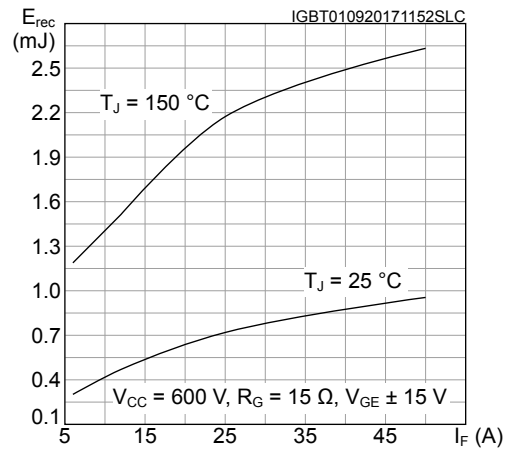
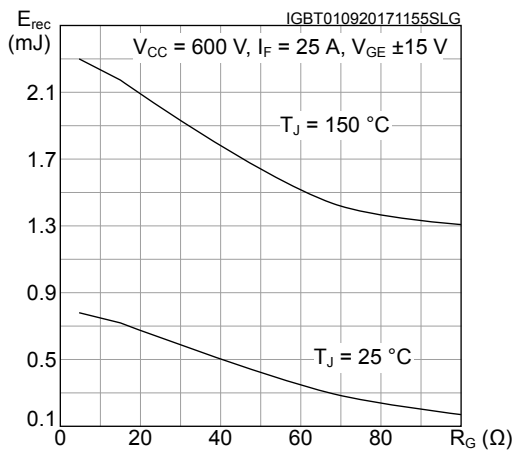
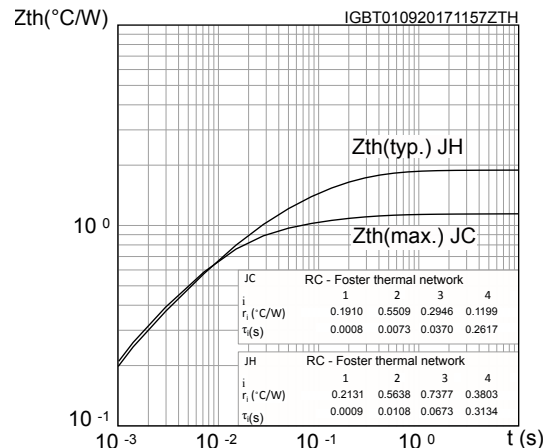
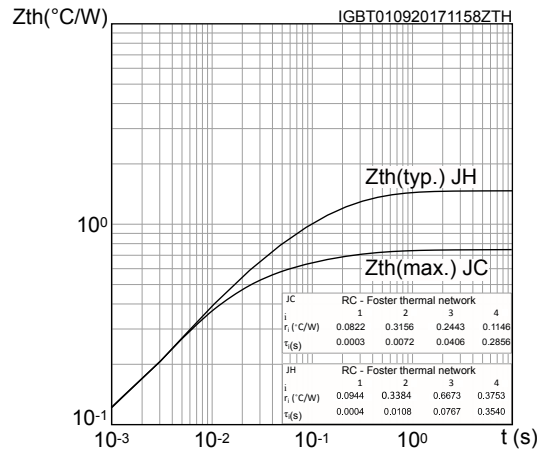
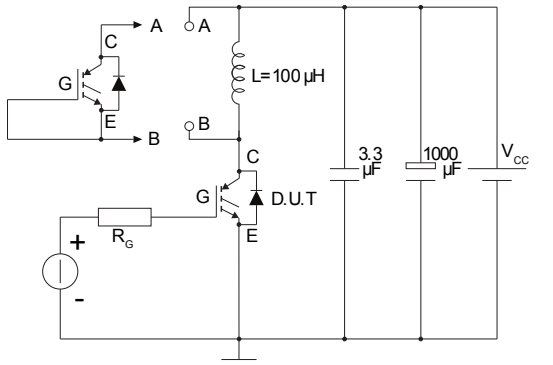
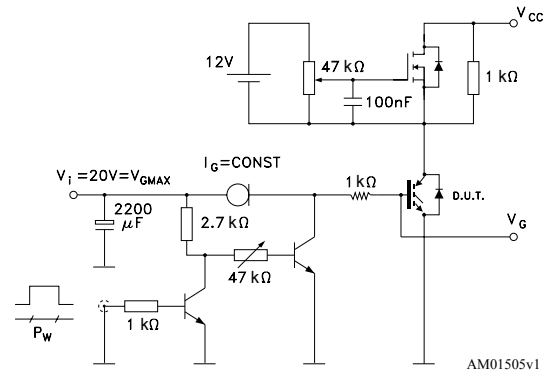
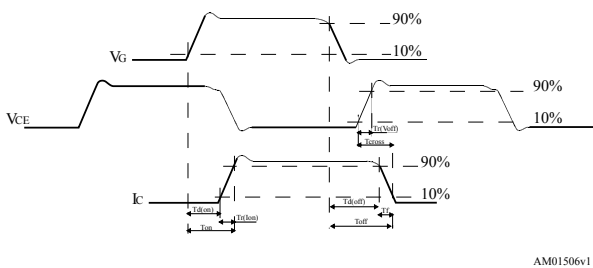
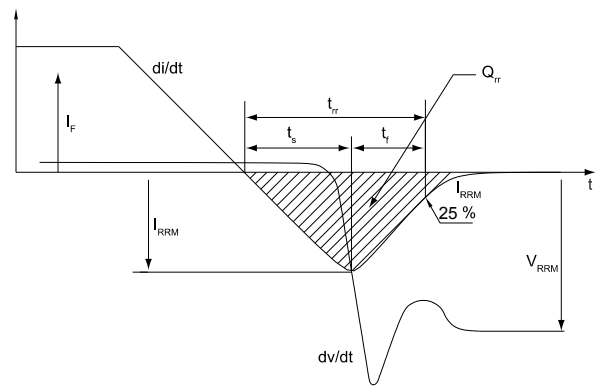
Figure 14. Inverter diode thermal impedance

Figure 15. IGBT thermal impedance



3 Test circuits

Figure 16. Test circuit for inductive load switching

Figure 17. Gate charge test circuit

Figure 18. Switching waveform

Figure 19. Diode reverse recovery waveform

4 Topology and pin description

Figure 20. Electrical topology and pin description

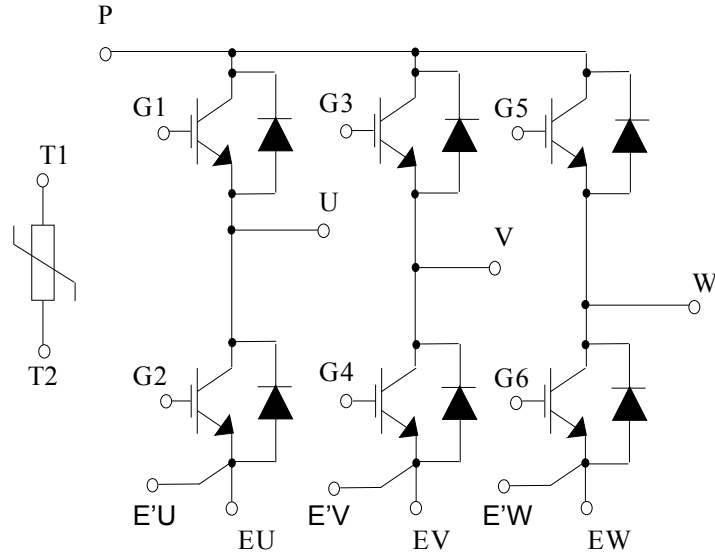
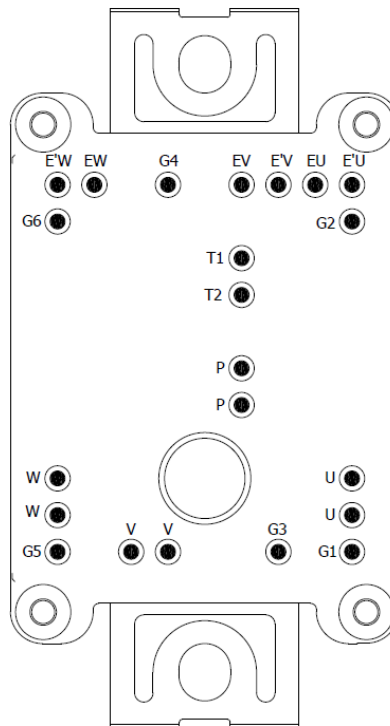

Figure 21. Package top view with sixpack pinout



5 **Package information**

In order to meet environmental requirements, ST offers these devices in different grades of **ECOPACK®** packages, depending on their level of environmental compliance. ECOPACK® specifications, grade definitions and product status are available at: www.st.com. ECOPACK® is an ST trademark.

Revision history

Table 7. Document revision history

Date	Revision	Changes
01-Sep-2017	1	Initial release.
03-Oct-2017	2	Document status promoted from preliminary data to production data. Updated <i>Table 7: "ACEPACK™ 1 package"</i> and <i>Section 2: "Electrical characteristics curves"</i> . Minor text changes.
16-Feb-2018	3	Updated features and removed maturity status indication from cover page. Updated <i>Figure 13. Inverter diode thermal impedance</i> and <i>Figure 14. IGBT thermal impedance</i> . Updated <i>Figure 21. ACEPACK™ 1 sixpack solder pins package outline (dimensions are in mm)</i> . Minor text changes
14-Nov-2018	4	Added Figure 6. IGBT collector current vs case temperature . Minor text changes

Contents

1	Electrical ratings	2
1.1	IGBT	2
1.2	Diode	3
1.3	NTC.....	4
1.4	Package	5
2	Electrical characteristics (curves)	6
3	Test circuits	9
4	Topology and pin description	10
5	Package information	11
5.1	ACEPACK™ 1 sixpack solder pins package information	12
	Revision history	13

IMPORTANT NOTICE – PLEASE READ CAREFULLY

STMicroelectronics NV and its subsidiaries (“ST”) reserve the right to make changes, corrections, enhancements, modifications, and improvements to ST products and/or to this document at any time without notice. Purchasers should obtain the latest relevant information on ST products before placing orders. ST products are sold pursuant to ST’s terms and conditions of sale in place at the time of order acknowledgement.

Purchasers are solely responsible for the choice, selection, and use of ST products and ST assumes no liability for application assistance or the design of Purchasers’ products.

No license, express or implied, to any intellectual property right is granted by ST herein.

Resale of ST products with provisions different from the information set forth herein shall void any warranty granted by ST for such product.

ST and the ST logo are trademarks of ST. All other product or service names are the property of their respective owners.

Information in this document supersedes and replaces information previously supplied in any prior versions of this document.

© 2018 STMicroelectronics – All rights reserved