

Compensated High Current Choke, 1-phase



See below:

**Approvals and Compliances**

**Description**

- Current compensated choke
- 1-phase choke
- THT-terminals
- Flange for mounting onto printed circuit board

**Unique Selling Proposition**

- Compact size and light weight
- Open design for optimal cooling
- Nanocrystalline or ferrite ring cores
- Customer specific pin outs available

**Applications**

- Frequency converter
- Charge stations
- UPS-systems
- Switching power supplies

**References**

Substitute for type [DKIL-1](#)

**Weblinks**

[pdf datasheet](#), [html-datasheet](#), [General Product Information](#), [Distributor-Stock-Check](#), [Detailed request for product](#), [SPICE Library](#), [Landing Page](#)

**Technical Data**

Rated voltage	IEC, UL: 300VAC	Test Voltage	2500VDC, 2 sec, winding to winding	
	CSA: 250 VAC		Climatic Category	40/100/21 acc. to IEC 60068-1
	max. 425 VDC			Allowable Operation Temp.
Rated Current	10 - 50A @ Ta 40 °C			
Rated inductance	0.15 - 6.9mH, Tol. -30% +50%			
Power Operating Frequency	0 - 400Hz			
Terminal Type	THT			
Weight	30 - 115g			
Material: Housing	UL 94V-0			

**Approvals and Compliances**

Detailed information on product approvals, code requirements, usage instructions and detailed test conditions can be looked up in [Details about Approvals](#)

SCHURTER products are designed for use in industrial environments. They have approvals from independent testing bodies according to national and international standards. Products with specific characteristics and requirements such as required in the automotive sector according to IATF 16949, medical technology according to ISO 134485 or in the aerospace industry can be offered exclusively with customer-specific, individual agreements by SCHURTER.

**Approvals**

The approval mark is used by the testing authorities to certify compliance with the safety requirements placed on electronic products.

Approval Reference Type: DKIH-1

Approval Logo	Certificates	Certification Body	Description
	VDE Approvals	VDE	Certificate Number: 40043700
	UL Approvals	UL	UL File Number: E72928





**Application standards**

Application standards where the product can be used

Organization	Design	Standard	Description
	Designed for applications acc.	IEC/UL 60950	IEC 60950-1 includes the basic requirements for the safety of information technology equipment.

## Compliances

The product complies with following Guide Lines

Identification	Details	Initiator	Description
	CE declaration of conformity	SCHURTER AG	The CE marking declares that the product complies with the applicable requirements laid down in the harmonisation of Community legislation on its affixing in accordance with EU Regulation 765/2008.
	RoHS	SCHURTER AG	EU Directive RoHS 2011/65/EU
	China RoHS	SCHURTER AG	The law SJ / T 11363-2006 (China RoHS) has been in force since 1 March 2007. It is similar to the EU directive RoHS.
	REACH	SCHURTER AG	On 1 June 2007, Regulation (EC) No 1907/2006 on the Registration, Evaluation, Authorization and Restriction of Chemicals 1 (abbreviated as "REACH") entered into force.

## Dimensions [mm]

37-10

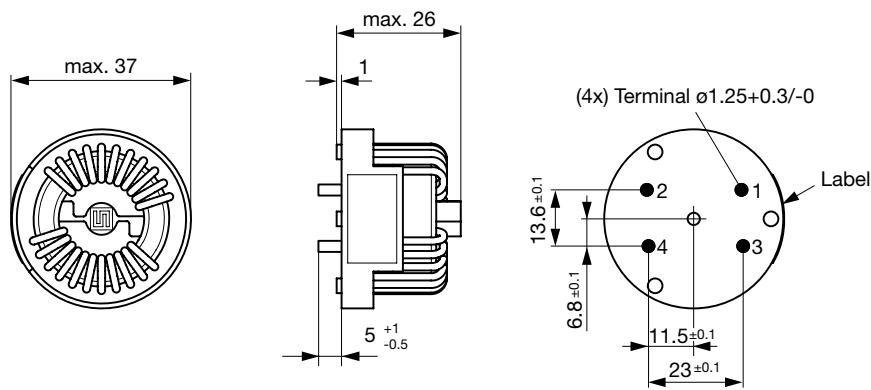

37-12

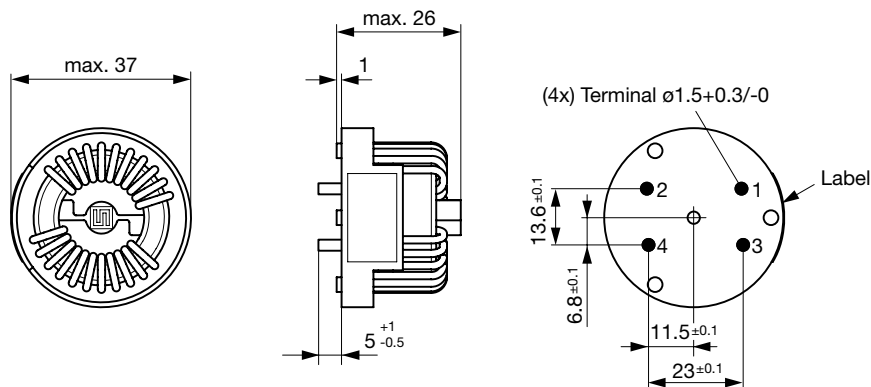

42-16

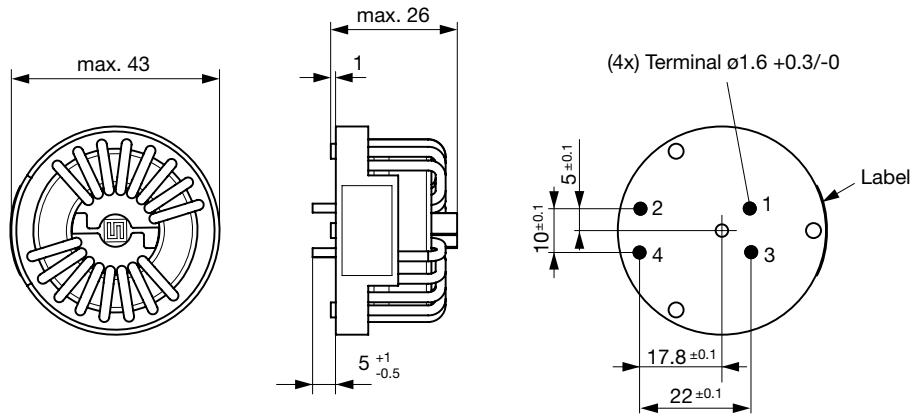

42-20

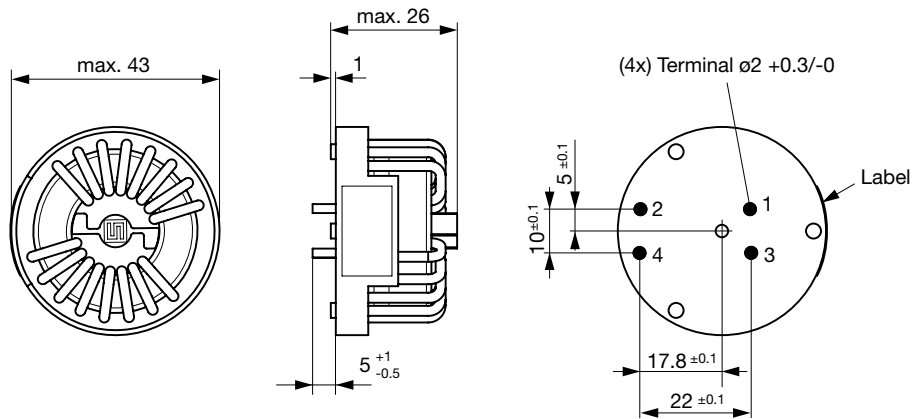

42-25

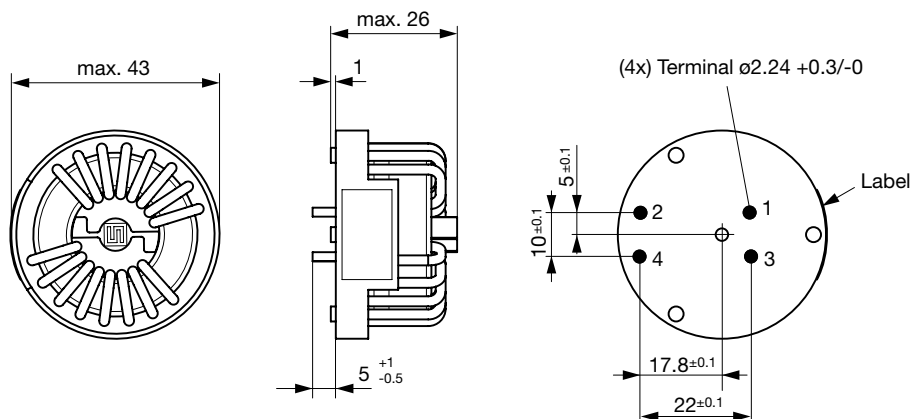

52-32

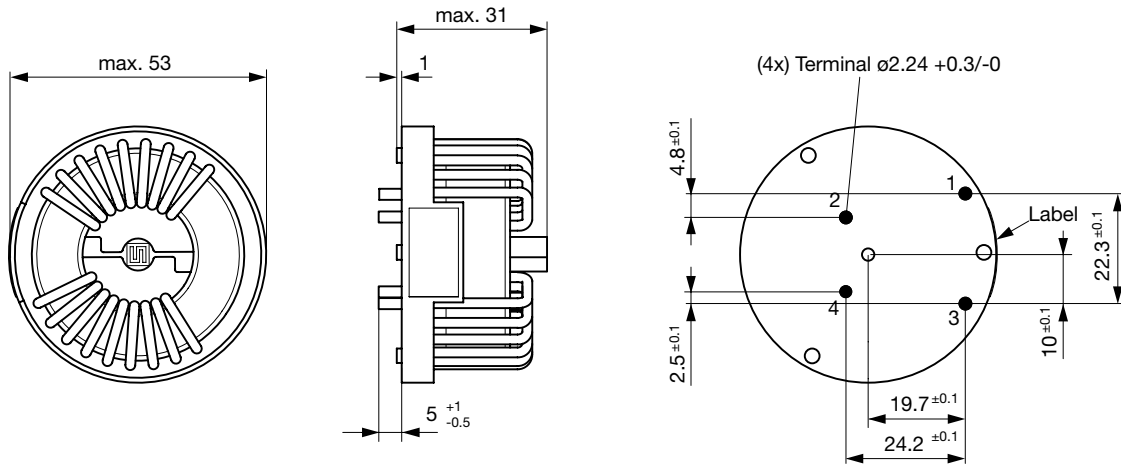

52-40

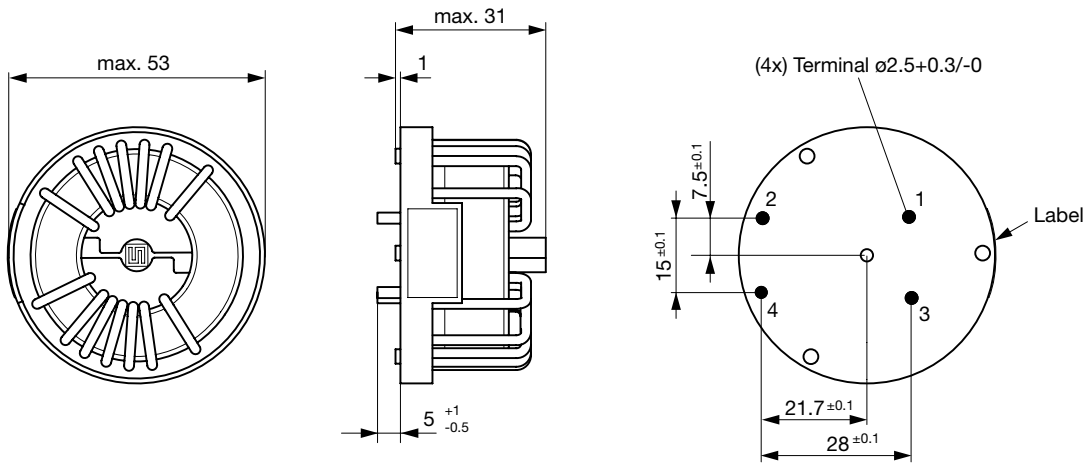

52-50

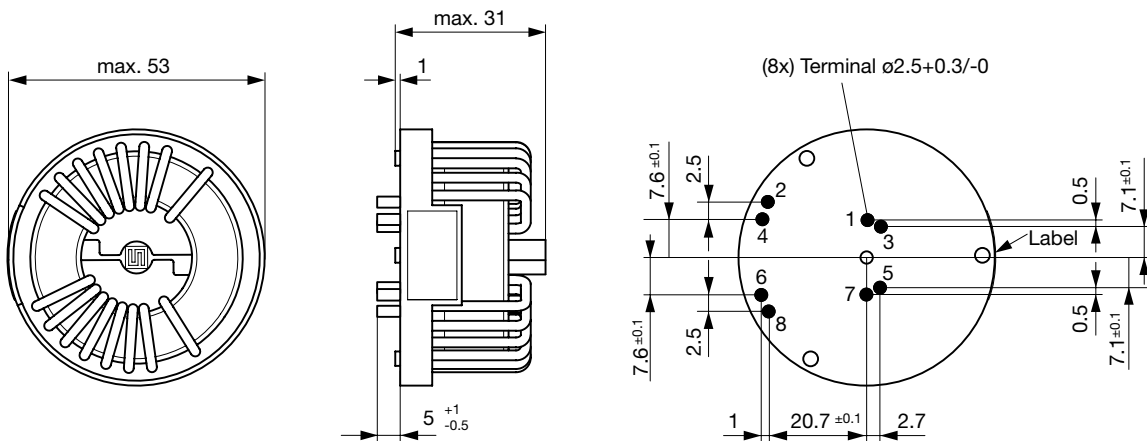

Diagrams

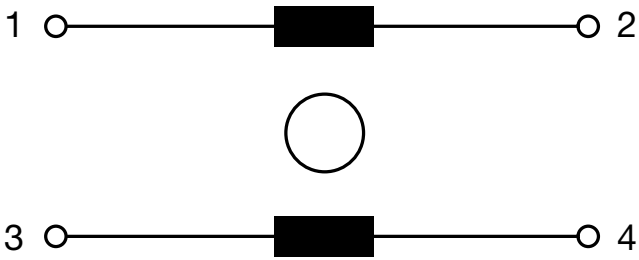

1 phase

DKIH-3237-xxxx

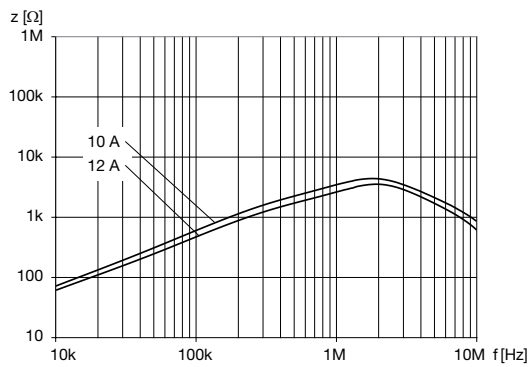

DKIH-3237-xxxx-NK

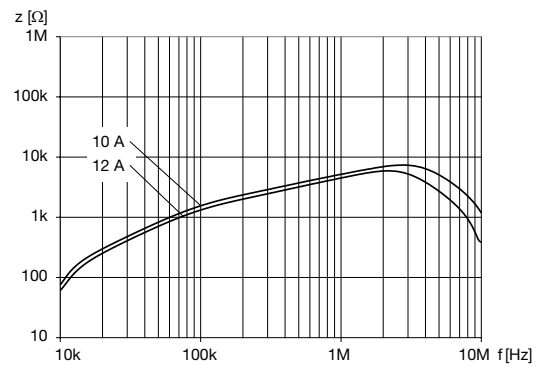

DKIH-3242-xxxx

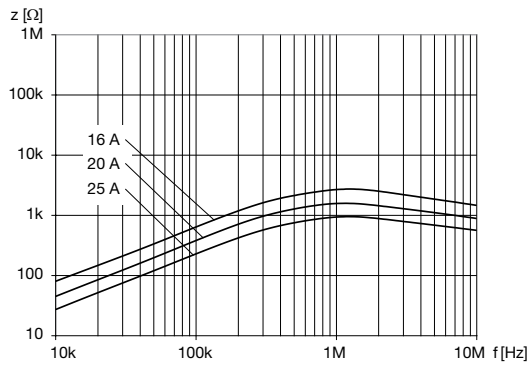

DKIH-3242-xxxx-NK

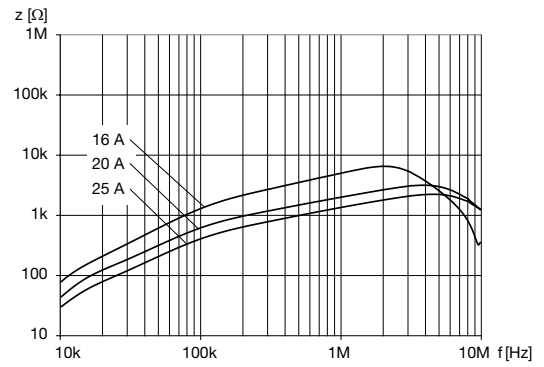

DKIH-3252-xxxx

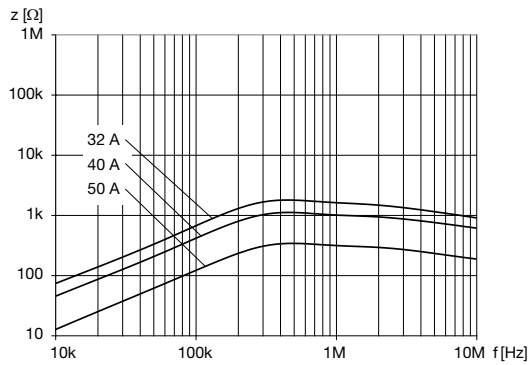

DKIH-3252-xxxx-NK

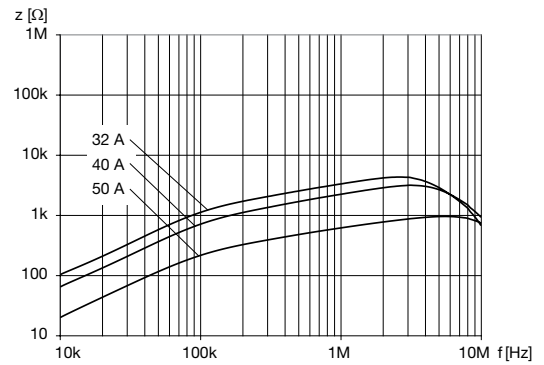

## All Variants

$I_n$ [A]	$L_n$ [mH]	$R_{Cu}$ [mΩ]	Tripped Power Dissipation [W]	$f_{RES}$ [MHz]	Copper $\phi$ [mm]	Weight [g]	Housings	Packing unit [pcs.]	Order Number
10	6.9	10	2	2.2	1.25	30 g	37-10	40	DKIH-3237-1010-NK
10	0.8	10	2	2	1.25	30 g	37-10	40	DKIH-3237-10D8
12	6.8	7	2	2.5	1.5	40 g	37-12	40	DKIH-3237-122Q-NK
12	0.7	7	2	2	1.5	40 g	37-12	40	DKIH-3237-12D7
16	6.9	5.6	2.9	2	1.6	45 g	42-16	20	DKIH-3242-160Q-NK
16	0.9	5.6	2.9	1.5	1.6	45 g	42-16	20	DKIH-3242-16D9
20	3.7	2.5	2	4	2	50 g	42-20	20	DKIH-3242-202M-NK
20	0.5	2.5	2	1.5	2	50 g	42-20	20	DKIH-3242-20D5
25	2.35	1.6	2	5	2.24	50 g	42-25	20	DKIH-3242-257K-NK
25	0.3	1.6	2	1.5	2.24	50 g	42-25	20	DKIH-3242-25D3
32	7.2	2.3	4.7	2.5	2.24	105 g	52-32	20	DKIH-3252-324Q-NK
32	0.75	2.3	4.7	0.4	2.24	105 g	52-32	20	DKIH-3252-32D8
40	4.3	1.5	4.8	3	2.5	115 g	52-40	20	DKIH-3252-409M-NK
40	0.45	1.5	4.8	0.4	2.5	115 g	52-40	20	DKIH-3252-40D5
50	1.4	0.5	2.5	6	2 x 2.5	115 g	52-50	20	DKIH-3252-506J-NK
50	0.15	0.5	2.5	0.4	2 x 2.5	115 g	52-50	20	DKIH-3252-50D2

Most Popular:

Availability for all products can be searched real-time: <https://www.schurter.com/en/Stock-Check/Stock-Check-SCHURTER>

## Accessories

## Description



DKIH-EVB  
Evaluation Board for DKIH-1

# Mouser Electronics

Authorized Distributor

Click to View Pricing, Inventory, Delivery & Lifecycle Information:

## Schurter:

[DKIH-3352-12D8](#) [DKIH-3358-50C8](#) [DKIH-3358-40D2](#) [DKIH-3352-25D3](#) [DKIH-3358-32D3](#) [DKIH-3352-102J](#) [DKIH-3352-16D5](#) [DKIH-3352-20D4](#) [DKIH-3237-12D7](#) [DKIH-3242-16D9](#) [DKIH-3242-25D3](#) [DKIH-3242-20D5](#) [DKIH-3237-10D8](#) [DKIH-3252-40D5](#) [DKIH-3252-32D8](#) [DKIH-3252-50D2](#) [DKIH-3237-122Q-NK](#) [DKIH-3242-257K-NK](#) [DKIH-3237-1010-NK](#) [DKIH-3242-202M-NK](#) [DKIH-3242-160Q-NK](#) [DKIH-3352-120Q-NK](#) [DKIH-3358-326K-NK](#) [DKIH-3352-254K-NK](#) [DKIH-3352-162N-NK](#) [DKIH-3358-50D7-NK](#) [DKIH-3352-1011-NK](#) [DKIH-3352-204L-NK](#) [DKIH-3252-506J-NK](#) [DKIH-3252-409M-NK](#) [DKIH-3358-401J-NK](#) [DKIH-3252-324Q-NK](#)