

# Specification of Automotive MLCC (Reference sheet)

- Supplier : Samsung Electro-Mechanics
- Product : Multi-layer Ceramic Capacitor

- Samsung P/N : **CL10B102KB8WPNC**
- Description : **CAP, 1nF, 50V, ± 10%, X7R, 0603**
- AEC-Q200 Qualified

## A. Dimension

### ● Dimension

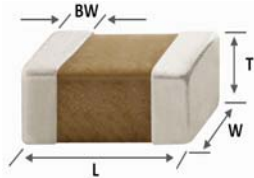

Size	0603 inch
L	1.60±0.10 mm
W	0.80±0.10 mm
T	0.80±0.10 mm
BW	0.30±0.20 mm

## B. Samsung Part Number

**CL** **10** **B** **102** **K** **B** **8** **W** **P** **N** **C**  
 ① ② ③ ④ ⑤ ⑥ ⑦ ⑧ ⑨ ⑩ ⑪

① <b>Series</b>	Samsung Multi-layer Ceramic Capacitor		
② <b>Size</b>	0603 (inch code)	L : 1.60±0.10 mm	W : 0.80±0.10 mm
③ <b>Dielectric</b>	X7R	⑧ <b>Inner electrode</b>	Ni, Open Mode Design
④ <b>Capacitance</b>	1 nF	<b>Termination</b>	Metal-Epoxy
⑤ <b>Capacitance tolerance</b>	± 10%	<b>Plating</b>	Sn 100% (Pb Free)
⑥ <b>Rated Voltage</b>	50 V	⑨ <b>Product</b>	Automotive
⑦ <b>Thickness</b>	0.80±0.10 mm	⑩ <b>Special code</b>	Normal
		⑪ <b>Packaging</b>	Cardboard Type, 7" Reel

## C. Reliability Test and Judgement condition

Test items	Performance	Test condition
<b>High Temperature Exposure</b>	Appearance : No abnormal exterior appearance Capacitance Change Within ±10 % Tan δ : 0.03 max. IR : More than 10,000 MΩ or 500 MΩ × μF Whichever is smaller	Unpowered, 1,000hrs @ Max. temperature Measurement at 24±2hrs after test conclusion Initial Measurement 2* Final Measurement 3*
<b>Temperature Cycling</b>	Appearance : No abnormal exterior appearance Capacitance Change Within ±10 % Tan δ : 0.03 max. IR : More than 10,000 MΩ or 500 MΩ × μF Whichever is smaller	1,000Cycles Initial Measurement 2* Final Measurement 3* Measurement at 24±2hrs after test conclusion 1 cycle condition : -55+0/-3℃(30±3min) → Room Temp. (1min) → 125+3/-0℃(30±3min) → Room Temp. (1min)
<b>Destructive Physical Analysis</b>	No Defects or abnormalities	Per EIA 469
<b>Humidity Bias</b>	Appearance : No abnormal exterior appearance Capacitance Change Within ±12.5 % Tan δ : 0.035 max. IR : More than 500 MΩ or 25 MΩ × μF Whichever is smaller	1,000hrs 85℃/85%RH, Rated Voltage and 1.3~1.5V, Add 100kohm resistor Initial Measurement 2* Final Measurement 4* Measurement at 24±2hrs after test conclusion The charge/discharge current is less than 50mA.
<b>High Temperature Operating Life</b>	Appearance : No abnormal exterior appearance Capacitance Change Within ±12.5 % Tan δ : 0.035 max. IR : More than 1,000 MΩ or 50 MΩ × μF Whichever is smaller	1,000hrs @ 125℃, 200% Rated Voltage, Initial Measurement 2* Final Measurement 4* Measurement at 24±2hrs after test conclusion The charge/discharge current is less than 50mA.

	Performance	Test condition								
External Visual	No abnormal exterior appearance	Microscope (×10)								
Physical Dimension	Within the specified dimensions	Using The calipers								
Mechanical Shock	Appearance : No abnormal exterior appearance Capacitance Change Within ±10 % Tan δ, IR : Initial spec.	Three shocks in each direction should be applied along 3 mutually perpendicular axes of the test specimen (18 shocks) <table border="1"> <thead> <tr> <th>Peak value</th> <th>Duration</th> <th>Wave</th> <th>Velocity</th> </tr> </thead> <tbody> <tr> <td>1,500G</td> <td>0.5ms</td> <td>Half sine</td> <td>4.7m/sec</td> </tr> </tbody> </table> Initial Measurement 2* Final Measurement 5*	Peak value	Duration	Wave	Velocity	1,500G	0.5ms	Half sine	4.7m/sec
Peak value	Duration	Wave	Velocity							
1,500G	0.5ms	Half sine	4.7m/sec							
Vibration	Appearance : No abnormal exterior appearance Capacitance Change Within ±10 % Tan δ, IR : Initial spec.	5g's for 20min., 12cycles each of 3 orientations, Use 8"×5" PCB 0.031" Thick 7 secure points on one long side and 2 secure points at corners of opposite sides. Parts mounted within 2" from any secure point. Test from 10~2,000Hz. Initial Measurement 2* Final Measurement 5*								
Resistance to Solder Heat	Appearance : No abnormal exterior appearance Capacitance Change Within ±10 % Tan δ, IR : Initial spec.	preheating : 150°C for 60~120 sec. Solder pot : 260±5°C, 10±1sec. Initial Measurement 2* Final Measurement 3*								
ESD	Appearance : No abnormal exterior appearance Capacitance Change Within ±10 % Tan δ, IR : Initial spec.	AEC-Q200-002 or ISO/DIS10605 Initial Measurement 2* Final Measurement 4*								
Solderability	95% of the terminations is to be soldered evenly and continuously	a) Preheat at 155°C for 4 hours, Immerse in solder for 5s at 245±5°C b) Steam aging for 8 hours, Immerse in solder for 5s at 245±5°C c) Steam aging for 8 hours, Immerse in solder for 120s at 260±5°C solder : a solution ethanol and rosin								
Electrical Characterization	Capacitance : Within specified tolerance Tan δ : 0.025 max. IR(25°C) : More than 10,000 MΩ or 500 MΩ×μF Whichever is smaller IR(125°C) More than 1,000 MΩ or 10 MΩ×μF Whichever is smaller  Dielectric Strength	*A capacitor prior to measuring the capacitance is heat treated at 150 +0/-10°C for 1hour and maintained in ambient air for 24±2 hours The Capacitance / D.F. should be measured at 25°C, 1 kHz ± 10%, 1 ± 0.2 Vrms I.R. should be measured with a DC voltage not exceeding Rated Voltage @25°C, @125°C for 60~120 sec.  Dielectric Strength : 250% of the rated voltage for 1~5 seconds								
Board Flex	Appearance : No abnormal exterior appearance Capacitance Change Within ±10 %	Bending to the limit, 3 mm for 60 seconds 1* Initial Measurement 2* Final Measurement 5*								
Terminal Strength(SMD)	Appearance : No abnormal exterior appearance Capacitance Change Within ±10 %	10 N, for 60 sec. Initial Measurement 2* Final Measurement 5*								
Beam Load	Destruction value should be exceed 20 N	Beam speed : 0.5±0.05 mm/sec								
Temperature Characteristics	X7R From -55 °C to 125 °C, Capacitance change should be within ±15%									

#### D. Recommended Soldering method :

Reflow ( Reflow Peak Temperature : 260 +0/-5°C, 30sec. ), Meet IPC/JEDEC J-STD-020 D Standard

- \*1 : The figure indicates typical specification. Please refer to individual specifications.
- \*2 : Initial measurement : Perform a heat treatment at 150 +0/-10°C for one hour after soldering process. and then let sit for 24±2 hours at room temperature. Perform the initial measurement.
- \*3 : Final measurement : Let sit for 24±2 hours at room temperature after test conclusion, then measure.
- \*4 : Final measurement : Perform a heat treatment at 150 +0/-10°C for one hour after soldering process. and then let sit for 24±2 hours at room temperature. Perform the initial measurement.
- \*5 : Final measurement : Let measure within 24 hours at room temperature after test conclusion.

⚠ Product specifications included in the specifications are effective as of March 1, 2013.

Please be advised that they are standard product specifications for reference only.

We may change, modify or discontinue the product specifications without notice at any time.

So, you need to approve the product specifications before placing an order.

Should you have any question regarding the product specifications, please contact our sales personnel or application engineers.

## 2-2. Recommended TEST PCB

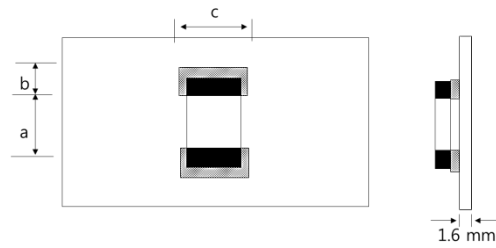

( Adhesive strength of termination)

Size code	Size (mm)	a	b	c
02	0.4 × 0.2	0.20	0.17	0.26
03	0.6 × 0.3	0.30	0.30	0.30
05	1.0 × 0.5	0.40	0.55	0.50
10	1.6 × 0.8	1.00	1.00	1.20
21	2.0 × 1.25	1.20	1.40	1.65
31	3.2 × 1.6	2.20	1.40	2.00
32	3.2 × 2.5	2.20	1.40	2.90
43	4.5 × 3.2	3.50	1.75	3.70
55	5.7 × 5.0	4.50	1.75	5.60

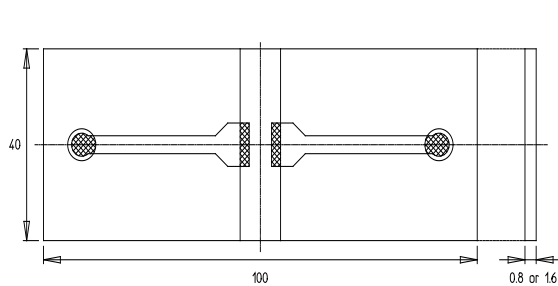

(Substrate for bending strength test)

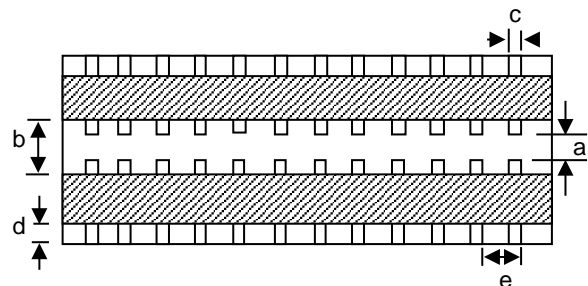

(Substrate for Reliability test)

Size code	Size (mm)	a	b	c	d	e
02	0.4 × 0.2	0.2	0.6	0.2	5.0	5.5
03	0.6 × 0.3	0.3	0.9	0.3	5.0	5.5
05	1.0 × 0.5	0.4	1.5	0.5	5.0	5.5
10	1.6 × 0.8	1.0	3.0	1.2	5.0	5.5
21	2.0 × 1.25	1.2	4.0	1.65	5.0	5.5
31	3.2 × 1.6	2.2	5.0	2.0	5.0	5.5
32	3.2 × 2.5	2.2	5.0	2.9	5.0	5.5
43	4.5 × 3.2	3.5	7.0	3.7	5.0	5.5
55	5.7 × 5.0	4.5	8.0	5.6	5.0	5.5

☞ Material : Glass epoxy substrate      ☞ Thickness : T=1.6 mm (T= 0.8 mm for 03/05)

☞ : Copper foil (T=0.035 mm)      ☞ : Solder resist

☞ Caution : Abnormality can occur if lead-based solder (KSD 6704) with 3% silver is used..

### 3. Product Characteristic data

#### 3-1. Capacitance

The capacitance is the ratio of the change in electric charge according to voltage change. Since the capacitance may change with the measured voltage and frequency. It is recommended to measure the capacitance based on the following conditions.

3-1-1. Measure capacitance with voltage and frequency specified in this document.

Regarding voltage/frequency condition to measure capacitance of each MLCC model.

Please follow section "2-1. Reliability test Condition - Capacitance" in this document.

The following table shows the voltage and frequency condition according to capacitance range.

[The voltage and frequency condition according to MLCC capacitance range]

◆ **Class I**

Capacitance	Frequency	Voltage
≤ 1,000 pF	1 MHz ± 10%	0.5 ~ 5 Vrms
> 1,000 pF	1 kHz ± 10%	

◆ **Class II**

Capacitance	Frequency	Voltage
≤ 10 μF	1 kHz ± 10%	1.0 ± 0.2 Vrms
> 10 μF	120 Hz ± 20%	0.5 ± 0.1 Vrms
Exception*	1 kHz ± 10%	0.5 ± 0.1 Vrms

Capacitance shall be measured after the heat treatment of 150+0/-10°C for 1hr and leaving for 24±2hr at room temperature. (Class II)

3-1-2. It is recommended to use measurement equipment with ALC (Auto Level Control) option.

The reason is that when capacitance or measurement frequency is high, the measurement equipment's output voltage can be lower than the setting voltage due to the limit of the equipment. Note that when capacitance or measurement frequency is excessively high, the measurement equipment may show ALC off warning and provide lower output voltage than the setting voltage even with ALC option selected. It is necessary to ensure measurement equipment's output voltage is the same as the setting voltage before measuring capacitance.

3-1-3. Capacitance value of high dielectric constant (Class II) MLCC changes with applied AC and DC voltage. Therefore, it is necessary to take into account MLCC's AC voltage characteristics and DC-bias voltage characteristics when applying MLCC to the actual circuit.

3-1-4. The capacitance is in compliance with the EIA RS-198-1-F-2002.

### 3-2. Tan $\delta$ (DF)

3-2-1. An ideal MLCC's energy loss is zero, but real MLCC has dielectric loss and resistance loss of electrode. DF (Dissipation Factor) is defined as the ratio of loss energy to stored energy and normally expressed in percentage.

3-2-2. Quality factor (Q factor) is defined as the ratio of stored energy to loss energy. The equation can be described as  $1/DF$ . Normally the loss characteristic of Class I MLCC is expressed in Q since the DF value is so small whereas the loss characteristic of Class II MLCC is expressed in DF.

3-2-3. It is recommended to use Class I MLCC for applications where good linearity and low loss are required, such as coupling circuit, filter circuit and time constant circuit.

### 3-3. Insulation Resistance

Ceramic dielectric has low leakage current with DC voltage because of the high insulating properties. Insulation resistance is defined as the ratio of leakage current to DC voltage.

3-3-1. When applying DC voltage to MLCC, charging current and leakage current flow together at the initial stage of measurement.

Charging current decreases and insulation resistance (IR) in MLCC saturates with time.

Therefore, insulation resistance shall be measured one minute after applying the rated voltage.

### 3-4. Capacitance Aging

The aging characteristic is that the high dielectric product (Class II) MLCC decreases in capacitance value over time. It is also required to consider the aging characteristics with voltage and temperature characteristic in case Class II MLCC is used for circuit that the allowed capacitance tolerance is narrow.

3-4-1. Normally, capacitance tends to decrease linearly according to the log of time as shown in the following graph.

Please check with SEMCO for more details since the value may vary between different models.

3-4-2. After heat treatment (150 °C, 1hour), the capacitance decreased by aging is recovered, so aging should be considered again from the time of heat treatment.

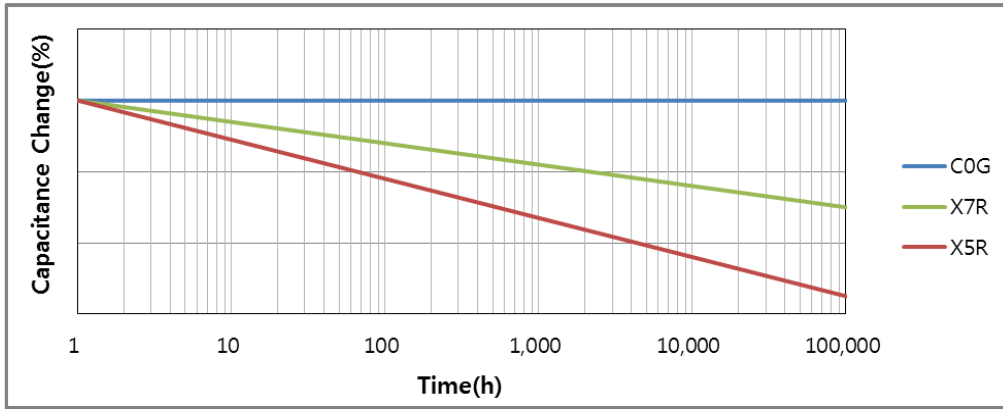

[ Example of Capacitance Aging ]

\* Sample : COG, X7R, X5R

### 3-5. Temperature Characteristics of Capacitance (TCC)

Please consider temperature characteristics of capacitance since the electrical characteristics such as capacitance changes as the ceramic dielectric constant varies with temperature.

3-5-1. It is necessary to check the values specified in section "2-1. Reliability test Condition – Temperature Characteristics" for temperature and capacitance change range of MLCC.

3-5-2. When selecting MLCC, it is necessary to consider the heat characteristics of your system, ambient temperature and TCC of MLCC since the capacitance of MLCC can change based on the applied temperature.

3-5-3. It is also required to consider Bias TCC of MLCC when DC voltage is applied to MLCC.

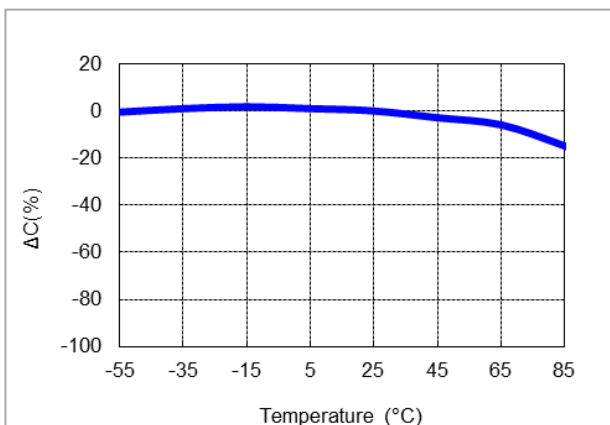

[ Example of Temperature Characteristics (X5R) ]

\* Sample : 10uF, Rated voltage 6.3V

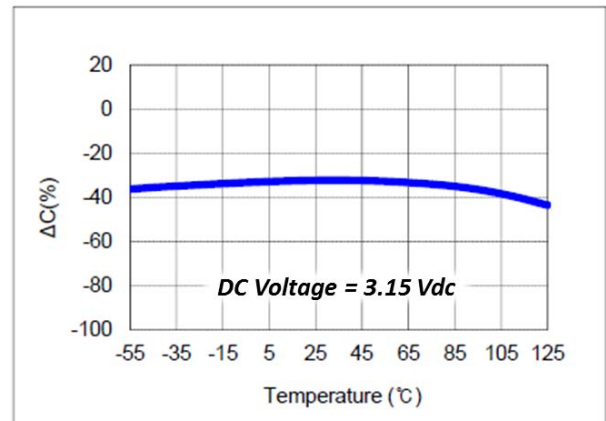

[ Example of Bias TCC ]

\* Sample : 10uF, Rated voltage 6.3V

### 3-6. Self-heating Temperature

It is necessary to design the system considering self-heating generated due to the ESR (Equivalent Series Resistance) of MLCC when AC voltage or pulse voltage is applied to MLCC.

3-6-1. When MLCC is used in an AC voltage or pulse voltage circuit, self-heating is generated when AC or pulse current flows through MLCC. Short-circuit may occur due to the degradation of MLCC's insulating properties.

3-6-2. When MLCC is used in an AC voltage or pulse voltage circuit, the following conditions shall be followed since the reliability of MLCC may be affected even when AC voltage or pulse voltage is within the range of rated voltage.

- 1) The surface temperature of MLCC must stay within the maximum operating temperature after AC or Pulse voltage is applied.
- 2) The temperature increase by self-heating of MLCC shall not exceed more than 20°C.

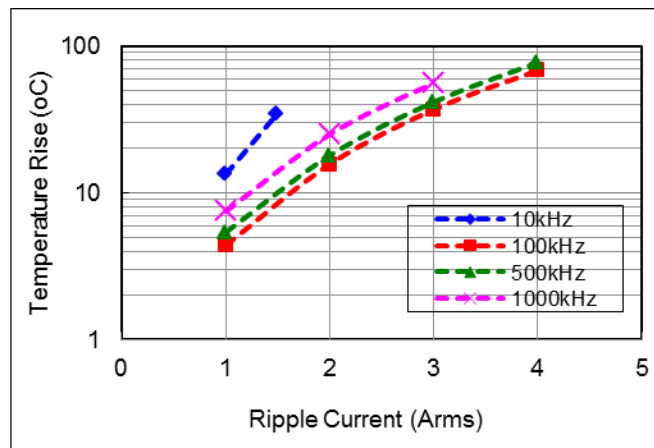

[ Example of Ripple current ]

\* Sample : X5R 10uF, Rated voltage 6.3V

### 3-7. DC & AC Voltage Characteristics

It is required to consider voltage characteristics in the circuit since the capacitance value of high dielectric constant MLCC(Class II) is changed by applied DC & AC voltage.

3-7-1. Please ensure the capacitance change is within your system's allowable operating range.

When high dielectric constant type MLCC (Class II) is used in circuit where allowable capacitance tolerance is narrow, consider DC voltage, temperature characteristics and aging characteristics.

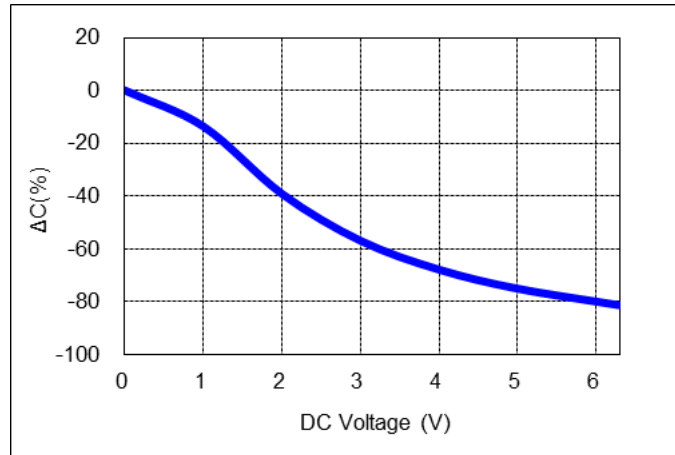

[ Example of DC Bias characteristics ]

\* Sample : X5R 10uF, Rated voltage 6.3V

3-7-2. It is necessary to consider the AC voltage characteristics of MLCC and the AC voltage of your system since the capacitance value of high dielectric constant type MLCC (Class II) varies with the applied AC voltage.

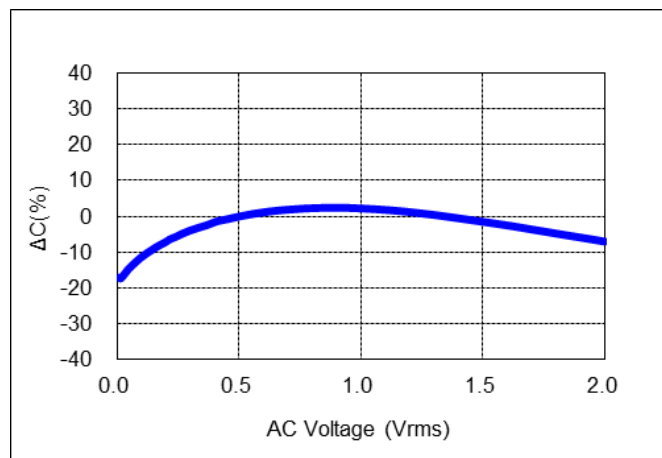

[ Example of AC voltage characteristics ]

\* Sample : X5R 10uF, Rated voltage 6.3V

### 3-8 Impedance Characteristic

Electrical impedance ( $Z$ ) of MLCC is the measure of the opposition that MLCC presents to a current ( $I$ ) when a voltage ( $V$ ) is applied. It is defined as the ratio of the voltage to the current ( $Z=V/I$ ). Impedance extends the concept of resistance to AC circuits, which is a complex number consisting of the real part of resistance ( $R$ ) and the imaginary part of reactance ( $X$ ) as  $Z=R+jX$ . Therefore, it is required to design a circuit considering the impedance characteristics of MLCC according to the frequency.



3-8-1. MLCC operates as a capacitor in the low frequency and its reactance (XC) decreases as frequency increases ( $X_C=1/j2\pi fC$ ) where f is frequency and C is capacitance.

The resistance (ESR; Equivalent Series Resistance) of MLCC in the low frequency mainly comes from the loss of its dielectric material.

3-8-2. MLCC operates as an inductor in the high frequency and the inductance of MLCC is called ESL (Equivalent Series Inductance). The reactance (XL) of MLCC in the high frequency increases as frequency increases ( $X_L=j2\pi f \cdot ESL$ ). The resistance (ESR) of MLCC in the high frequency mainly comes from the loss of its electrode metal.

3-8-3. SRF (Self Resonant Frequency) of MLCC is the frequency where its capacitive reactance (XC) and inductive reactance (XL) cancel each other and the impedance of MLCC has only ESR at SRF.

3-8-4. The impedance of MLCC can be measured by using a network analyzer or an impedance analyzer. In case of the network analyzer, it should be considered that the input source for measurement is small signal, which can lead to the impedance of low capacitance due to AC voltage characteristic of MLCC.

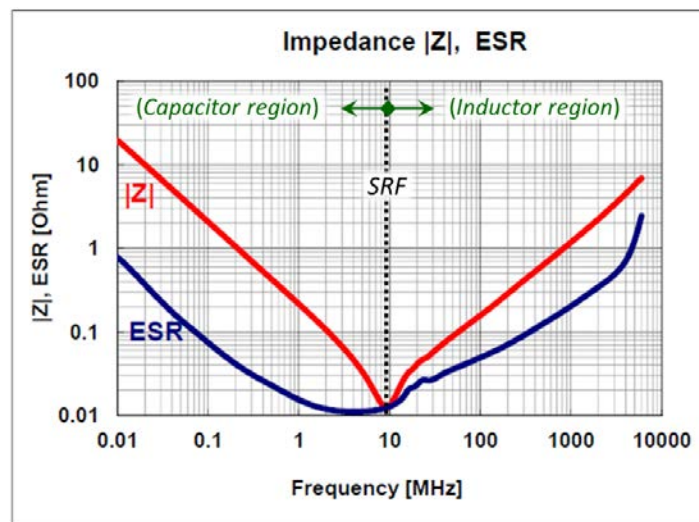

[ Example of Impedance characteristics ]

\* Sample : X5R 1uF, Rated voltage 6.3V

\* Contact SEMCO web site and check TCC, DC-Bias, Impedance characteristics if necessary.

## 4. Packaging

This specification applies to taping of MLCC

It can be possible to change the specification under document agreement between design engineers of each party.

4-1. Figure

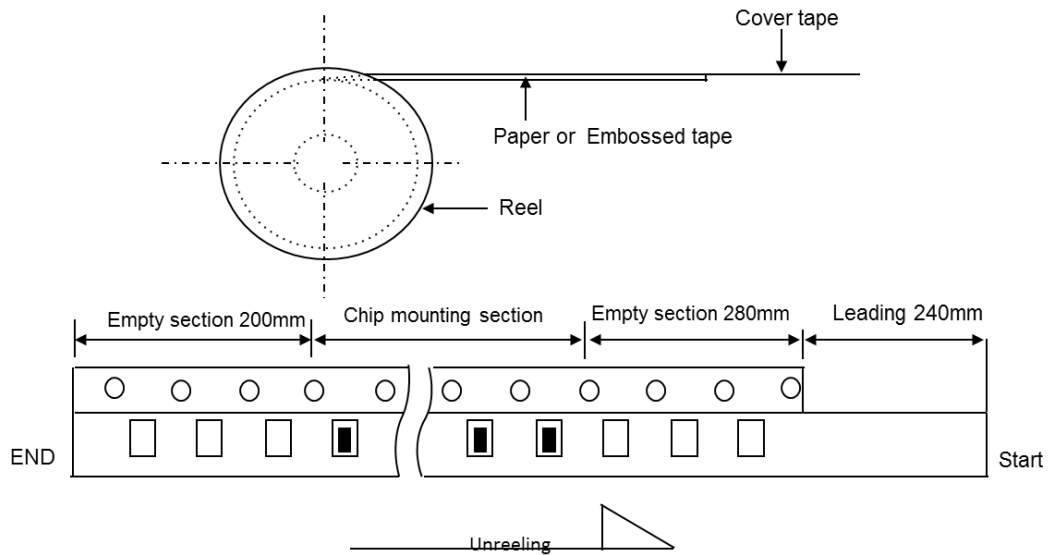

4-2. Quantity

[unit:pcs]

	Size Code Inch(mm)	Chip T	Taping type	Pitch	Plastic 7 inches reel	Plastic 10 inches reel	Plastic 13 inches reel
MLCC	0402 (01005)	0.2 mm	PAPER	2mm	20k	-	100K
	0603 (0201)	0.3 mm	PAPER	2mm	10K	-	50K
	1005 (0402)	0.5 mm	PAPER	2mm	10K	-	50K
	1608 (0603)	0.8 mm	PAPER	4mm	4K	10K	15K / 10K
	2012 (0805)	$T \leq 0.85$ mm	PAPER	4mm	4K	10K	15K / 10K
		$T \geq 1.0$ mm	EMBOSSSED	4mm	2K	6K	10K
	3216 (1206)	$T \leq 0.85$ mm	PAPER	4mm	4K	10K	10K
		$T \geq 1.0$ mm	EMBOSSSED	4mm	2K	4K	10K
	3225 (1210)	$T \leq 1.6$ mm	EMBOSSSED	4mm	2K	4K	10K
		$T \geq 2.0$ mm	EMBOSSSED	4mm	1K	4K	4K
	4520 (1808)	$T \leq 1.6$ mm	EMBOSSSED	8mm	2k	-	8k
		$T \geq 2.0$ mm	EMBOSSSED	8mm	1k	-	4k
	4532 (1812)	$T \leq 2.0$ mm	EMBOSSSED	8mm	-	-	4K
$T > 2.0$ mm		EMBOSSSED	8mm	-	-	2K	
5750 (2220)	$T \geq 2.5$ mm	EMBOSSSED	8mm	-	-	2K	

### 4-3. Tape Size

#### 4-3-1. Cardboard(Paper) tape : 4mm pitch

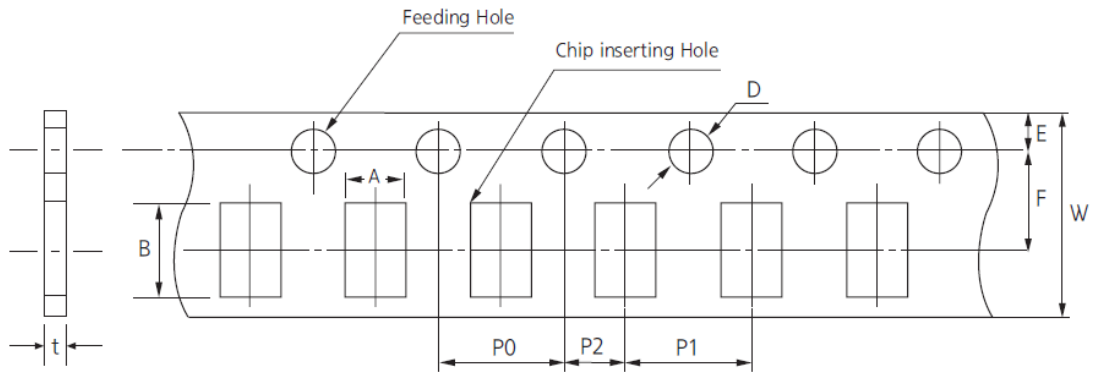

[unit:mm]

Size Inch(mm)	A	B	W	F	E	P1	P2	P0	D	t
<b>0603</b> <b>(1608)</b>	1.00 ±0.10	1.90 ±0.10	8.00 ±0.30	3.50 ±0.05	1.75 ±0.10	4.00 ±0.10	2.00 ±0.05	4.00 ±0.10	φ1.50 +0.10/-0	1.1 Below
<b>0805</b> <b>(2012)</b>	1.55 ±0.10	2.30 ±0.10								
<b>1206</b> <b>(3216)</b>	2.05 ±0.10	3.60 ±0.10								

※ According to normal size, we fill out A, B in the table above. The data may be changed as special size tolerance.

#### 4-3-2. Cardboard(Paper) tape : 2mm pitch

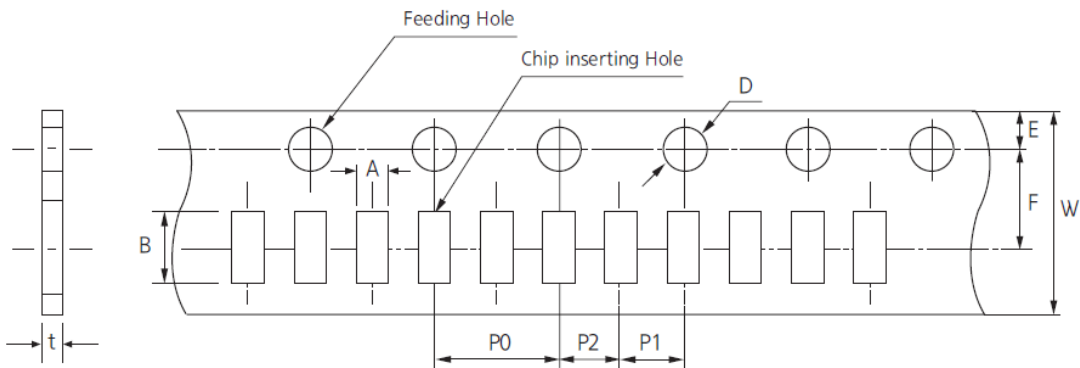

[unit:mm]

Size Inch(mm)	A	B	W	F	E	P1	P2	P0	D	t
<b>01005</b> <b>(0402)</b>	0.25 ±0.02	0.46 ±0.02	8.00 ±0.30	3.50 ±0.05	1.75 ±0.10	2.00 ±0.05	2.00 ±0.05	4.00 ±0.10	φ1.50 +0.10 /-0.03	0.25 ±0.02
<b>0201</b> <b>(0603)</b>	0.38 ±0.03	0.68 ±0.03								0.35 ±0.03
<b>0402</b> <b>(1005)</b>	0.62 ±0.05	1.12 ±0.05								0.60 ±0.05
<b>0204</b> <b>(0510)</b>	0.62 +0.05 /-0.10	1.12 +0.05 /-0.10								0.37 ±0.03

※ According to normal size, we fill out A, B in the table above. The data may be changed as special size tolerance.

4-3-3. Embossed(Plastic) tape

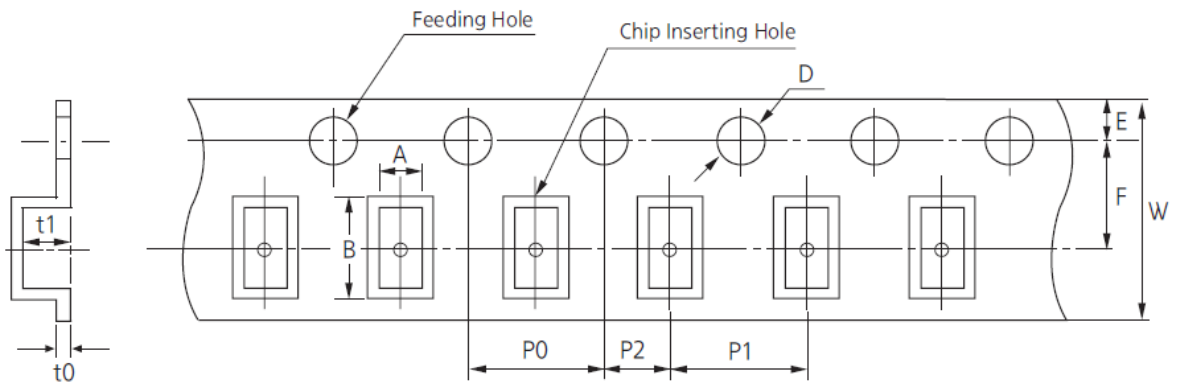

[unit:mm]

Size Inch(mm)	A	B	W	F	E	P1	P2	P0	D	t1	t0			
<b>01005</b> <b>(0402)</b>	0.23 $\pm 0.02$	0.45 $\pm 0.02$	4.00 $\pm 0.05$	1.80 $\pm 0.02$	0.90 $\pm 0.05$	1.00 $\pm 0.02$	1.00 $\pm 0.02$	2.00 $\pm 0.03$	$\phi 0.80$ $\pm 0.04$	0.35 Below	0.50 Below			
<b>015008</b> <b>(05025)</b>	0.32 $\pm 0.03$	0.58 $\pm 0.03$	8.00 $\pm 0.30$	3.50 $\pm 0.05$	1.75 $\pm 0.10$	2.00 $\pm 0.05$	2.00 $\pm 0.05$	4.00 $\pm 0.10$	$\phi 1.50$ $+0.10$ $-0.03$					
<b>0603</b> <b>(1608)</b>	1.05 $\pm 0.15$	1.90 $\pm 0.15$				12.0 $\pm 0.30$			5.60 $\pm 0.05$	8.00 $\pm 0.10$	2.00 $\pm 0.05$	4.00 $\pm 0.10$	$\phi 1.50$ $+0.10$ $-0$	2.50 Below
<b>0805</b> <b>(2012)</b>	1.45 $\pm 0.20$	2.30 $\pm 0.20$												3.80 Below
<b>1206</b> <b>(3216)</b>	1.90 $\pm 0.20$	3.50 $\pm 0.20$												
<b>1210</b> <b>(3225)</b>	2.80 $\pm 0.20$	3.60 $\pm 0.20$				8.00 $\pm 0.30$			3.50 $\pm 0.05$	4.00 $\pm 0.10$	2.00 $\pm 0.05$	4.00 $\pm 0.10$	$\phi 1.50$ $+0.10$ $-0$	0.60 Below
<b>1808</b> <b>(4520)</b>	2.30 $\pm 0.20$	4.90 $\pm 0.20$	2.50 Below											
<b>1812</b> <b>(4532)</b>	3.60 $\pm 0.20$	4.90 $\pm 0.20$		8.00 $\pm 0.30$	3.50 $\pm 0.05$	4.00 $\pm 0.10$	2.00 $\pm 0.05$	4.00 $\pm 0.10$	$\phi 1.50$ $+0.10$ $-0$					
<b>2220</b> <b>(5750)</b>	5.50 $\pm 0.20$	6.20 $\pm 0.20$	2.50 Below											
<b>0204</b> <b>(0510)</b>	0.62 $+0.05$ $-0.10$	1.12 $+0.05$ $-0.10$		8.00 $\pm 0.30$	3.50 $\pm 0.05$	4.00 $\pm 0.10$	2.00 $\pm 0.05$	4.00 $\pm 0.10$	$\phi 1.50$ $+0.10$ $-0$					
<b>0306</b> <b>(0816)</b>	1.10 $\pm 0.20$	1.90 $\pm 0.20$												

※ According to normal size, we fill out A, B in the table above. The data may be changed as special size tolerance.

4-3-4. Reel Size

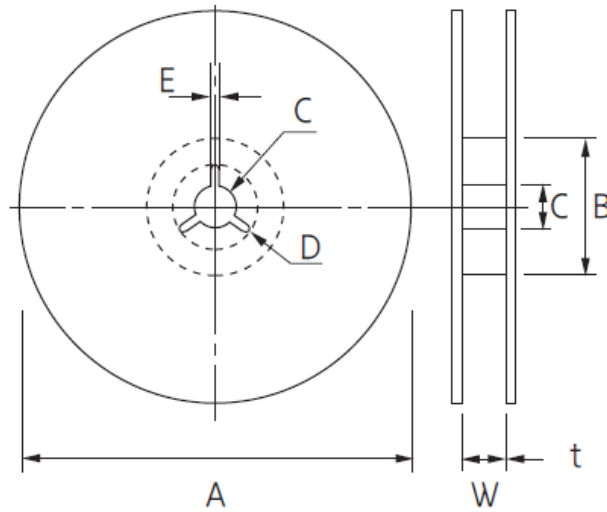

[unit:mm]

Symbol	Tape Width	A	B	C	D	E	W	t
7"Reel	4mm	$\phi 178 \pm 2.0$	MIN $\phi 50$	$\phi 13 \pm 0.5$	$21 \pm 0.8$	$2.0 \pm 0.5$	$5 \pm 0.5$	$1.2 \pm 0.2$
	8mm	$\phi 178 \pm 2.0$	MIN $\phi 50$	$\phi 13 \pm 0.5$	$21 \pm 0.8$	$2.0 \pm 0.5$	$10 \pm 1.5$	$0.9 \pm 0.2$
	12mm	$\phi 178 \pm 2.0$	MIN $\phi 50$	$\phi 13 \pm 0.5$	$21 \pm 0.8$	$2.0 \pm 0.5$	$13 \pm 0.5$	$1.2 \pm 0.2$
10"Reel	8mm	$\phi 258 \pm 2.0$	MIN $\phi 70$	$\phi 13 \pm 0.5$	$21 \pm 0.8$	$2.0 \pm 0.5$	$10 \pm 1.5$	$1.8 \pm 0.2$
13"Reel	8mm	$\phi 330 \pm 2.0$	MIN $\phi 70$	$\phi 13 \pm 0.5$	$21 \pm 0.8$	$2.0 \pm 0.5$	$10 \pm 1.5$	$1.8 \pm 0.2$
	12mm	$\phi 330 \pm 2.0$	MIN $\phi 70$	$\phi 13 \pm 0.5$	$21 \pm 0.8$	$2.0 \pm 0.5$	$13 \pm 0.5$	$2.2 \pm 0.2$

4-4. Cover tape peel-off force

4-4-1. Peel-off force

10 g.f  $\leq$  peel-off force  $\leq$  70 g.f

4-4-2. Measuring method

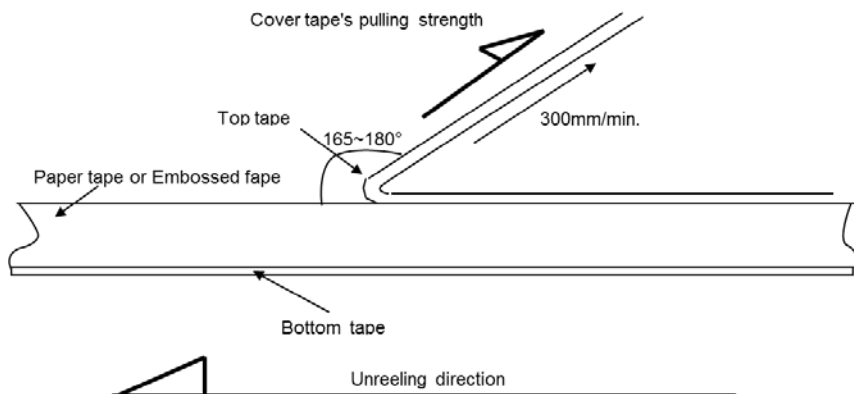

-Taping Packaging design : Packaging design follows IEC 60286-3 standard.  
 (IEC 60286-3 Packaging of components for automatic handling - parts 3)

\* In case of problem due to static electricity of SMT process, contact us.

## 4-5. BOX package

### 4-5-1. Packaging Label

REEL & Box Type

Label contains below information.

- 1) Chip size
- 2) Temperature Characteristics
- 3) Nominal Capacitance
- 4) Model name
- 5) LOT Number & Reel Number
- 6) Q'ty

### 4-5-2. Box Packaging

- 1) Double packaging with paper type inner box and outer box.
  - 2) Avoid any damage during transportation by car, airplane and ship.
  - 3) Remark information of contents on inner box and outer box
- ※ In case special packaging is required, contact us.

### 4-5-3. 7" Box packaging

[ Unit : mm ]

- Inner Box (7" x 5 REEL )

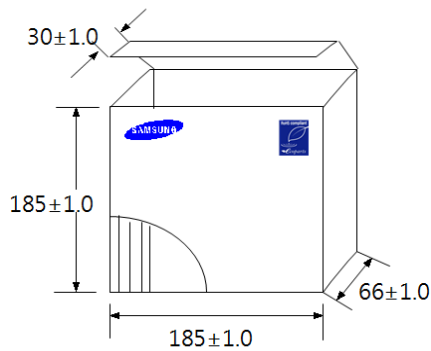

- Inner Box (7" x 10 REEL)

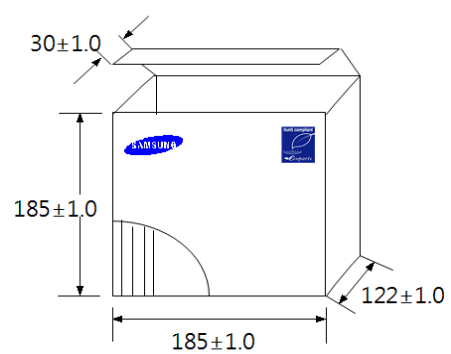

- Out Box (7" x 20 REEL)

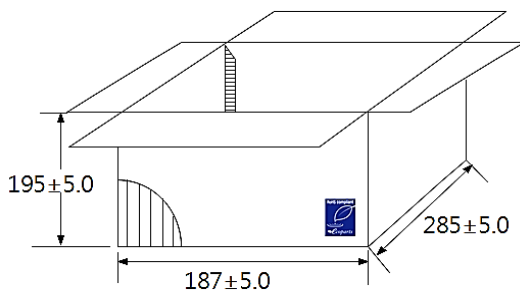

- Out Box (7" x 60 REEL)

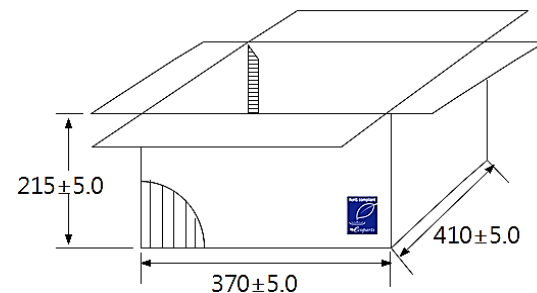

#### 4-5-4. 13" Box packaging

- Inner Box (13" x 4 REEL)

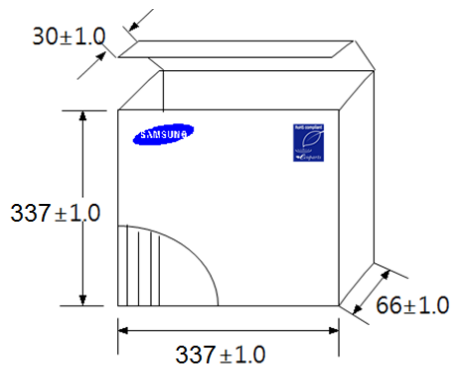

- Out Box (13" x 20 REEL)

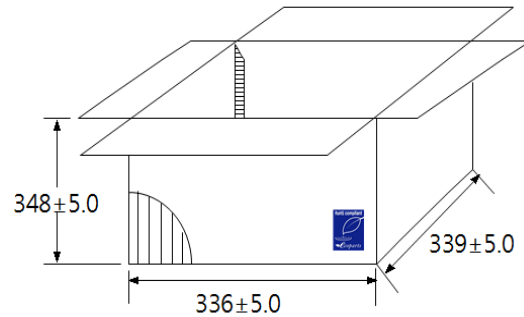

#### 4-6. Chip Weight

Size(L/W) Inch(mm)	Size(T) (mm)	Thickness Code	Temp	Weight (mg/pc)
<b>0402</b> <b>(1005)</b>	0.50	5	X7*	1.606
	0.60	6	X7*	3.288
	0.50	5	C0G	1.181
<b>0603</b> <b>(1608)</b>	0.80	8	X7*	6.492
	0.80	8	C0G	4.600
<b>0805</b> <b>(2012)</b>	0.60	6	X7*	8.670
	0.85	C	X7*	13.338
	1.25	F	X7*	19.526
	1.25	Q	X7*	23.200
	0.60	6	C0G	8.253
	0.85	C	C0G	9.827
<b>1206</b> <b>(3216)</b>	1.25	F	C0G	16.737
	1.15	P	X7*	35.860
	1.60	H	X7*	55.045
<b>1210</b> <b>(3225)</b>	1.60	K	X7*	55.045
	2.00	I	X7*	111.670
	2.50	J	X7*	142.335
	2.50	V	X7*	195.049

Product weight is typical value per size, contact us if necessary.

## 5. Electrical & Mechanical caution

### 5-1. Derating

For the derated MLCC of which the test voltage is 100% of the rated voltage in the high temperature resistance test, it is recommended that voltage and temperature applied continuously to MLCC should be derated as in the following graph for the equivalent life time to the normal MLCC with 150% test voltage of the rated voltage in the high temperature resistance test.

5-1-1. It is recommended that the derated MLCC should be applied in the condition below derating voltage and temperature as shown in the following graph.

5-1-2. Temperature of x-axis in the graph below means the surface temperature of MLCC including self-heating of MLCC and operating maximum voltage in "Voltage Derating Ratio" of y-axis refers to the maximum voltage (Vmax) in "5-2. Applied Voltage".

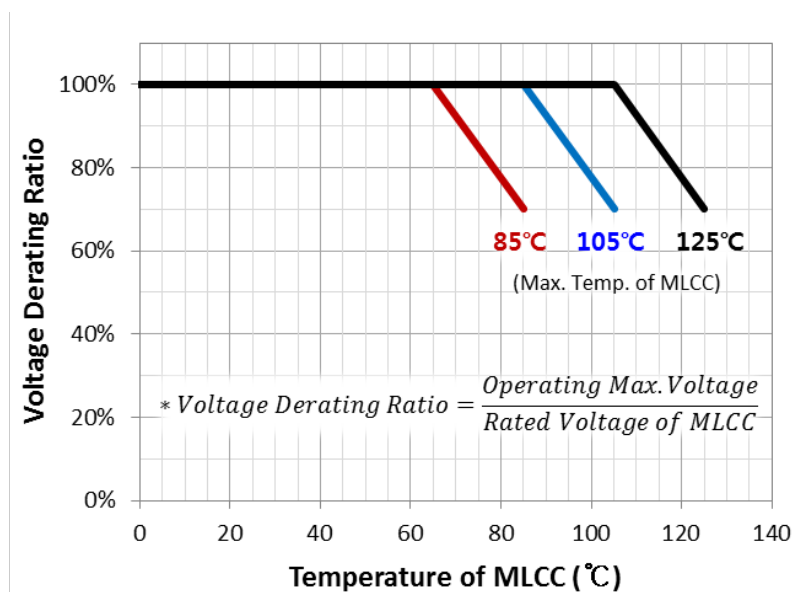

[ Example of derating graph for derated MLCC ]

\*  $V_{max} \leq \text{Derated Voltage}$

\* Only the Derating marked models

### 5-2. Applied Voltage

It is recommended that MLCC should be not used in voltage condition higher than the rated voltage of MLCC described in the specifications.



5-2-1. Cautions according to type of voltage applied to MLCC

- In case of DC voltage or DC+AC voltage, DC voltage or the maximum voltage of DC + AC voltage should not exceed the rated voltage of MLCC.
- In case of AC voltage or pulse voltage, the peak-to-peak voltage of AC voltage or pulse voltage should not exceed the rated voltage of MLCC.
- Abnormal voltage such as surge voltage, static electricity should not exceed the rated voltage of MLCC.

[ Types of voltage applied to the capacitor ]

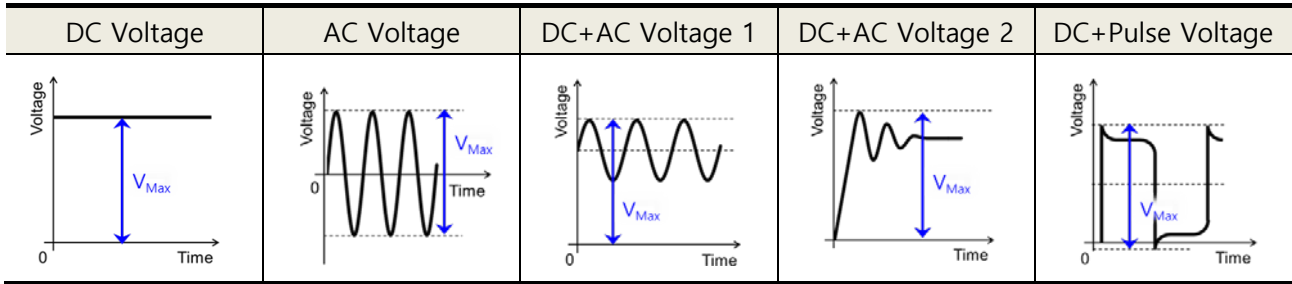

5-2-2. Effect of EOS (Electrical Overstress)

- In case the electrical overstress such as surge is applied to MLCC, it can cause damage to MLCC and result in the electrical short failure caused by the dielectric breakdown in MLCC.
- Time duration from the damage caused by EOS to the breakdown failure of MLCC depends on the applied voltage and the ambient temperature.
- It is recommended to be careful not to apply the excessive electrical overstress to MLCC during the treatment of MLCC for testing or evaluating.

(1) Surge

In case the overcurrent caused by surge is applied to MLCC, the influx of current into MLCC can induce the overshooting phenomenon of voltage as shown in the graph below and result in the electrical short failure in MLCC. Accordingly, it is necessary to be careful to prevent the influx of surge current to MLCC.

Setting value 보다 높은 Surge 가 발생할 우려가 있음

(2) ESD (Electrostatic Discharge)

A buildup of static electricity caused by the friction of human body or equipment can discharge into MLCC, leading to the dielectric breakdown in MLCC.

Since the voltage of the static electricity is very high but it has small quantity of electric charge compared to the surge, ESD can cause damage to MLCC with low capacitance as in the following graph, whereas surge with lots of electric charge quantity can cause damage to even high capacitance MLCC.

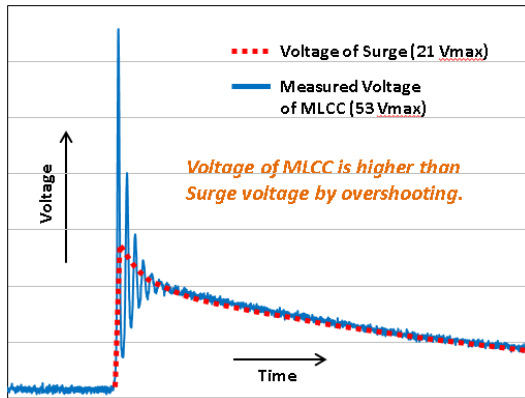

[ Example of Surge applied to MLCC ]

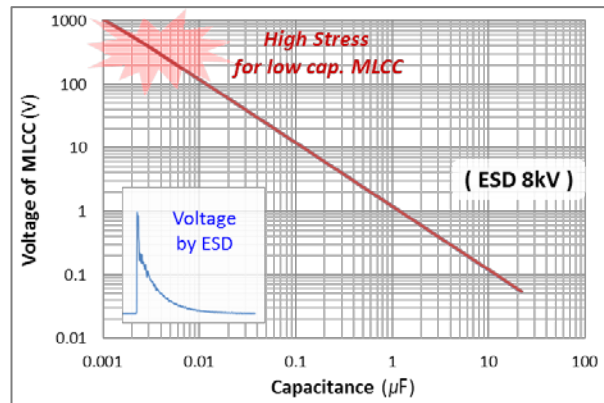

[ Example of ESD applied to MLCC ]

\* Simulation for ESD 8kV

### 5-3. Vibration

It is required to check vibration, type of shock and generation of resonance.

Mount MLCC not to generate resonance and avoid any kind of impact to terminals. In case of environment under vibration condition, consider to use special MLCC such as Soft-term, etc.

### 5-4. Shock

Mechanical stress caused by dropping may cause damages to MLCC dielectric or lead to crack.

Do not use a dropped MLCC to avoid any quality and reliability deterioration.

When piling up or handling printed circuit boards, do not hit MLCC with the corners of a printed circuit board to prevent the cracks or any other damages to the MLCC.

### 5-5. Piezo-electric Phenomenon

MLCC may generate noise due to vibration at specific frequency when using the high dielectric constant MLCC (Class II) at AC or Pulse circuits.

MLCC may also generate noise if any mechanical shock or vibration is applied to MLCC.

It is recommended to use low acoustic noise MLCC such as T-HMC, etc in order to reduce acoustic noise.

## 6. Process of Mounting and Soldering

### 6-1. Mounting

#### 6-1-1. Mounting position

It is recommended to locate the major axis of MLCC in parallel to the direction in which the stress is applied.

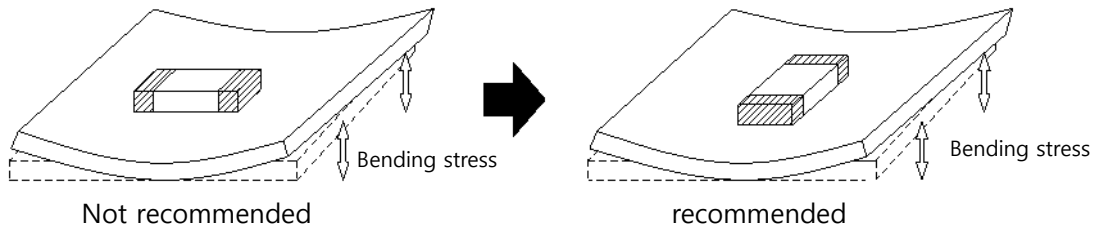

#### 6-1-2. Cautions during mounting near the cutout

It is effective to take following measures to reduce the stress during cutting printed circuit board. Select mounting location referring to the following picture since the mechanical stress depends on location and direction of MLCC mounted near the cutting line.

If you are too close to the PCB outline line or cutting line, it is weak for the bending crack.

It is dangerous if it is perpendicular to the cutting line. The risk decreases if it is horizontal on the cutting line.

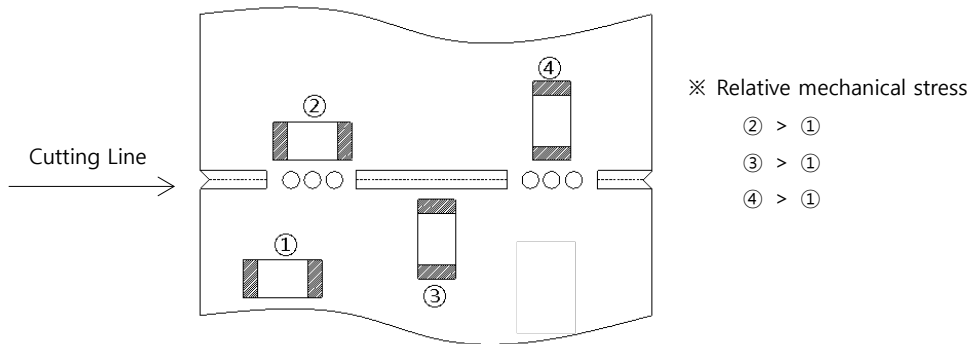

#### 6-1-3. Cautions during mounting near screw

If MLCC is mounted near a screw hole, it may be affected by the board deflection due to screw torque.

Mount MLCC in a position as far away from the screw hole as possible.

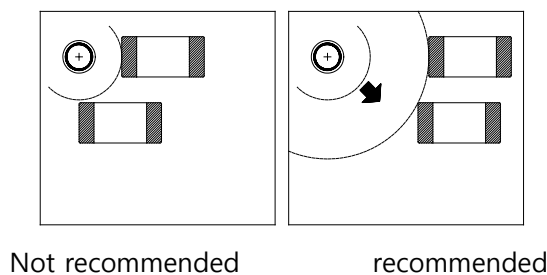

## 6-2. Caution before Mounting

- 6-2-1. MLCC is recommended to store and use in a reel and do not re-use MLCC that was isolated from the reel.
- 6-2-2. Check the capacitance characteristics under actual applied voltage.
- 6-2-3. Check the mechanical stress when actual process and equipment is in use.
- 6-2-4. Check the rated capacitance, rated voltage and other electrical characteristics before assembly.  
Heat treatment must be done prior to measurement of capacitance.
- 6-2-5. Check the solderability of MLCC that has passed shelf life before use.
- 6-2-6. The use of Sn-Zn based solder may deteriorate the reliability of MLCC.

## 6-3. Maintenance of mounting (pick-and-place) machines

### 6-3-1. Mounting Head Pressure

Excessive pressure may cause the crack of MLCC.

It is recommended to adjust the nozzle pressure within maximum 300g.f.

Additional management criteria is necessary for both thin film and special purpose MLCC.

### 6-3-2. Bending Stress

In case of two-sided substrate, it is required to first mounted on one side, and then back side mounted due to the substrate by the mounting head.

Support the substrate as shown when MLCC is mounted on the opposite side.

If the substrate is not supported, bending of the substrate may cause crack of MLCC

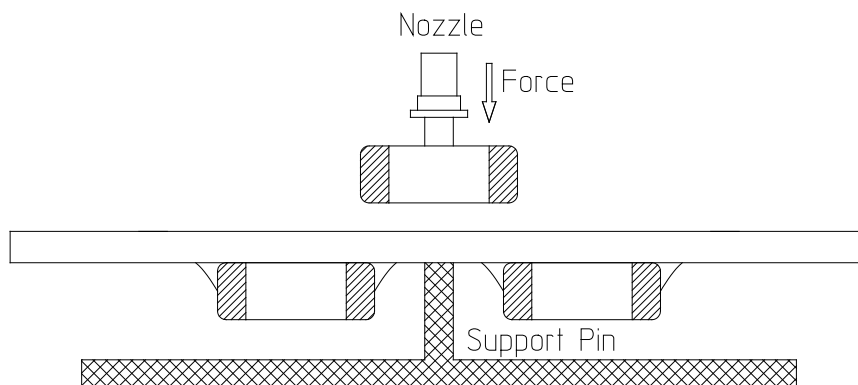

### 6-3-3. Suction nozzle

Dust accumulated in the suction nozzle and suction mechanism can impact on the smooth movement of nozzle. This may cause the crack of MLCC due to excessive force during mounting. If the mounting claw is worn out, this may cause the crack of MLCC due to uneven force during positioning.

The suction nozzle and mounting claw must be maintained, monitored and replaced periodically.

## 6-4. Reflow soldering

Since MLCC contacts directly solder dissolved during soldering, it will be exposed to potential mechanical stress due to sudden temperature change.

Accordingly, MLCC can be an object of contamination due to location movement and flux. The mounting technology is so important for these reasons.

Method		Classification
Reflow soldering	Overall heating	Infrared rays Hot plate VPS(Vapor phase)
	Local heating	Air heater Laser Light beam

### 6-4-1. Reflow Profile

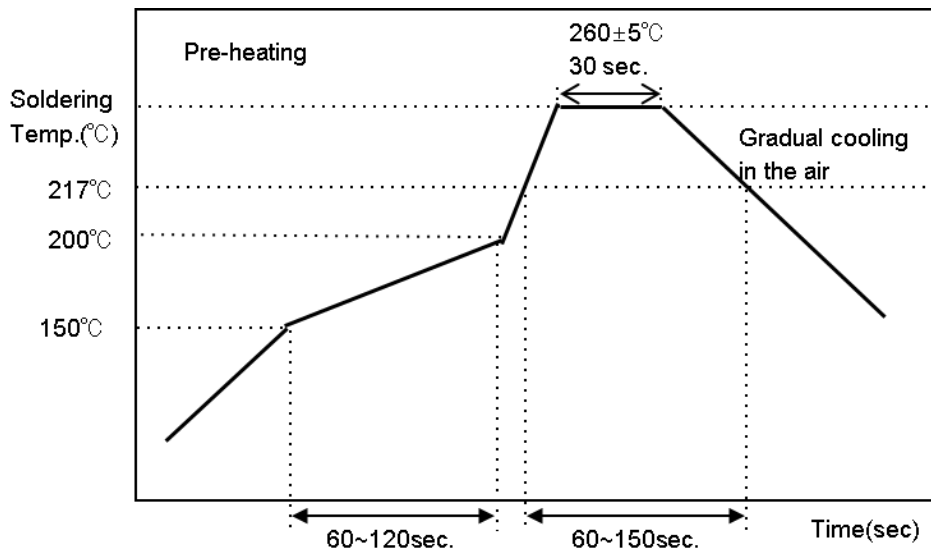

[Reflow Soldering Conditions]

Take caution not to exceed peak temperature(260°C) and time(30sec) as shown. Preheating is necessary for all the constituents including printed circuit board to prevent from mechanical damage of MLCC. It is required to keep the temperature differential between printed circuit board and the component surface as small as possible. In case of reflow soldering, it is recommended to conduct below three times and in case it exceeds three times contact us. Especially for ultra-small size, thin film and high capacitance MLCC, be careful as MLCC may be affected by thermal stress.

#### 6-4-2. Reflow temperature

The following quality problem may occur when MLCC is mounted in a lower temperature than reflow temperature recommended by a solder manufacturer. The peak temperature specified must be kept considering factors such as placement of peripheral constituent and reflow temperature.

- Drop in solder wettability
- Solder voids
- Potential occurrence of whisker
- Drop in adhesive strength
- Drop in self-alignment properties
- Potential occurrence of tombstones

#### 6-4-3. Cooling

It is recommended to natural cooling using air.

#### 6-4-4. Optimum solder flux for reflow soldering

- Overly thick application of solder paste results in an excessive solder fillet height which make MLCC more susceptible to mechanical and thermal stress of the board causing MLCC to crack.
- Too little solder paste results in a lack of adhesive strength, which may cause MLCC isolating from PCB.
- Check if solder has been applied uniformly after the completion of soldering.

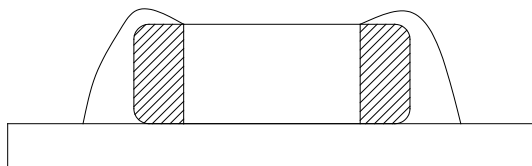

Too Much Solder

Cracks tend to occur due to large stress.

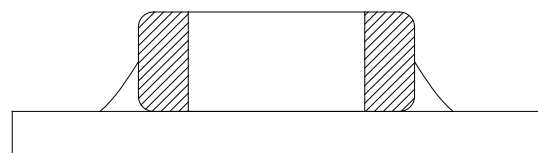

Not enough Solder

Weak holding force may cause band connections or detaching of the capacitor

- When designing printed circuit board, take land pattern and size into consideration to apply appropriate amount of solder to MLCC. The solder amount of edge will impact directly to the possible crack of MLCC.
- The design of suitable solder land is necessary since the more the solder amount is, the larger the force of MLCC is and the higher the possible crack of MLCC is.

## 6-5. Flow soldering

### 6-5-1. Flow profile

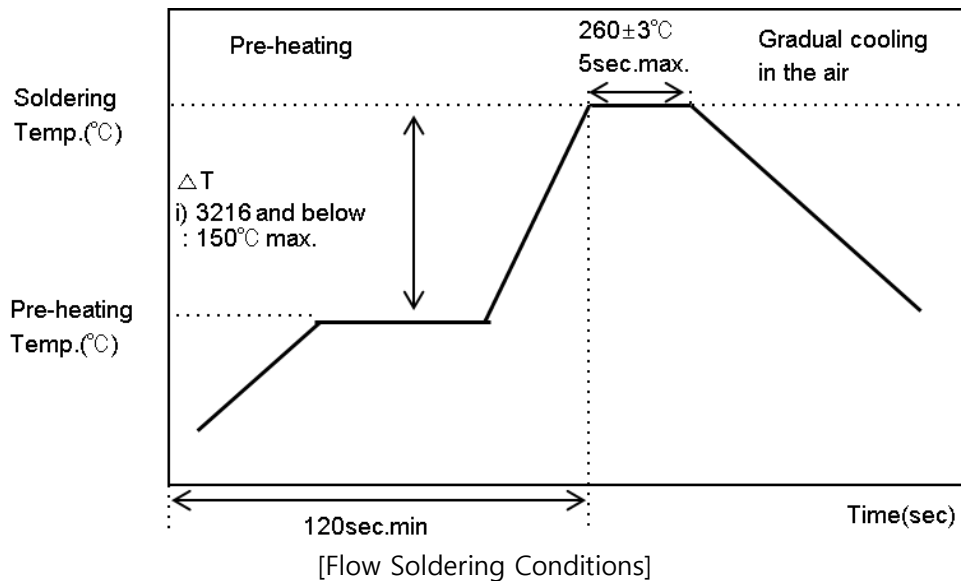

Take caution not to exceed peak temperature ( $260^{\circ}\text{C}$ ) and time (5sec) as shown.

In case of flow soldering, only 1608(0603inch), 2012(0805inch), 3216(1206inch) case size are recommended to use.

High capacitance and thin film MLCC prior to use contact us since there might be some exceptions.

### 6-5-2. Caution before Flow soldering

- If the sudden heat is applied to MLCC, the mechanical force of MLCC is deteriorated due to the internal deformation of MLCC. Preheating for all the constituents including PCB is required in order to prevent from the mechanical damage of MLCC.  
It is required keep the temperature differential between the solder and the surface of MLCC as small as possible.
- If the flow time is too long or the flow temperature is too high, it can deteriorate the adhesive strength with PCB due to the leaching phenomenon of the outer termination or the capacitance value may be dropped due to the drop in the adhesiveness between the internal termination and the outer termination.

## 6-6. Soldering Iron

Manual soldering has high possibility to cause the thermal crack to MLCC. In case of high temperature soldering, solder tip may directly contact the ceramic body of MLCC due to the carelessness of the worker.

Accordingly, manual soldering is carefully treated and the special care is required for the selection of solder and the temperature control of solder tip.

#### 6-6-1. Correction of soldering Iron

- In order to minimize the damage of MLCC, preheating for MLCC and PCB is necessary.  
Hot plate and hot air type preheater can be used for preheating.
- Do not allow the rapid cooling down for MLCC and PCB after soldering.
- Perform corrections with a soldering iron as quickly as possible since it may cause the problem like the adhesiveness strength due to the leaching phenomenon of the outer termination if the solder iron is applied too long.

Variation of Temp.	Soldering Temp.(°C)	Pre-heating Time(sec)	Soldering Time(sec)	Cooling Time(sec)
$\Delta T \leq 130$	300±10°C max	≥60	≤4	-

\* Control  $\Delta T$  in the solder iron and preheating temperature.

Condition of Iron facilities		
Wattage	Tip diameter	Soldering time
20W max	3 mm max	4sec max

\* Caution - Iron tip should not contact with ceramic body directly

Lead-free solder: Sn-3.0Ag-0.5CU

#### 6-6-2. Correction by spot heater

Compared to local heating using a solder iron, heating by a spot heater tends to lessen the thermal shock since it heats the overall MLCC and printed circuit board.

In case of a high density PCB, a spot heater may also prevent problem that the solder iron makes direct contact with MLCC.

- If the distance from air nozzle outlet to MLCC is too close, the crack can occur due to the thermal stress. In order to prevent this problem, follow the conditions shown in table.
- The angle shown in figure 1 is recommendable so as to make the suitable solder fillet shape.

Distance	5 mm ≤
Hot Air Application angle	45°
Hot Air Temperature Nozzle Outlet	400°C ≥
Application Time	10s >



### 6-6-3. Caution during re-work

- If the solder amount is excessive, the risk of PCB bending or another stressful conditions is higher.
- If the solder amount is too little, a lack of adhesive strength results in MLCC breaking loose from the PCB.
- Check if the solder has been applied properly and the solder fillet of MLCC is well shaped.

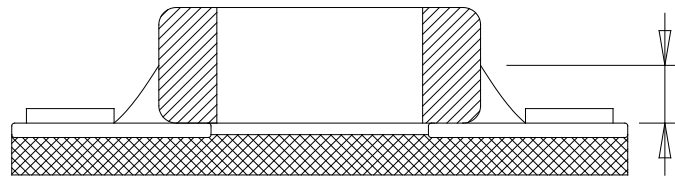

\* Soldering wire below  $\varnothing 0.5\text{mm}$  is required for soldering.

## 6-7. Cleaning

6-7-1. Cleaning is not necessary in general if rosin flux is used.

Strong acidic rosin flux can degrade the performance of MLCC as included chlorine is dissolved to the cleansing solution .

This means that the cleansing solution is selected carefully and is always replaced with new one.

6-7-2. cautions for cleaning

Crack of MLCC or solder joint can occur by the vibration of PCB if the ultra-sonic vibration is excessive during cleaning. In case high pressure cleaning equipment, check if there is any damage of MLCC by testing cleaning equipment and process before cleaning.

## 6-8. Cautions for using electrical measuring probes

Confirm position of the support pin or jig when checking the electrical performance of MLCC after mounting on the PCB.

Be careful of bending of PCB by the pressure of a test-probe, etc.

If the printed circuit board is bent by the force applied to the test probe, it may cause the crack of MLCC or the damage of solder joint.

Avoid flexing by using support pin on the back side of the PCB.

Equipment with support pin as close to the test-probe as possible.

Prevent vibration of the board by shock when a test –probe contacts a printed circuit board.

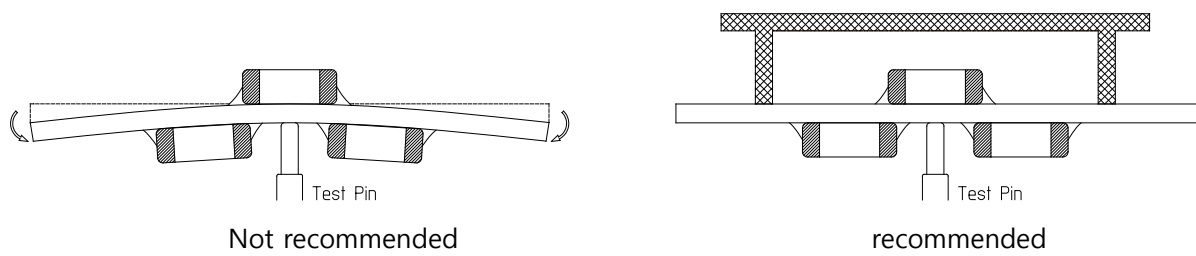

## 6-9. Printed Circuit Board Cropping

Do not apply any stress to the MLCC such as bending or twisting the board after mounting MLCC on the PCB.

The stress as shown may cause MLCC to crack when cutting the board.

Cracked MLCC may cause degradation of the insulation resistance which result in a short-circuit.

Avoid these types of stress applied to MLCC.

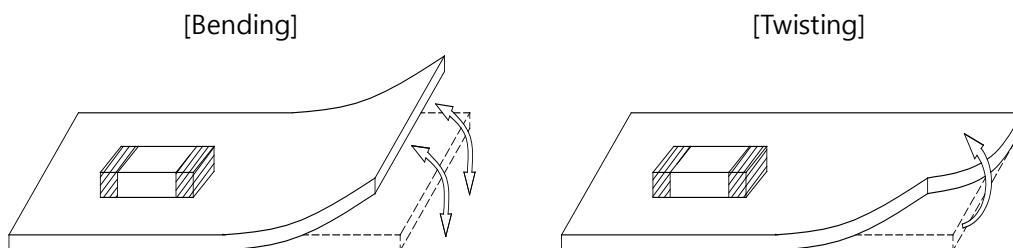

### 6-9-1. Cautions for cutting PCB

Check the cutting method of PCB in advance.

High density mounted PCB will be segregated to many individual board after the completion of mounting.

Bending or deformation of PCB during separation can cause crack of MLCC.

Select carefully the separation method to minimize deformation of PCB.

## 6-10. Assembly Handling

### 6-10-1. Cautions for PCB handling

Hold the edges of the board with both hands since the board may bend if a board mounted with MLCC is held with one hand.

Do not use dropped board as the quality of MLCC may be degraded.

### 6-10-2. Mounting of other components

Use caution to the following items when mounting other components on the back side of the

board after MLCC has been mounted on the front side.

When the suction nozzle is placed too close to the board, board deflection stress may be applied to the MLCC on the bottom side and cracks may occur in the MLCC.

Check if standard value of each chip mounter for suction location, mounting gap and suction gap according to the thickness of component is properly reflected.

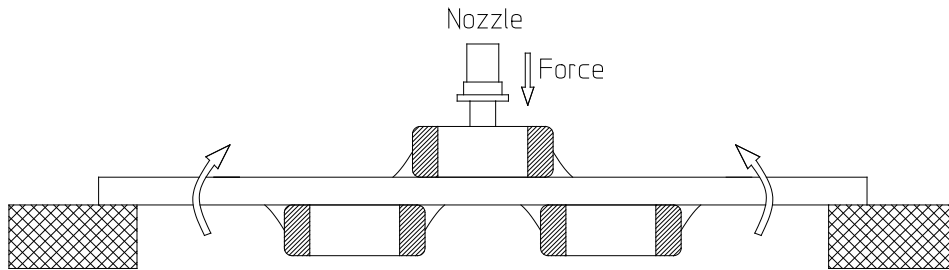

### 6-10-3. Board mounting with leads

When inserting components (transformer, IC, etc.) into board, the crack in the MLCC or solder may occur if the board is bent.

Pay attention to the followings

- Reduce the stress on the board during insertion by increasing the size of the hole to insert the lead.
- After fixing the board with support pin or a dedicated jig, then perform insertion.
- Support below the board so that the board does not bend.
- Check periodically that there is no difference in the height of each support pin when using support pin on the board,.

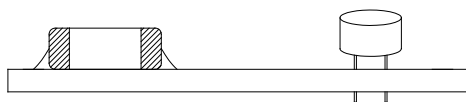

Not recommended

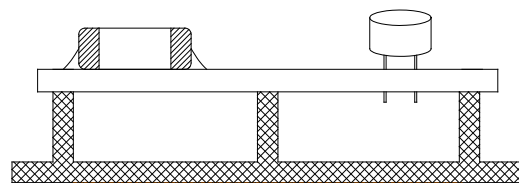

recommended

### 6-10-4. Socket and / or connector attach / detach

Since insertion and removal of socket and connector, etc., may cause the board to bend, make sure that it may damage MLCC mounted on the board due to the bending during working.

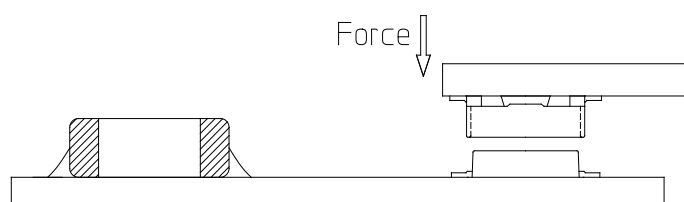

#### 6-10-5. Fastening screw

The board may be bent during tightening screws when attaching a shield, etc to the board .

Use caution to the following items before performing the work.

- Plan the work to prevent the bending of the board.
- Use a torque driver to prevent over-tightening of the screw.
- Since the board may bend by soldering, use caution when tightening the screw

### **6-11. Adhesive selection**

Use caution to the following items if the adhesive is used to fix MLCC on the board before soldering.

#### 6-11-1. Requirements for Adhesives

- Enough adhesive strength to prevent MLCC from slipping or moving during working.
- Maintained when exposed to high temperature during mounting.
- The adhesive should not be spread when applying to PCB.
- It must have a long pot life.
- It must be hardened in a rapid time.
- Do not use the material that corrodes material of MLCC or board.
- Use the good insulating material that does not affect the characteristic of MLCC.
- No toxicity. It must not emit toxic gases and must be safe when contact.

#### 6-11-2. Caution before Adhesive

Check the appropriate conditions when attaching MLCC to the board using an adhesive before mounting MLCC. If the land dimension, the type of adhesive, the amount of coating, the contact surface area, the curing temperature, or other conditions are not appropriate, it may cause the degradation of MLCC characteristic.

#### 6-11-3. Cautions for select Adhesive

According to the type of adhesive, there may be a decrease in insulation resistance.

Besides, there is a possibility that causes the crack of MLCC due to contractile stress by the difference in the contraction rate of MLCC and the adhesive.

#### 6-11-4. Cautions for amount of Adhesive and curing temperature

- The mounting defect of MLCC can be occurred due to the drop of the adhesive strength if there is not enough adhesive.
- It is required to avoid inflow land section since soldering defect, loss of electrical connection, inadequate curing, or slippage of mounting position can be occurred if there is too much

adhesive.

- If the curing temperature is too high or the curing time is too long, the adhesive strength can be reduced. In addition, the solderability may deteriorate due to the oxidation both on outer termination(Sn) of MLCC and surface of the board.

## **6-12. Flux**

6-12-1. An excessive amount of flux generates a large quantity of flux gas which may result in a deterioration of solderability. Accordingly, make flux thin and even overall.

6-12-2. Flux containing highly percentage of halogen may cause oxidization of MLCC's outer termination if cleaning is not done properly. Use flux with a halogen and chlorine content of 0.1% max.

6-12-3. Strong acidic flux can degrade performance of MLCC.

6-12-4. Check attachment status of MLCC and remaining flux surrounding MLCC after mounting.

## **6-13. Coating**

6-13-1. Crack due to Coating

A crack may be caused in the MLCC due to amount of the resin and stress of thermal contraction of the resin during coating process.

The difference of thermal expansion coefficient between in the coating or a molding resin may cause the destruction , deterioration of insulation resistance or dielectric breakdown of MLCC such as crack or detachment, etc.

6-13-2. Recommended Coating material

- Thermal expansion coefficient is as close to that of MLCC as possible
- A silicone resin can be used as an under-coating to buffer against the stress.
- Select a resin that curing contraction rate is as low as possible.
- Select a resin that sensitivity is as low as possible. (ex. Epoxy resin)
- The insulation resistance of MLCC can be deteriorated if high hygroscopicity of resin is used under high humidity condition.
- Do not use strong acid substance since coating material containing halogen system substance and organic acid may corrode MLCC.

## **7. Design**

### **7-1. Circuit design**

In case of the board is dropped or flexed, MLCC mounted on the board can occur short-circuit due to drop of insulation resistance. When MLCC is short-circuit, the safety equipment such as fuse is installed to prevent 2nd incident since electric short and fire may occur. This product is not safety guaranteed product.

### **7-2. PCB Design**

7-2-1. Unlike lead type components, SMD type components are fragile to the stress since they are mounted directly on the board. And they are more susceptible than lead type components in terms of mechanical and thermal stress.

7-2-2. MLCC Crack regards to PCB material

The crack of MLCC may occur due to thermal expansion and contraction in case that the thermal expansion coefficient between PCB and MLCC greatly differs. When MLCC is mounted on a fluorine resin PCB or on a single-layered glass epoxy board, it may cause crack of MLCC.

### **7-3. Design system evaluation**

7-3-1. Make sure if there is no issue for function and specification of the finished goods prior to use through the evaluation of MLCC under the actual system.

7-3-2. Use caution that the capacitance may differ based on operating condition of the actual system since Class 2 MLCC has dependency on voltage and temperature.

7-3-3. Surge resistance must be evaluated since the excessive surge caused by inductance of the actual system may apply to MLCC.

7-3-4. Use caution actual MLCC size and termination shape.

## 7-4 Land dimension

The suitable land dimension is determined by evaluating the actual SET and board.

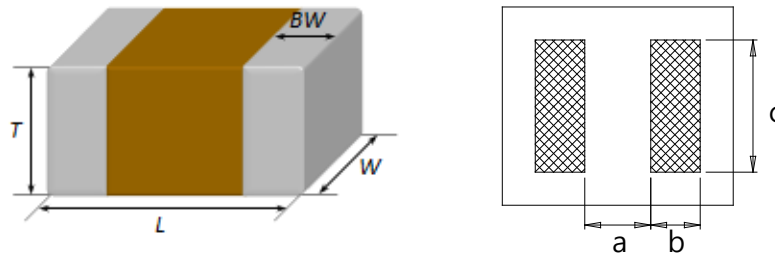

### Reflow Footprint

Chip Size [mm]	Chip Tol. [mm]	a [mm]	b [mm]	c [mm]	(a+2b) min	(a+2b) max
0402	± 0.02	0.14~0.20	0.14~0.22	0.20~0.26	0.42	0.64
0603	± 0.03	0.16~0.20	0.24~0.32	0.30~0.35	0.64	0.84
	± 0.05	0.18~0.26	0.24~0.32	0.32~0.37	0.66	0.9
	± 0.07	0.20~0.28	0.25~0.35	0.35~0.39	0.7	0.98
	± 0.09	0.22~0.30	0.25~0.35	0.35~0.39	0.72	1
1005	± 0.05	0.35~0.40	0.37~0.47	0.50~0.55	1.09	1.34
	± 0.07	0.37~0.42	0.37~0.47	0.52~0.58	1.11	1.36
	± 0.10	0.40~0.45	0.37~0.47	0.55~0.60	1.14	1.39
	± 0.15	0.40~0.45	0.40~0.50	0.60~0.65	1.2	1.45
	± 0.20	0.45~0.50	0.40~0.50	0.65~0.70	1.25	1.5
	± 0.30	0.45~0.50	0.42~0.52	0.70~0.75	1.29	1.54
	± 0.40	0.50~0.55	0.45~0.55	0.75~0.80	1.4	1.65
1608	± 0.10	0.50~0.55	0.60~0.65	0.80~0.85	1.7	1.85
	± 0.15	0.55~0.60	0.62~0.67	0.85~0.90	1.79	1.94
	± 0.20	0.60~0.65	0.65~0.70	0.90~0.95	1.9	2.05
	± 0.25	0.65~0.70	0.70~0.75	0.95~1.00	2.05	2.2
	± 0.30	0.70~0.75	0.75~0.80	1.00~1.05	2.2	2.35
2012	±0.10	0.70~0.75	0.75~0.80	1.25~1.30	2.2	2.35
	±0.15	0.75~0.80	0.80~0.85	1.30~1.35	2.35	2.5
	±0.20	0.80~0.85	0.85~0.90	1.35~1.40	2.5	2.65
	±0.25	0.85~0.90	0.95~1.00	1.40~1.45	2.75	2.9
	±0.30	0.90~0.95	1.05~1.10	1.45~1.50	3	3.15
3216	±0.20	1.70~1.90	0.85~1.00	1.60~1.80	3.4	3.9
	±0.30	1.80~2.00	0.95~1.10	1.70~1.90	3.7	4.2
3225	-	2.00~2.40	1.00~1.40	1.80~2.20	4	5.2
4532	-	2.80~3.20	1.40~1.80	2.40~3.00	5.6	6.8
5750	-	4.00~4.60	1.70~2.30	4.10~4.90	7.4	9.2

### Flow Footprint

Chip Size [mm]	Chip Tol. [mm]	a [mm]	b [mm]	c [mm]	(a+2b) min	(a+2b) max
1608	-	0.60~1.00	0.60~0.80	0.60~0.80	1.8	2.6
2012	-	1.00~1.20	0.80~1.20	0.80~1.20	2.6	3.6
3216	-	2.00~2.40	1.00~1.20	1.00~1.40	4.0	4.8

## 8. Others

### 8-1. Storage environment

#### 8-1-1. Recommendation for temperature/humidity

Even taping and packaging are designed to endure for long-term storage, it should be stored under temperature( 0~40°C) and RH(0~70%) since the quality may deteriorate rapidly if temperature and humidity are too high.

The lower the humidity, the better the solderability since it accelerates the oxidization if relative humidity is above 70%RH.

It is important to keep the temperature control environment since the dew condensation phenomenon may take place by the temperature gap during the storage of product.

#### 8-1-2. Shelf Life

It is recommended to use within 6 months upon shipment in consideration of solderability.

In case of over 6 months storage, it is recommended to use after checking the solderability in advance.

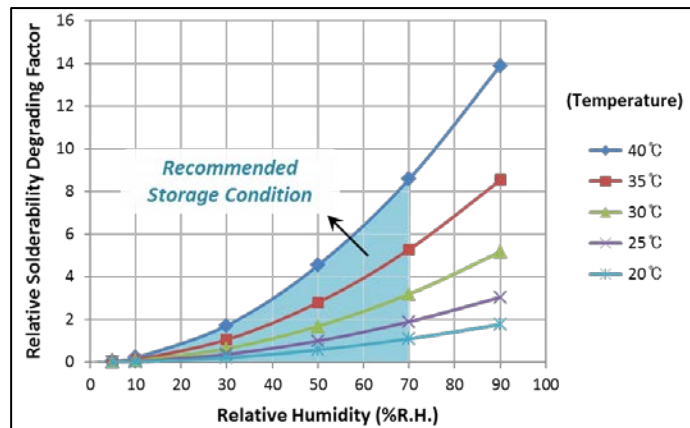

[ Solderability Degradation according to Temperature and Humidity ]

Solderability of MLCC will degrade more rapidly in the presence of high temperature or high Humidity.

\* Relative Solderability Degrading Factor (RSDF)

- Reference : RSDF (25°C, 50%R.H.)

- Examples · RSDF (25°C, 50%R.H.) = 1

· RSDF (40°C, 70%R.H.) = 8.58

→ It means that the solderability under 40°C, 70%R.H. condition will degrade rapidly by 8.58 times compared to 25°C, 50%R.H. condition.



## **8-2. Corrosion**

### 8-2-1. Caution for corrosion environment

Since corrosive gas may deteriorate the solderability of MLCC outer termination, it is important to store MLCC in the environment without corrosive gases. MLCC that is exposed to corrosive gas may occur the quality problem due to the corrosion of plating layers and the penetration of water.

## **8-3. Equipment in operation**

8-3-1. Do not touch MLCC directly with bare hands to prevent an electric shock or damage.

8-3-2. The termination of MLCC shall not be contacted with a conductive object (short –circuit).  
Do not expose MLCC to a conductive liquid containing an acid or alkali material.

8-3-3. Do not use the equipment in the following environments.

- (1) Be exposed to water or oil
- (2) Be exposed to direct sunlight
- (3) Be exposed to Ozone or ultra-violet radiation.
- (4) Be exposed to corrosive gas (e.g. hydrogen sulfide, sulfur dioxide, chlorine, ammonia gas)
- (5) Be exposed to vibration or mechanical shock exceeding specified limit
- (6) The environment where moisture is condensed

8-3-4. In emergency case the equipment generates any smoke, fire or abnormal odor, immediately turn off the equipment or plug off.

Unless the equipment is turned off or plugged off, the dangerousness can be elevated due to the continuous power supply. Be careful about burn by high temperature under this circumstance.

## **8-4. Waste treatment**

In case of scrapping MLCC, it is incinerated or buried by a licensed industrial waste company.

## **8-5. Operating temperature**

The limit of operating temperature is decided by an individual specification.

8-5-1. Do not use MLCC in the range exceeding maximum operating temperature.

It is required to consider temperature distribution of the equipment and the seasonal temperature.

8-5-2. The surface temperature of MLCC cannot be exceeded maximum operating temperature including self-heating.

## **8-6. Transportation**

The performance of MLCC can be affected by conditions during transportation.

8-6-1. MLCC shall be protected from excessive temperature, humidity and mechanical force during transportation.

Transportation shall be done in such a way that the boxes are not deformed and external forces are not delivered directly to the inner packaging.

8-6-2. Do not apply excessive vibration, shock or excessive force to MLCC.

- If the excessive mechanical shock or pressure is applied, it may cause the crack of MLCC ceramic body.
- When a sharp edge of air driver, soldering iron, pincette, etc strongly contact the surface of MLCC, it may cause the crack or short circuit of MLCC.

8-6-3. It cannot be used since there is a possibility of crack due to the abnormal occurrence induced by excessive shock and dropping during transportation

## **8-7. Notice**

Some special products are excluded in this document.

Since this document is standard specification provided as a reference, this document may be subject to change, modify or stop without notice at any time.

Approval of this product manual is required before ordering.

Please consult with our representative if you have any query regarding the product specification.

## Caution of Application

### Disclaimer & Limitation of Use and Application

The products listed in this Specification sheet are NOT designed and manufactured for any use and applications set forth below.

Please note that any misuse of the products deviating from products specifications or information provided in this Spec sheet may cause serious property damages or personal injury.

We will NOT be liable for any damages resulting from any misuse of the products, specifically including using the products for high reliability applications as listed below.

If you have any questions regarding this 'Limitation of Use and Application', you should first contact our sales personnel or application engineers.

- ① Aerospace/Aviation equipment
- ② Medical equipment
- ③ Military equipment
- ④ Disaster prevention/crime prevention equipment
- ⑤ Power plant control equipment
- ⑥ Atomic energy-related equipment
- ⑦ Undersea equipment
- ⑧ Traffic signal equipment
- ⑨ Data-processing equipment
- ⑩ Electric heating apparatus, burning equipment
- ⑪ Safety equipment
- ⑫ Any other applications with the same as or similar complexity or reliability to the applications