



Dynamic Series | Dynamic 1000 Series

TE Internal #: 1-1827864-8

Housing, Receptacle, Wire-to-Board, 16 Position, 2.5 mm [.098 in] Centerline, Crimp, 2 Row, Black, Mating Retention, Wire & Cable, Dynamic 1000 Series

[View on TE.com >](#)

Connectors > PCB Connectors > Wire-to-Board Connectors > Wire-to-Board Connector Assemblies & Housings >

Receptacle and Tab Housing: 2.5 mm Pitch, 250V



Connector Product Type: **Housing**

Connector & Housing Type: **Receptacle**

Connector System: **Wire-to-Board**

Number of Positions: **16**

Centerline (Pitch): **2.5 mm [.098 in]**

[All Receptacle and Tab Housing: 2.5 mm Pitch, 250V \(59\)](#)

Features

Product Type Features

Connector Product Type	Housing
Connector & Housing Type	Receptacle
Connector System	Wire-to-Board
Sealable	No
Connector & Contact Terminates To	Wire & Cable

Configuration Features

Number of Positions	16
Number of Rows	2

Body Features

Primary Product Color	Black
-----------------------	-------

Termination Features

--	--



Termination Method to Wire & Cable	Crimp
------------------------------------	-------

Mechanical Attachment

Mating Retention	With
Connector Mounting Type	Cable Mount (Free-Hanging)

Housing Features

Centerline (Pitch)	2.5 mm [.098 in]
--------------------	------------------

Dimensions

Row-to-Row Spacing	3.3 mm [.129 in]
--------------------	------------------

Usage Conditions

Operating Temperature Range	-55 – 105 °C [-67 – 221 °F]
-----------------------------	-----------------------------

Operation/Application

Circuit Application	Signal
---------------------	--------

Product Compliance

For compliance documentation, visit the product page on [TE.com](https://www.te.com)>

EU RoHS Directive 2011/65/EU	Compliant
EU ELV Directive 2000/53/EC	Compliant
China RoHS 2 Directive MIIT Order No 32, 2016	No Restricted Materials Above Threshold
EU REACH Regulation (EC) No. 1907/2006	Current ECHA Candidate List: JUNE 2024 (241) Candidate List Declared Against: JUNE 2024 (241) Does not contain REACH SVHC
Halogen Content	Not Low Halogen - contains Br or Cl > 900 ppm.
Solder Process Capability	Not applicable for solder process capability

Product Compliance Disclaimer

This information is provided based on reasonable inquiry of our suppliers and represents our current actual knowledge based on the information they provided. This information is subject to change. The part numbers that TE has identified as EU RoHS compliant have a maximum concentration of 0.1% by weight in homogenous materials for lead, hexavalent chromium, mercury, PBB, PBDE, DBP, BBP, DEHP, DIBP, and 0.01% for cadmium, or qualify for an exemption to these limits as defined in the Annexes of Directive 2011/65/EU (RoHS2). Finished electrical and electronic equipment products will be CE marked as required by Directive 2011/65/EU. Components may not be CE marked. Additionally, the part numbers that TE has identified as EU ELV compliant have a maximum concentration of 0.1% by weight in homogenous materials for lead, hexavalent chromium, and mercury, and 0.01% for cadmium, or qualify for an exemption to these limits as defined in the Annexes of Directive 2000/53/EC (ELV). Regarding the REACH Regulation, the information TE provides on SVHC in articles for this part number is based on the latest European Chemicals Agency (ECHA) 'Guidance on requirements for substances in articles' posted at this URL: <https://echa.europa.eu/guidance-documents/guidance-on-reach>

Compatible Parts



Also in the Series | Dynamic 1000 Series

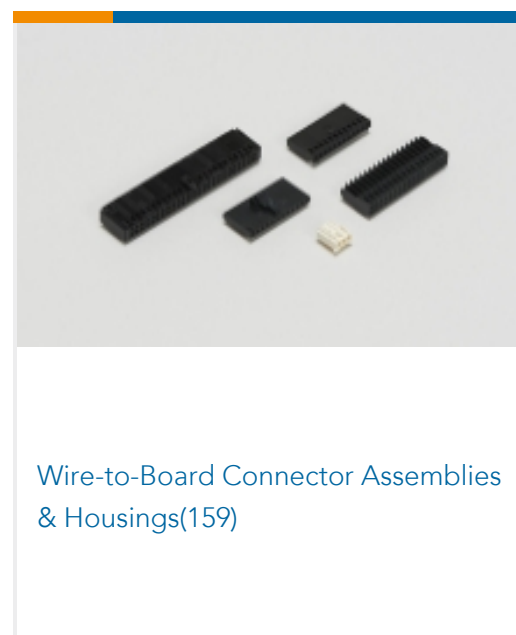
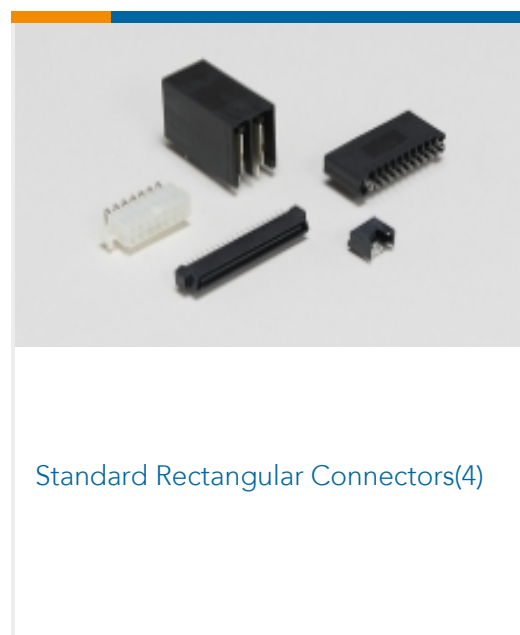
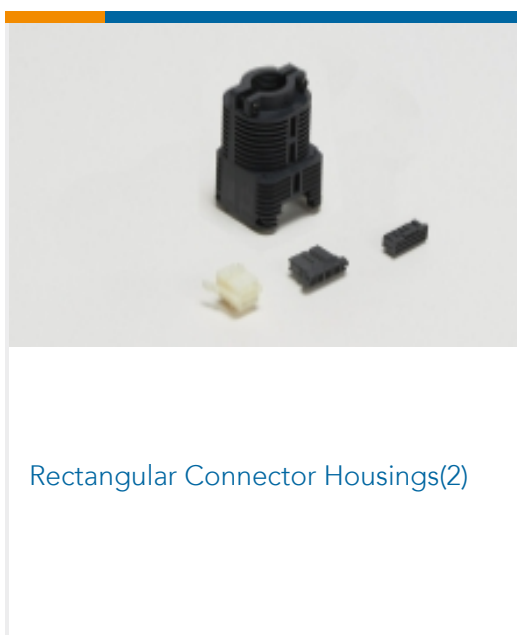
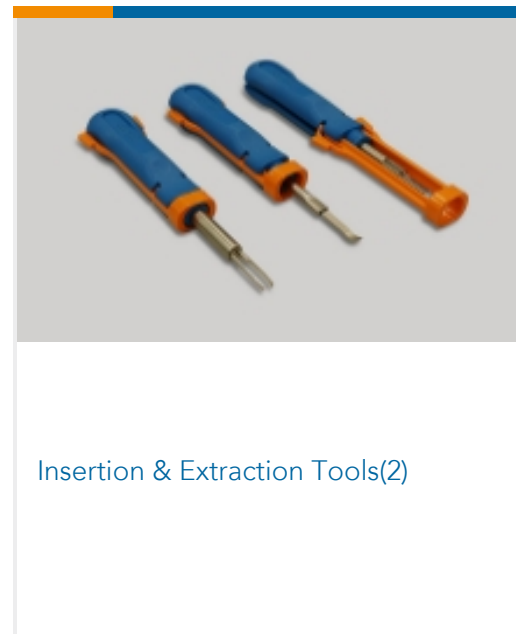
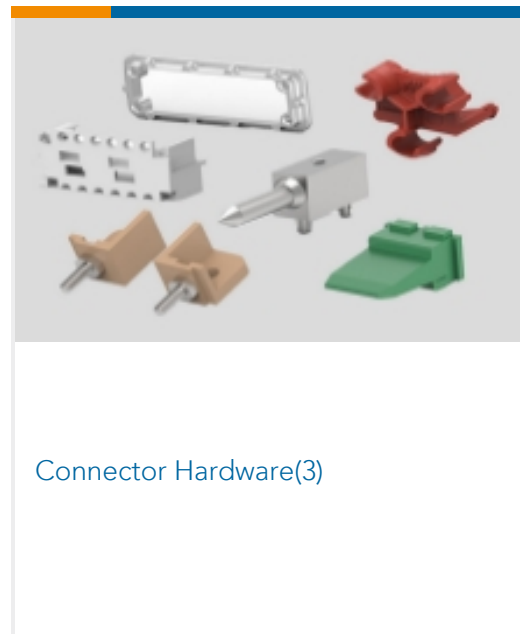
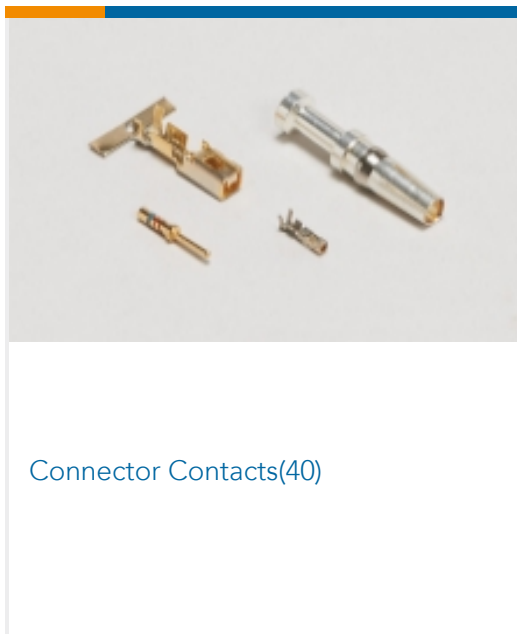

Customers Also Bought



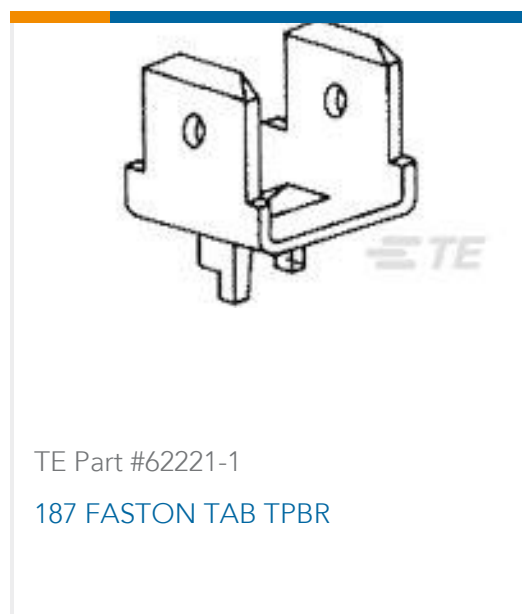

Documents

Product Drawings

[DYNAMIC 1200D REC HSG 16PX BLACK](#)

English

CAD Files

Customer View Model

[ENG_CVM_CVM_1-1827864-8_P.2d_dxf.zip](#)

English

[3D PDF](#)

3D

Customer View Model

[ENG_CVM_CVM_1-1827864-8_P.3d_igs.zip](#)

English

Customer View Model

[ENG_CVM_CVM_1-1827864-8_P.3d_stp.zip](#)

English

By downloading the CAD file I accept and agree to the [Terms and Conditions](#) of use.

Product Specifications

[Application Specification](#)

English

Instruction Sheets

[Instruction Sheet \(non U.S.\)](#)

English

Agency Approvals

[TUV Certificate](#)

English