

# PSI-MOS-RS485W2/FO1300 E - FO converters



2708562

<https://www.phoenixcontact.com/us/products/2708562>

Please be informed that the data shown in this PDF document is generated from our online catalog. Please find the complete data in the user documentation. Our general terms of use for downloads are valid.



FO converter with integrated optical diagnostics, alarm contact, for RS-485 2-wire bus systems (SUCONET K, MODBUS ...) up to 500 kbps, NRZ coding, termination device with an FO interface (SC-Duplex), 1300 nm, for fiberglass cable

## Product description

The **PSI-MOS-RS485W2/FO...** FO converters convert the electrical data signal into an optical one by protocol transparent means. The integrated optical diagnostics allow permanent monitoring of the FO paths during installation and also during operation. The floating switch contact is activated when the signal output on the fiber optic paths drops to a critical level. The **PSI-MOS-RS485W2/FO... E** termination devices convert an RS-485 interface to a fiber optic cable. They are ideal for point-to-point connections.

## Your advantages

- Connections can be plugged in via a COMBICON screw terminal block
- Supply voltage and data signals routed through the DIN rail connectors
- Can be combined with the PSI copper repeater in a modular way using DIN rail connectors
- Automatic data rate detection or fixed data rate setting via DIP switches
- Redundant power supply possible by means of optional system power supply unit
- High-quality electrical isolation between all interfaces (RS-485 // fiber optic ports // power supply // DIN rail connector)
- Approved for use in zone 2
- Floating switch contact for advance warning of critical FO paths
- Integrated optical diagnostics for continuous monitoring of FO paths
- Suitable for data rates up to 500 kbps

## Commercial data

Item number	2708562
Packing unit	1 pc
Minimum order quantity	1 pc
Sales key	DN06
Product key	DNC212
Catalog page	Page 435 (C-6-2019)
GTIN	4046356176279
Weight per piece (including packing)	241.3 g
Weight per piece (excluding packing)	241.3 g
Customs tariff number	85176200
Country of origin	DE

## Technical data

### Notes

#### Utilization restriction

CCCex note	Use in potentially explosive areas is not permitted in China.
------------	---

### Product properties

Product type	Media converter
MTTF	903 Years (SN 29500 standard, temperature 25°C, operating cycle 21%)
	412 Years (SN 29500 standard, temperature 40°C, operating cycle 34.25%)
	169 Years (SN 29500 standard, temperature 40°C, operating cycle 100%)
MTBF	484 Years (Telcordia standard, 25°C temperature, 21% operating cycle (5 days a week, 8 hours a day))
	102 Years (Telcordia standard, 40°C temperature, 34.25% operating cycle (5 days a week, 12 hours a day))

### Electrical properties

Electrical isolation	VCC // RS-485
Maximum power dissipation for nominal condition	1.375 W
Test voltage data interface/power supply	1.5 kV <sub>rms</sub> (50 Hz, 1 min.)

#### Supply

Supply voltage range	18 V DC ... 32 V DC
Nominal supply voltage	24 V DC (in acc. with UL)
Typical current consumption	55 mA (24 V DC)
Max. current consumption	90 mA
	≤ 2 A (For operation in a joining station, via the DIN rail connector)

### Output data

#### Switching

Output name	Relay output
Output description	Alarm output
Number of outputs	1
Maximum switching voltage	60 V DC (Resistive Load, General Load)
	30 V AC (Resistive load)
	42 V AC (peak, resistive load)
Limiting continuous current	0.46 A

### Connection data

#### Supply

# PSI-MOS-RS485W2/FO1300 E - FO converters



2708562

<https://www.phoenixcontact.com/us/products/2708562>

Connection method	COMBICON plug-in screw terminal block
Stripping length	7.00 mm
Tightening torque	0.56 Nm ... 0.79 Nm

## Interfaces

Bit distortion, input	± 35 % (permitted)
Bit distortion, output	< 6.25 %
Signal	Modbus
	S-BUS
	Suconet K
	J-BUS
	DATA HIGHWAY

### Data: optical FO

No. of channels	1
Transmit capacity, minimum	-3.4 dBm (50/125 µm, multimode fiberglass)
	-4.7 dBm (62.5/125 µm, multimode fiberglass)
	-5.5 dBm (9/125 µm, singlemode fiberglass)
Transmission length incl. 3 dB system reserve	25 km (With F-G 50/125 0.7 dB/km at 1300 nm)
	22 km (with F-G 62.5/125 0.8 dB/km at 1300 nm)
	45 km (With F-E 9/125 0,4 dB/km at 1300 nm)
Transmission protocol	Protocol-transparent to the RS-485 interface
Connection method	SC duplex
Wavelength	1300 nm
Minimum receiver sensitivity	-25.5 dBm (50/125 µm)
	-25.5 dBm (62,5/125 µm)
	-26.5 dBm (9/125 µm)
Maximum receiver sensitivity	0 dBm (9/125 µm)
Transmission medium	Multi-mode fiberglass
	Single-mode fiberglass

### Data: RS-485 interface, 2-wire

Serial transmission speed	4.8/ 9.6/ 19.2/ 38.4/ 57.6/ 75/ 93.75/ 115.2/ 136/ 187.5/ 375/ 500 kbps
Connection method	Pluggable screw connection
Transmission length	≤ 1200 m (depending on the data rate, with shielded, twisted data cable)
Termination resistor	390 Ω (Can be connected)
	220 Ω
	390 Ω
Single conductor/terminal point, rigid	0.2 mm <sup>2</sup> ... 2.5 mm <sup>2</sup>
Single-wire/terminal point, flexible	0.2 mm <sup>2</sup> ... 2.5 mm <sup>2</sup>
Max. AWG conductor cross section, flexible	14
Min. AWG conductor cross section, flexible	24
Single-wire/terminal point, rigid AWG max.	14

# PSI-MOS-RS485W2/FO1300 E - FO converters



2708562

<https://www.phoenixcontact.com/us/products/2708562>

Single-wire/terminal point, rigid AWG min.	24
Transmission medium	Copper
File format/coding	UART (11/10 bit switchable; NRZ), slip-tolerant
Data direction switching	Automatic control

## Dimensions

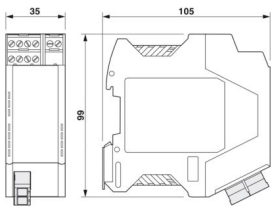
Dimensional drawing	
Width	35 mm
Height	99 mm
Depth	105 mm

## Material specifications

Color (Housing)	gray (RAL 7042)
Material (Housing)	PA 6.6-FR

## Cable/line

FO cable	
Fiber types	50/125 µm
	9/125 µm
	Fiberglass

## Environmental and real-life conditions

Ambient conditions	
Degree of protection	IP20
Ambient temperature (operation)	-20 °C ... 60 °C
Ambient temperature (storage/transport)	-40 °C ... 85 °C
Altitude	≤ 5000 m (For restrictions, see the manufacturer's declaration for altitude operation)
	≤ 2000 m (Hazardous locations)
Permissible humidity (operation)	30 % ... 95 % (non-condensing)

## Approvals

CE	
Certificate	CE-compliant

ATEX	
Identification	Ⓔ II 3 G Ex ec IIC T4 Gc
Certificate	UL 21 ATEX 2550X

# PSI-MOS-RS485W2/FO1300 E - FO converters



2708562

<https://www.phoenixcontact.com/us/products/2708562>

Note	Please follow the special installation instructions in the documentation!
------	---

## IECEX

Identification	Ex ec IIC T4 Gc
Certificate	IECEX ULD 21.00013X

## UL, USA/Canada

Identification	Class I, Zone 2, AEx ec IIC T4 Gc
	Ex ec IIC T4 Gc X
	Class I, Div. 2, Groups A, B, C, D

## Corrosive gas test

Identification	ISA-S71.04-1985 G3 Harsh Group A
----------------	----------------------------------

## EMC data

Noise immunity	EN 61000-6-2
Electromagnetic compatibility	Conformance with EMC Directive 2014/30/EU
Noise emission	EN 55011

## Electrostatic discharge

Standards/regulations	EN 61000-4-2
-----------------------	--------------

## Electrostatic discharge

Contact discharge	± 6 kV
Discharge in air	± 8 kV
Comments	Criterion B

## Electromagnetic HF field

Standards/regulations	EN 61000-4-3
-----------------------	--------------

## Electromagnetic HF field

Field intensity	10 V/m
Comments	Criterion A

## Fast transients (burst)

Standards/regulations	EN 61000-4-4
-----------------------	--------------

## Fast transients (burst)

Input	± 2 kV
Signal	± 2 kV
Comments	Criterion B

## Surge current load (surge)

Standards/regulations	EN 61000-4-5
-----------------------	--------------

## Surge current load (surge)

Input	± 0.5 kV
Signal	± 1 kV

# PSI-MOS-RS485W2/FO1300 E - FO converters



2708562

<https://www.phoenixcontact.com/us/products/2708562>

Comments	Criterion B
----------	-------------

## Conducted interference

Standards/regulations	EN 61000-4-6
-----------------------	--------------

## Conducted interference

Comments	Criterion A
Voltage	10 V

## Emitted interference

Standards/regulations	EN 55011
Comments	Class A, industrial applications

## Criteria

Criterion A	Normal operating behavior within the specified limits.
Criterion B	Temporary impairment to operational behavior that is corrected by the device itself.

## Standards and regulations

Free from substances that could impair the application of coating	in accordance with VW-AUDI-Seat central standard P-VW 3.10.7 57 65 0
---	--

## Mounting

Mounting type	DIN rail mounting
---------------	-------------------

# PSI-MOS-RS485W2/FO1300 E - FO converters



2708562

<https://www.phoenixcontact.com/us/products/2708562>

## Drawings

Dimensional drawing

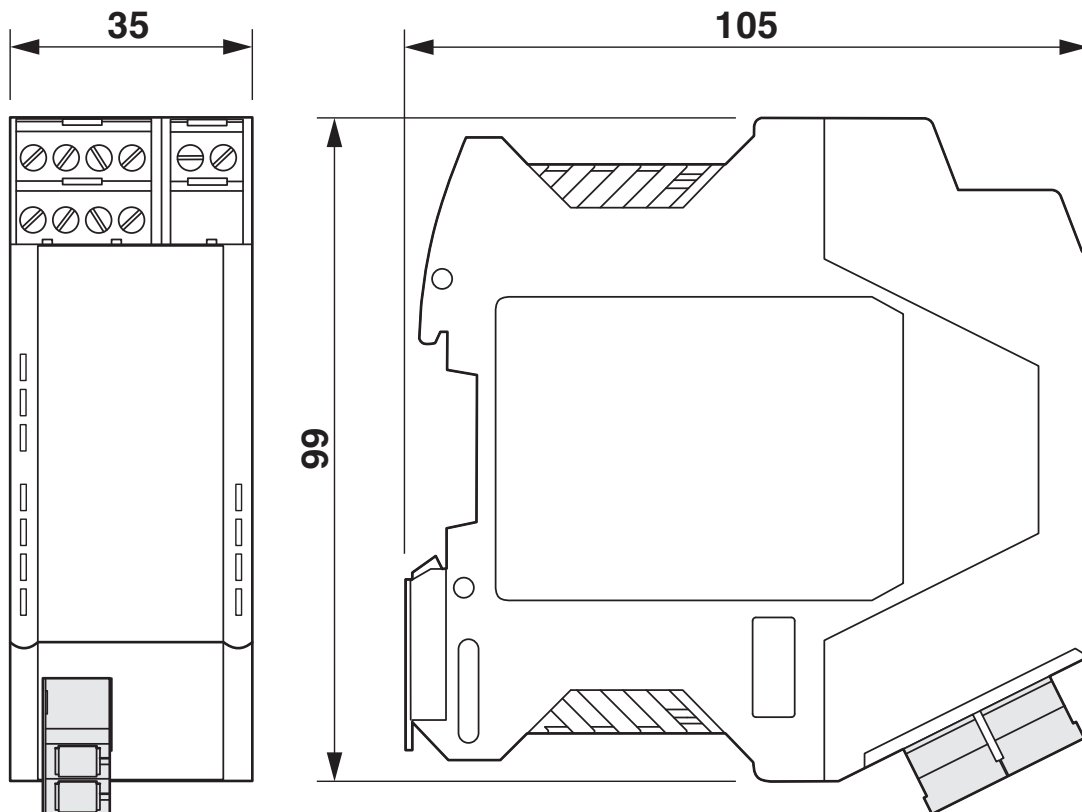

Housing dimensions

# PSI-MOS-RS485W2/FO1300 E - FO converters



2708562

<https://www.phoenixcontact.com/us/products/2708562>

Application drawing

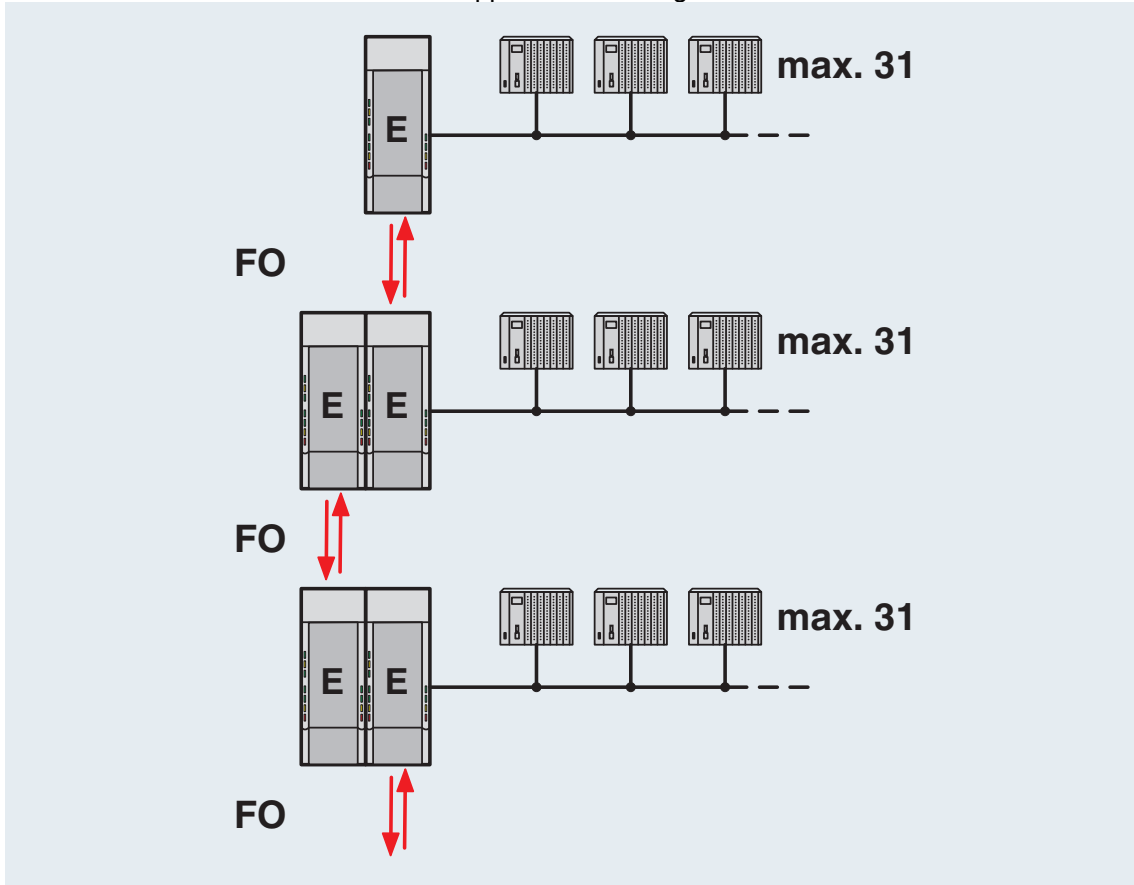

Line structure



Application drawing

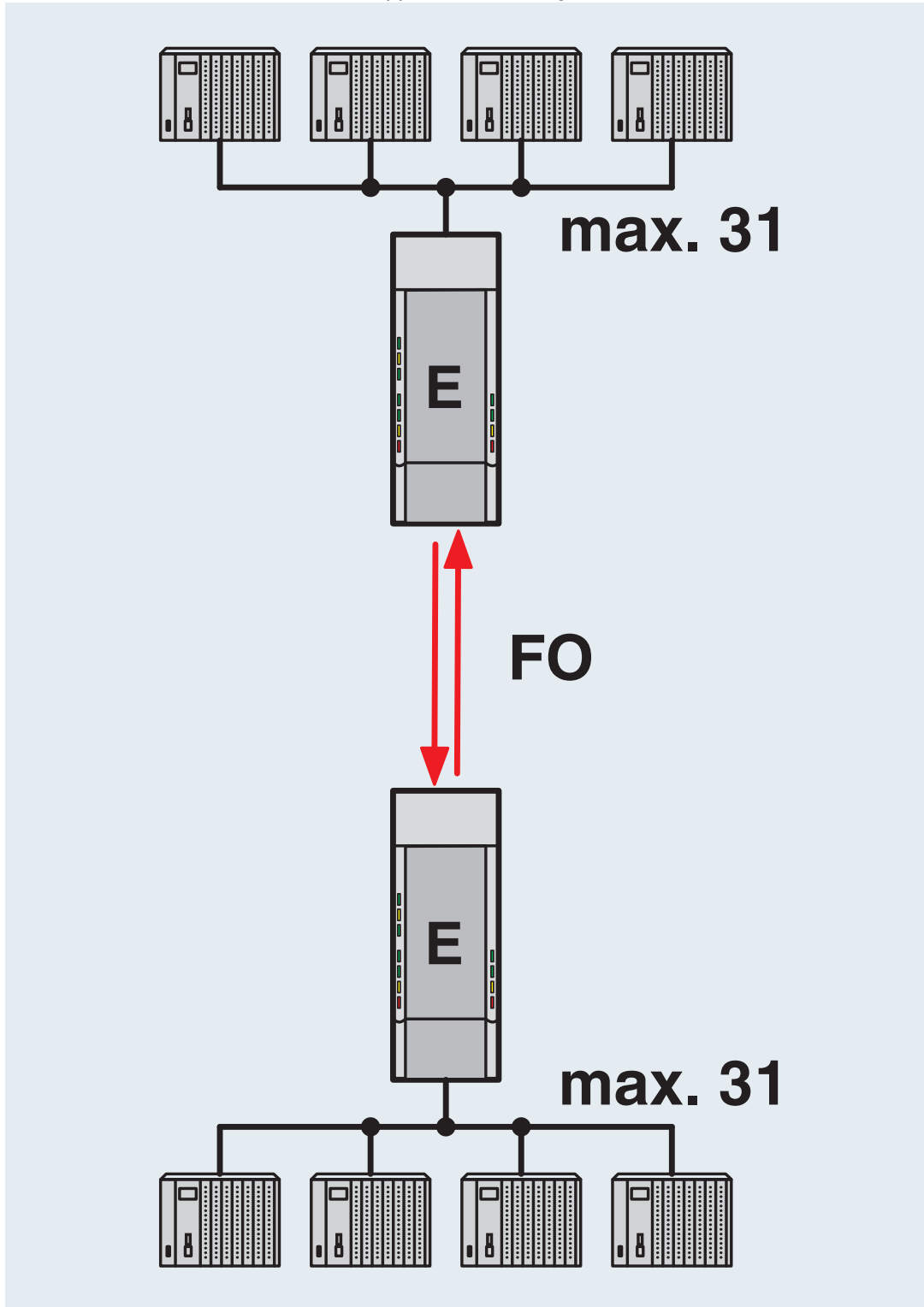

Point-to-point connection

# PSI-MOS-RS485W2/FO1300 E - FO converters



2708562

<https://www.phoenixcontact.com/us/products/2708562>

Schematic diagram

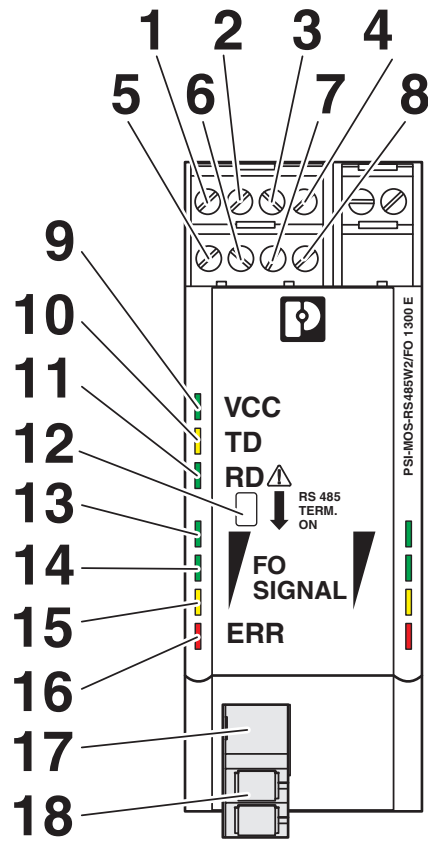

Front view

# PSI-MOS-RS485W2/FO1300 E - FO converters



2708562

<https://www.phoenixcontact.com/us/products/2708562>

Schematic diagram

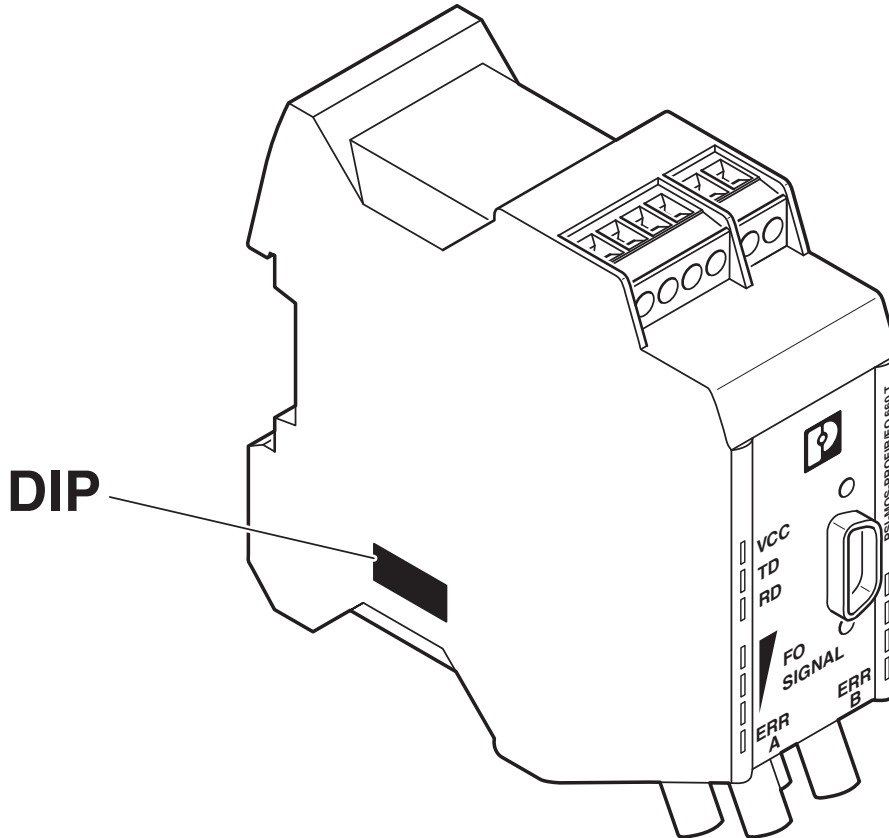

Position of DIP switches

Block diagram

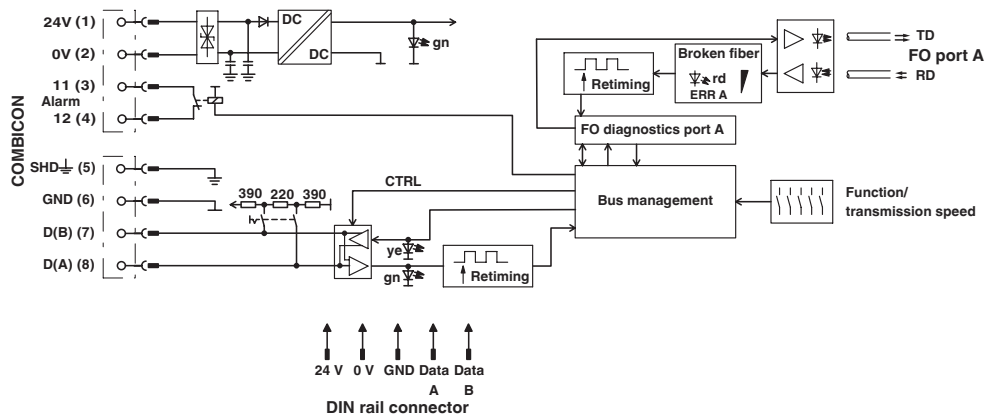

Basic circuit diagram

Application drawing

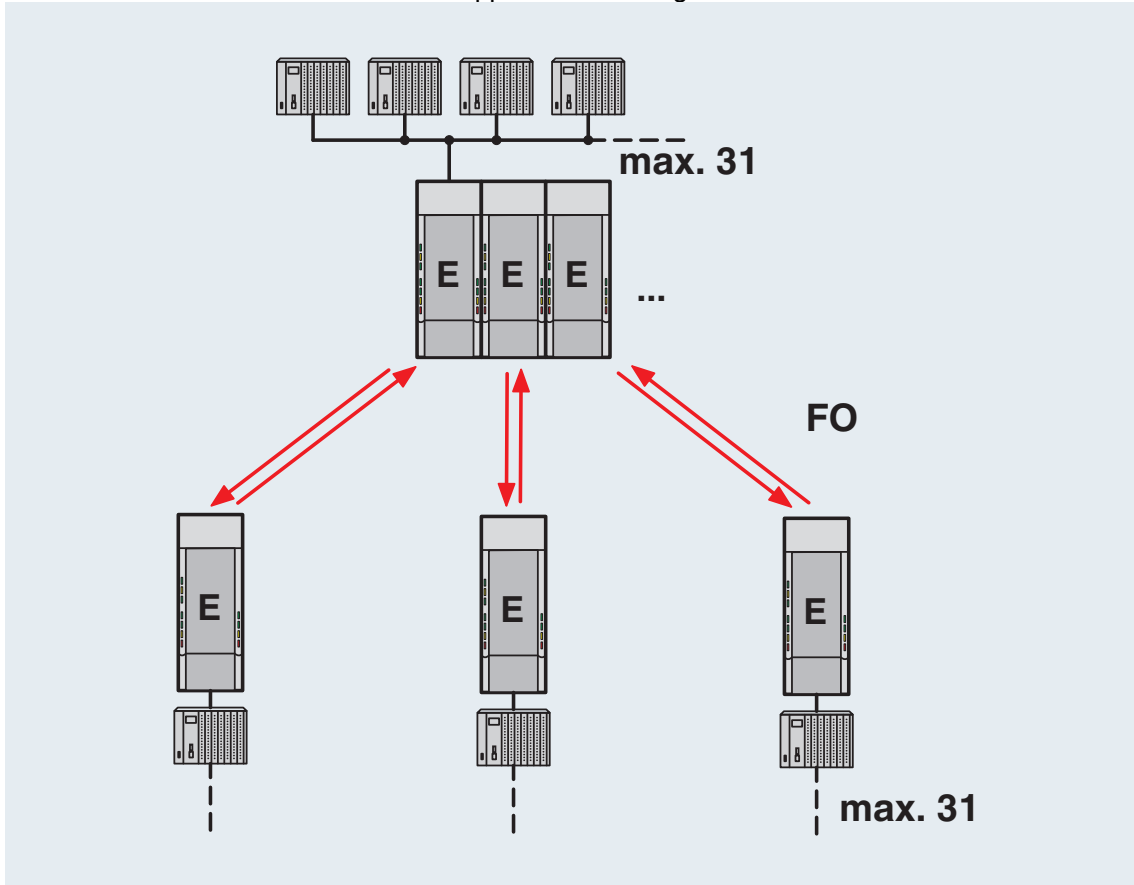

Star structure

2708562

<https://www.phoenixcontact.com/us/products/2708562>

Application drawing

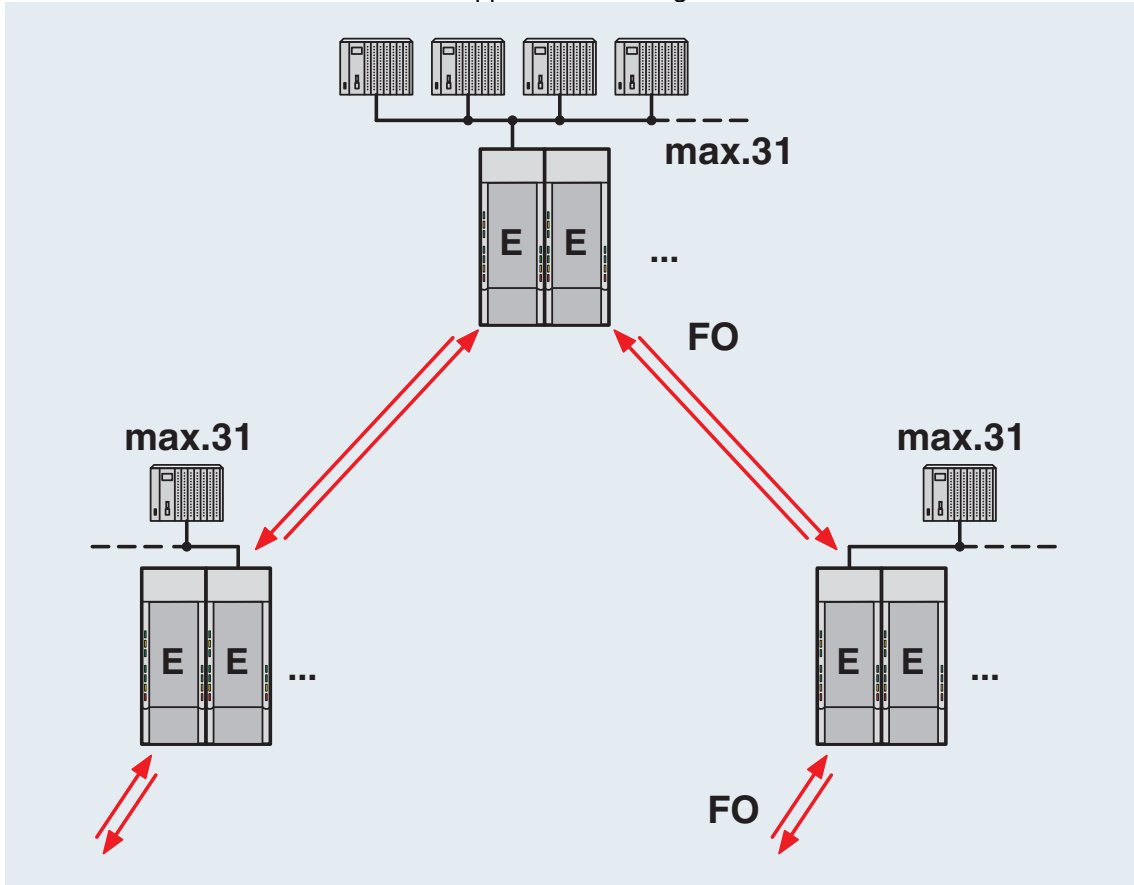

Tree structure

# PSI-MOS-RS485W2/FO1300 E - FO converters



2708562

<https://www.phoenixcontact.com/us/products/2708562>

## Approvals

To download certificates, visit the product detail page: <https://www.phoenixcontact.com/us/products/2708562>



**EAC**

Approval ID: TR TS\_D\_01871-19

**UAE-RoHS**

Approval ID: 23-02-63194



**cULus Listed**

Approval ID: E238705



**ATEX**

Approval ID: PxCIF07ATEX2708559X



**IECEx**

Approval ID: IECEx ULD 21.0013X



**cUL Listed**

Approval ID: FILE E 199827



**UL Listed**

Approval ID: FILE E 199827



**ATEX**

Approval ID: UL 21 ATEX 2550X

**cULus Listed**

# PSI-MOS-RS485W2/FO1300 E - FO converters



2708562

<https://www.phoenixcontact.com/us/products/2708562>

## Classifications

### ECLASS

ECLASS-11.0	19170411
ECLASS-12.0	19170411
ECLASS-13.0	19170411

### ETIM

ETIM 9.0	EC001467
----------	----------

### UNSPSC

UNSPSC 21.0	43201500
-------------	----------

2708562

<https://www.phoenixcontact.com/us/products/2708562>

## Environmental product compliance

### EU RoHS

Fulfills EU RoHS substance requirements	Yes
Exemption	7(c)-I

### China RoHS

Environment friendly use period (EFUP)	EFUP-50
	An article-related China RoHS declaration table can be found in the download area for the respective article under "Manufacturer declaration". For all articles with EFUP-E, no China RoHS declaration table issued and required.

### EU REACH SVHC

REACH candidate substance (CAS No.)	No substance above 0.1 wt%
-------------------------------------	----------------------------



# PSI-MOS-RS485W2/FO1300 E - FO converters



2708562

<https://www.phoenixcontact.com/us/products/2708562>

## Accessories

### QUINT4-SYS-PS/1AC/24DC/2.5/SC - Power supply unit

2904614

<https://www.phoenixcontact.com/us/products/2904614>



Primary-switched power supply, QUINT POWER, screw connection, DIN rail mounting, supply of devices possible via the TBUS DIN rail connector, protective coating, input: single-phase, output: 24 V DC/2.5 A

---

### ME 17,5 TBUS 1,5/ 5-ST-3,81 KMGY - DIN rail bus connectors

2713645

<https://www.phoenixcontact.com/us/products/2713645>

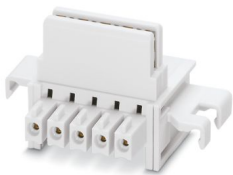

DIN rail connector, color: light grey, nominal current: 8 A (parallel contacts), rated voltage (III/2): 125 V, number of positions: 5, product range: TBUS5-17,5..., pitch: 3.81 mm, mounting: DIN rail mounting, locking: without, mounting: without, type of packaging: packed in cardboard, Item with gold-plated contacts, bus connectors for connecting with electronics housings, 5 parallel contacts

# PSI-MOS-RS485W2/FO1300 E - FO converters



2708562

<https://www.phoenixcontact.com/us/products/2708562>

## FOC-LC:PA-SC:PA-OM2:D01/1 - FO patch cable

1115607

<https://www.phoenixcontact.com/us/products/1115607>

Multi-mode OM2 duplex jumper, LC-SC, UPC polishing, length 1 m

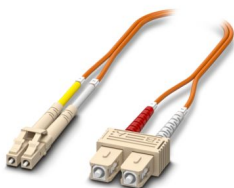

---

## FOC-LC:PA-SC:PA-OM2:D01/2 - FO patch cable

1115605

<https://www.phoenixcontact.com/us/products/1115605>

Multi-mode OM2 duplex jumper, LC-SC, UPC polishing, length 2 m

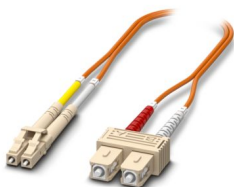

# PSI-MOS-RS485W2/FO1300 E - FO converters



2708562

<https://www.phoenixcontact.com/us/products/2708562>

## FOC-SC:PA-SC:PA-OM2:D01/1 - FO patch cable

1115536

<https://www.phoenixcontact.com/us/products/1115536>

Multi-mode OM2 duplex jumper, SC-SC, UPC polishing, length 1 m

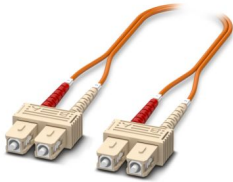

---

## FOC-SC:PA-SC:PA-OM2:D01/2 - FO patch cable

1115535

<https://www.phoenixcontact.com/us/products/1115535>

Multi-mode OM2 duplex jumper, SC-SC, UPC polishing, length 2 m

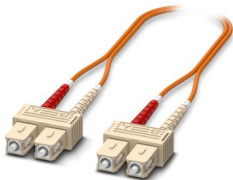

# PSI-MOS-RS485W2/FO1300 E - FO converters



2708562

<https://www.phoenixcontact.com/us/products/2708562>

## FOC-ST:PA-SC:PA-OM2:D01/1 - FO patch cable

1115574

<https://www.phoenixcontact.com/us/products/1115574>

Multi-mode OM2 duplex jumper, ST-SC, UPC polishing, length 1 m

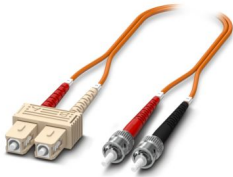

---

## FOC-ST:PA-SC:PA-OM2:D01/2 - FO patch cable

1115573

<https://www.phoenixcontact.com/us/products/1115573>

Multi-mode OM2 duplex jumper, ST-SC, UPC polishing, length 2 m

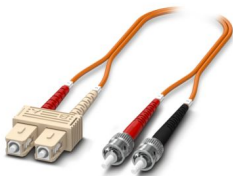

# PSI-MOS-RS485W2/FO1300 E - FO converters



2708562

<https://www.phoenixcontact.com/us/products/2708562>

## FOC-LC:PA-SC:PA-OM4:D01/1 - FO patch cable

1115601

<https://www.phoenixcontact.com/us/products/1115601>

Multi-mode OM4 duplex jumper, LC-SC, UPC polishing, length 1 m

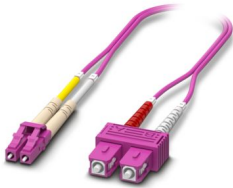

---

## FOC-LC:PA-SC:PA-OM4:D01/2 - FO patch cable

1115600

<https://www.phoenixcontact.com/us/products/1115600>

Multi-mode OM4 duplex jumper, LC-SC, UPC polishing, length 2 m

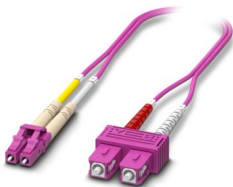

# PSI-MOS-RS485W2/FO1300 E - FO converters



2708562

<https://www.phoenixcontact.com/us/products/2708562>

## FOC-SC:PA-SC:PA-OM4:D01/1 - FO patch cable

1115424

<https://www.phoenixcontact.com/us/products/1115424>

Multi-mode OM4 duplex jumper, SC-SC, UPC polishing, length 1 m

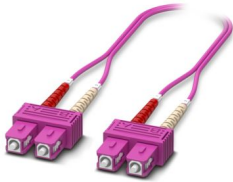

---

## FOC-SC:PA-SC:PA-OM4:D01/2 - FO patch cable

1115423

<https://www.phoenixcontact.com/us/products/1115423>

Multi-mode OM4 duplex jumper, SC-SC, UPC polishing, length 2 m

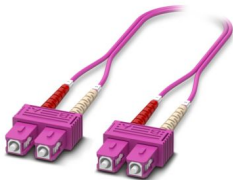

# PSI-MOS-RS485W2/FO1300 E - FO converters



2708562

<https://www.phoenixcontact.com/us/products/2708562>

## FOC-SC:PA-SC:PA-OS2:D01/1 - FO patch cable

1115550

<https://www.phoenixcontact.com/us/products/1115550>

Single-mode OS2 duplex jumper, SC-SC, UPC polishing, length 1 m

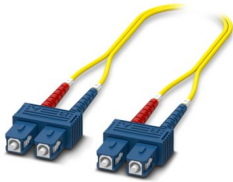

---

## FOC-SC:PA-SC:PA-OS2:D01/2 - FO patch cable

1115548

<https://www.phoenixcontact.com/us/products/1115548>

Single-mode OS2 duplex jumper, SC-SC, UPC polishing, length 2 m

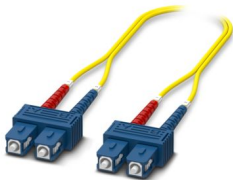

# PSI-MOS-RS485W2/FO1300 E - FO converters



2708562

<https://www.phoenixcontact.com/us/products/2708562>

## FOC-ST:PA-SC:PA-OS2:D01/1 - FO patch cable

1115582

<https://www.phoenixcontact.com/us/products/1115582>

Single-mode OS2 duplex jumper, ST-SC, UPC polishing, length 1 m

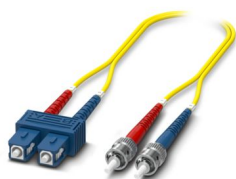

---

## FOC-ST:PA-SC:PA-OS2:D01/2 - FO patch cable

1115581

<https://www.phoenixcontact.com/us/products/1115581>

Single-mode OS2 duplex jumper, ST-SC, UPC polishing, length 2 m

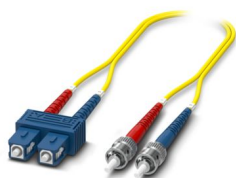



# PSI-MOS-RS485W2/FO1300 E - FO converters



2708562

<https://www.phoenixcontact.com/us/products/2708562>

## FOC-LC:PA-SC:PA-OS2:D01/1 - FO patch cable

1115618

<https://www.phoenixcontact.com/us/products/1115618>

Single-mode OS2 duplex jumper, LC-SC, UPC polishing, length 1 m

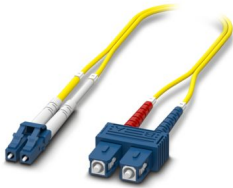

---

## FOC-LC:PA-SC:PA-OS2:D01/2 - FO patch cable

1115617

<https://www.phoenixcontact.com/us/products/1115617>

Single-mode OS2 duplex jumper, LC-SC, UPC polishing, length 2 m

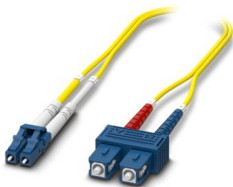

# PSI-MOS-RS485W2/FO1300 E - FO converters



2708562

<https://www.phoenixcontact.com/us/products/2708562>

## FOC-GDM-RUGGED-1016/IP20/... - FO patch cable

2901558

<https://www.phoenixcontact.com/us/products/2901558>

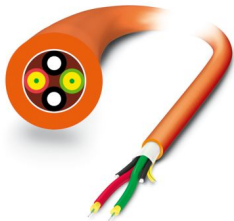

Robust GOF installation cable for assembly (IP20 heads only) for installation in stationary systems and machines, aramid strain-relief elements, with individual elements made from FRNC material, halogen-free, ozone and UV resistant, with a polyurethane (PUR) outer sheath

---

## FOC-GDO-1017/IP20/... - FO patch cable

2901559

<https://www.phoenixcontact.com/us/products/2901559>



Highly rugged GOF round cable (IP20 heads only) for assembly and for outdoor installation with integrated moisture barrier as well as rodent-proof scrim. Individual elements made from highly flexible FRNC material. The wire is ozone and UV resistant with a very rugged polyethylene outer sheath.

# PSI-MOS-RS485W2/FO1300 E - FO converters



2708562

<https://www.phoenixcontact.com/us/products/2708562>

## PSM-LWL-GDO- 50/125 - FO cable

2799432

<https://www.phoenixcontact.com/us/products/2799432>



Fiberglass cable, duplex 50/125  $\mu\text{m}$ , by the meter, without connector, for outdoor installation

---

## PSM-LWL-GDM-RUGGED- 50/125 - FO cable

2799322

<https://www.phoenixcontact.com/us/products/2799322>

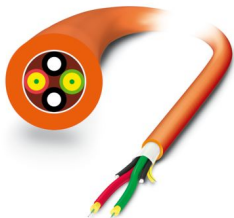

Fiber glass cable, duplex 50  $\mu\text{m}$ /125  $\mu\text{m}$ , by the meter, without male connector, for installation in stationary systems and machines

# PSI-MOS-RS485W2/FO1300 E - FO converters



2708562

<https://www.phoenixcontact.com/us/products/2708562>

## PSI-TERMINATOR-PB-TBUS - Termination resistor

2702636

<https://www.phoenixcontact.com/us/products/2702636>



Active termination resistor for PROFIBUS and RS-485 bus systems, redundant power supply, routing of the supply voltage via DIN rail connector, electrical isolation, switchable termination, integrated programming interface

---

Phoenix Contact 2024 © - all rights reserved

<https://www.phoenixcontact.com>

Phoenix Contact USA  
586 Fulling Mill Road  
Middletown, PA 17057, United States  
(+717) 944-1300  
[info@phoenixcon.com](mailto:info@phoenixcon.com)