

# Rotary Pulse Indicator K3HB-R

CSM\_K3HB-R\_DS\_E\_16\_3

## Digital Rotary Pulse Meter Capable of 50 kHz Measurements

- Visual confirmation of judgement results through display colors that switch between red and green. \*1

- Measures High-speed Pulses at 50 kHz.

Provides high-speed pulse measurements up to 50 kHz of rotary encoder or ON/OFF pulse signals and can perform rotating measurement of high-speed rotating objects.

**Note:** No-voltage contacts of up to 30 Hz are supported.

- Six Measurement Operations Including Rotation (rpm)/Circumferential Speed, Ratio, and Cumulative

One Rotary Pulse Meter has 6 rotary pulse measurement functions to support a variety of pulse measurement applications. Select the best function for your application from the following: Rotation (rpm)/circumferential speed/instantaneous flowrate (value proportional to frequency), absolute ratio, error ratio, error, flow rate ratio, and passing speed (value inversely proportional to frequency).

- DeviceNet models added to the series. \*2

\*1 Visual confirmation of judgement results is not supported on models that do not have an output or models that do not support DeviceNet.

You can change the display color by setting it, but you cannot switch it based on the judgement results.

\*2 DeviceNet models have a depth of 97 mm.



For the most recent information on models that have been certified for safety standards, refer to your OMRON website.

Refer to *Safety Precautions for All Digital Panel Meters.*

## Model Number Structure

### Model Number Legend

Base Units and Optional Boards can be ordered individually or as sets.

#### Base Units

K3HB-R    
1 5

##### 1. Input Sensor Code

NB: NPN input/voltage pulse input

PB: PNP input

##### 5. Supply Voltage

100-240 VAC: 100 to 240 VAC

24 VAC/VDC: 24 VAC/VDC

#### Optional Boards

##### Sensor Power Supply/Output Boards

K33-  
2

##### Relay/Transistor Output Boards

K34-  
3

##### Event Input Boards

K35-  
4

#### Base Units with Optional Boards

K3HB-R-  
1 2 3 4 5

##### 2. Sensor Power Supply/Output Type Code

None: None

CPA: Relay output (PASS: SPDT) + Sensor power supply (12 VDC±10%, 80 mA) (See note 1.)

L1A: Linear current output (0 to 20 or 4 to 20 mA DC) + Sensor power supply (12 VDC±10%, 80 mA) (See note 2.)

L2A: Linear voltage output (0 to 5, 1 to 5, or 0 to 10 VDC) + Sensor power supply (12 VDC±10%, 80 mA) (See note 2.)

A: Sensor power supply (12 VDC ±10%, 80 mA)

FLK1A: Communications (RS-232C) + Sensor power supply (12 VDC±10%, 80 mA) (See note 2.)

FLK3A: Communications (RS-485) + Sensor power supply (12 VDC±10%, 80 mA) (See note 2.)

**Note: 1.** CPA can be combined with relay outputs only.

**2.** Only one of the following can be used by each Digital Indicator: RS-232C/RS-485 communications, a linear output, or DeviceNet communications.

##### 3. Relay/Transistor Output Type Code

None: None

C1: Relay contact (H/L: SPDT each)

C2: Relay contact (HH/H/LL/L: SPST-NO each)

T1: Transistor (NPN open collector: HH/H/PASS/L/LL)

T2: Transistor (PNP open collector: HH/H/PASS/L/LL)

BCD \*: BCD output + transistor output (NPN open collector: HH/H/PASS/L/LL)

DRT: DeviceNet (See note 2.)

\* A Special BCD Output Cable (sold separately) is required.

##### 4. Event Input Type Code

None: None

1: 5 inputs (M3 terminal blocks), NPN open collector

2 \*: 8 inputs (10-pin MIL connector), NPN open collector

3: 5 inputs (M3 terminal blocks), PNP open collector

4 \*: 8 inputs (10-pin MIL connector), PNP open collector

\* There is no bank selection for "None" and "DeviceNet" types of "Transistor Output Type Code".

**Note:** The following combinations are not possible.

- Communications (FLK) + DeviceNet (DRT)
- Communications (FLK) + BCD output (BCD)
- Linear current/voltage (L) + DeviceNet (DRT)

## Accessories (Sold Separately)

K32-DICN: Special Cable (for event inputs with 8-pin connector)

K32-BCD: Special BCD Output Cable

### Watertight Cover

Model
Y92A-49N

### Rubber Packing

Model
K32-P1

**Note:** Rubber packing is provided with the Controller.

## Specifications

### ■ Ratings

<b>Supply voltage</b>		100 to 240 VAC, 24 VAC/VDC, DeviceNet power supply: 24 VDC
<b>Allowable power supply voltage range</b>		85% to 110% of the rated power supply voltage, DeviceNet power supply: 11 to 25 VDC
<b>Power consumption (See note 1.)</b>		100 to 240 VAC: 18 VA max. (max. load) 24 VAC/DC: 11 VA/7 W max. (max. load)
<b>Current consumption</b>		DeviceNet power supply: 50 mA max. (24 VDC)
<b>Input</b>		No-voltage contact, voltage pulse, open collector
<b>External power supply</b>		12 VDC $\pm$ 10%, 80 mA (models with external power supply only)
<b>Event inputs (See note 2.)</b>	<b>Startup compensation timer input</b>	NPN open collector or no-voltage contact signal ON residual voltage: 2 V max. ON current at 0 $\Omega$ : 4 mA max. Max. applied voltage: 30 VDC max. OFF leakage current: 0.1 mA max.
	<b>Hold input</b>	
	<b>Reset input</b>	
	<b>Bank input</b>	
<b>Output ratings (depends on the model)</b>	<b>Relay output</b>	250 VAC, 30 VDC, 5 A (resistive load) Mechanical life expectancy: 5,000,000 operations, Electrical life expectancy: 100,000 operations
	<b>Transistor output</b>	Maximum load voltage: 24 VDC, Maximum load current: 50 mA, Leakage current: 100 $\mu$ A max.
	<b>Linear output</b>	Linear output 0 to 20 mA DC, 4 to 20 mA DC: Load: 500 $\Omega$ max, Resolution: Approx. 10,000, Output error: $\pm$ 0.5% FS Linear output 0 to 5 VDC, 1 to 5 VDC, 0 to 10 VDC: Load: 5 k $\Omega$ max, Resolution: Approx. 10,000, Output error: $\pm$ 0.5% FS (1 V or less: $\pm$ 0.15 V; no output for 0 V or less)
<b>Display method</b>		Negative LCD (backlit LED) display 7-segment digital display (Character height: PV: 14.2 mm (green/red); SV: 4.9 mm (green))
<b>Main functions</b>		Scaling function, measurement operation selection, averaging, output hysteresis, output OFF delay, output test, teaching, display value selection, display color selection, key protection, bank selection, display refresh period, maximum/minimum hold, reset
<b>Ambient operating temperature</b>		-10 to 55°C (with no icing or condensation)
<b>Ambient operating humidity</b>		25% to 85%
<b>Storage temperature</b>		-25 to 65°C (with no icing or condensation)
<b>Altitude</b>		2,000 m max.
<b>Accessories</b>		Watertight packing, 2 fixtures, terminal cover, unit stickers, instruction manual. DeviceNet models also include a DeviceNet connector (Hirose HR31-5.08P-5SC(01)) and crimp terminals (Hirose HR31-SC-121) (See note 3.)

**Note: 1.** DC power supply models require a control power supply capacity of approximately 1 A per Unit when power is turned ON. Particular attention is required when using two or more DC power supply models. The OMRON S8VS-series DC Power Supply Unit is recommended.

**2.** PNP input types are also available.

**3.** For K3HB-series DeviceNet models, use only the DeviceNet Connector included with the product. The crimp terminals provided are for Thin Cables.

## ■ Characteristics

<b>Display range</b>	-19,999 to 99,999	
<b>Measurement accuracy (at 23±5°C)</b>	Functions F1, F6: ±0.006% rgd ±1 digit (for voltage pulse/open collector sensors) Functions F2 to F5: ±0.02% rgd ±1 digit (for voltage pulse/open collector sensors)	
<b>Measurement range</b>	Functions F1 to F6: 0.5 mHz to 50 kHz (for voltage pulse/open collector sensors)	
<b>Input signals</b>	Contact input (dry contact input) (30-Hz max. with ON/OFF pulse width of 15 ms min.) No contact voltage pulse (50-KHz max. with ON/OFF pulse width of 9 μs min.; ON voltage: 4.5 to 30 V; OFF voltage: -30 to 2 V; input impedance: 10 kΩ) Open collector (50-KHz max. with ON/OFF pulse width of 9 μs min.)	
<b>Connectable sensors</b>	ON residual voltage: 3 V max. OFF leakage current: 1.5 mA max. Load current: Must have a switching capacity of 20 mA or higher. Must be able to properly switch load currents of 5 mA or less.	
<b>Comparative output response time (transistor output)</b>	Functions F1 to F6: 100 ms max. (time until the comparative output is made when there is a forced sudden change in the input signal from 15% to 95% or 95% to 15%.)	
<b>Linear output response time</b>	Functions F1 to F6: 110 ms max. (time until the final analog output value is reached when there is a forced sudden change in the input signal from 15% to 95% or 95% to 15%.)	
<b>Insulation resistance</b>	20 MΩ min. (at 500 VDC)	
<b>Dielectric strength</b>	2,300 VAC for 1 min between external terminals and case	
<b>Noise immunity</b>	100 to 240 VAC models: ±1,500 V at power supply terminals in normal or common mode (waveform with 1-ns rising edge and pulse width of 1 μs/100 ns) 24 VAC/VDC models: ±1,500 V at power supply terminals in normal or common mode (waveform with 1-ns rising edge and pulse width of 1 μs/100 ns)	
<b>Vibration resistance</b>	Frequency: 10 to 55 Hz; Acceleration: 50 m/s <sup>2</sup> , 10 sweeps of 5 min each in X, Y, and Z directions	
<b>Shock resistance</b>	150 m/s <sup>2</sup> (100 m/s <sup>2</sup> for relay outputs) 3 times each in 3 axes, 6 directions	
<b>Weight</b>	Approx. 300 g (Base Unit only)	
<b>Degree of protection</b>	<b>Front panel</b>	Conforms to NEMA 4X for indoor use (equivalent to IP66)
	<b>Rear case</b>	IP20
	<b>Terminals</b>	IP00 + finger protection (VDE0106/100)
<b>Memory protection</b>	EEPROM (non-volatile memory) Number of rewrites: 100,000	
<b>Applicable standards</b>	UL61010-1, CSA C22.2 No.61010-1-04 EN61010-1 (IEC61010-1): Pollution degree 2/Overvoltage category II EN61326-1	
<b>EMC</b>	EMI: EN61326-1 Industrial electromagnetic environment Electromagnetic radiation interference CISPR 11 Group 1, Class A Terminal interference voltage CISPR 11 Group 1, Class A EMS: EN61326-1 Industrial electromagnetic environment Electrostatic Discharge Immunity EN61000-4-2: 4 kV (contact), 8 kV (in air) Radiated Electromagnetic Field Immunity EN61000-4-3: 10 V/m 1 kHz sine wave amplitude modulation (80 MHz to 1 GHz, 1.4 to 2 GHz) Electrical Fast Transient/Burst Noise Immunity EN61000-4-4: 2 kV (power line), 1 kV (I/O signal line) Surge Immunity EN61000-4-5: 1 kV with line (power line), 2 kV with ground (power line) Conducted Disturbance Immunity EN61000-4-6: 3 V (0.15 to 80 MHz) Power Frequency Magnetic Immunity EN61000-4-8: 30 A/m (50 Hz) continuous time Voltage Dips and Interruptions Immunity EN61000-4-11: 0.5 cycle, 0°/180°, 100% (rated voltage)	

# Operation

## ■ Functions (Operating Modes)

### F1 to F6

Functions F1 to F6 provide rpm/circumferential speed and other calculation displays by measuring continuous pulses (frequencies).

Example

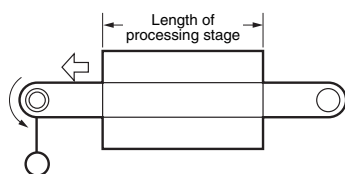

Function name	Function No.
Rpm/circumferential speed	F1
Absolute ratio	F2
Error ratio	F3
Rotational difference	F4
Flow rate ratio	F5
Passing time	F6

F1: Displays rotation (rpm) or circumferential speed for one input.

F2 to F5: Displays the calculation result for two rotation (rpm) speeds.

F6: Displays the passing time calculated from the circumferential speed and the length of the processing stage for one input.

The basic principle used by the Digital Indicator to calculate the rotation speed (rpm) display is to count the ON/OFF time (T) for input sensor or other device inputs using the internal system clock, and then automatically calculate the frequency. This frequency (f) is multiplied by 60 and displayed as the rotation (rpm) speed.

Input sensor or other input pulse ON/OFF time (T) =  Frequency (f) =  $\frac{1}{T}$

- Rotation speed (rpm) =  $f \times 60$
- Circumferential speed = Roll circumference  $\times$  Rotation speed (rpm)
- Passing time =  $\frac{\text{Length of processing stage}}{\text{Circumferential speed}}$

These calculations are automatically made internally and displayed whenever any input pulse is received.

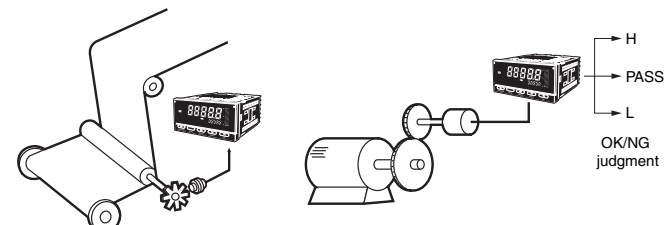
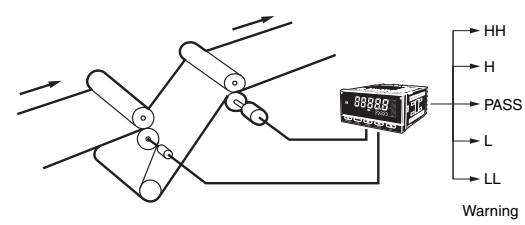
Function	Operation	Operation image (application)																												
F1 Rpm/ circumferential speed/ Instantaneous flowrate	<p>Measures frequency for input A and displays the rotation (rpm) or circumferential speed proportional to the input frequency. Display value <math>D = fa \times 60 \times \alpha</math> fa: Input frequency (Hz)</p> <table border="1"> <thead> <tr> <th>Calculation</th> <th>Display unit</th> <th>Prescale value (<math>\alpha</math>)</th> </tr> </thead> <tbody> <tr> <td rowspan="2">Rotation speed</td> <td>rpm</td> <td>1/N</td> </tr> <tr> <td>rps</td> <td>1/60 N</td> </tr> <tr> <td rowspan="2">Frequency (of input pulse)</td> <td>Hz</td> <td>1/60</td> </tr> <tr> <td>kHz</td> <td>1/60000</td> </tr> <tr> <td rowspan="5">Circumferential speed</td> <td>mm/s</td> <td>1000 <math>\pi d/60</math> N</td> </tr> <tr> <td>cm/s</td> <td>100 <math>\pi d/60</math> N</td> </tr> <tr> <td>m/s</td> <td><math>\pi d/60</math> N</td> </tr> <tr> <td>m/min</td> <td><math>\pi d/N</math></td> </tr> <tr> <td>km/h</td> <td>0.06 <math>\pi d/N</math></td> </tr> <tr> <td rowspan="2">Instantaneous flowrate</td> <td>l/min</td> <td rowspan="2">Check the output specifications of the input device and calculate the prescale value from the following equation: Display value <math>D = fa \times 60 \times \alpha</math></td> </tr> <tr> <td>l/h</td> </tr> </tbody> </table> <p>N = Pulses per rotation <math>\pi d</math> = Circumferential length per rotation (m)</p>	Calculation	Display unit	Prescale value ( $\alpha$ )	Rotation speed	rpm	1/N	rps	1/60 N	Frequency (of input pulse)	Hz	1/60	kHz	1/60000	Circumferential speed	mm/s	1000 $\pi d/60$ N	cm/s	100 $\pi d/60$ N	m/s	$\pi d/60$ N	m/min	$\pi d/N$	km/h	0.06 $\pi d/N$	Instantaneous flowrate	l/min	Check the output specifications of the input device and calculate the prescale value from the following equation: Display value $D = fa \times 60 \times \alpha$	l/h	<p>Measuring roller winding speed      Measuring motor speed (for product testing)</p> 
Calculation	Display unit	Prescale value ( $\alpha$ )																												
Rotation speed	rpm	1/N																												
	rps	1/60 N																												
Frequency (of input pulse)	Hz	1/60																												
	kHz	1/60000																												
Circumferential speed	mm/s	1000 $\pi d/60$ N																												
	cm/s	100 $\pi d/60$ N																												
	m/s	$\pi d/60$ N																												
	m/min	$\pi d/N$																												
	km/h	0.06 $\pi d/N$																												
Instantaneous flowrate	l/min	Check the output specifications of the input device and calculate the prescale value from the following equation: Display value $D = fa \times 60 \times \alpha$																												
	l/h																													
F2 Absolute ratio	<p>Multiples input B divided by input A (<math>\frac{B}{A}</math>) by 100 and displays the ratio as a percentage (%). Display unit: %</p>	<p>Measuring the speed ratio between two rollers</p> 																												

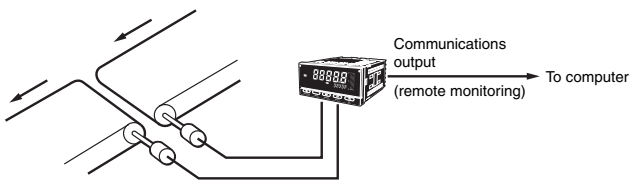
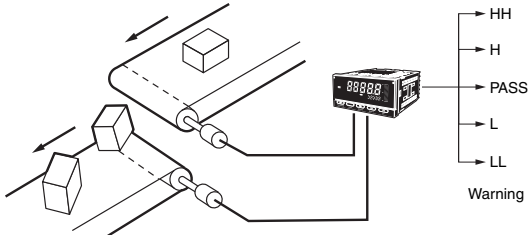
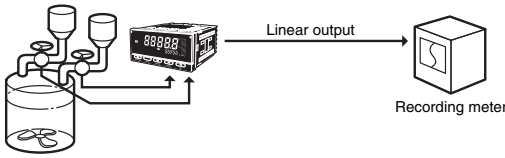
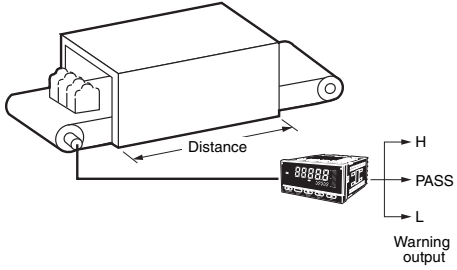
Function	Operation	Operation image (application)						
<p>F3 Error ratio</p>	<p>Multiplies the error between input A and input B <math>(\frac{B}{A} - 1)</math> by 100 and displays the ratio as a percentage (%). Display unit: %</p>	<p>Measuring the line speed error ratio between two conveyors</p> 						
<p>F4 Rotational difference</p>	<p>Displays the difference between input A and input B <math>(B - A)</math> as the rotation (rpm) speed error or circumferential speed error.</p> <p>( Display unit: rpm, rps, rph, Hz, kHz, mm/s, m/s m/min, km/h l/min, l/h, etc. )</p>	<p>Measuring the rotation (rpm)/circumferential speed error (absolute error) between two conveyors</p> 						
<p>F5 Flow rate ratio</p>	<p>Displays the flow rate ratio of B from inputs A and B <math>(\frac{B}{A+B})</math> as a ratio (%). Display unit: %</p>	<p>Monitoring liquid mixture flow rate ratio</p> 						
<p>F6 Passing time</p>	<p>The passing time for the desired distance is displayed by measuring the frequency of input A. Passing time (s) = <math>1/f_a \times \alpha</math> <math>f_a</math>: Input frequency (Hz) Set the prescale value for the desired display unit using the following table for reference.</p> <table border="1" data-bbox="248 1234 751 1301"> <thead> <tr> <th>Calculation</th> <th>Display unit</th> <th>Prescale value (<math>\alpha</math>)</th> </tr> </thead> <tbody> <tr> <td>Passing time</td> <td>s</td> <td><math>L/(\pi d/N)</math></td> </tr> </tbody> </table> <p>N = Pulses per rotation <math>\pi d</math> = Circumferential length per rotation (m) L = Length of process (m)</p> <p>( Display unit: Seconds (s), minutes (min), hours/minutes/seconds (h.min.s), minutes/seconds/tenths of seconds (min.s.1/10s), etc. )</p>	Calculation	Display unit	Prescale value ( $\alpha$ )	Passing time	s	$L/(\pi d/N)$	<p>Displaying the passing time for a conveyor line</p> 
Calculation	Display unit	Prescale value ( $\alpha$ )						
Passing time	s	$L/(\pi d/N)$						

## ■ What Is Prescaling?

To make calculations using the input pulse to display rotation (rpm) or circumferential speed, the number of pulses per rotation or the length of the circumference must be multiplied by a certain coefficient. This coefficient is called the prescale value.

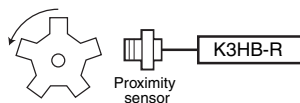

Rotation speed (rpm) =  $f \times 60 \times a$

f: Input pulse frequency (No. of pulses per second)

a: Prescale value

If there are 5 pulses per rotation, then

$a = 1/5 (= 0.2 = 2 \times 10^{-1})$

and an accurate rotation speed (rpm) can be calculated.

The actual setting is X = 2.0000 (mantissa) and Y =  $10^{-1}$  (exponent).

## ■ What Is the Auto-zero Function?

(Set this function before using the Digital Indicator.)

If a function  $F \uparrow$  to  $F \downarrow$  is set, the frequency can be force-set to zero if there is no input pulse for a set period. This period is called the auto-zero time. Set the auto-zero time to slightly longer than the longest input pulse interval. (The display will not easily return to zero if the auto-zero time is too long or left at the default setting.)

### Time Unit Settings

Setting	Meaning
$\bar{0}FF$	Invalid
$5\bar{L}R\bar{L}$	Prescale value menu setting
$\bar{n}\bar{L}\bar{n}$	Minute display
$H.\bar{n}\bar{n}.SS$	h.mm.ss display
$\bar{n}\bar{n}.SS.d$	mm.ss.d display (d = tenths of a second)

**Note:** Time unit can be set only when passing time (F6) is selected.

### Input Type Setting

	NO: Voltage pulse high	NC: Voltage pulse low
No-contact or voltage pulse input	$\bar{0}\bar{0}$	$\bar{0}\bar{1}$
Contact	$\bar{1}\bar{0}$	$\bar{1}\bar{1}$

**Note:** Set to  $\bar{1}\bar{0}$  or  $\bar{1}\bar{1}$  when there is a large variation in the display. The largest measurement range is 30 Hz.

# Common Specifications

## Event Input Ratings

<b>K3HB-R</b>	S-TMR, HOLD, RESET, BANK1, BANK2, BANK4
<b>Contact</b>	ON: 1 k $\Omega$ max., OFF: 100 k $\Omega$ min.
<b>No-contact</b>	ON residual voltage: 2 V max. OFF leakage current: 0.1 mA max. Load current: 4 mA max. Maximum applied voltage: 30 VDC max.

## Output Ratings

### Contact Output

Item	Resistive loads (250 VAC, $\cos\phi=1$ ; 30 VDC, L/R=0 ms)	Inductive loads (250 VAC, closed circuit, $\cos\phi=0.4$ ; 30 VDC, L/R=7 ms)
<b>Rated load</b>	5 A at 250 VAC 5 A at 30 VDC	1 A at 250 VAC 1 A at 30 VDC
<b>Mechanical life expectancy</b>	5,000,000 operations	
<b>Electrical life expectancy</b>	100,000 operations	

### Transistor Outputs

<b>Maximum load voltage</b>	24 VDC
<b>Maximum load current</b>	50 mA
<b>Leakage current</b>	100 $\mu$ A max.

### Linear Output

Item	Outputs	0 to 20 mA	4 to 20 mA	0 to 5 V	1 to 5 V	0 to 10 V
<b>Allowable load impedance</b>		500 $\Omega$ max.		5 k $\Omega$ min.		
<b>Resolution</b>		Approx. 10,000				
<b>Output error</b>		$\pm 0.5\%$ FS		$\pm 0.5\%$ FS ( $\pm 0.15$ V for 1 V or less and no output for 0 V)		

### Serial Communications Output

Item	Type	RS-232C, RS-485
<b>Communications method</b>		Half duplex
<b>Synchronization method</b>		Start-stop synchronization (asynchronous)
<b>Baud rate</b>		9600/19200/38400 bps
<b>Transmission code</b>		ASCII
<b>Data length</b>		7 bits or 8 bits
<b>Stop bit length</b>		2 bits or 1 bit
<b>Error detection</b>		Vertical parity and FCS
<b>Parity check</b>		Odd, even

### BCD Output I/O Ratings (Input Signal Logic: Negative)

I/O signal name		Item	Rating
<b>Inputs</b>	REQUEST	Input signal	No-voltage contact input
	HOLD	Input current for no-voltage input	10 mA
	MAX MIN RESET	Signal level	ON voltage: 1.5 V max. OFF voltage: 3 V min.
<b>Outputs</b>	DATA	Maximum load voltage	24 VDC
	POLARITY	Maximum load current	10 mA
	OVER	Leakage current	100 $\mu$ A max.
	DATA VALID	Maximum load voltage	24 VDC
	RUN	Maximum load current	50 mA
		Leakage current	100 $\mu$ A max.

Refer to the *K3HB Communications User's Manual* (Cat. No. N129) for details on serial and DeviceNet communications.

## DeviceNet Communications

<b>Communications protocol</b>		Conforms to DeviceNet																		
<b>Supported communications</b>	<b>Remote I/O communications</b>	Master-Slave connection (polling, bit-strobe, COS, cyclic) Conforms to DeviceNet communications standards.																		
	<b>I/O allocations</b>	Allocate any I/O data using the Configurator. Allocate any data, such as DeviceNet-specific parameters and variable area for Digital Indicators. Input area: 2 blocks, 60 words max. Output area: 1 block, 29 words max. (The first word in the area is always allocated for the Output Execution Enabled Flags.)																		
	<b>Message communications</b>	Explicit message communications CompoWay/F communications commands can be executed (using explicit message communications)																		
<b>Connection methods</b>		Combination of multi-drop and T-branch connections (for trunk and drop lines)																		
<b>Baud rate</b>		DeviceNet: 500, 250, or 125 Kbps (automatic follow-up)																		
<b>Communications media</b>		Special 5-wire cable (2 signal lines, 2 power supply lines, 1 shield line)																		
<b>Communications distance</b>		<table border="1"> <thead> <tr> <th>Baud rate</th> <th>Network length (max.)</th> <th>Drop line length (max.)</th> <th>Total drop line length (max.)</th> </tr> </thead> <tbody> <tr> <td>500 Kbps</td> <td>100 m max. (100 m max.)</td> <td>6 m max.</td> <td>39 m max.</td> </tr> <tr> <td>250 Kbps</td> <td>100 m max. (250 m max.)</td> <td>6 m max.</td> <td>78 m max.</td> </tr> <tr> <td>125 Kbps</td> <td>100 m max. (500 m max.)</td> <td>6 m max.</td> <td>156 m max.</td> </tr> </tbody> </table> <p>The values in parentheses are for Thick Cable.</p>			Baud rate	Network length (max.)	Drop line length (max.)	Total drop line length (max.)	500 Kbps	100 m max. (100 m max.)	6 m max.	39 m max.	250 Kbps	100 m max. (250 m max.)	6 m max.	78 m max.	125 Kbps	100 m max. (500 m max.)	6 m max.	156 m max.
Baud rate	Network length (max.)	Drop line length (max.)	Total drop line length (max.)																	
500 Kbps	100 m max. (100 m max.)	6 m max.	39 m max.																	
250 Kbps	100 m max. (250 m max.)	6 m max.	78 m max.																	
125 Kbps	100 m max. (500 m max.)	6 m max.	156 m max.																	
<b>Communications power supply</b>		24-VDC DeviceNet power supply																		
<b>Allowable voltage fluctuation range</b>		11 to 25-VDC DeviceNet power supply																		
<b>Current consumption</b>		50 mA max. (24 VDC)																		
<b>Maximum number of nodes</b>		64 (DeviceNet Configurator is counted as one node when connected.)																		
<b>Maximum number of slaves</b>		63																		
<b>Error control checks</b>		CRC errors																		
<b>DeviceNet power supply</b>		Supplied from DeviceNet communications connector																		



# Connections

## External Connection Diagrams

### Terminal Arrangements

Note: Refer to *Internal Block Diagram* on page 11 for information on isolation.

#### A Operating Power Supply

100 to 240 VAC  
24 VAC/VDC

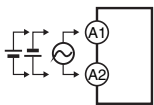

\*Check the required power supply type.

#### B Sensor Power Supply/Output

Sensor power supply + PASS output

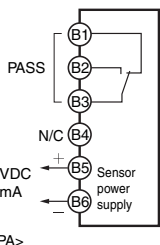

<CPA>

Sensor power supply + linear output

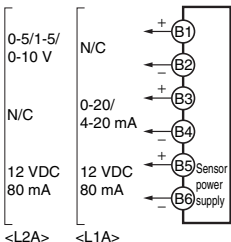

<L2A> <L1A>

Sensor power supply

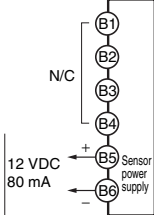

<A>

Sensor power supply + communications

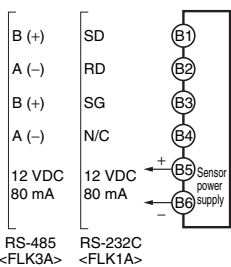

RS-485 <FLK3A> RS-232C <FLK1A>

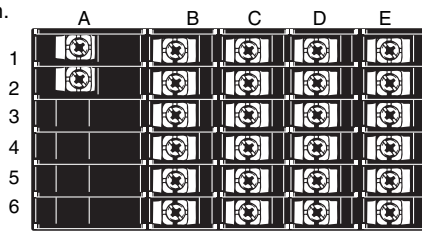

#### C Relays, Transistors, BCD and DeviceNet

Relay Outputs <C1>

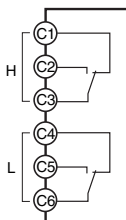

Relay Outputs <C2>

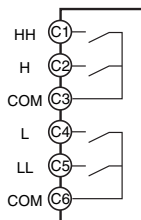

Transistor Outputs <T1> <T2>

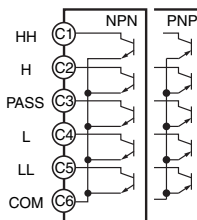

DeviceNet Connector (Included) <DRT>

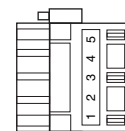

- 1: V- (Power supply cable: Black)
  - 2: CAN L (Communications cable: Blue)
  - 3: Shield
  - 4: CAN H (Communications cable: White)
  - 5: V+ (Power supply cable: Red)
- Applicable Connector:  
HR31-5.08P-5SC (01)  
(HIROSE ELECTRIC CO., LTD.)  
\* Attach the provided crimp terminals.

BCD (NPN Open Collector): <BCD>  
Applicable Connector (Sold separately)  
K32-BCD (OMRON)  
(HDR-E50MAG1 with 0.3-m cable)

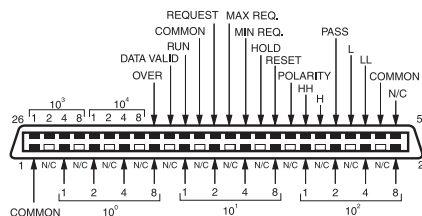

The BCD COMMON is shared.  
The pins indicated in the above diagram as blank (white) boxes have been removed.

Only one of the following can be used for each Digital Indicator: communications, BCD, or DeviceNet.

Contact Outputs

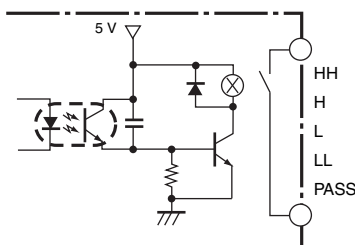

Transistor Outputs (NPN Open Collector)

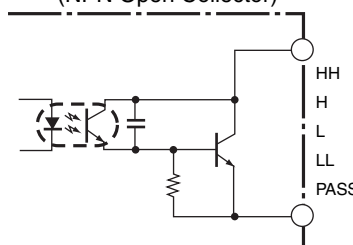

#### Safety Standards Conformance

- Always use a EN/IEC-compliant power supply with reinforced insulation or double insulation for the DeviceNet power supply.
- The product must be used indoors for the above applicable standards to apply.

**E Pulse Inputs**

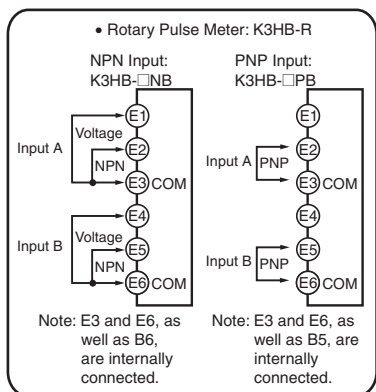

**NPN Input Model**

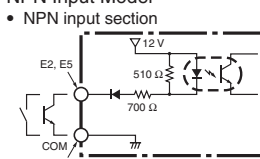

**PNP Input Model**

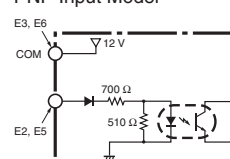

<b>Connectable Sensors</b>	ON residual voltage: 3 V
	OFF leakage current: 1.5 mA max.

**Voltage pulse input section**

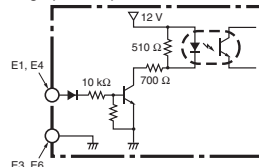

Note: A 2-wire DC sensor can also be connected. Check the ratings and characteristics tables, however, for the connection conditions.

<b>Connectable Sensors</b>	ON voltage: 4.5 to 30 V
	OFF voltage: -30 to 2 V

**D Event Inputs**

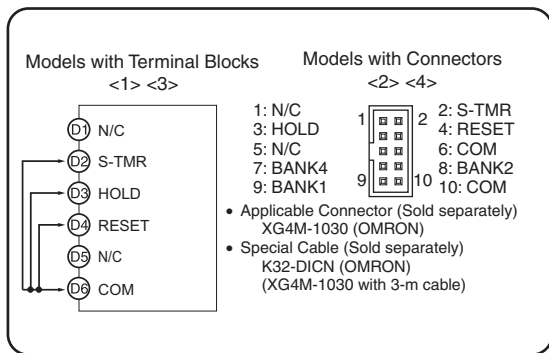

- Use terminal pin D6 as the common terminal.
  - Use NPN open collector or no-voltage contacts for event input.
- PNP types are also available.

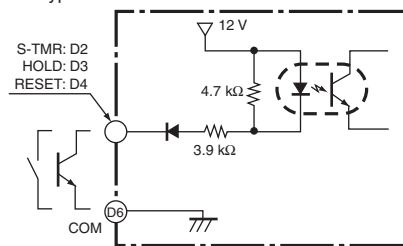

**BCD Output Cable**

Model	Shape	Pin arrangement
K32-BCD	<p>K3HB end: 38 mm</p> <p>Connected device end (PLC, display device, etc.): 46.5 mm</p> <p>Cable length: 300 mm</p> <p>Cover: HDR-E50LPA5 (manufactured by Honda Tsushin Co., Ltd.)</p> <p>Connector: HDR-E50MAG1 (manufactured by Honda Tsushin Co., Ltd.)</p> <p>D-sub connector (37-pin female)</p> <p>Cover: 17JE-37H-1A (manufactured by DDK)</p> <p>Connector: Equivalent to 17JE-13370-02 (manufactured by DDK)</p> <p>Stud: 17L-002A (manufactured by DDK)</p>	<p>COMMON</p> <p>10<sup>0</sup>: 1, 2, 4, 8</p> <p>10<sup>1</sup>: 1, 2, 4, 8</p> <p>10<sup>2</sup>: 1, 2, 4, 8</p> <p>10<sup>3</sup>: 1, 2, 4, 8</p> <p>10<sup>4</sup>: 1, 2, 4, 8</p> <p>Signal names: OVER, DATA VALID, RUN, COMMON, REQUEST, MAX REQ., MIN REQ., HOLD, RESET, POLARITY, HH, H, PASS, L, LL, COMMON</p>

Note: The BCD Output Cable has a D-sub plug. Cover: 17JE-37H-1A (manufactured by DDK); Connector: equivalent to 17JE-23370-02 (D1) (manufactured by DDK)

**Special Cable (for Event Inputs with 8-pin Connector)**

Model	Appearance	Wiring																						
K32-DICN	<p>Cable marking (3 m)</p>	<table border="1"> <thead> <tr> <th>Pin No.</th> <th>Signal name</th> </tr> </thead> <tbody> <tr><td>1</td><td>N/C</td></tr> <tr><td>2</td><td>S-TMR</td></tr> <tr><td>3</td><td>HOLD</td></tr> <tr><td>4</td><td>RESET</td></tr> <tr><td>5</td><td>N/C</td></tr> <tr><td>6</td><td>COM</td></tr> <tr><td>7</td><td>BANK4</td></tr> <tr><td>8</td><td>BANK2</td></tr> <tr><td>9</td><td>BANK1</td></tr> <tr><td>10</td><td>COM</td></tr> </tbody> </table>	Pin No.	Signal name	1	N/C	2	S-TMR	3	HOLD	4	RESET	5	N/C	6	COM	7	BANK4	8	BANK2	9	BANK1	10	COM
Pin No.	Signal name																							
1	N/C																							
2	S-TMR																							
3	HOLD																							
4	RESET																							
5	N/C																							
6	COM																							
7	BANK4																							
8	BANK2																							
9	BANK1																							
10	COM																							

## Derating Curve for Sensor Power Supply (Reference Values)

For 12V

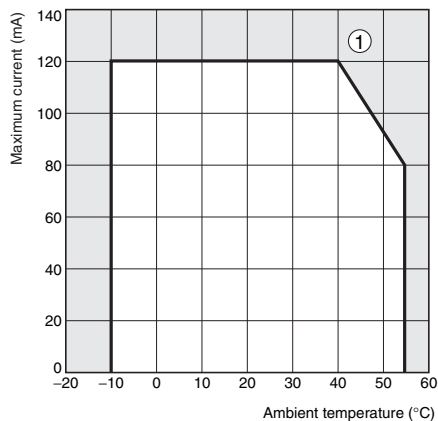

**Note: 1.** The above values were obtained under test conditions with the standard mounting. The derating curve will vary with the mounting conditions, so be sure to adjust accordingly.

**2.** Internal components may be deteriorated or damaged. Do not use the Digital Indicator outside of the derating range (i.e., do not use it in the area labeled ①, above).

## Internal Block Diagram

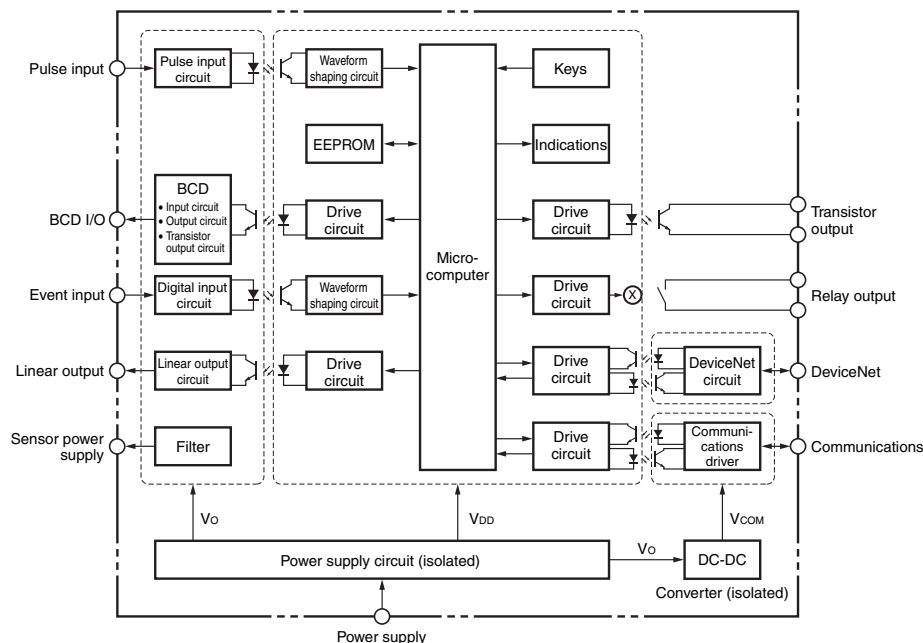

## BCD Output Timing Chart

A REQUEST signal from a Programmable Controller or other external device is required to read BCD data.

### Single Sampling Data Output

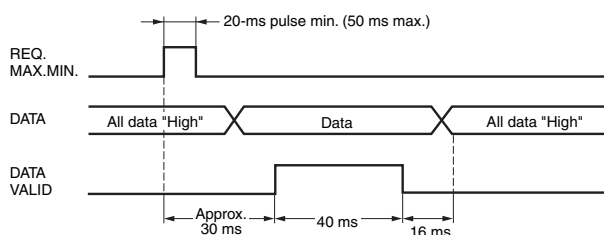

The data is set in approximately 30 ms from the rising edge of the REQUEST signal and the DATA VALID signal is output. When reading the data from a Programmable Controller, start reading the data when the DATA VALID signal turns ON. The DATA VALID signal will turn OFF 40 ms later, and the data will turn OFF 16 ms after that.

- The K3HB BCD output model has an open collector output, so wired OR connection is possible

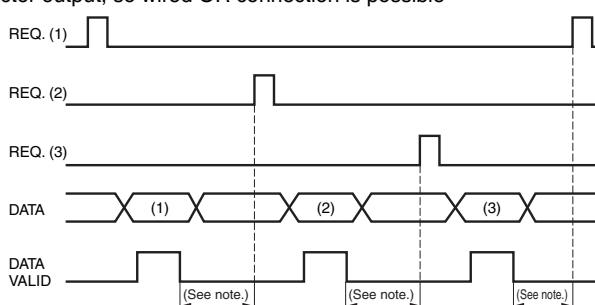
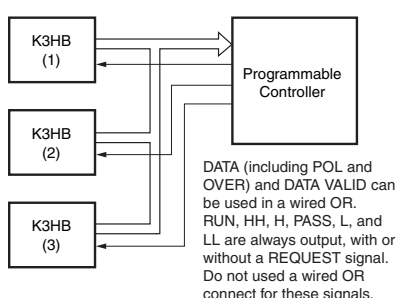

**Note:** Leave 20 ms min. between DATA VALID turning OFF and the REQUEST signal.

### Continuous Data Output

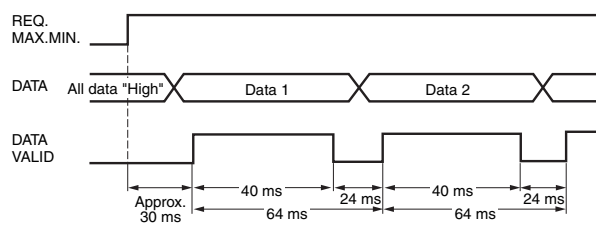

Measurement data is output every 64 ms while the REQUEST signal remains ON.

**Note:** If HOLD is executed when switching between data 1 and data 2, either data 1 or data 2 is output depending on the timing of the hold signal. The data will not go LOW.

### Programmable Controller Connection Example

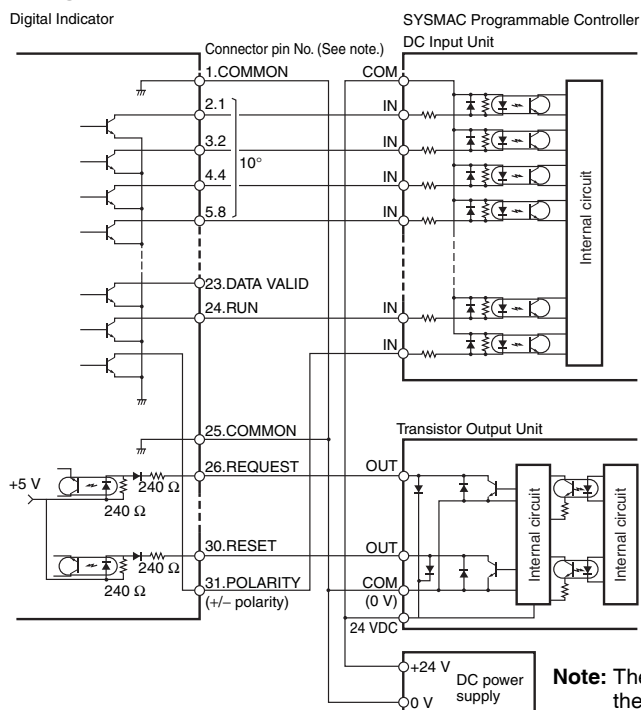

### Display Unit Connection Example

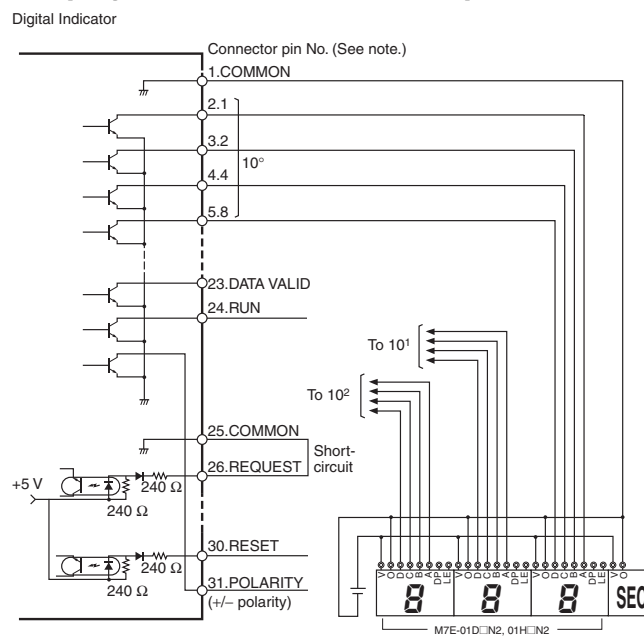

**Note:** The BCD output connector pin number is the D-sub connector pin number when the BCD Output Cable (sold separately) is connected. This number differs from the pin number for the Digital Indicator narrow pitch connector (manufactured by Honda Tsushin Kogyo Co., Ltd.).

\*M7E series were discontinued at the end of March, 2020.

Refer to the following User's Manual for application precautions and other information required when using the Digital Indicator:  
K3HB-R/P/C Digital Indicator User's Manual (Cat. No. N136)  
The manual can be downloaded from the following site in PDF format: OMRON Industrial Web <http://www.fa.omron.co.jp>

## Component Names and Functions

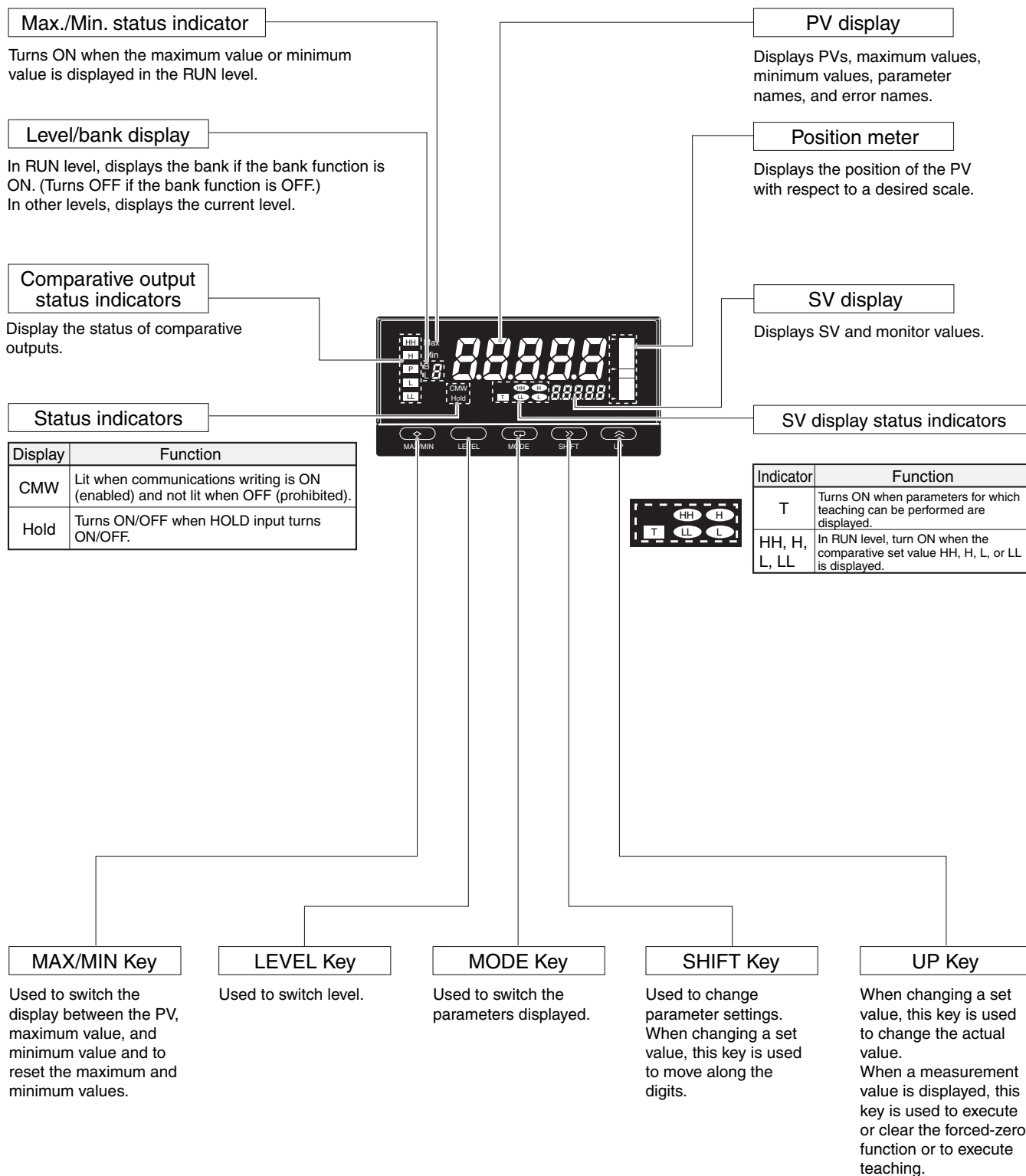

## Dimensions

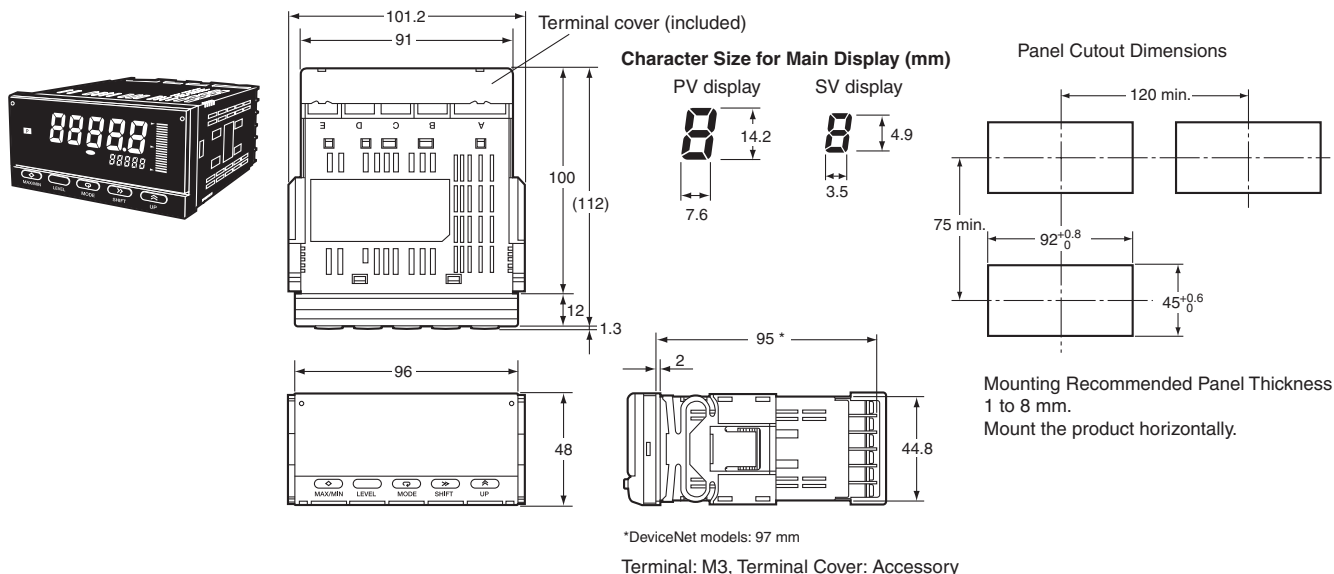

## Wiring Precautions

- For terminal blocks, use the crimp terminals suitable for M3 screws.
- Tighten the terminal screws to the recommended tightening torque of approx. 0.5 N·m.
- To prevent inductive noise, separate the wiring for signal lines from that for power lines.

## Wiring

- Use the crimp terminals suitable for M3 screws shown below.

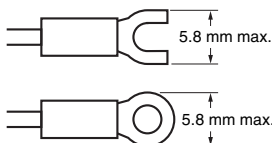

## Unit Stickers (included)

- No unit stickers are attached to the Digital Indicator.
- Select the appropriate units from the unit sticker sheets provided.

V	A	V	A	%	J	Pa	Ω
s	/	N	m	W	°C	m <sup>3</sup>	k
°F	g	min	mm	rpm			
VA	mV	mA	Hz				
m/min	OMRON						
OUT	OUT						

**Note:** For measurements for commercial purposes, be sure to use the unit required by any applicable laws or regulations.

## Mounting Method

1. Insert the K3HB into the mounting cutout in the panel.
2. Insert watertight packing around the Unit to make the mounting watertight.

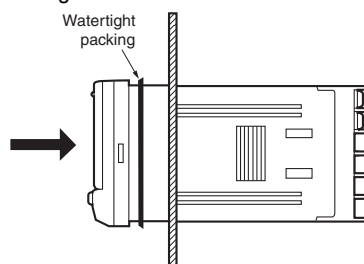

3. Insert the fixture into the grooves on the left and right sides of the rear case and push until it reaches the panel and is fixed in place.

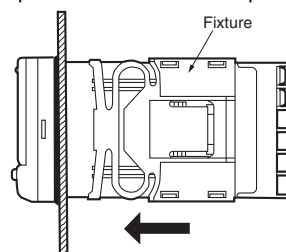

## LCD Field of Vision

The K3HB is designed to have the best visibility at the angles shown in the following diagram.

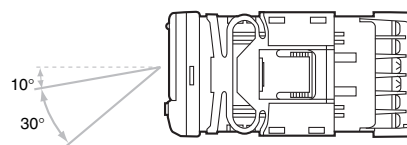

## Watertight Cover

Y92A-49N

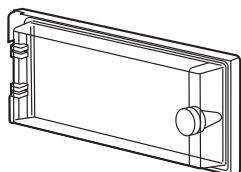

## Rubber Packing

K32-P1

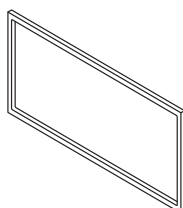

If the rubber packing is lost or damaged, it can be ordered using the following model number: K32-P1.

(Depending on the operating environment, deterioration, contraction, or hardening of the rubber packing may occur and so, in order to ensure the level of waterproofing specified in NEMA4, periodic replacement is recommended.)

**Note:** Rubber packing is provided with the Controller.

# Main Functions

## ■ Main Functions and Features

### Measurement

#### Function **FUNC**

The K3HB-R has the following six functions for receiving and displaying input pulses.

F1: Rotation (rpm)/circumferential speed

F2: Absolute ratio

F3: Error ratio

F4: Rotational difference

F5: Flow rate ratio

F6: Passing time

The K3HB-P has the following six functions for receiving and displaying input pulses.

F1: Passing speed

F2: Cycle

F3: Time difference

F4: Time band

F5: Measuring length

F6: Interval

The K3HB-C has the following three functions for receiving and displaying input pulses.

F1: Individual inputs

F2: Phase differential inputs

F3: Pulse counting input

### Filters

#### Average Processing **AVG-t, AVG-n**

Average processing of input signals with extreme changes or noise smooths out the display and makes control stable.

#### Input Types **IN-tA, IN-tb**

Specify the types of sensor connected to input A and input B.

### Input Compensation

#### Auto-zero Times **At-zA, At-zb**

The frequency is forced to zero if there is no pulse input for a set period.

### Key Operations

#### Teaching

The present measurement value can be used as a scaling value.

#### Key Protection

Key protection restricts level or parameter changes using the keys to prevent unintentional key operations and malfunctions.

## Outputs

### Comparative Output Pattern **ōūē-P**

Standard, zone, and level comparative output patterns can be selected for comparative outputs.

### Hysteresis **HY5**

Prevents comparative outputs from chattering when the measurement value fluctuates slightly near the set value.

### Output Refresh Stop **ō-SēP**

Holds the output status when a comparative result output other than PASS turns ON.

### PASS Output Change **PASS**

Comparative results other than PASS can be output from the PASS output terminal.

### Output OFF Delay **ōFF-d**

Delays turning OFF comparatives for a set period. This can be used to provide sufficient time to read the comparative output ON status when the comparative result changes at short intervals.

### Shot Output **SHōē**

Turns ON the comparative output for a specific time.

### Output Logic **ōūē-n**

Reverses the output logic of comparative results.

### Startup Compensation Timer **S-tñr**

Measurements can be stopped for a set time using an external input.

### Output Test **tēSē**

Output operation can be checked without using actual input signals by using the keys to set a test measurement value.

### Linear Outputs **LSEēē, LSEēū, LSEēH, LSEēL**

A current or voltage proportional to the change in the measurement value can be output.

### Standby Sequence **SēdbY**

The comparison outputs can be kept OFF until the measurement value enters the PASS range.

## Display

### Display Value Selection **dēSP**

The display value can be set to the present value, the maximum value, or the minimum value.

### Display Color Selection **ēōēōr**

The present value display color can be set to green or red. The color of the present value can also be switched according to the comparative output.

### Display Refresh Period **dēEF**

When the input changes rapidly, the display refresh period can be lengthened to control flickering and make the display easier to read.

### Position Meter **PōS-ē, PōS-H, PōS-L**

The present measurement value can be displayed as a position in relation to the scaling width on a 20-gradation position meter.

### Prescale **P5Rū, P5RY, P5bū, P5bY**

The input signal can be converted and displayed as any value.

### Comparative Set Value Display **SūdSP**

Select whether or not to display the comparative value during operation.

### Display auto-return **rēē**

Automatically returns the display to RUN level when there are no key operations (e.g., max./min. switching, bank settings using keys).

## Other

### Max./Min. Hold

Holds the maximum and minimum measurement values.

### Bank Selection **bnP-ē**

Switch between 8 comparative value banks using the keys on the front panel or external inputs. A set of set comparative values can be selected as a group.

### Bank Copy **ēōPY**

Any bank settings can be copied to all banks.

ALL DIMENSIONS SHOWN ARE IN MILLIMETERS.

To convert millimeters into inches, multiply by 0.03937. To convert grams into ounces, multiply by 0.03527.

In the interest of product improvement, specifications are subject to change without notice.



## Terms and Conditions Agreement

### Read and understand this catalog.

Please read and understand this catalog before purchasing the products. Please consult your OMRON representative if you have any questions or comments.

### Warranties.

(a) Exclusive Warranty. Omron's exclusive warranty is that the Products will be free from defects in materials and workmanship for a period of twelve months from the date of sale by Omron (or such other period expressed in writing by Omron). Omron disclaims all other warranties, express or implied.

(b) Limitations. OMRON MAKES NO WARRANTY OR REPRESENTATION, EXPRESS OR IMPLIED, ABOUT NON-INFRINGEMENT, MERCHANTABILITY OR FITNESS FOR A PARTICULAR PURPOSE OF THE PRODUCTS. BUYER ACKNOWLEDGES THAT IT ALONE HAS DETERMINED THAT THE PRODUCTS WILL SUITABLY MEET THE REQUIREMENTS OF THEIR INTENDED USE.

Omron further disclaims all warranties and responsibility of any type for claims or expenses based on infringement by the Products or otherwise of any intellectual property right. (c) Buyer Remedy. Omron's sole obligation hereunder shall be, at Omron's election, to (i) replace (in the form originally shipped with Buyer responsible for labor charges for removal or replacement thereof) the non-complying Product, (ii) repair the non-complying Product, or (iii) repay or credit Buyer an amount equal to the purchase price of the non-complying Product; provided that in no event shall Omron be responsible for warranty, repair, indemnity or any other claims or expenses regarding the Products unless Omron's analysis confirms that the Products were properly handled, stored, installed and maintained and not subject to contamination, abuse, misuse or inappropriate modification. Return of any Products by Buyer must be approved in writing by Omron before shipment. Omron Companies shall not be liable for the suitability or unsuitability or the results from the use of Products in combination with any electrical or electronic components, circuits, system assemblies or any other materials or substances or environments. Any advice, recommendations or information given orally or in writing, are not to be construed as an amendment or addition to the above warranty.

See <http://www.omron.com/global/> or contact your Omron representative for published information.

### Limitation on Liability: Etc.

OMRON COMPANIES SHALL NOT BE LIABLE FOR SPECIAL, INDIRECT, INCIDENTAL, OR CONSEQUENTIAL DAMAGES, LOSS OF PROFITS OR PRODUCTION OR COMMERCIAL LOSS IN ANY WAY CONNECTED WITH THE PRODUCTS, WHETHER SUCH CLAIM IS BASED IN CONTRACT, WARRANTY, NEGLIGENCE OR STRICT LIABILITY.

Further, in no event shall liability of Omron Companies exceed the individual price of the Product on which liability is asserted.

### Suitability of Use.

Omron Companies shall not be responsible for conformity with any standards, codes or regulations which apply to the combination of the Product in the Buyer's application or use of the Product. At Buyer's request, Omron will provide applicable third party certification documents identifying ratings and limitations of use which apply to the Product. This information by itself is not sufficient for a complete determination of the suitability of the Product in combination with the end product, machine, system, or other application or use. Buyer shall be solely responsible for determining appropriateness of the particular Product with respect to Buyer's application, product or system. Buyer shall take application responsibility in all cases.

NEVER USE THE PRODUCT FOR AN APPLICATION INVOLVING SERIOUS RISK TO LIFE OR PROPERTY OR IN LARGE QUANTITIES WITHOUT ENSURING THAT THE SYSTEM AS A WHOLE HAS BEEN DESIGNED TO ADDRESS THE RISKS, AND THAT THE OMRON PRODUCT(S) IS PROPERLY RATED AND INSTALLED FOR THE INTENDED USE WITHIN THE OVERALL EQUIPMENT OR SYSTEM.

### Programmable Products.

Omron Companies shall not be responsible for the user's programming of a programmable Product, or any consequence thereof.

### Performance Data.

Data presented in Omron Company websites, catalogs and other materials is provided as a guide for the user in determining suitability and does not constitute a warranty. It may represent the result of Omron's test conditions, and the user must correlate it to actual application requirements. Actual performance is subject to the Omron's Warranty and Limitations of Liability.

### Change in Specifications.

Product specifications and accessories may be changed at any time based on improvements and other reasons. It is our practice to change part numbers when published ratings or features are changed, or when significant construction changes are made. However, some specifications of the Product may be changed without any notice. When in doubt, special part numbers may be assigned to fix or establish key specifications for your application. Please consult with your Omron's representative at any time to confirm actual specifications of purchased Product.

### Errors and Omissions.

Information presented by Omron Companies has been checked and is believed to be accurate; however, no responsibility is assumed for clerical, typographical or proofreading errors or omissions.