

Solid-state Timer

H3Y

Miniature Timer Compatible with the MY Relay

- Large transparent time-setting knob facilitates time setting. Flat-blade and Phillips screwdrivers can also be used for time setting.
- Approved by UL and CSA.
- Pin configuration compatible with MY Power Relay.
- LED indication for power and output statuses.
- Conforms to EMC standards.
- High repeat accuracy.



Ordering Information

| Operation/resetting system | Time-limit contact | Time ranges | Supply voltage | Model |
|-------------------------------------|--------------------|-----------------|----------------|---|
| | | | | Surface /DIN-track mounting (with socket) |
| Time-limit operation/self-resetting | DPDT | 0.1 s to 30 min | 110 VAC | H3Y-2 |
| | | | 220 VAC | |
| | | | 24 VDC | |
| | 4PDT | | 110 VAC | H3Y-4 |
| | | | 220 VAC | |
| | | | 24 VDC | |

Note: Specify the model number, supply voltage, and rated time when ordering.

Ex. H3Y-2 110 VAC 1 s
 Supply voltage Rated time

Accessories

| Track mounted socket (see note) | Back connecting socket | | |
|---------------------------------|------------------------|--------------------|-------------|
| | Solder terminal | Wire-wrap terminal | PC terminal |
| PYF08A, PYF08A-N, PYF08A-E | PY08 | PY08QN(2) | PY08-02 |
| PYF14A, PYF14A-N, PYF14A-E | PY14 | PY14QN(2) | PY14-02 |

Note: Track mounted socket can be used as a front connecting socket.

Specifications

Time Ranges

| Rated time | 1 s | 5 s | 10 s | 30 s | 60 s | 3 min | 30 min |
|--------------------|------------|------------|-------------|-------------|-------------|--------------|---------------|
| Time setting range | 0.1 to 1 s | 0.2 to 5 s | 0.5 to 10 s | 1.0 to 30 s | 2.0 to 60 s | 0.1 to 3 min | 1.0 to 30 min |

■ Ratings

| Item | H3Y-2/H3Y-4 |
|-------------------------|--|
| Rated supply voltage | 110, 220 VAC (50/60 Hz), 24 VDC (see note) |
| Operating voltage range | 85% to 110% of rated supply voltage |
| Power consumption | 100 VAC: Relay ON: 1.5 VA (1.3 W) Relay OFF: 0.8 VA (0.5 W) 200 VAC: Relay ON: 1.8 VA (1.5 W) Relay OFF: 1.2 VA (0.9 W) 24 VDC: Relay ON: 0.9 W Relay OFF: 0.07 W |
| Control outputs | H3Y-2: 5 A at 250 VAC, resistive load ($\cos\phi = 1$) H3Y-4: 3 A at 250 VAC, resistive load ($\cos\phi = 1$) |

Note: With DC ratings, single-phase full-wave rectified power sources may be used.

■ Characteristics

| | |
|----------------------------|---|
| Accuracy of operating time | ±2% max. |
| Setting error | ±10% (max. time division at rated voltage and room temperature) |
| Reset time | 0.1 s max. |
| Influence of voltage | ±2% max. |
| Influence of temperature | ±5% max. |
| Insulation resistance | 100 MΩ min. (at 500 VDC) |
| Dielectric strength | 2,000 VAC, 50/60 Hz for 1 min (between current-carrying terminals and exposed non-current-carrying metal parts) (see note) 2,000 VAC, 50/60 Hz for 1 min (between operating power circuit and control output) (see note) 2,000 VAC, 50/60 Hz for 1 min (between different pole contacts; 2-pole model) (see note) 1,500 VAC, 50/60 Hz for 1 min (between different pole contacts; 4-pole model) 1,000 VAC, 50/60 Hz for 1 min (between non-continuous contacts) |
| Vibration resistance | Destruction: 10 to 55 Hz with 1.0-mm double amplitude Malfunction: 10 to 55 Hz with 1.0-mm double amplitude |
| Shock resistance | Destruction: 1,000 m/s ² (approx. 100G) Malfunction: 100 m/s ² (approx. 10G) |
| Ambient temperature | Operating: -10°C to 50°C (with no icing) |
| Ambient humidity | Operating: 35% to 85% |
| Life expectancy | Mechanical: 10,000,000 operations min. (under no load at 1,800 operations/h) Electrical: H3Y-2: 500,000 operations min. (5 A at 250 VAC, resistive load at 1800 operations/h) H3Y-4: 200,000 operations min. (3 A at 250 VAC, resistive load at 1800 operations/h) |
| EMC | Emission Enclosure: EN55011 Group 1 class A Emission AC Mains: EN55011 Group 1 class A Immunity ESD: IEC801-2: 4 kV contact discharge (level 2) 4 kV air discharge (level 2) Immunity RF-interference: ENV50140: 10 V/m (80 MHz to 1 GHz) (level 3) Immunity Conducted Disturbance: ENV50141: 10 V (0.15 to 80 MHz) (level 3) Immunity Burst: IEC801-4: 2 kV power-line (level 3) 2 kV I/O signal-line (level 4) |
| Approved standards | UL (File No. E41515), CSA (File No. LR22310) Conforms to EN50081-2, EN50082-2 |
| Weight | Approx. 50 g |

Note: Terminal screw sections are excluded.

Engineering Data

H3Y-2

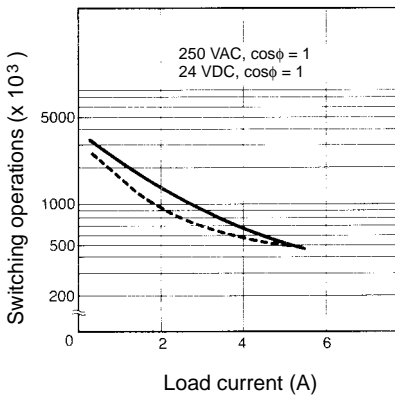

H3Y-2

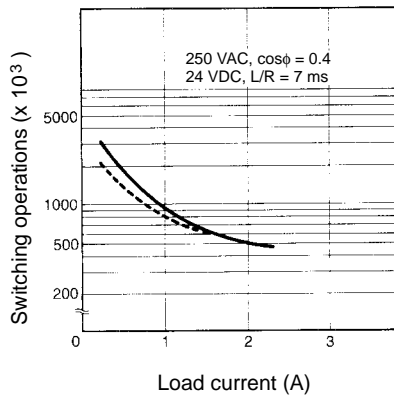

Reference: A maximum current of 0.6 A can be switched at 125 VDC ($\cos\phi = 1$). Maximum current of 0.2 A can be switched if L/R is 7 ms. In both cases, a life of 100,000 operations can be expected. The minimum applicable load is 1 mA at 5 VDC (P reference value).

H3Y-4

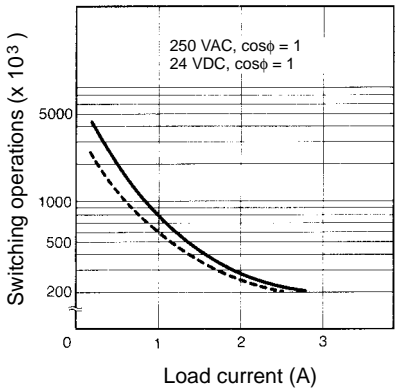

H3Y-4

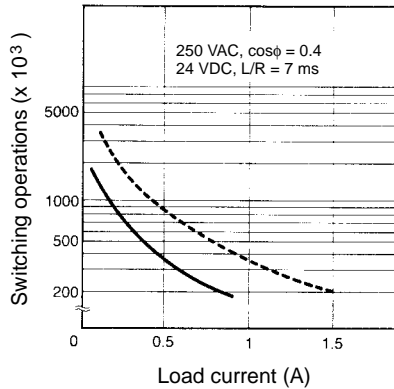

Reference: A maximum current of 0.5 A can be switched at 125 VDC ($\cos\phi = 1$). Maximum current of 0.2 A can be switched if L/R is 7 ms. In both cases, a life of 100,000 operations can be expected. The minimum applicable load is 1 mA at 1 VDC (P reference value).

Operation

■ Timing Chart

H3Y-2

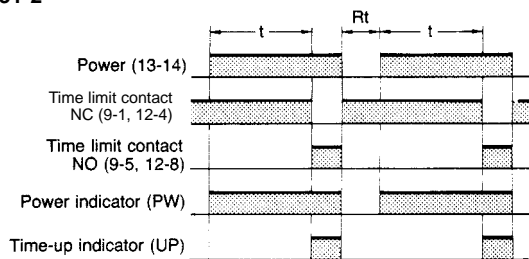

H3Y-4

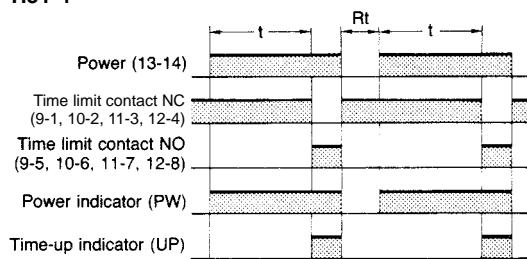

Dimensions

Note: All units are in millimeters unless otherwise indicated.

Timers

H3Y-2

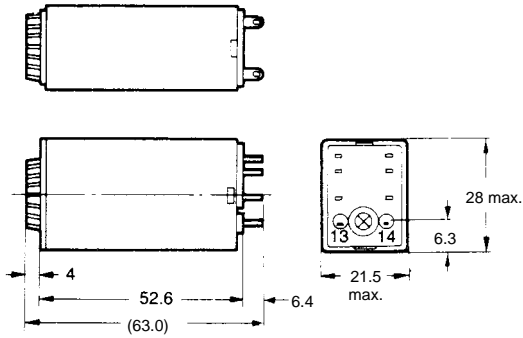

H3Y-4

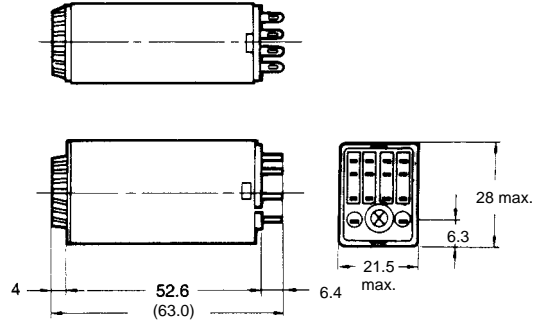

Accessories (Order Separately)

Use the PYF□A, PY□, PY□-02, or PY□QN(2) to mount the H3Y. When ordering any one of these sockets, replace "□" with "08" or "14."

Track Mounting/Front Connecting Sockets

PYF08A

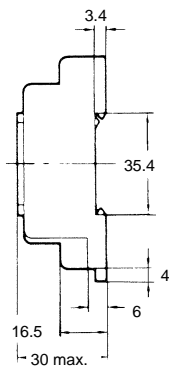
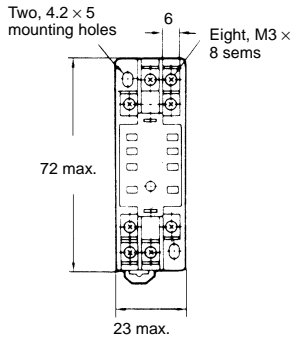

Terminal Arrangement (Top View)

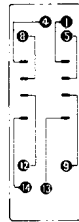

Mounting Holes

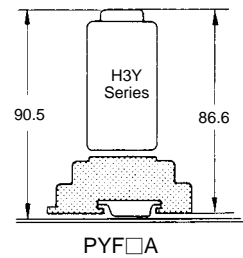
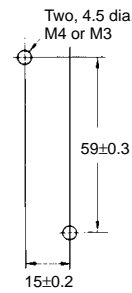

PYF14A

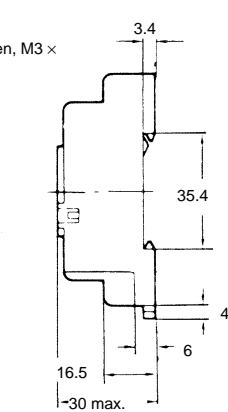
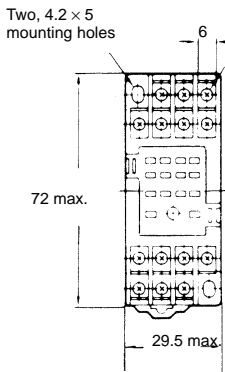

Terminal Arrangement (Top View)

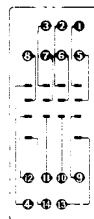

Mounting Holes

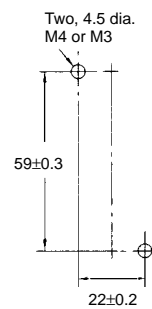

PYF08A-N

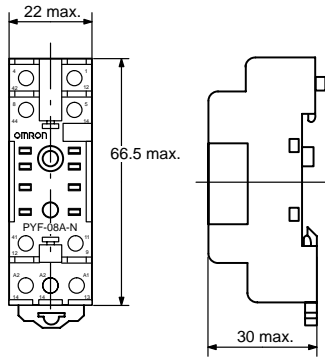

Terminal Arrangement

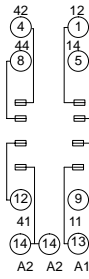

**Mounting Holes
(for Surface Mounting)**

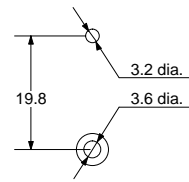

PYF14A-N

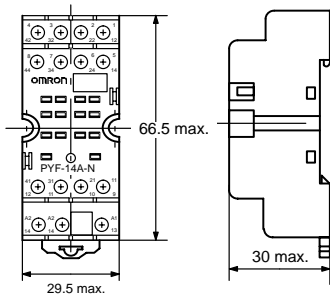

Terminal Arrangement

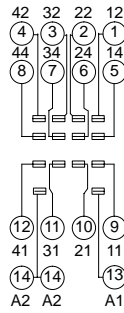

**Mounting Holes
(for Surface Mounting)**

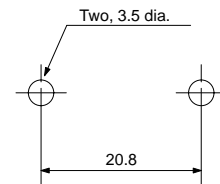

PYF08A-E

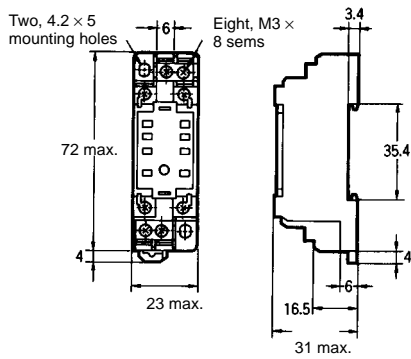

(Top View)

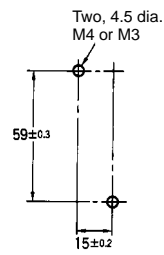
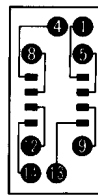

PYF14A-E

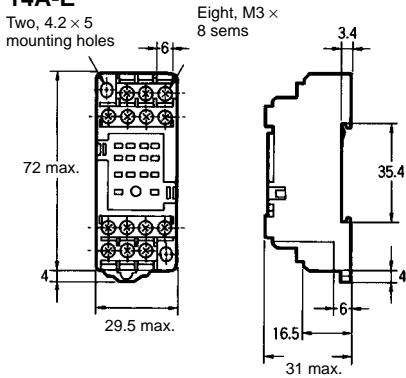

(Top View)

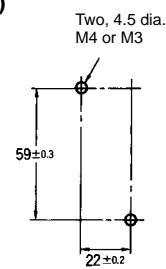
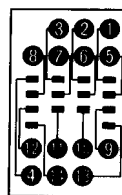

Back Connecting Sockets

PY08, PY14

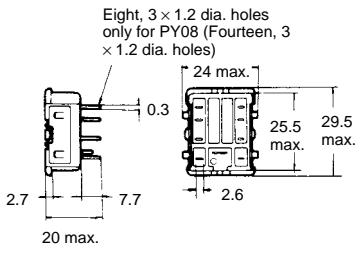

Terminal Arrangement (Bottom View)

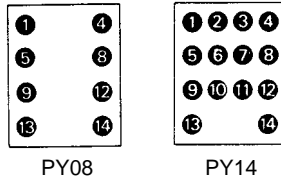

Panel Cutout

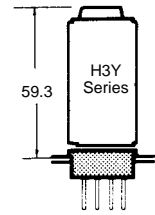
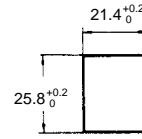

PY□, PY□-02, PY□QN(2)

**PY08QN, PY14QN
PY08QN(2), PY14QN(2)**

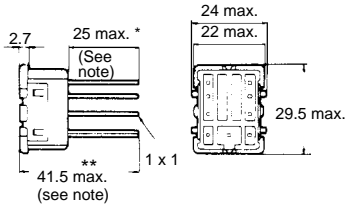

Terminal Arrangement (Bottom View)

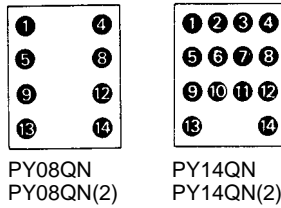

Note: With PY□QN(2), dimension * should read 20 max. and dimension ** 36.5 max.

PY08-02, PY14-02

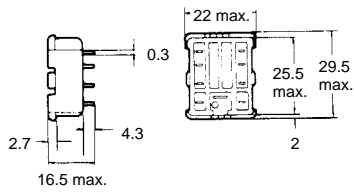

Terminal Arrangement (Bottom View)

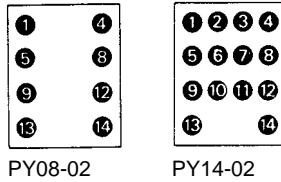

Socket Mounting Plates (t = 1.6)

| Applicable socket | For mounting 1 socket | For mounting 18 sockets |
|----------------------------------|-----------------------|-------------------------|
| PY08, PY14, PY08QN(2), PY14QN(2) | PYP-1 | PYP-18 |

Note: PYP-18 may be cut to any desired length.

PYP-1

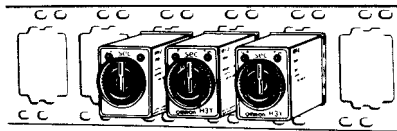
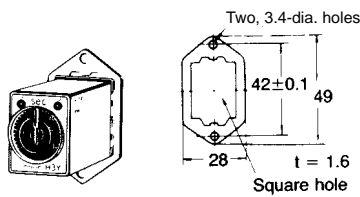

PYP-18

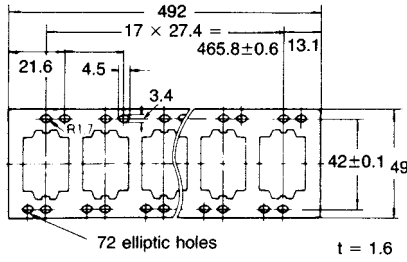

Relay Hold-down Clips

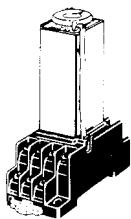

Y92H-3 for PYF□A Socket



Y92H-4 for PY□ Socket

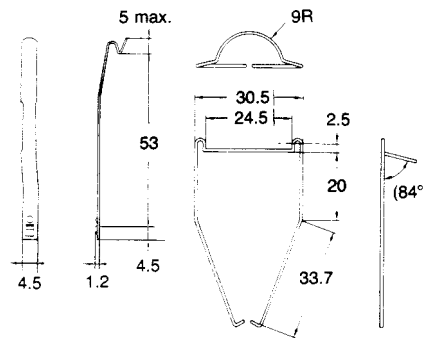

Mounting Track

PFP-100N/PFP-50N (see note 1)

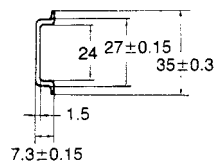
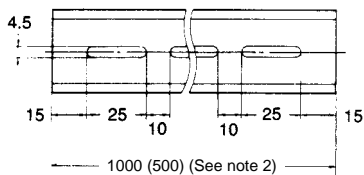

Note: 1. Meets DIN EN50022
2. This dimension applies to PFP-50N.

End Plate

PFP-M

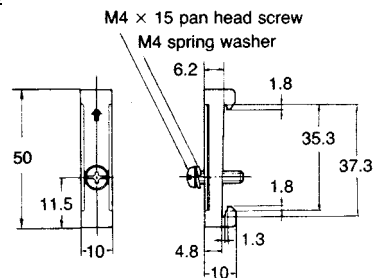

Spacer

PFP-S

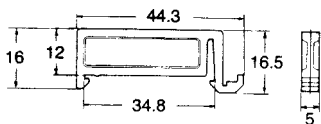

Installation

■ Connection

H3Y-2

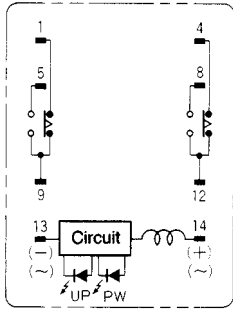

Connect the DC power supply to terminals 13 and 14 according to the polarity marks.

H3Y-4

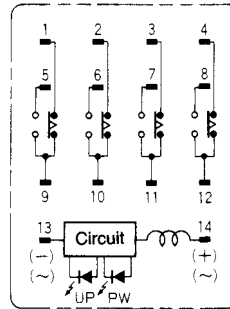

Connect the DC power supply to terminals 13 and 14 according to the polarity marks.

Precautions

When selecting a control output, use the H3Y-2 for switching ON and OFF the power and the H3Y-4 for switching ON and OFF the minute load.

The operating voltage will increase when using the H3Y in any place where the ambient temperature is more than 50°C. Supply 90% to 110% of the rated voltages (at 12 VDC: 95% to 110%) when operating at 50°C or higher.

Do not leave the H3Y in time-up condition for a long period of time (for example, more than one month in any place where the ambient temperature is high), otherwise the internal parts (aluminum electrolytic capacitor) may become damaged. Therefore, the use of the H3Y with a relay as shown in the following circuit diagram is recommended to extend the service life of the H3Y.

Use the following safety circuit when building a self-holding or self-resetting circuit with the H3Y and an auxiliary relay, such as an MY Relay, in combination.

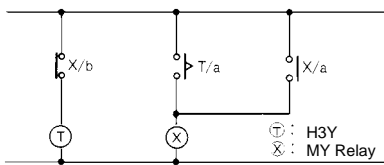
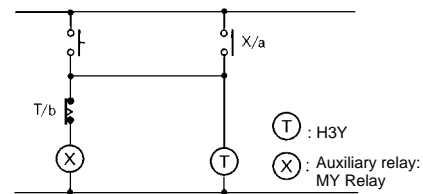

Do not use the H3Y in places where there is excessive dust, corrosive gas, or direct sunlight.

Do not mount more than one H3Y closely together, otherwise the internal parts may become damaged. Make sure that there is a space of 5 mm or more between any H3Y Models next to each other to allow heat radiation.

The internal parts may become damaged if a supply voltage other than the rated ones is imposed on the H3Y. When more than 100 V is applied to 12 or 24 VDC, the internal element (varistor) may break.

Do not connect the H3Y as shown in the following circuit diagram on the right hand side, otherwise the H3Y's internal contacts different from each other in polarity may become short-circuited.

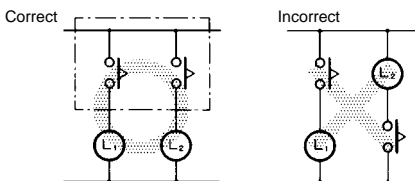

Limited issue for Southeast Asian countries

ALL DIMENSIONS SHOWN ARE IN MILLIMETERS.

To convert millimeters into inches, multiply by 0.03937. To convert grams into ounces, multiply by 0.03527.

Cat. No. L097-E1-1 In the interest of product improvement, specifications are subject to change without notice.

OMRON Corporation

Supervisory Control Devices Division
 28th Fl., Crystal Tower Bldg.,
 1-2-27, Shiromi, Chuo-ku,
 Osaka 540-6028 Japan
 Phone: (81)6-949-6035 Fax: (81)6-949-6069

Printed in Japan
 0597-2M (0597) A