

# SS12F~SS120F

Rev. D Nov.-2017

## 描述 / Descriptions

表面贴装肖特基整流二极管，反向电压：20~200V，正向电流：1.0A，薄型 SMAF 封装。

Surface Mount Schottky Barrier Rectifier, Reverse Voltage: 20 to 200 V, Forward Current:1.0A ,SMAF thin package.

## 特征 / Features

低功耗，高效率，正向浪涌电流大，适用于低压高频逆变器和极性保护，适用于表面贴装。无卤产品。

Low power loss, high efficiency, High forward surge current capability, For use in low voltage, high frequency inverters, and polarity protection applications, For surface mounted applications. Halogen free product.

## 用途 / Applications

一般用途。

General purpose.

## 内部等效电路 / Equivalent Circuit



## 引脚排列 / Pinning

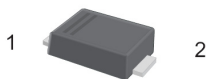

PIN	DESCRIPTION
1	Cathode
2	Anode

The recommended mounting pad size

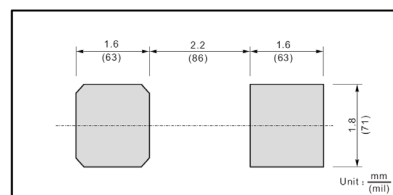

## 印章代码 / Marking

见印章说明。 See Marking Instructions.

**极限参数 / Absolute Maximum Ratings(Ta=25°C)**

参数 Parameter	符号 Symbol	数值 Rating								单位 Unit
		SS12F	SS14F	SS16F	SS18F	SS110F	SS112F	SS115F	SS120F	
Maximum Repetitive Peak Reverse Voltage	$V_{RRM}$	20	40	60	80	100	120	150	200	V
Maximum RMS voltage	$V_{RMS}$	14	28	42	56	70	84	105	140	V
Maximum DC Blocking Voltage	$V_{DC}$	20	40	60	80	100	120	150	200	V
Maximum Average Forward Rectified Current	$I_{F(AV)}$	1.0								A
Peak Forward Surge Current, 8.3ms Single Half Sine-wave Superimposed on Rated Load (JEDEC method)	$I_{FSM}$	40				30				A
Typical Junction Capacitance <sup>1)</sup>	$C_i$	110			80					pF
Typical Thermal Resistance <sup>2)</sup>	$R_{\theta JA}$	95								°C/W
Operating Junction Temperature Range	$T_j$	-55~+125								°C
Storage Temperature Range	$T_{stg}$	-55~+150								°C

Note:

- 1) Measured at 1MHz and applied reverse voltage of 4 V D.C.
- 2) P.C.B. mounted with 0.2 X 0.2" (5 X 5 mm) copper pad areas.

**电性能参数 / Electrical Characteristics(Ta=25°C)**

参数 Parameter	符号 Symbol	测试条件 Test Conditions	数值 Rating								单位 Unit
			SS12F	SS14F	SS16F	SS18F	SS110F	SS112F	SS115F	SS120F	
Max Instantaneous Forward Voltage	$V_F$	$I_F=1.0A$	0.55		0.70		0.85		0.90		V
Maximum DC Reverse Current at Rated DC Reverse Voltage	$I_R$	$T_a=25^\circ C$	0.3				0.2		0.1		mA
		$T_a=100^\circ C$	10				5.0		2.0		

电参数曲线图 / Electrical Characteristic Curve

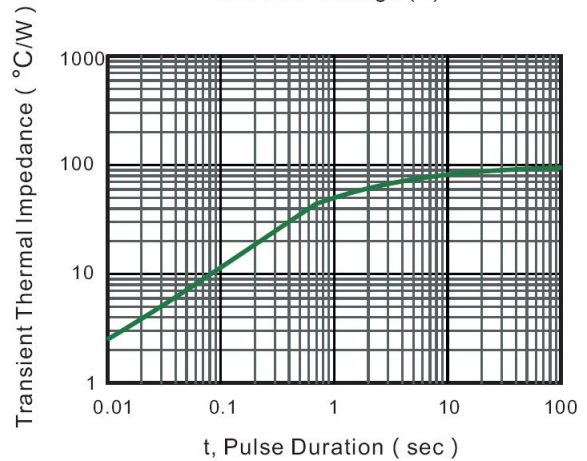
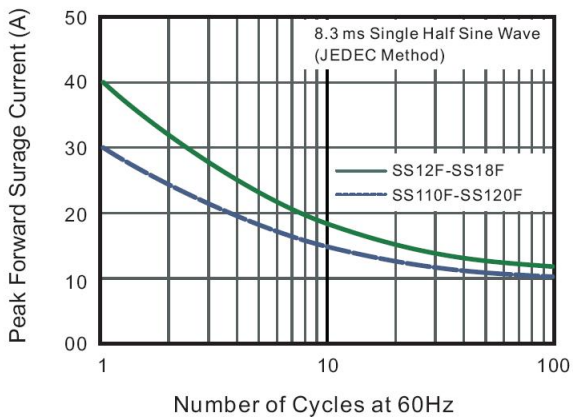
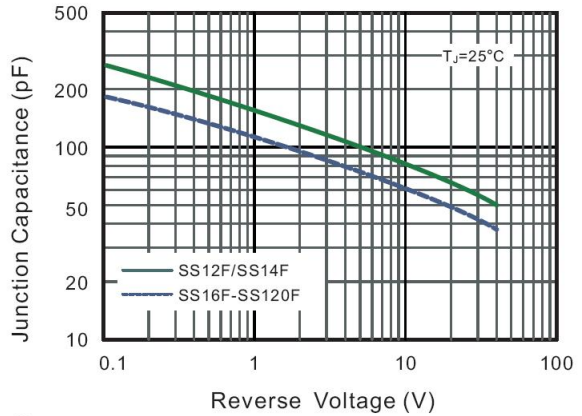
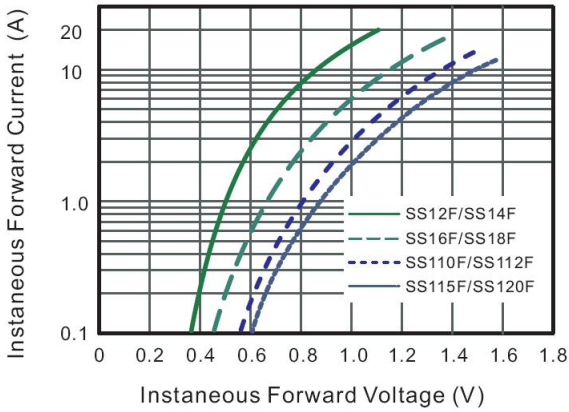
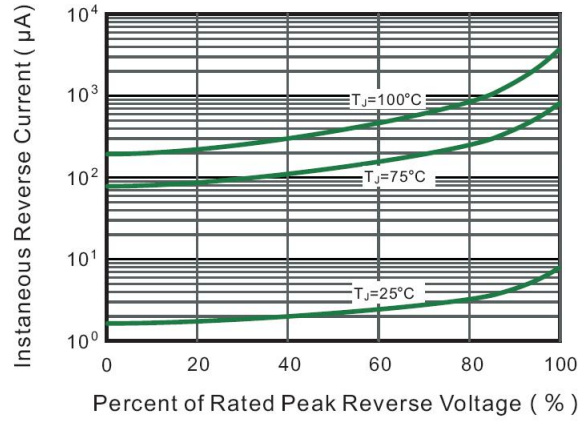
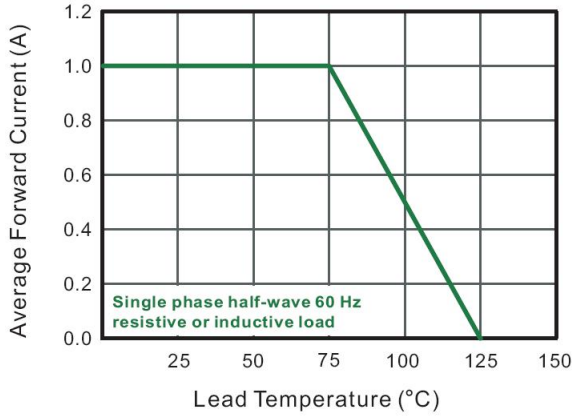

外形尺寸图 / Package Dimensions

SMAF

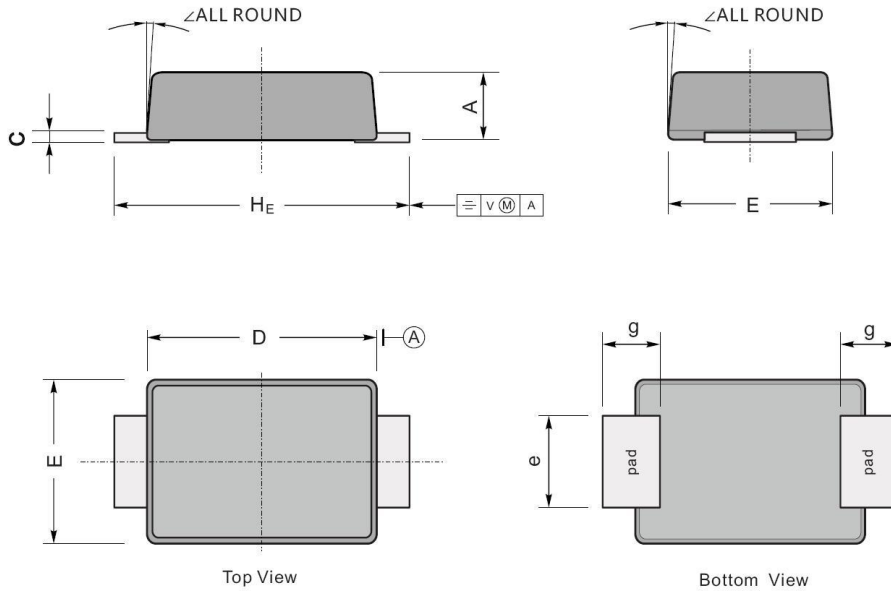

UNIT		A	C	D	E	e	g	$H_E$	$\angle$
mm	max	1.2	0.20	3.7	2.7	1.6	1.2	4.9	7°
	min	0.9	0.12	3.3	2.4	1.3	0.8	4.4	
mil	max	47	7.9	146	106	63	47	193	
	min	35	4.7	130	94	51	31	173	

## Marking

Type number	Marking code
SS12F	SS12
SS14F	SS14
SS16F	SS16
SS18F	SS18
SS110F	SS110
SS112F	SS112
SS115F	SS115
SS120F	SS120

印章说明 / Marking Instructions



说明

SS12 : 为型号代码

\*\*\*\* : 为生产批号追溯码，第 1 个\*为年月代码，后面 3 个\*为当月小批号代码

Note:

SS12 : Product Type Code

\*\*\*\* : Lot No. Code ,The 1st \* means:YM Code ,The last 3 \* means:little Lot  
No Code

**回流焊温度曲线图(无铅) / Temperature Profile for IR Reflow Soldering(Pb-Free)**

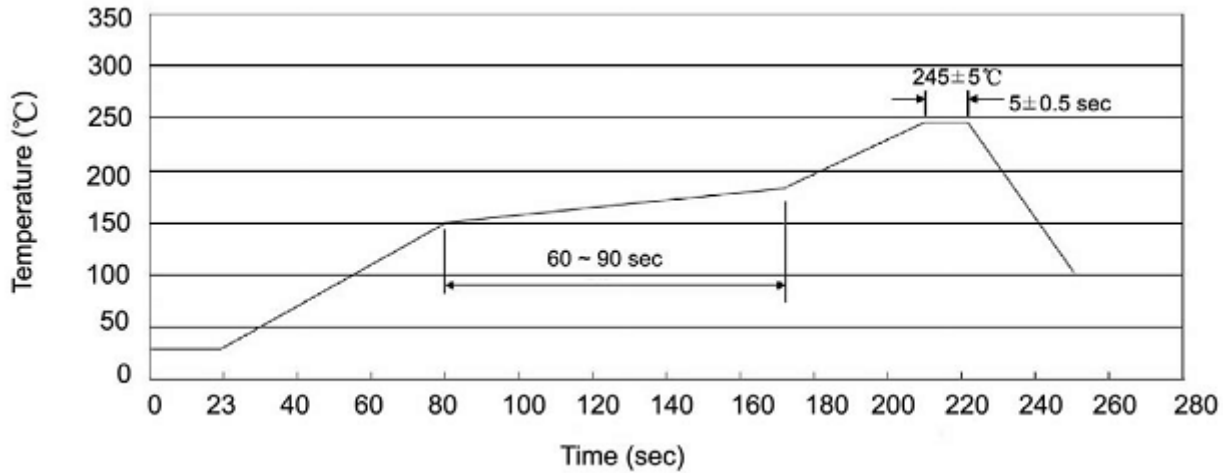

说明：

- 1、预热温度 25 ~ 150°C，时间 60 ~ 90sec;
- 2、峰值温度 245±5°C，时间持续为 5±0.5sec;
- 3、焊接制程冷却速度为 2 ~ 10°C/sec.

Note:

- 1.Preheating:25~150°C, Time:60~90sec.
- 2.Peak Temp.:245±5°C, Duration:5±0.5sec.
3. Cooling Speed: 2~10°C/sec.

**耐焊接热试验条件 / Resistance to Soldering Heat Test Conditions**

温度：260±5°C

时间：10±1 sec.

Temp.:260±5°C

Time:10±1 sec

**包装规格 / Packaging SPEC.**

卷盘包装 / REEL

Package Type 封装形式	Units 包装数量					Dimension 包装尺寸 (unit: mm <sup>3</sup> )		
	Units/Reel 只/卷盘	Reels/Inner Box 卷盘/盒	Units/Inner Box 只/盒	Inner Boxes/Outer Box 盒/箱	Units/Outer Box 只/箱	Reel	Inner Box 盒	Outer Box 箱
SMAF	3000	5	15000	5	75000	7" ×11	185X180X105	390X385X205

**使用说明 / Notices**