

Pulsar Edge Controller Family

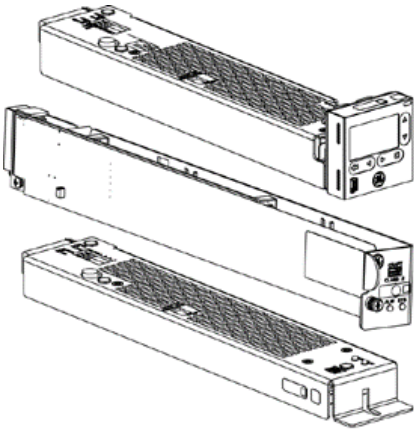

Typical Controllers

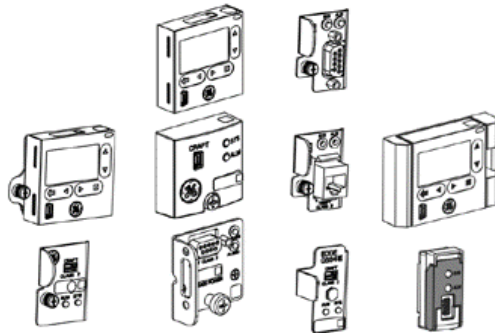

Typical Controllers Faces

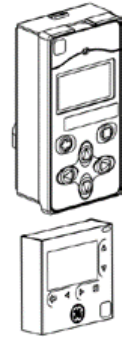

Typical Separate Displays

This page intentionally left blank

Pulsar Edge Controller Family

Table of Contents

Table of Contents	3
Table of Figures	7
Table of Tables	8
Introduction	9
Overview	9
Key Features	9
Applications	11
Product Description	15
Overview	15
Configurations	15
Getting Started – Installation, Start-Up, and Basic Configuration	19
Preparation.....	19
Safety.....	19
Installation Tools.....	19
Packaging.....	19
Install the Pulsar Edge Controller.....	19
Connect to the Controller.....	23
Initial Startup of the Controller.....	24
Craft Port.....	25
Web Interface	29
LAN Port as the Craft Port.....	29
Basic Controller Configuration	32
Operation	35
Overview	35
Front Panel Display Option.....	35
System Status Display	36
Menu Navigation Buttons.....	38
Front Panel PIN.....	38
Front Panel Menus	40
Local and Remote Access Ports	45
Web Pages	45
Web Interface Structure	48
Home Tab	52
Reports Tab	56
Maintenance Tab.....	61
Settings Tab - Configuration	62

Installation Tab.....	90
Software Tab	91
Controller Peripherals	93
One-Wire Peripheral Devices.....	93
QS873A Voltage/Thermal Probes	93
ES771A Remote Mid-String Voltage Monitor Module.....	95
NE872A Remote Distribution Monitor and Control Module.....	99
QS871A Remote Distribution Monitor and Control Module.....	103
Troubleshooting.....	109
Checking for Defective VT-Probes.....	112
Specifications.....	113
Safety	117
Safety Statements.....	117
Precautions	117
Appendix A: Software Backup / Restore Through Network Connection.....	119
Application Software.....	121
Web Pages	122
Backup/Restore Configuration File.....	123
Backing Up/Retrieving	123
Restoring.....	123
Appendix B: T1.317 Command Language.....	125
Serial Access to the Pulsar Edge Controller	125
Introduction	126
Objects, Attributes, and Related Commands.....	127
Additional T1.317 Commands and Samples.....	145
Error Messages.....	153
Appendix C: Battery Functions.....	155
Float Mode.....	155
Slope Thermal Compensation	155
Temperature Alarms	156
High Temperature Compensation	157
Low Temperature Compensation.....	157
Plant Battery Test.....	158
Boost Mode	159
Auto-Boost Charge.....	159

Redundancy Loss Function	159
Battery Voltage Imbalance Detection	160
Battery Recharge Current Limit.....	161
Battery Parameter Defaults.....	161
Appendix D: Default Configurations.....	163
Appendix E: Alarms and Relays	185
Alarm Relays	185
Alarms	185
Appendix F: SNMP	189
SNMP Overview	189
SNMP Operations.....	190
SNMP Configuration	190
Community Strings	191
Appendix G: Secure Protocols	193
Overview	193
Configuration	193
Reboot Required	193
Security.....	193
Internet Protocols (IPv4 And IPv6)	194
HTTPS (SSL)	195
SNMP.....	197
SFTP.....	198
SSH.....	200
Revision	201

This page intentionally left blank

Table of Figures

Figure 1 Compact Power (CP) Line Shelves- CP841A Family of Controllers.....	11
Figure 2 Small Power System (SPS) Line Shelves- SPS841A Family of Controllers	12
Figure 3 CPS6000 Series II Power System (QS) Line Shelves- QS841E Family of Controllers	12
Figure 4 Infinity NE Converter Power Shelves- QS841E and NE841A Family of Controllers	12
Figure 5 Edge Rectifier Shelf – GCP841E Family of Controllers	13
Figure 6 General Power System Block Diagram	15
Figure 7 Block Diagram of Pulsar Edge CP841A Controller with the J2007001	16
Figure 8 Pulsar Edge Front Panel Display Assembly.....	36
Figure 9 Pulsar Edge Status Menu	41
Figure 10 Pulsar Edge Control / Operations and History Menus	42
Figure 11 Pulsar Edge Configuration Menu (part 1)	43
Figure 12 Pulsar Edge Configuration Menu (part 2).....	44
Figure 13 Reports Menu.....	49
Figure 14 Maintenance Menu.....	50
Figure 15 Settings Menu	51
Figure 16 Installation and Software Menu	52
Figure 17 QS873A Voltage/Thermal Probe (VT-Probe)	93
Figure 18 VT-Probe Connections to Infinity NE.....	94
Figure 19 ES771A Remote Voltage Monitor Module.....	96
Figure 20 Four-String System Monitored For Imbalance	97
Figure 21 Same System Monitored For Imbalance with VT Probe on Every Battery	98
Figure 22 NE872A Remote Distribution Module	99
Figure 23 NE872A ID Jumper Settings.....	101
Figure 24 NE872A ID Jumper Settings.....	102
Figure 25 QS871A Remote Distribution Module.....	103
Figure 26 Slope Thermal Compensation.....	156
Figure 27: Security Configuration	193
Figure 28: Network Settings for IPv4 and IPv6	194
Figure 29: Security Problem Screen Using Explorer	195
Figure 30: Mismatched Address Certificate Error Screen	196
Figure 31: HTTPS Connectivity Over IPv6 Controller Login Screen	196
Figure 32: SNMP Settings Screen	197
Figure 33: Sample WinSCP Configuration Screen For Disable	198
Figure 34: WinSCP Login Screen	198
Figure 35: WinSCP Security Key Warning Screen	199
Figure 36: PuTTY Security Key Warning Screen	200
Figure 37: PuTTY SSH Login Example Screen	200

Table of Tables

Table 1 Pulsar Edge Family Naming Convention	17
Table 2 Pulsar Edge Product Examples	18
Table 3 Current Calculations	69
Table 4 Power System Troubleshooting	109
Table 5 Supported Battery Types	161
Table 6: Standard Configuration Items	163
Table 7 48V Battery Related Items	180
Table 8 24V Battery Related Items	182
Table 9 Converter Related Items	183
Table 10 Alarms, Alarm Relays and LEDs Assignments	185

Introduction

Overview

The Pulsar Edge family of controllers is part of the Pulsar family of power system controllers that includes Pulsar Plus and Pulsar Edge controllers.

Pulsar Edge controllers were developed to be integrated into the power shelves of the Compact Power Line (CPL), Slimline Power Systems (SPS), CPS6000 Series II power systems, Infinity NE group of shelves, and GCP group of shelves.

These controllers were developed for both indoor and outdoor cabinet power applications.

The modular hardware and software design of the Pulsar Edge allows for easy customization for specific applications.

Controllers provide control and alarm monitoring functions over several communication interfaces including a standard RS-485 digital serial interface that interconnects system rectifiers, converters, and other peripherals. Compatible rectifiers include NE, CP, NP, EP, and IP series.

Local and remote access is provided.

Features are factory configured to industry standard defaults to minimize the setup process in the field. Customer specified factory default configuration is also available.

Key Features

- Modular design utilizing a dedicated power shelf location leaving maximum power modules
- Easy field insert or removal (hot insert)
- Standard or customer specific factory defaults supported
- Control and management of Rectifiers and Converters: Infinity NE, CPS6000, Compact Power Line, Slimline Power System, etc.
- Extensive Battery Management features
 - Management of four independent Low Voltage Disconnects (LVDs)
 - Up to eight contactors assignable to the LVDs
 - Load disconnects operated by low voltage, low voltage and/or time delay, remote command, or external control signal
 - Battery disconnect operated by voltage threshold, voltage threshold and/or time, Adaptive Threshold, remote command, high battery temperature, or Emergency Power Off (EPO) signal
 - Integrated contactor control for single contactor, additional contactor control through remote distribution and control modules
 - Battery recharge current limit feature
 - Low and high temperature voltage compensation
 - Individual adjustable slopes
 - High temperature step function
 - Probe Fail-Safe feature
 - Manual and automatic Boost
 - Local (manual) discharge test, remote discharge test, and periodic discharge test capability.
 - Reserve time calculations with configurable threshold
 - Manual time threshold for pass/fail criteria

- 1-Wire monitoring
 - Up to six ES771 Mid-string voltage monitors (Configurable mid-string imbalance voltage threshold alarm)
 - Up to sixteen QS873 battery thermal probes (Configurable High, Very High, Low, and Very Low battery temperature alarms)
- Alarm management of DC distribution
- Six configurable system alarm inputs
- Additional Factory configurable Input/Output options:
 - Up to 9 configurable binary alarm inputs or
 - Up to six alarm outputs or
 - Combination of alarm inputs and alarm outputs

*Number of inputs/outputs depends on Pulsar Edge configuration
- Alarm output test feature
- Integrated 10/100Base-T Ethernet for local port or for Network remote monitoring
 - Supports SNMP, TCP/IP, SMTP, HTTP, Telnet, FTP, and utilizes Dynamic Host Configuration Protocol (DHCP)
 - SNMP Trap Test feature
 - Community string support
 - Remote software and configuration upgrade capability
 - Internal web server compatible with standard browsers (MS Internet Explorer)
- Various Reports
 - Inventory Report
 - Event history log
 - Statistics and Trend data
 - Battery Discharge
- Energy Efficiency Algorithm
- Rectifier Group Standby/ Hold-off mapping (generator/AC load minimization)

Applications

The Pulsar Edge controller is available in applications involving the Compact Power Line (CPL), Slimline Power Systems (SPS), CPS6000 Series II power systems, Infinity NE group power shelves, and GCP group of shelves. These systems consist of an integrated controller power shelf that can be single shelf systems with integrated distribution or multi-shelf systems with external distribution for battery or battery-less DC power systems. The controller is available with or without a front panel display and user interface in the CPS6000 Series II, Infinity, and SPS product lines. CPL supports display-less options of the Pulsar Edge. Following are a few product depictions utilizing the various Pulsar Edge controller configurations. Consult appropriate system manuals, technical field support or your local sales representative for more details on these or other power systems that may utilize the Edge controller.



Figure 1 Compact Power (CP) Line Shelves- CP841A Family of Controllers



Figure 2 Small Power System (SPS) Line Shelves- SPS841A Family of Controllers



Figure 2 Small Power System (SPS) Line Shelves- SPS841A Family of Controllers (continued)



Figure 3 CPS6000 Series II Power System (QS) Line Shelves- QS841E Family of Controllers



Figure 4 Infinity NE Converter Power Shelves- QS841E and NE841A Family of

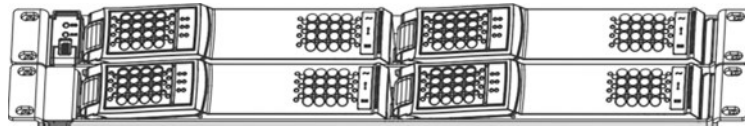

Figure 5 Edge Rectifier Shelf – GCP841E Family of Controllers

Applications (Continued)

Systems that utilize the Pulsar Edge controller provide a dedicated location for the controller that allows the maximum number of power modules to be used per shelf. Present systems locate the controller to a dedicated position located to the left of the left most power position in the shelf. The Pulsar Edge controller is typically pre-installed into the power shelf at the factory. However, it can be ordered separately for spares, installed in the field, or integrated into custom systems. Access to the controller inputs/outputs is typically located on one or two connectors located at the rear of the shelf. There are front access shelf designs that locate these connectors to the front of the shelf. For details on these connections consult each of the product's individual installation guides.

The Pulsar Edge controller provides controller configurations that have a front panel RS232 asynchronous Craft port or USB connection for local terminal access. The standard RS232 asynchronous Craft port connection is a DB9 but an RJ45 serial port connection is available in specific configurations. Easy View 2, which simulates the web page interface, is provided as the Graphical User Interface when accessing the Craft port over the RS232 or USB connection. This program is downloadable from the OmniOn home page. A front panel LCD user interface with capacitive touch soft -keys is also available on several of the platforms for interacting with the controller and power system.

All Pulsar Edge controllers utilize the same base processor board and application code. This board is populated and packaged differently for the different power system applications. However, software updates performed in the factory are implemented in all configurations at a time. Since the processor board and software is common to all Pulsar Edge configurations the controllers have the same basic operation and functionality. These operations and features are described in this product manual.

This page intentionally left blank

Product Description

Overview

OmniOn rectifiers accept alternating current (ac) power and rectify it to produce direct current (dc) power for powering external equipment (loads). Converters accept the dc output from rectifiers or other sources and convert it to various regulated output dc levels also needed for powering external equipment (loads). Batteries, generators, and UPS are typically used to provide backup power when ac is lost. Batteries are connected in parallel for additional capacity with the rectifier outputs through appropriate breakers and contactor disconnects. DC power is distributed through distribution panels with various protectors and contactors. These rectifiers, backup systems, and distribution components are all managed by the Pulsar Edge system controller. The following figure depicts a generic representation of the system controller and its relationship in a power system. The components depicted and their associated features as they relate to the system controller will be discussed in this manual.

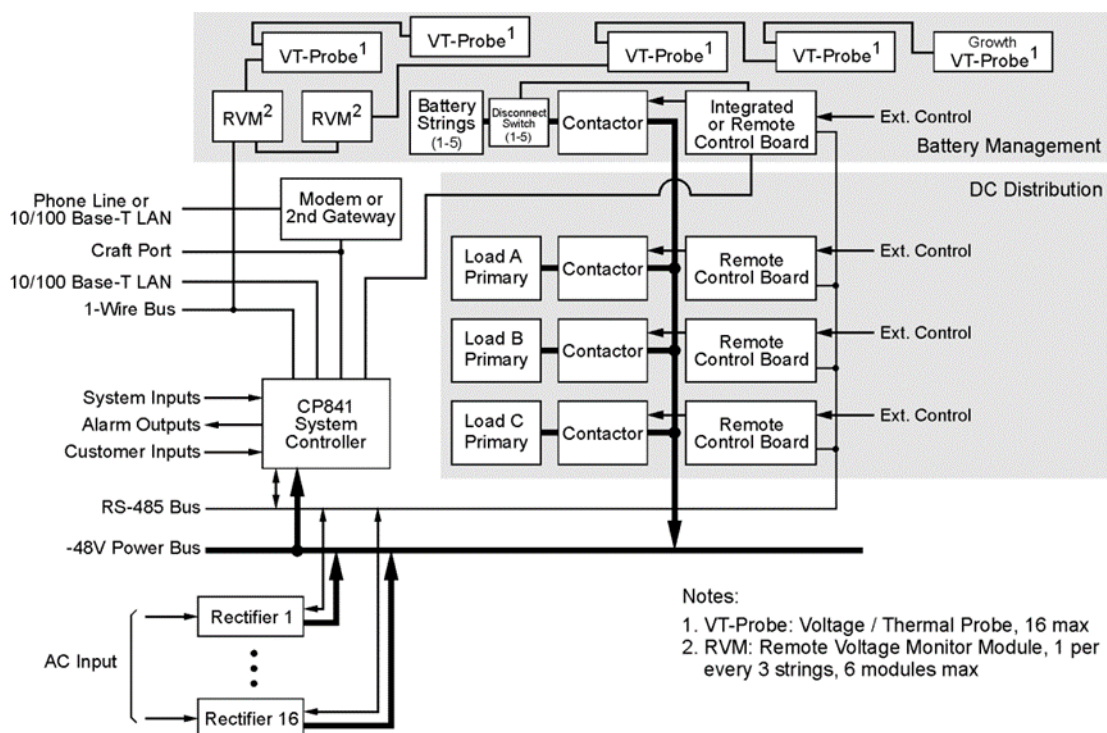

Figure 6 General Power System Block Diagram

Configurations

The main “841” microprocessor board comprises the Pulsar Edge family of power system controllers. This controller is designed to fit a variety of systems and applications. Systems utilizing this controller are designed to allow the controller be quickly installed or removed from its allocated position through a simple thumb-screw or insertion fit without having to remove input output cable attachments to the unit. The input and output cable assemblies are connectorized and can quickly be removed or installed into the respective power shelves the controller resides. There are different configuration options for the Pulsar Edge controller which be configured differently for these power systems.

Configuration includes the number of customer inputs or outputs, the desired front panel Craft port interface, display option, as well as custom factory configuration. These options must be ordered and are pre-installed at the factory.

The following figure shows a generic block diagram of the basic components of the Pulsar Edge controller for a CPL power shelf. The exact system interconnect will vary depending on the shelf design but this provides the basic concept of controller interconnect common to all.

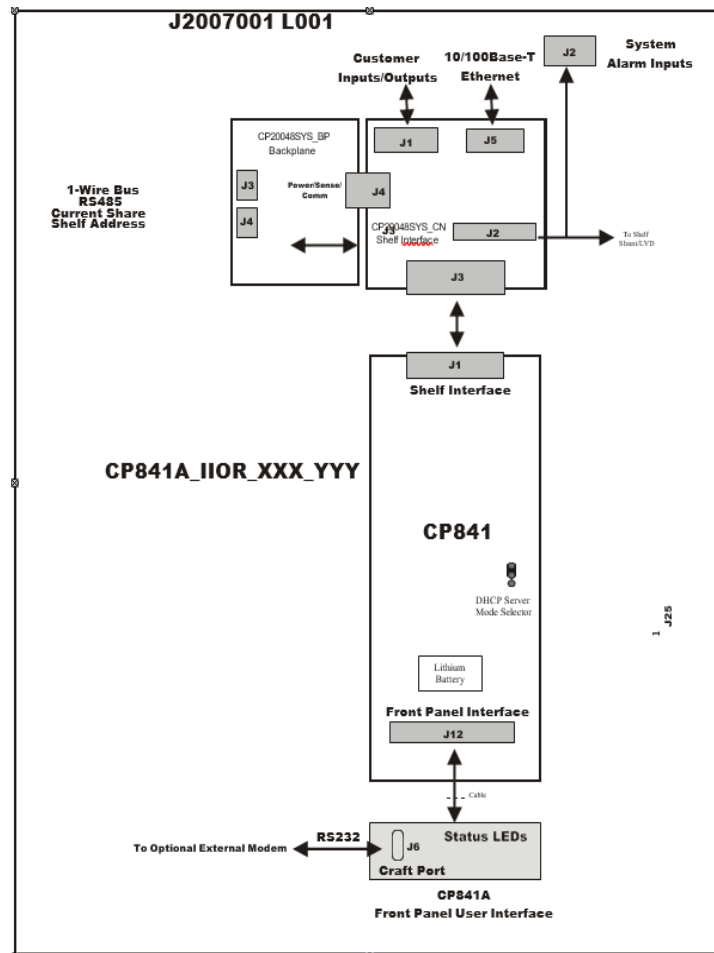

Figure 7 Block Diagram of Pulsar Edge CP841A Controller with the J2007001

Examples of Pulsar Edge controller options are defined in this section. Consult the controller ordering guide (Pulsar_Edge-AD) and sales for the most complete and up-to-date listing. The table below provides the basic naming nomenclature utilized for the different Pulsar Edge controller configurations.

Where :

ZZZ	Identifies the product family of Pulsar Edge controller. (Valid IDs are CP, GCP, SPS, QS, and NE)
A	This identifies the controller form factor option (A or E = Shelf Mount, D = Panel Mount)
nW mR	Identifies the input/output hardware configuration ¹ for the controller. “nW” identifies the inputs and how they are configured. The first digit, “n”, represents the number of inputs (0 through 9). The second digit, “W”, represents the type of return provided for these inputs (I=Individual Returns, C = Common Return). “mR” identifies the alarm outputs. The first digit, “m”, represents the number of outputs present (0 through 5). The second digit is R (for Relay).
xxx	Identifies the front panel Craft port interface option installed (Blank = standard DB9 female interface, RJ= Standard TIA RJ45, RJC = Cisco RJ45, D = Mini USB with Display, DS = Mini USB with Display)
S	Identifies Secured Protocols ² option installed. (Blank = Standard , S = Secure Protocols)
YYY	Identifies a customer or application specific software configuration version of the controller (Blank = Standard). These codes are specifically assigned to an application where defaults are clearly predefined to minimize field configuration and error. Consult appropriate sales personnel for additional information.

Table 1 Pulsar Edge Family Naming Convention ZZZ 841 A_nW mR_XXX_S_YYY

¹There is a dependency on the number of outputs and inputs.

²Secure Protocols include SNMPv3, IPv6, and HTTPS/SSH/SFTP

The following table identifies controller examples. Other combinations may be available. Please consult sales and technical field support for additional information.

Configuration	Comcode ³	Description
CP841A_0I5R	CC109145356	Controller for CP applications with DB9 front panel interface, no supplementary “configurable” inputs, five output alarm relay contacts, and standard code.
CP841A_3C3R	CC109145331	Controller for CP applications with DB9 front panel interface, three supplementary inputs with common return, three output alarm relay contacts, and standard code.
CP841A_3C3R_RJC	CC109145348	Controller for CP applications with a RJ45 RS232 with Cisco pin-outs front panel interface, three supplemental inputs with common return, three output alarm relay contacts, and standard code.
CP841A_9C0R	CC109140068	Controller for CP applications with DB9 front panel interface, nine supplemental inputs with common return, no output alarm relay contacts, and standard code.
CP841A_9C0R_NT1	CC109141017	Application specific version of CP841A_9C0R.
SPS841A_3C3R	CC109142238	Controller for SP shelf applications with a DB9 front panel interface, three inputs with common return, three output alarm relay contacts, and standard code.
SPS841A_0I5R	CC109152377	Controller for SP shelf applications with a DB9 front panel interface, no supplemental inputs, five output alarm relay contacts, and standard code.
SPS841A_0I5R_D	CC109156898	Controller for SP shelf applications with a DB9 front panel interface, no supplemental inputs, five output alarm relay contacts, standard code, and front panel LCD.
SPS841A_0I5R_D_VZB1	CC109156898	Application specific version of SPS841A_0I5R_D.
QS841E_0I6R_USB	CC109156535	Controller for CPS6000 Series II applications with USB front panel interface, no supplemental inputs, six output alarm relay contacts, and standard code.
QS841E_0I6R_USB_CS1	CC109156758	Application specific version of QSS841E_0I6R_USB.
QS841E_0I6R_USB_VZT1	CC109158283	Application specific version of QSS841E_0I6R_USB.
QS841E_0I6R_USB_QW1	CC109159447	Application specific version of QSS841E_0I6R_USB.
QS841E_0I6R_USB_VZB1	CC109159430	Application specific version of QSS841E_0I6R_USB.
NE841E_0I6R_USB	CC109167053	Controller for Infinity NE-C applications with USB front panel interface, no supplemental inputs, six output alarm relay contacts, and standard code.
NE841E_0I6R_USB S	150041556	NE841E_0I6R_USB with Secure Protocols
GCP841A_0I6R_USB	150043558	Controller for Edge (GCP) applications

Table 2 Pulsar Edge Product Examples

³ Units without assigned comcodes may still be under development or in the planning state. Other combinations may be available. Consult sales and technical field support for additional information.

Getting Started—Installation, Start-Up, and Basic Configuration

Preparation

This section outlines the sequence for installing and quickly configuring the Pulsar Edge controller into a typical power system. A sample system will be illustrated here as an example but the individual installation start-up guides must be consulted for specific shelves. Some power system shelf configurations will be shipped from the factory with the controller pre-installed.

Safety

Read and follow all safety statements, warnings, and precautions in the Safety section of this manual and manuals of all other equipment before installing, maintaining or repairing the equipment.

Installation Tools

You will need the following tools to install and test the Power System:

- Wire cutters and strippers
- Heat shrink gun
- 5/16-inch (8 mm) hex driver
- 1/4-inch hex driver
- Digital meter with an accuracy of $\pm 0.02\%$
- Screw drivers (flat-blade and Phillips)
- ESD wrist strap
- Assortment of socket wrenches and drivers
- Test cable
- Protective canvas
- Insulating rubber mat
- Windows-based personal computer laptop (PC) and cable to connect the PC communications port to the local port of the controller or a CAT5 LAN cable.

Packaging

- All packages must be opened with a box cutter with the blade minimally exposed to cut only the sealing tape.
- Save all packaging material until the system has been powered up and all parts are operating within specifications. The shipping package may be used to return defective parts.

Install the Pulsar Edge Controller

The Pulsar Edge is easily slid in and out of a dedicated position in the shelf. Some shelf configurations will have the controller factory preinstalled. This section primarily uses the Compact Power Line controller as an example but the information provided is valid for other system configurations and must be used with information in the Installation Start-Up documentation for each specific system. Before applying power, a few basic controller configurations may be required. The following describes steps for this initial configuration.

Install Pulsar Edge Controller	
Step	Action
1	<p>Connection For ESD Prevention</p> <p>Attach an ESD wrist strap or equivalent to an appropriate ESD grounding connector on your frame or system.</p>
2	<p>Grounding the System</p> <p>Note: before connecting the USB or RS-232 port to your PC, be sure that the power system and its output are properly grounded. Discharge Ground (DG) bus must be connected to earth ground. CAUTION: damage to the controller may occur if the USB or RS-232 port is connected to a PC when Discharge Ground (DG) bus is not referenced to earth ground.</p>
3	<p>Configuring Individual Alarm Output Contact Type- “Close” on or “Open” on alarm Individual alarm output contact types can be configured to Close or Open on an alarm. If your controller has no output alarm contacts continue to Step 4. The factory default configuration for all alarm outputs in standard controller configurations is to “Open” on an alarm event. If this acceptable go to Step 4 otherwise continue.</p>
	<p>Locate configuration jumpers for alarm relays on Edge-mounted controller.</p> <p>Loosen the chassis captive securing fastener and remove the controller from the shelf.</p> <div style="text-align: center;"> <p>Captive Fastening Screw</p> </div> <p>Carefully remove the control unit from the shelf and locate the small opening in the chassis that allows external access to configuration jumpers.</p> <div style="text-align: center;"> <p>Alarm Output Configuration Jumpers</p> </div> <p>Locate the jumpers for the alarm relays. The number of jumpers present equals the number of output alarms contacts available for the respective controller. The maximum number of jumpers possible is six while the minimum is zero. The figure below shows three jumpers for the CP841_3C3R controller. Similar openings and jumpers are used in controller configurations for other power systems.</p>

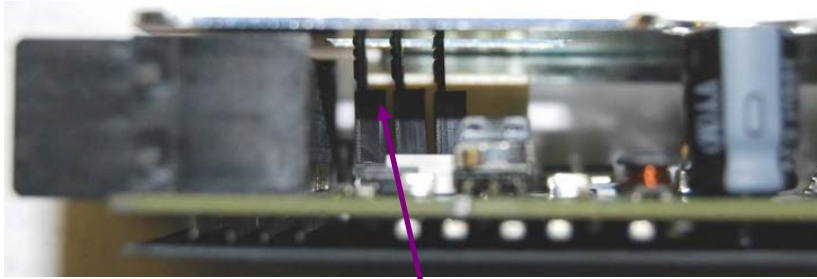
Install Pulsar Edge Controller																						
Step	Action																					
	<div data-bbox="305 426 506 485" data-label="Text"> <p>Alarm Configuration Jumpers</p> </div>   <div data-bbox="760 1010 1114 1035" data-label="Caption"> <p>Three Alarm Configuration Jumpers</p> </div>																					
4	<p>Configuring alarm relay contacts to “Open” or “Close” on alarm as required: Jumpers J20-25 configure the contact type provided at the system alarm interface for each respective Form-C alarm output present on the controller. Once the correct alarm jumper is located, carefully move each of respective configuration jumpers to the desired contact type: “Open On Alarm” or “Closed On Alarm” position as required. An insulated tool must be used to grab the top of the jumper tabs. Move the jumpers accordingly and make sure that they are pushed in and secure. Since each jumper corresponds to one alarm relay each relay output can be configured independently. The following table contains the alarms along with the factory default alarm assignments to user relays when present. The alarms are described from right to left position when looking at the controller and placing the jumpers and board connector on the right (as shown in previous picture). Utilize the web or EasyView2 interface to change any of the alarm user relay alarm assignments. Note: jumpers are present for the number of output alarm relays implemented in the controller.</p> <table border="1"> <thead> <tr> <th>Jumper Number</th> <th>Signal Name</th> <th>Pulsar Edge Standard Defaults</th> </tr> </thead> <tbody> <tr> <td>J24</td> <td>Relay 6</td> <td>Power Major Alarm (PMJ)</td> </tr> <tr> <td>J23</td> <td>Relay 5</td> <td>Power Minor Alarm (PMN)</td> </tr> <tr> <td>J19</td> <td>Relay 4</td> <td>Fuse Alarm Major (External FAJ)</td> </tr> <tr> <td>J20</td> <td>Relay 3</td> <td>AC Fail (ACF)</td> </tr> <tr> <td>J21</td> <td>Relay 2</td> <td>Rectifier Fail alarm (RFA)</td> </tr> <tr> <td>J22</td> <td>Relay 1</td> <td>Battery on Discharge alarm (BD)</td> </tr> </tbody> </table>	Jumper Number	Signal Name	Pulsar Edge Standard Defaults	J24	Relay 6	Power Major Alarm (PMJ)	J23	Relay 5	Power Minor Alarm (PMN)	J19	Relay 4	Fuse Alarm Major (External FAJ)	J20	Relay 3	AC Fail (ACF)	J21	Relay 2	Rectifier Fail alarm (RFA)	J22	Relay 1	Battery on Discharge alarm (BD)
Jumper Number	Signal Name	Pulsar Edge Standard Defaults																				
J24	Relay 6	Power Major Alarm (PMJ)																				
J23	Relay 5	Power Minor Alarm (PMN)																				
J19	Relay 4	Fuse Alarm Major (External FAJ)																				
J20	Relay 3	AC Fail (ACF)																				
J21	Relay 2	Rectifier Fail alarm (RFA)																				
J22	Relay 1	Battery on Discharge alarm (BD)																				
	<p>Generally, no special controller configurations are required for systems using the ES771 Mid- String Voltage Modules options.</p>																					

Install Pulsar Edge Controller	
Step	Action
5	<p>The 1-Wire serial bus reference: The ES771 modules are referenced to the most negative potential of the DC bus. The controller's 1-Wire bus communication reference is automatically achieved by system shelf design. No jumper settings are required.</p>
6	<p>Securing the Edge-Mounted Controller Note: Skip this section if the unit was pre-installed and no configuration jumper adjustments had to be performed.</p>
	<p>Locate and place the Pulsar Edge into its allocated position located to the left of the leftmost rectifier slot. Although the physical configuration of the controller is different for the various product lines, the controller is located in a similar location.</p>
7	<p>Hold the controller by the controller's chassis using the edges of the sheet metal to support the insertion.</p>
8	<p>Push the controller firmly into the shelf using the handle provided. The LCD assembly can be used on those. Do not press on the LEDs or LCD glass to insert the controller into the shelf. Simultaneous pressing on the DB-9 connector to insert the controller into the shelf is permissible.</p>

Install Pulsar Edge Controller

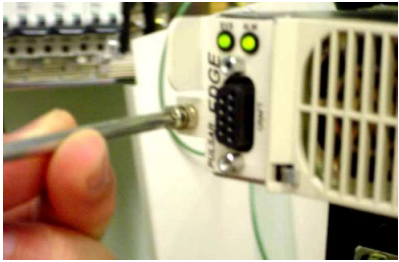
9	Secure the controller in place by tightening the Philips captive fastening screw. Those with displays attached do not have a securing screw. The controller is now installed	
---	--	---

Connect to the Controller

Other than the front accessible serial or USB port, all connections to the Pulsar Edge Controller are made through backplane connections or appropriate cable assemblies to the controller's J1 interface. The Pulsar Edge has been designed to provide all its connections through a single 44-pin connector located to the rear of the controller. Systems are then designed to accept this connection and separate the outputs, inputs, communication, and plant specific items onto individual connectors for external use or to provide automatic connections to core signals. These connectors are typically located at the rear of the shelf but are available in the front in front access configurations.

Systems designed to utilize the Pulsar Edge may provide different interconnects to the controller's inputs and outputs. Although the designs strive for commonality, the specific drawings for the shelves or installation quick start guides must be utilized for identifying the exact input and outputs available for a particular system. The following figures show the input and output connections for one of the available J2007001_L001 CP power shelf.

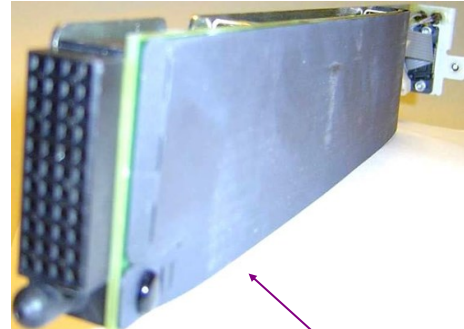

J1 Backplane Interface Connector

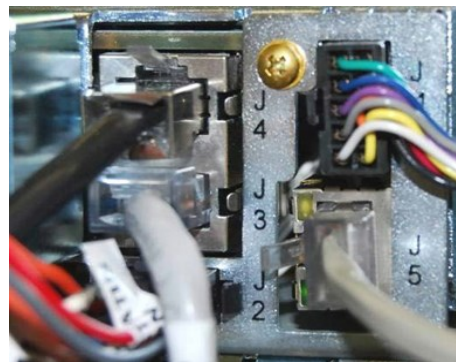
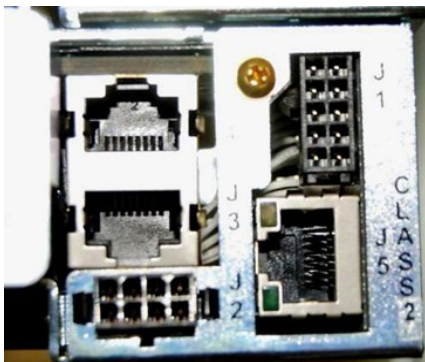

Consult individual product Quick Start Guides for alarm input and output mapping and cable options.

Initial Startup of the Controller

Once all relevant installation procedures are performed as defined in respective system quick start guides and associated system documentation, the system is ready to be powered up.

Step	Action
1	Obtain the appropriate quick start guide for the product to be powered. Thoroughly read through all information and follow all relevant instructions and steps. Verify all connections are as described before applying AC power.
2	If equipped, place all external battery disconnect switches into their ON positions prior to applying AC power.
3	Apply power to the power system.
4	<p>After approximately one minute, all LEDs on all components including rectifiers, converters, the controller, LVD control boards, aux displays, and ES771s (RVMs) should be green.</p> <p>Check the voltage reading at a convenient point on the DC bus to verify the System voltage is approximately -54.5V or +27.2V for 48V and 24V systems, respectively. The controller has a factory default rectifier Float voltage set-point of -54.48V for -48V and +27.24V for +24V systems. Note: If Slope Thermal Compensation (STC) is active or the connected batteries are not fully charged, the bus voltage may be different than the set-point.</p>
5	<p>If this is not the case, access through the Craft port or LAN port must be achieved to further debug the system. Menu details are provided in the next session. The first maintenance operations that should be initiated are the “Clear Events” and “Uninstall Equipment” operations found under Maintenance tab of the home menu of the GUI interface. If present, this operation can also be performed at the front panel at Main → Control/Operations.</p> <p>The controller remembers certain previous system configurations and conditions.</p> <p>Non-existent alarm conditions should clear. If the system LED is not green and the alarm LED is illuminated, review the installation procedure and refer to the troubleshooting section. The controller display should only have the system (SYS) LED illuminated green to indicate “NO ALARMS”.</p>
6	<p>Verifying a simple alarm</p> <p>With the system in a normal operation mode, remove a rectifier from its slot. The controller should illuminate its amber severity LED indicating a missing rectifier. Condition. Return the rectifier to its slot. The controller should update the rectifier status. If the above conditions did not yield the proper results, refer to the troubleshooting section</p>

Craft Port

A GUI very similar to the interface provided by a LAN connection can be obtained locally through the RS232 or USB Craft port using EasyView 2.0, EV2. Once, EV2 has established the connection and is up and running the interface is the same as that provided over the LAN connection. The following describes connecting to the RS232 or USB Craft port using EasyView 2.0. To access the system using the RS232 or USB Craft Port, follow the following basic procedures.

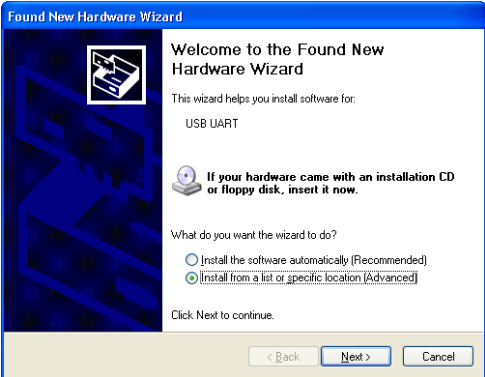
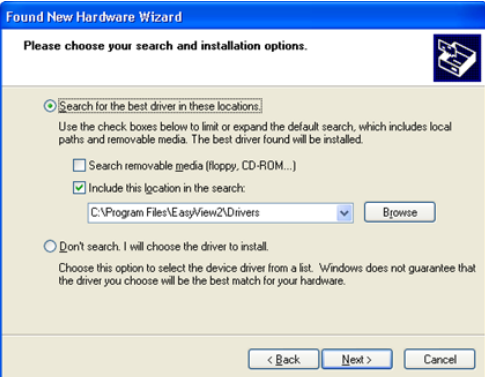
Step	Action
	<p>Note: before connecting the USB or RS-232 port to your PC, be sure that the power system and its output are properly grounded. Discharge Ground (DG) bus must be bonded (connected) to earth ground.</p> <p>CAUTION: damage to the controller may occur if the USB or RS-232 port is connected to a PC when Discharge Ground (DG) bus is not bonded (connected) to earth ground.</p>
1	<p>Down load the latest copy of EasyView 2.0 from the corporate website at omnionpower.com located under the Management Software section.</p>
2	<p style="text-align: center;">Installing the USB Driver for the Pulsar Edge</p> <p>If attaching to a controller with the USB craft port, the driver for the controller must be utilized. Follow the next steps to load the driver. If not using the USB option or are using the RS232 craft connection go to step 3.</p> <p>With the system powered-up, connect the controller to your PC USB port.</p> <p>After Windows recognizes the USB the “Found New Hardware Wizard” window will popup. Click the “Install from a list or specific location (Advanced)” radio button then click the “Next >” button.</p> <div data-bbox="646 982 1128 1356" style="border: 1px solid black; padding: 5px; margin: 10px 0;">  </div> <p>From the “Please choose your search and installation options.” window, click the “Browse” button and select the EasyView2 drivers directory (e.g. C:\Program Files\EasyView2\Drivers) and click on “Next >” button.</p> <div data-bbox="646 1476 1128 1850" style="border: 1px solid black; padding: 5px; margin: 10px 0;">  </div>

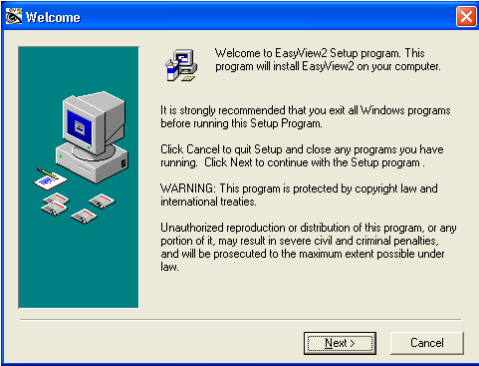
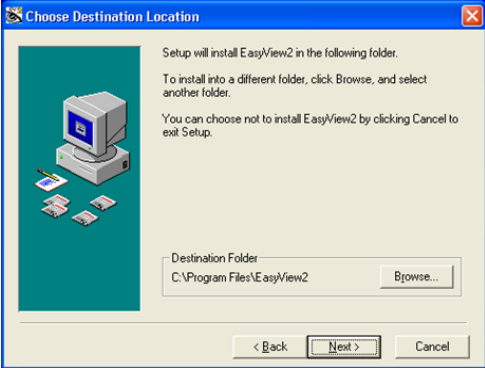

Craft Port (Continued)

Step	Action
	<p>The wizard will load the OmniOn USB UART .inf file and the windows drivers needed to make the controller USB port appear as a virtual COM port on your PC. Click the “Finish” button to close the wizard.</p> 
3	<p>Run the EasyView 2.0 executable EV2.exe to setup the program on your PC. Find and double click on EV2setup.exe. Click “Next >” at the “Welcome” window.</p>  <p>Choose Destination Location, default is C:\Program Files\EasyView2, then click “Next>”.</p>  <p>Backup Replaced Files. It is recommended that you do this if you have previously installed EasyView2, then click “Next >”.</p>

Craft Port (Continued)

Step	Action
3	<div data-bbox="646 346 1128 718" style="border: 1px solid black; padding: 5px; margin-bottom: 10px;"> </div> <p data-bbox="321 739 1507 840">Select the components to be installed. Selecting all items is recommended. Selecting “CP841 Pulse Edge Support” will cover the various controller configurations including the CP841A, SPS841A, NE841A, and QS841E controllers. Then select “Next >”.</p> <div data-bbox="646 865 1128 1236" style="border: 1px solid black; padding: 5px; margin-bottom: 10px;"> </div> <p data-bbox="321 1276 1515 1339">Select the program manager group, then click “Next >”. The installer will install EasyView2 onto your PC. Click the “Finish” button to close the installer.</p> <div data-bbox="646 1373 1128 1745" style="border: 1px solid black; padding: 5px;"> </div> <p data-bbox="321 1780 1523 1879">Note: The driver (.inf file) for the OmniOn USB UART is found in the \EasyView2\Drivers directory. This will be requested when the Windows detection that the controller USB port has been connected to the PC</p>

Craft Port (Continued)

Step	Action								
4	<p>Once the program is running a screen similar to the following should appear. Configure as required.</p> 								
5	<p>It is not necessary to enter a "Username". Enter one the appropriate password and click the Login button. There are three levels of access through the port; Read-Only, Read/Write, and Read/Write with password management privileges. Passwords defaults for the Craft port as well as other remote access means default as follows</p> <table border="0"> <thead> <tr> <th data-bbox="321 1087 1104 1113">Access</th> <th data-bbox="1104 1087 1534 1113">Default Password</th> </tr> </thead> <tbody> <tr> <td data-bbox="321 1129 1104 1155">User (Read-Only)</td> <td data-bbox="1104 1129 1534 1155">lineage</td> </tr> <tr> <td data-bbox="321 1171 1104 1197">Super-User (Read/Write)</td> <td data-bbox="1104 1171 1534 1197">super-user</td> </tr> <tr> <td data-bbox="321 1213 1104 1239">Administrator (Read/Write/Password Administration)</td> <td data-bbox="1104 1213 1534 1239">administrator</td> </tr> </tbody> </table> <p>A status screen, similar to that below, will popup once the program is launched. This screen provides the indications for the version numbers of the web page files, "pages.web", which is presently supported as well as the version of EasyView 2. Note:</p> <p>an individual web page file can be replaced with a later version of the file in the appropriate directory using the same name to update the software package.</p> 	Access	Default Password	User (Read-Only)	lineage	Super-User (Read/Write)	super-user	Administrator (Read/Write/Password Administration)	administrator
Access	Default Password								
User (Read-Only)	lineage								
Super-User (Read/Write)	super-user								
Administrator (Read/Write/Password Administration)	administrator								

Craft Port (Continued)

Step	Action
6	<p>A Home page similar to that follows should appear. This page should be nearly identical to that seen if the LAN access GUI was utilized. These pages are described in the next section of the manual.</p>

Web Interface

The Pulsar Edge integrated 10/100Base-T port supports standard protocols over TCP/IP like SNMP, TCP/IP, FTP and Telnet. It has an integrated HTTP web server that serves up web pages to remote PCs using standard web browsers. Once connected to the network, simply typing the IP address assigned to the controller in the browser will serve up the log-in screen. The same “web page- like” interface can also be achieved through the serial Craft port connection by using the EasyView2 GUI program. The controller also supports a T1.317 command line through both connections.

Specific systems like the CPS6000 Series II provide a front panel within LCD user interface option which provides access and control of the majority of the features and settings in the controller. This user interface and menu structure is described in the next session. The front panel menu structure and terminology utilized is very intuitive and map over to the web. The web interface is common to all Pulsar Edge controllers and will be described in more detail. Web pages are updated for functionally and aesthetics. Thus, some of the screens shown may be slightly different than those served up by your Pulsar Edge.

LAN Port as the Craft Port

The 10/100Base-T port can be configured to also be used as a Craft port when the connection is not plugged into the site’s LAN. A PC can be directly connected to the LAN connection on the controller and its standard Web browser can be used to locally access the system. This is achieved when the DHCP server mode of operation for the LAN port is utilized. While the Craft port is operating as a DHCP server, it must never be plugged into the building or surrounding LAN.

Note: this port comes defaulted in the DHCP Client mode. If the site’s LAN network is setup properly the controller will automatically obtain an IP address from the network while in the DHCP Client mode and the controller can be simply accessed by typing in its correct IP address.

To access the system using the LAN as the Craft Port, follow the following basic procedures.

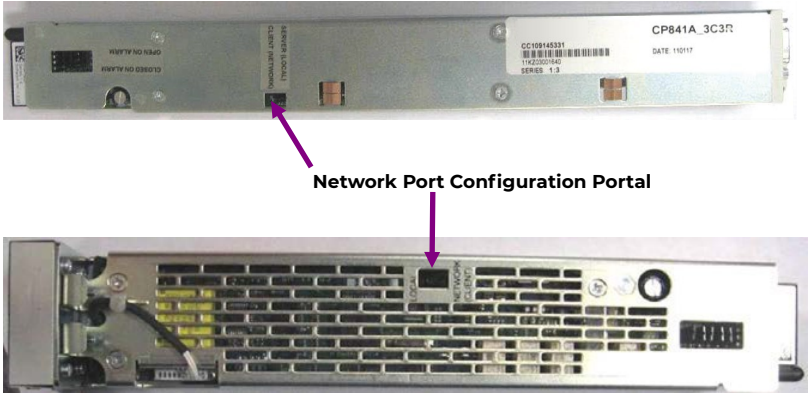
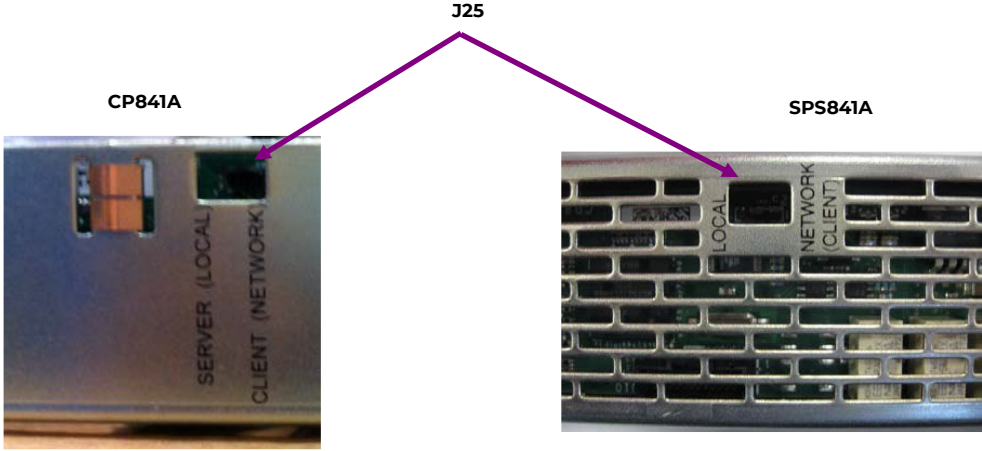
<p>1</p>	<p>To use the Ethernet port locally as a Craft port the controller needs to be configured as a DHCP Server. First remove the controller from the shelf to place the controller into DHCP server mode. Locate the Port configuration jumper portal</p> 
<p>2</p>	<p>Place the controller in appropriate location and set jumper J25 into to the DHCP Server position which is the "local" position. DHCP Server mode of operation is from pins 2 to pin 3. Connecting the controller to the intranet J25 must be set to the Network (Client) position which is from pins 1 to pin 2. Network (Client) is the factory default configuration. Use of an insulated tool to set the jumper is preferred.</p> 
<p>3</p>	<p>Reinsert the controller back into system shelf. The controller must be rebooted when changing the mode of operation of the network port. This is achieved through the reapplication of power. When this process is performed the controller accepts the new Ethernet port configuration. The rebooting process takes approximately 2 minutes.</p>
<p>4</p>	<p>Attach the LAN cable between the controller's LAN connection, RJ45 (J5), located at the rear of the shelf to the appropriate Ethernet port on the Craft PC.</p>

Web Interface (Continued)

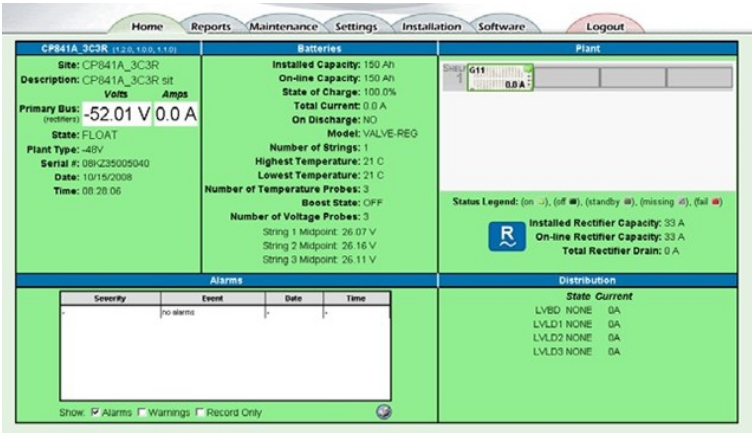
5	<p>Open the PC's browser and enter the controller's WIP (Working IP address) as the destination address. This address should be http://192.168.2.1. The Pulsar Edge has HTTP capabilities and should begin to return appropriate system representative web pages.</p>								
6	<p>Using a standard browser, a login page similar to that depicted below should be served up by the Pulsar Edge controller.</p>  <p>There are three levels of access through the port; Read-Only, Read/Write, and Read/Write with password management privileges. Passwords defaults for the Craft port as well as other remote access means default as follows:</p> <table border="1"> <thead> <tr> <th data-bbox="253 806 889 835">Access</th> <th data-bbox="889 806 1541 835">Default Password</th> </tr> </thead> <tbody> <tr> <td data-bbox="253 846 889 875">User (Read-Only)</td> <td data-bbox="889 846 1541 875">lineage</td> </tr> <tr> <td data-bbox="253 886 889 915">Super-User (Read/Write)</td> <td data-bbox="889 886 1541 915">super-user</td> </tr> <tr> <td data-bbox="253 926 889 955">Administrator (Read/Write/Password Administration)</td> <td data-bbox="889 926 1541 955">administrator</td> </tr> </tbody> </table> <p>Once the password is entered a screen similar to the following, similar to that with EV2, should appear.</p> 	Access	Default Password	User (Read-Only)	lineage	Super-User (Read/Write)	super-user	Administrator (Read/Write/Password Administration)	administrator
Access	Default Password								
User (Read-Only)	lineage								
Super-User (Read/Write)	super-user								
Administrator (Read/Write/Password Administration)	administrator								

Security Levels/Passwords

The Pulsar Edge supports three levels of access: (User, Super-User, and Administrator). Password defaults can be changed only by a user of administrator privileges.

User security level:

- Can view almost every parameter in the system
- Can change only a few parameters considered to be of standard maintenance practices
- Default password: lineage

Super-User security level:

- Can do everything the user can do
- Can change any configuration parameter in the system (except passwords)
- Default password: super-user

Administrator security level:

- Can do everything the super-user can do
- Can change passwords
- Can upgrade controller software
- Default password: administrator

Basic Controller Configuration

Once the system is up and running there are only a few configurations that are necessary depending on your application and the controller utilized for the application. The Pulsar Edge families of controllers are a multiple micro-processor based unit with volatile and non-volatile memory. These units have been factory preconfigured with standard or customer specific configuration default settings for all features and thresholds. Many systems shipped from the factory all ready have the controller installed, configured, and tested for the system it resides. Installation and much of the configuration of the system controller may not be required. The date and time is generally set at factory test to Central Standard Time zone.

Controllers with customer specific configuration defaults are also available. These units will be assigned a unique apparatus code for ordering and management. A configuration template is available to facilitate this process. OmniOn predefined industry standard factory defaults are utilized for the Pulsar Edge standard controllers. Although the configuration default files are permanently stored until they are replaced, all configurable parameters and thresholds can also be reconfigured or modified as needed in the field. These items are then stored in non-volatile memory.

However, a user can always return to factory programmed configuration by initiating the “Loading Defaults” operation for a specific battery type.

The minimum items to configure for basic system operation are:

- Float Set-Point (And associated alarms described in next section)
- Battery Type and number of strings
- Date
- Time

The Pulsar Edge is designed to support multiple battery technologies. These Generic technologies include:

- Valve-Regulated Lead Acid (Valve-Reg)
- Flooded Lead Acid (Flooded)
- Lithium Metal Polymer (Li-LMP)
- Lithium ELITE (Li-ELITE)
- Nickel-Cadmium (Ni-Cd)

Standard float values, alarm thresholds, and other functions are set as defaults for each of these battery types that can be modified in the field as desired. The Pulsar Edge also provides a list of industry standard batteries that are linked to these technologies and share the standard defaults. Batteries can be added or deleted from this list as required through the use of the controller's remote interfaces.

The Pulsar Edge has been factory pre-configured with the generic Valve-Regulated Lead Acid (Valve-Reg) battery as the standard configured battery model. All associated configuration items for the "Valve-Reg" battery type are utilized. Thus, the default system float voltage setting and alarm thresholds are configured assuming the power system contains VRLA batteries that require an uncompensated float voltage of $-54.48V$ (48V) or $+24.24$ (24V) as observed during the power-up procedure.

Basic configuration items such as the battery type, float set-point, date, and time, and site ID can be reconfigured in the field from through remote means. Many of the items are found on the "Installation" page. Consult the next section for additional details for changing specific items.

This page intentionally left blank

Operation

Overview

The Pulsar Edge family of controllers provides system monitoring and control features for CP, SPS, and other OmniOn rectifier based power systems. These controllers monitor and control system components including rectifiers and distribution modules via a multi-drop RS485 digital communications bus. System status, parameters, settings, and alarm thresholds can be viewed and configured from the controller's front panel display. Assignment and configuration of alarm inputs and output relays can be performed from a laptop computer directly connected to the front access local RS-232 Craft port or directly connected to the Ethernet port when the controller is configured to operate in a DHCP Server mode.

Access can also be obtained remotely through a network connection to the World Wide Web (internet) or your enterprise network (intranet). A connection through an optional external modem connected to the controller's RS232 port is also possible.

This section describes the controller features, functions and alarms primarily from the perspective of a user utilizing the Web interface. Depending on the end-system there are configurations using the Controller Edge controller that provide a user interface with LCD and keypad interface. Description of this interface will be provided. However, details will be described through the web interface perspective since the front panel interface functionality is a subset of that available through the Web interface. Access to all these features is also available through the remote interfaces including EasyView2 and directly with the T1.317 machine interface. EasyView2 is the OmniOn GUI provided for local serial port or remote MODEM access. It is available at the "Downloads" section found on the company's web site. EasyView2 presently supports all the latest OmniOn controllers. The web interface will be the assumed interfaces of choice. The web pages are also used by the EasyView2 operating over the asynchronous serial port. This section focuses on describing the controller from a user accessing the controller from the Web since it is the most available interface that only requires the use of a standard browser and no additional PC or computer hardware. The descriptions and items contained within the Web pages are applicable to respective feature implementations in EasyView2.

Front Panel Display Option

The Pulsar Edge controller has configurations that support a front panel interface consisting of an LCD and capacitive touch user interface. These configurations are found in the Slim Line Power System (SPS) with the SPS841A controller and in the CPS6000 Series II platform with the QS841E controller configurations. The QS841E is also utilized in the family of Infinity NE-S converter shelves (ex: 663) that utilize a display option. Following are representative views of the interface on these units. In the SPS product line the LCD assembly integrates the local USB craft port into the assembly. In the CPS6000 Series II and converter products, the USB craft port is not part of the assembly mounted to the distribution door but part of the standard controller assembly. In either case the front panel operation is the same.

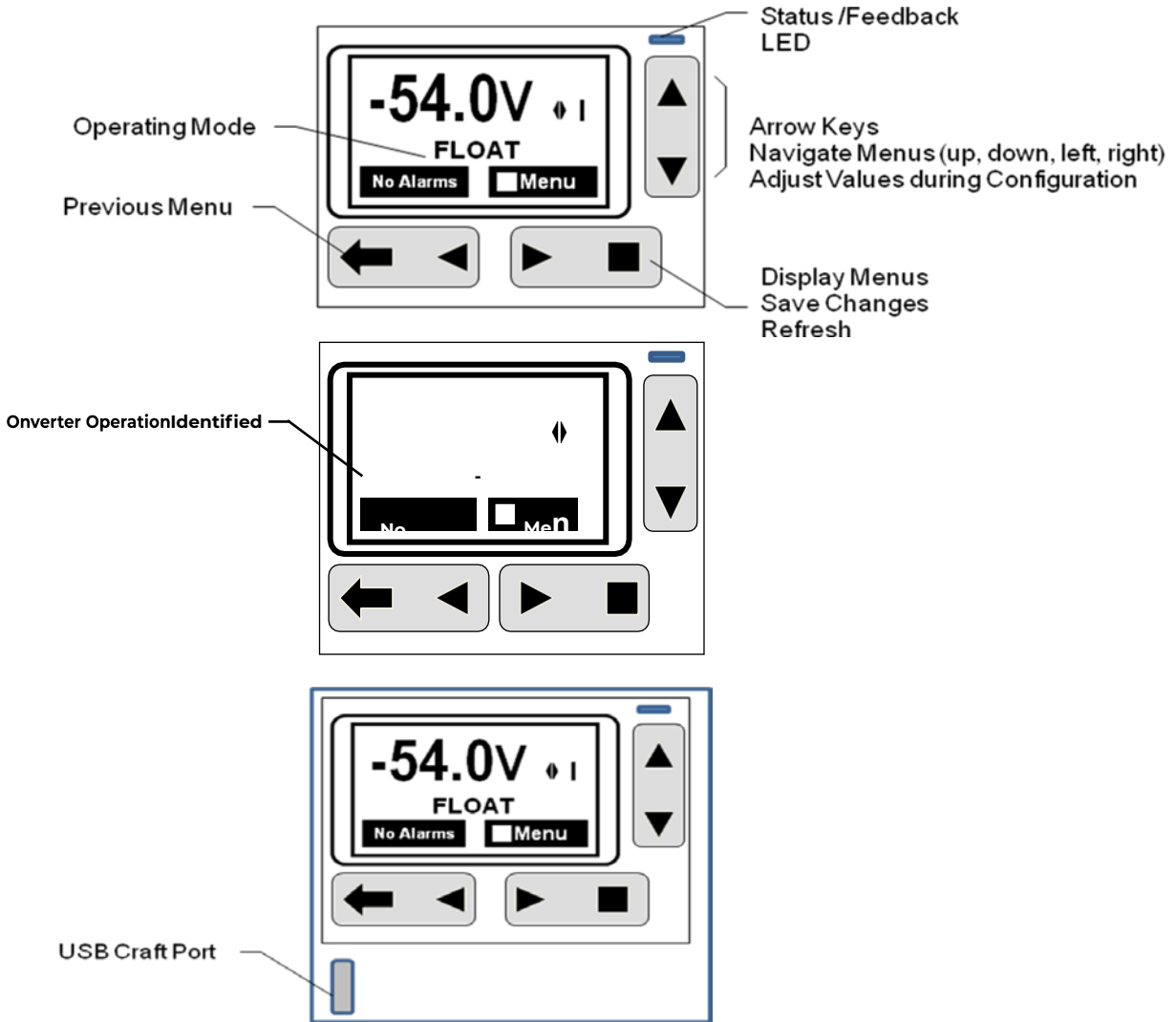

Figure 8 Pulsar Edge Front Panel Display Assembly

The previous figure shows depictions of the front panel display in a 48V CPS6000 Series II rectifier system, a 48V Infinity NE-S converter output system, and a 48V SPS rectifier system. The display defaults with the system voltage (V) displayed on the main menu. Total system load (I) can be easily obtained by toggling the display using either ◀▶ keys. The text area underneath the voltage and current numbers provide the overall operating mode of the system. In converter only systems, this text will be fixed and say “converter plant”.

System Status Display

LCD Backlight

The Pulsar Edge controller family incorporates an alarm sensitive back-light indicator to help assist in providing a clear indication of the system status. Severities of alarms can be configured through the remote interfaces. Following is a basic description of the backlight functionality.

	<p>The incorporated display technology can support a wide range of backlight colors. Present implementation supports three basic colors to indicate the alarm severity present in the system: Green, Amber, and Red. The highest severity in the system will take precedence.</p>	
Status Function Condition		
green	Normal	Normal operation, no alarms, inputs and outputs are in their normal range.
red	Major Alarm	High severity. Generally assigned to alarm to indicate a Power affecting condition. Immediate attention required.
amber	Minor Alarm	Medium severity. Generally assigned to alarm to indicate a non-power affecting condition. Attention eventually required.





Status LEDs

The Pulsar Edge controller family provides two separate LED indicators that can be used to provide a high level first glance local indication at the site of the status of the power system and its monitored inputs. These LEDs can be configured to assist in providing more specific indications of the system status. The LEDs provided are used to provide specific indication concerning the system status as well as a separate indicator for an assigned alarm or alarms. The alarm LED has factory assigned defaults as indicated in the table below. However, the assignments to alarms can be customized in the field using the remote interfaces.

LED	LED Color	Status	Condition
System OrSeverity	green	Normal	Normal operation, no alarms, inputs and outputs are in their normal range.
	red	Critical Alarm	Highest severity. Generally assigned to alarm to indicate a Power affecting condition. Immediate attention required.
	red	Major Alarm	High severity. Generally assigned to alarm to indicate a Power affecting condition. Immediate attention required.
	amber	Minor Alarm	Medium severity. Generally assigned to alarm to indicate a non-power affecting condition. Attention eventually required.
Alarm	BD	Not Illuminated	System above configured Battery on Discharge (BD) threshold.
		amber	This state is not assigned by the present default configuration.
		red	System equal to or below configured Battery on Discharge (BD) threshold.

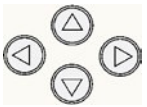
Menu Navigation Buttons

The Pulsar Edge family of controllers has six capacitive touch buttons to use to navigate through a structured menu system. The buttons serve multiple purposes depending on the screen a user is at. These functions are summarized below.

Buttons	Description	
	Direction Buttons	In the Menu, the ◀▲▶ direction buttons navigate to make a selection. A black box highlighting a menu item indicates that the item has sub-menus.
	Parameter Change	When changing a system parameter, the ▲▼ buttons increase or decrease the value of the parameter.
	Enter Button	Enters a sub-menu or confirms a parameter change. From the Home Page only, goes to the top level Main menu.
	ESC Button	Goes up one menu level or exits a parameter change without saving.

Front Panel PIN

The Pulsar Edge controllers have the ability to restrict certain types of access from the front panel of the unit. It has the ability to enforce a four-digit Power Identification Number (PIN) requirement for users of the front panel for certain control/operations and configurable items. These control/operations and configurations are generally considered the items that should only be done during initial install or by specific personnel. This feature is shipped disabled from the factory in the standard Pulsar Edge controller offering and must be enabled by a remote user with administrator level privileges. When the front panel PIN feature is enabled, the factory default for the PIN is 0000. Each position of the password is configurable between 0-9. A sample screen like that following is required for PIN access.



The up, down, left and right arrows are used to enter the appropriate password. Upon entering a correct PIN the following momentary screen shows up and then disappears leaving the user at the menu location prior to entering the PIN.

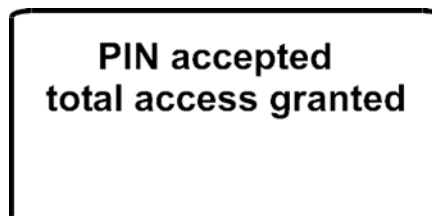

A user must enter the PIN for items that generally are not deemed as functions of a typical maintenance routine. It is assumed that the majority of the configured thresholds and system operational features will not be changed through a maintenance routine. Thus, entering the correct PIN will be required in order for these specific types of parameters or features to be modified in the field. These same rules are implemented when accessing through the Craft port. In addition to Configuration items, there are some Control/Operations that also require the PIN. These are shown below.

Control/Operations that require PIN

1. Clear History
2. Clear Statistics
3. Disconnects – Manual disconnect/reconnect of any LVLD/LVBD
4. Enter Boost

Control/Operations that do not require PIN

1. Lamp Test
2. Restart Rectifiers
3. Uninstall Equipment
4. Start Battery Test
5. Start Alarm Test
6. Load Factory Defaults
7. Cut-off Audible Alarm

All configuration items from the front panel require PIN access except for a few.

Configuration not requiring PIN

1. Battery Type
2. String Battery Capacity (AH)
3. Number Of Battery Strings
4. Manual Discharge Test Type
5. Manual Test Duration
6. Manual Test Check Battery Alarm Voltage Threshold
7. Battery Test Rectifier Voltage
8. System Date Format
9. System Date
10. System Time Format
11. System Time
12. Automatic Daylight Savings Feature
13. Display Contrast
14. Temperature Display Units
15. Alarm Test Feature
16. Alarm Test Relay Duration and Relay

Once a user enters the PIN, total front panel access is allowed for:

- As long as the user remains in menus other than the default menu and/or
- The default display has remained on the front panel for more than user configurable time-out value. The Pulsar Edge family of controllers has a factory configured default of 120 minutes. This time is adjustable between 1-120 minutes in 1 minute increments. 120 minutes is the factory default.
- An internal counter shall be kept and reset if the user leaves the default menu and returns to others menus before the time-out period is reached

Front Panel Menus

Feature content at the front panel is functionally divided at the Pulsar Edge’s Main Menu into the following categories:

Alarms

Warnings Status

Control/

Operations

History

Configuration

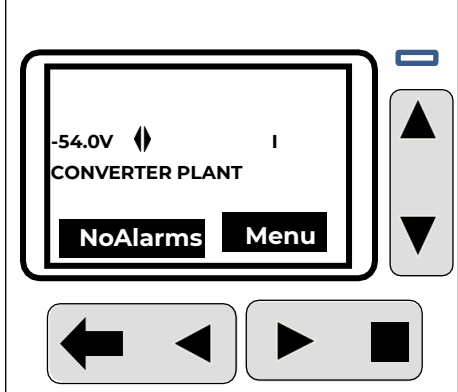
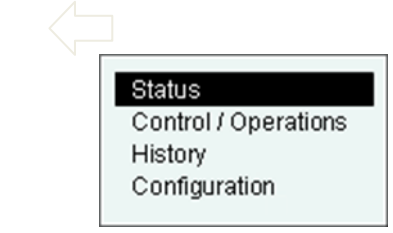
<p>Front Panel Default Menu</p> 	<p>The front panel default screen displays the system DC output bus voltage. Using the ►◀ keys allows the system load current to be displayed.</p> <p>The operating mode of the system is also displayed. Possible operating modes are: Float, Battery On Discharge, Boost, Float-Temp Comp etc. In converter systems, the text is fixed to “converter plant”.</p> <p>An alarm soft-key as well as the backlight will indicate when alarms are present. Pressing the i will access the alarm cut-off as well as the alarms and warnings present in the system.</p> <p>Pressing the □ button accesses the main menu and the feature categories previously listed.</p>
<p>Main menu</p> 	<p>Access to alarms, warnings, equipment status detail, basic control and operations for maintenance purposes, and system configuration can be obtained.</p> <p>Note: the Pulsar Edge has the ability to have a front Panel Password that limits configuration as well as some operations. A person with administrator level access can enable this feature through the remote interfaces. Standard Pulsar Edge controllers are shipped from the factory with this feature disabled.</p>

The following figures provide a menu flow map for each primary category. This information is followed up with brief descriptions of each of the menu items. Alarms and Warnings are not hierarchal mapped and are presented in chronological order of occurrence when they are present. No Active Alarms or No Active Warnings will be displayed when they are no alarms or warnings detected by the controller.

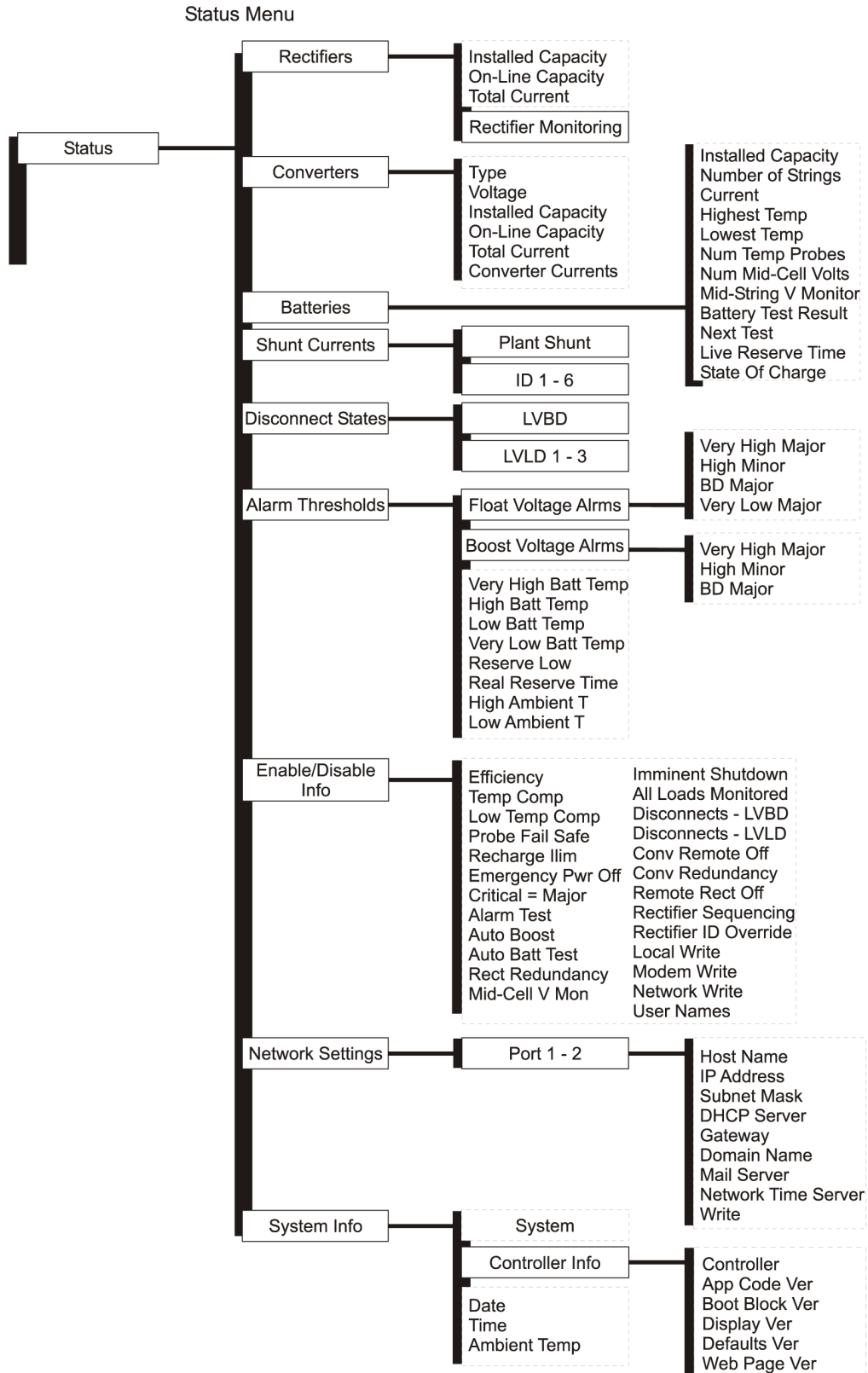

Figure 9 Pulsar Edge Status Menu

Control / Operation
and
History Menus

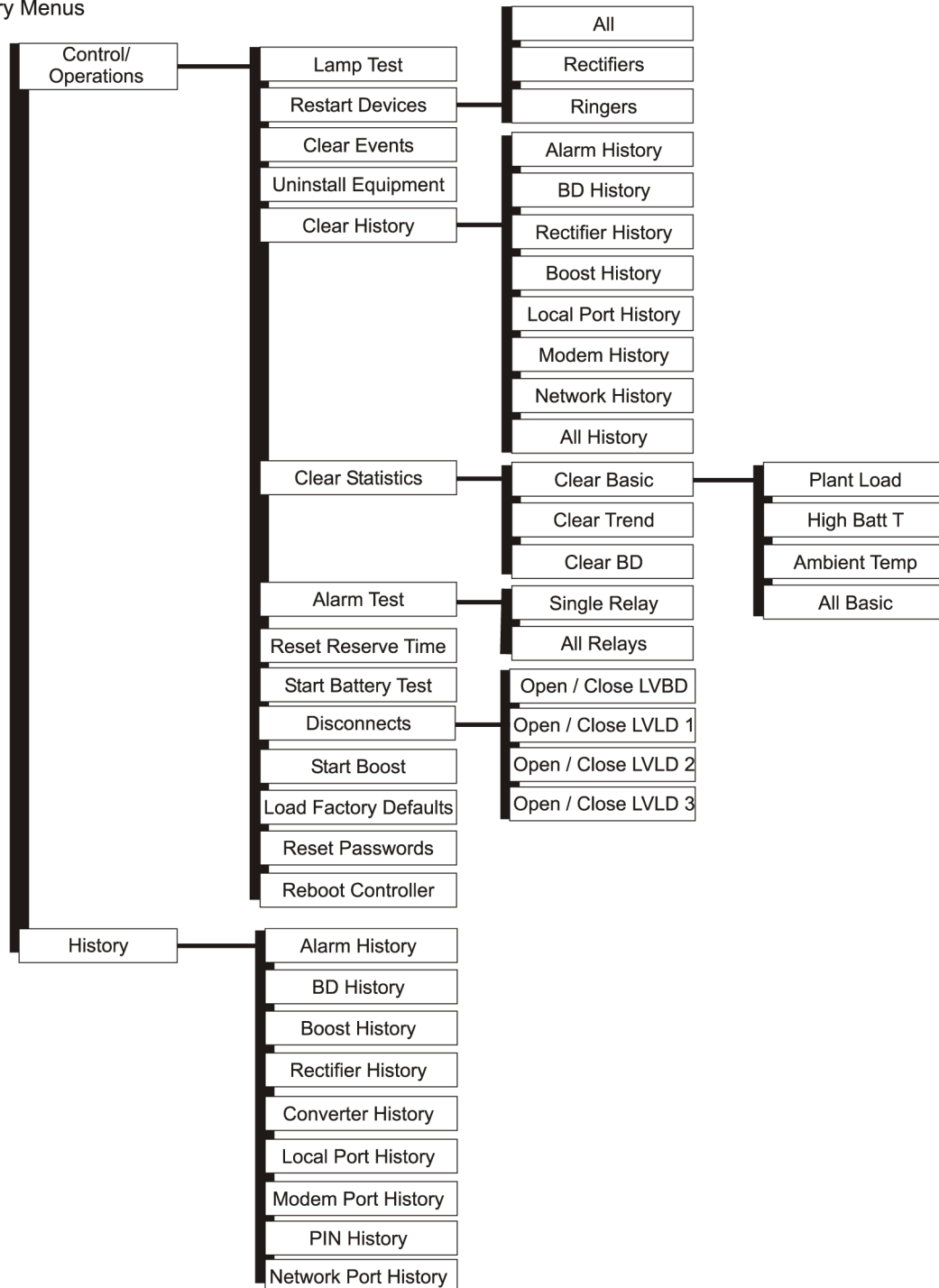
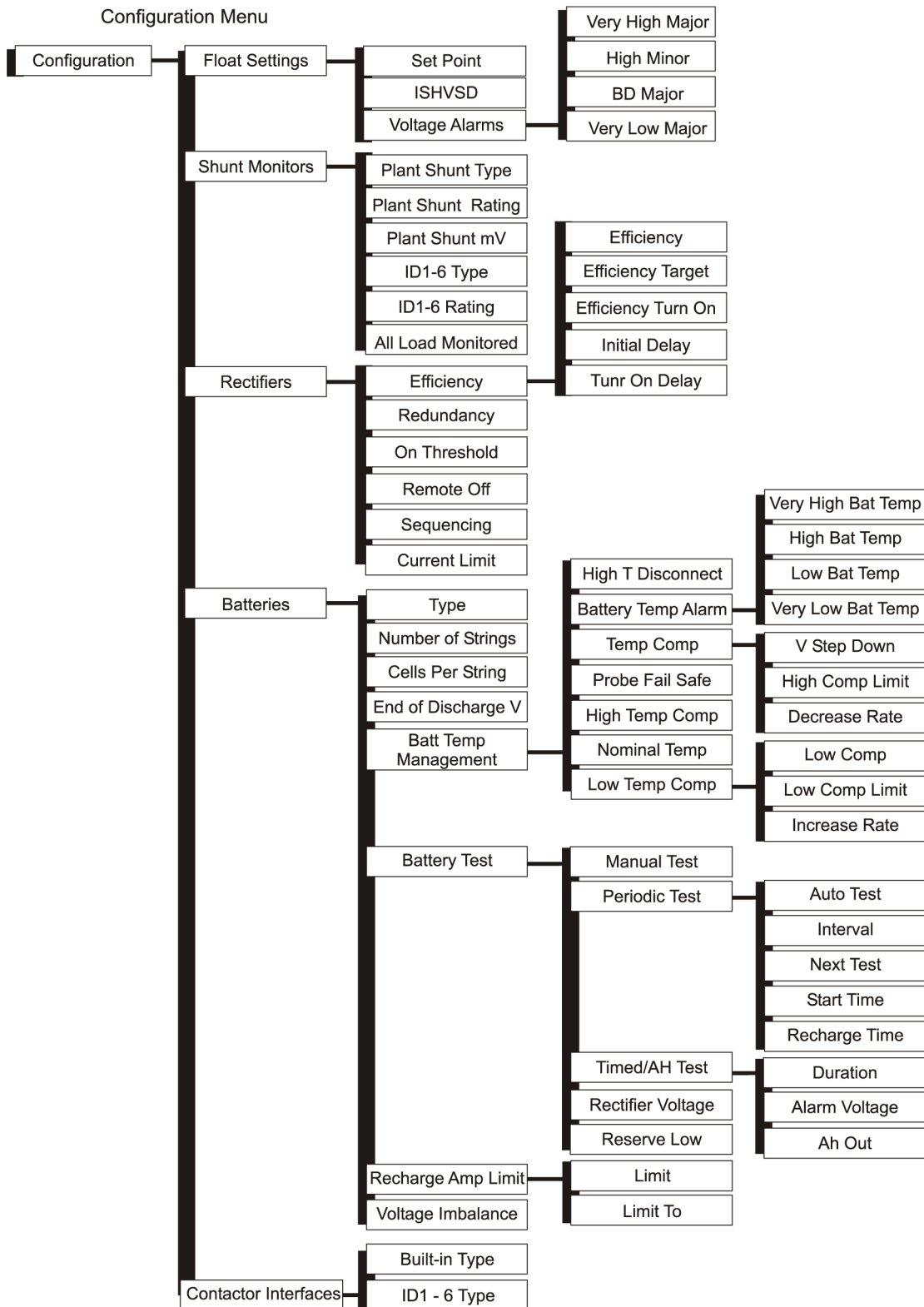

Figure 10 Pulsar Edge Control / Operations and History Menus



Continued on
Next Page

Figure 11 Pulsar Edge Configuration Menu (part 1)

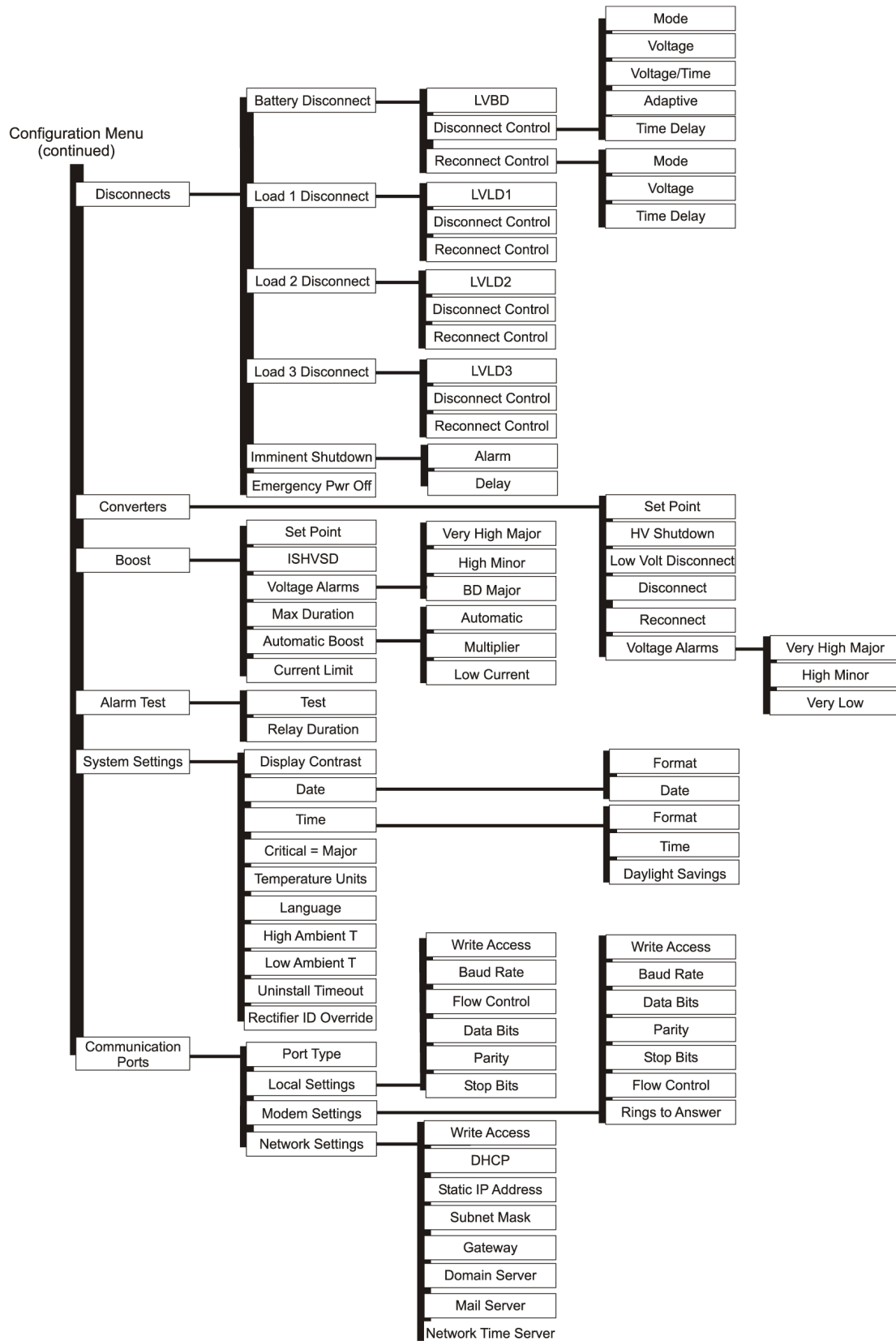
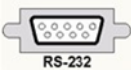



Figure 12 Pulsar Edge Configuration Menu (part 2)

Local and Remote Access Ports

The Pulsar Edge provides ports for both local and remote access. Access to these ports depends on the specific Pulsar Edge controller configuration. Various versions of the Pulsar Edge provide front access through a local DB-9 RS232 asynchronous serial port. Asynchronous RS232 connectivity is also available through an RJ45 receptacle in specific controller configurations. A USB terminal connection is also provided in specific controller configurations. The Pulsar Edge's integrated Ethernet port can also be configured to for local craft port use. A standard RJ45 connection located is provided for access. Depending on the system, this connection can be located at the rear or front of the shelf or system. Following are sample depiction of these interfaces.

Port	Description
<p>Front Panel Serial Craft ports J6</p>   	<p>A laptop PC can be connected to standard DB9 connector J6 to provide a ground-referenced RS-232 serial or to the available minis series-B USB connection on certain configurations for local craft access. EasyView 2 or the T1.317 command line can be used to facilitate this access. Controller with RS232 ports can also be configured and used with external modems.</p>
<p>Rear J5</p>	<p>Applications utilizing the Pulsar Edge controller provide a standard RJ-45 Ethernet connector, J5, to access the integrated 10/100 Base T network connection. This connection can be at the rear or at the front of the system as shown. It can be used for remote monitoring or as a local Craft port. In the remote monitoring applications, OmniOn Manager or other SNMP based programs used for web-based remote access and network management can be used.</p>

Web Pages

Using a standard browser or the EasyView 2 graphical user interface program provides the best mechanism for accessing the controller. All items accessible from the front panel are available through these interfaces. In addition, features like custom alarm mapping are available through the remote interfaces but is not available through the front panel. In general, front panel items are mapped over and are easily identified within the web page menu tabs.

Front panel "Configuration" found in Web page "Settings"

Front panel "Control/Operation" found in Web page "Maintenance"

Front panel "Status/History" found in Web page Home Page/Settings/Reports

Controller features and operation will be identified using the web page perspective. Once connected through the network port or the serial port using the EasyView 2 GUI, a Home page similar to that below is presented. The Home Page tabs are partitioned as follows:

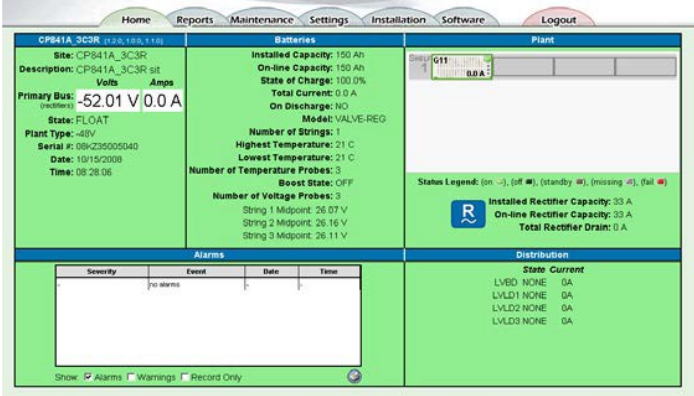
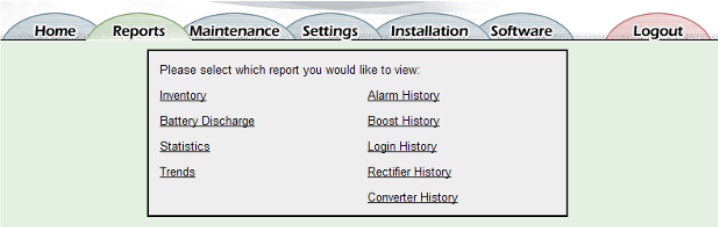
<p style="text-align: center;">Home</p>	<p>Main login page with representative graphic of the power components depicted: the number of shelves, rectifiers in place with their appropriate outputs, empty slots, and an indication of which rectifiers are in alarm or Off. High-level summary of Batteries, Distribution, Alarms present, and controller are shown. There are tabs that take you to specific features. These tabs are the Home, Reports, Maintenance, Settings, Installation and Software.</p> 
<p style="text-align: center;">Reports</p>	<p>The reports tab provides access to various system reports such as Event History, Inventory, Statistics, Trends, and Battery on Discharge. Individual group event histories for Alarms, Boost, Login, Rectifier, and Converter are also available.</p> 
<p style="text-align: center;">Maintenance</p>	<p>Allows access to common operations performed during the maintenance or installation of the system or its components. Operations include restarting rectifiers/converters, starting alarm or battery tests, asserting boost, clearing history and statistics, clearing latched events and missing equipment, placing rectifiers/converters in and out of Standby, Reboot, and performing an SNMP Trap test. A T1.317 Terminal button establishes a quick Telnet session to the controller where the T1.317 command interface can be utilized.</p> <p>The “Load Defaults” button loads the factory configuration defaults installed in the controller. All previous configurations will be overridden using this command. Standard controller configurations will use the standard factory defaults. Custom controllers utilize specific customer driven configurations.</p>

<p>Maintenance</p>	
<p>Settings</p>	<p>Items in this menu are used to configure all the individual system parameters, features, and thresholds. Configuration items are arranged by System, Reserve, Power, Communication, and Programming categories.</p>
<p>Installation</p>	<p>This tab allows a quick configuration of the primary items needed to be set for a site. These basic items include: selecting the battery type, date, time, and the site ID. The Pulsar Edge can support two front panel languages. English, Spanish, French, and German are a few languages supported by the controller. Language support for web pages are will be available in the near future. Consult appropriate sales or technical support for Language file availability</p> <p>This page is provides the minimum configuration for configuring the Pulsar Edge for Basic system operation.</p>

<p style="text-align: center;">Installation</p>	
<p style="text-align: center;">Software</p>	<p>This tab allows a backup of the controller's configuration, an ability to restore a site to a previously saved configuration, and the ability to upgrade the various components of software in the controller.</p>

Web pages are continuously being improved for usability as well as for features. The best method of understanding the functions and features available through the pages over the network or Craft port is by clicking on the individual items and exploring to obtain familiarity with the items. The structure and terminology utilized in this controller's web interface are consistent with those in the other controllers of the family. Thus, familiarity with one provides familiarity with all.

More details on the front panel capabilities and Craft port web pages are found in the controller section.

Web Interface Structure

As with the front panel display, a map can be created for the items located in the web page tabs. Access to the main menu starts at the default Home screen described previously. The following figures provide a menu flow map for each primary tab. This information is followed up with brief descriptions of the items that show up in the screens. Alarms and Warnings are not hierarchal mapped and are presented in chronological order of occurrence when they are present. No Active Alarms or No Active Warnings will be displayed when they are no alarms or warnings detected by the controller.

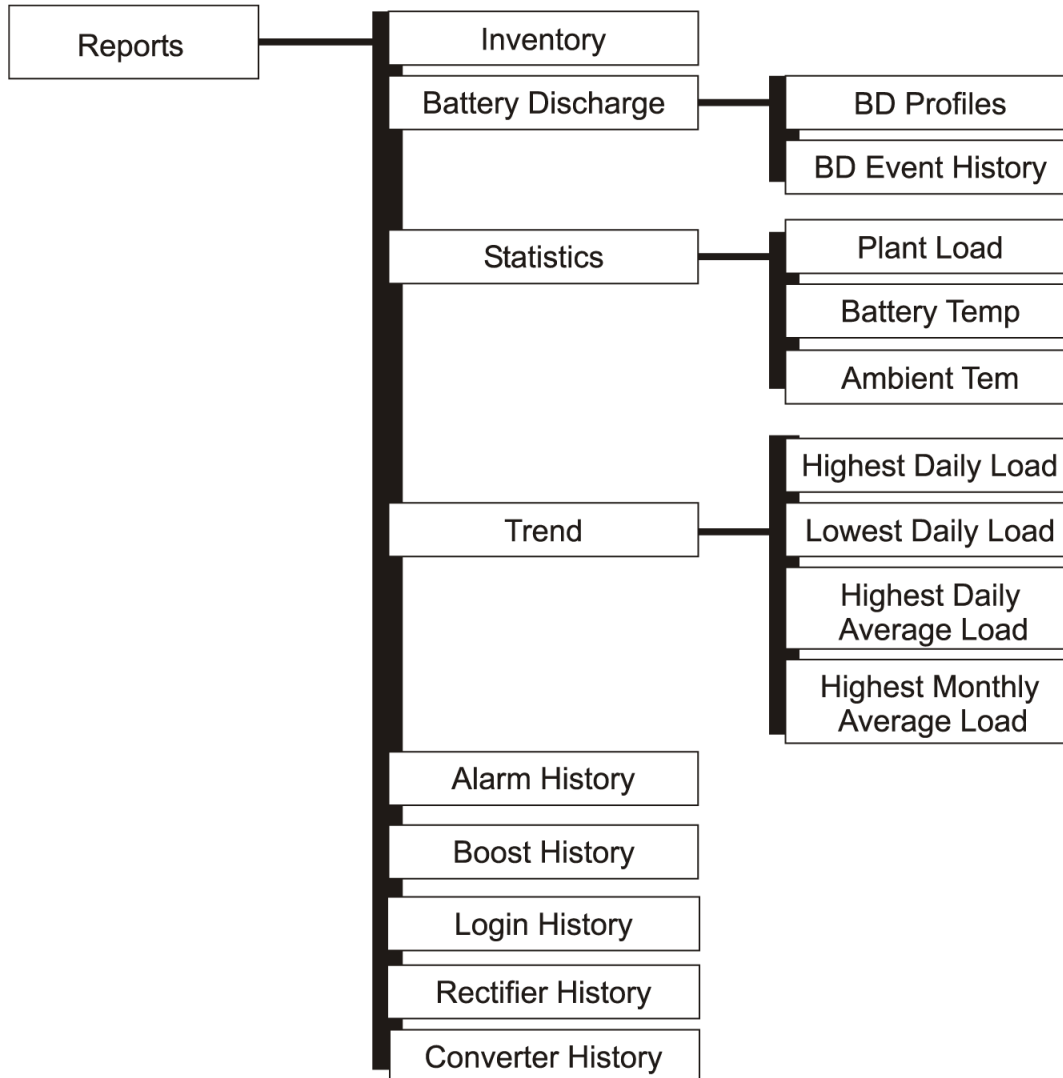

Figure 13 Reports Menu

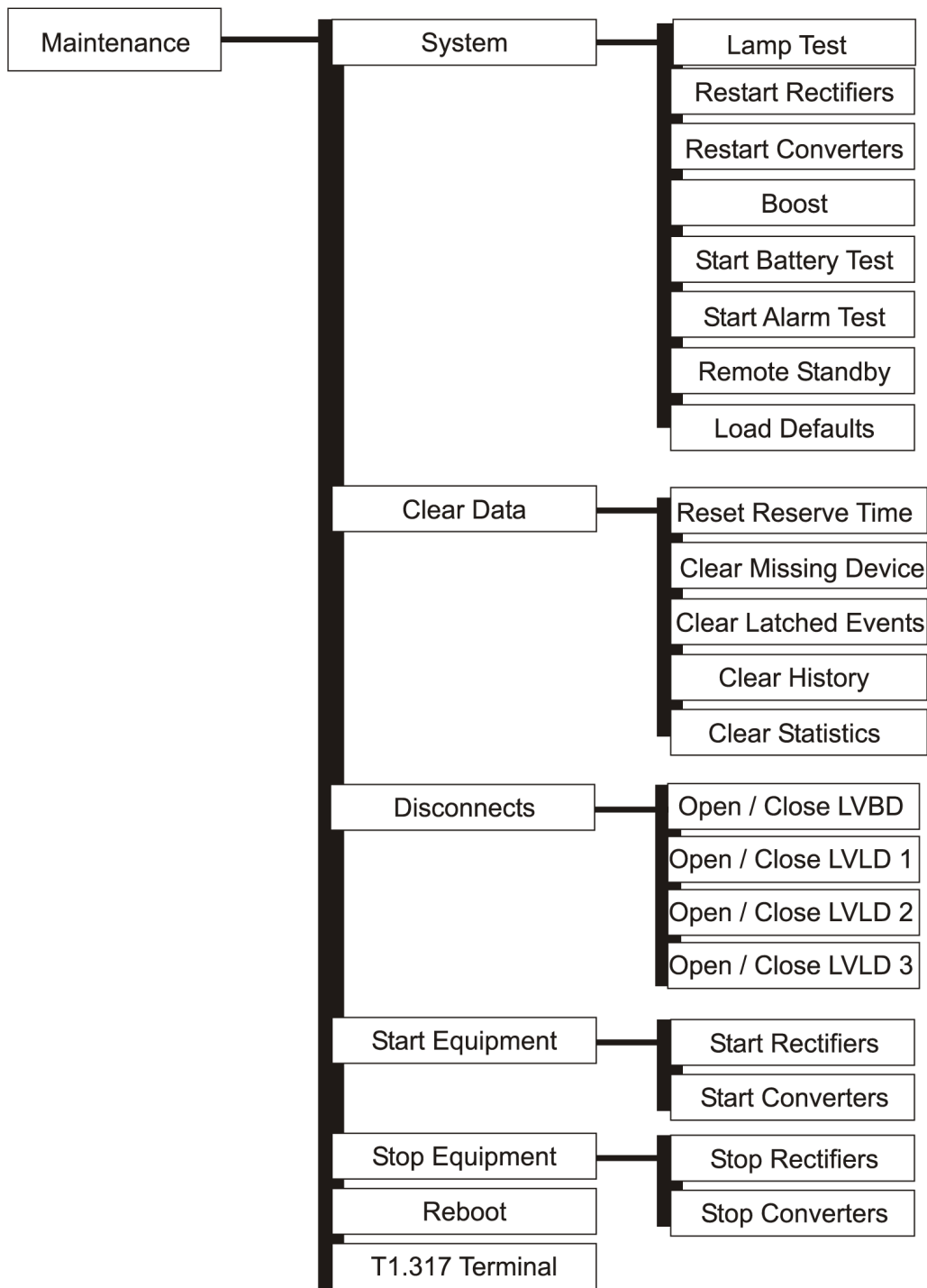

Figure 14 Maintenance Menu

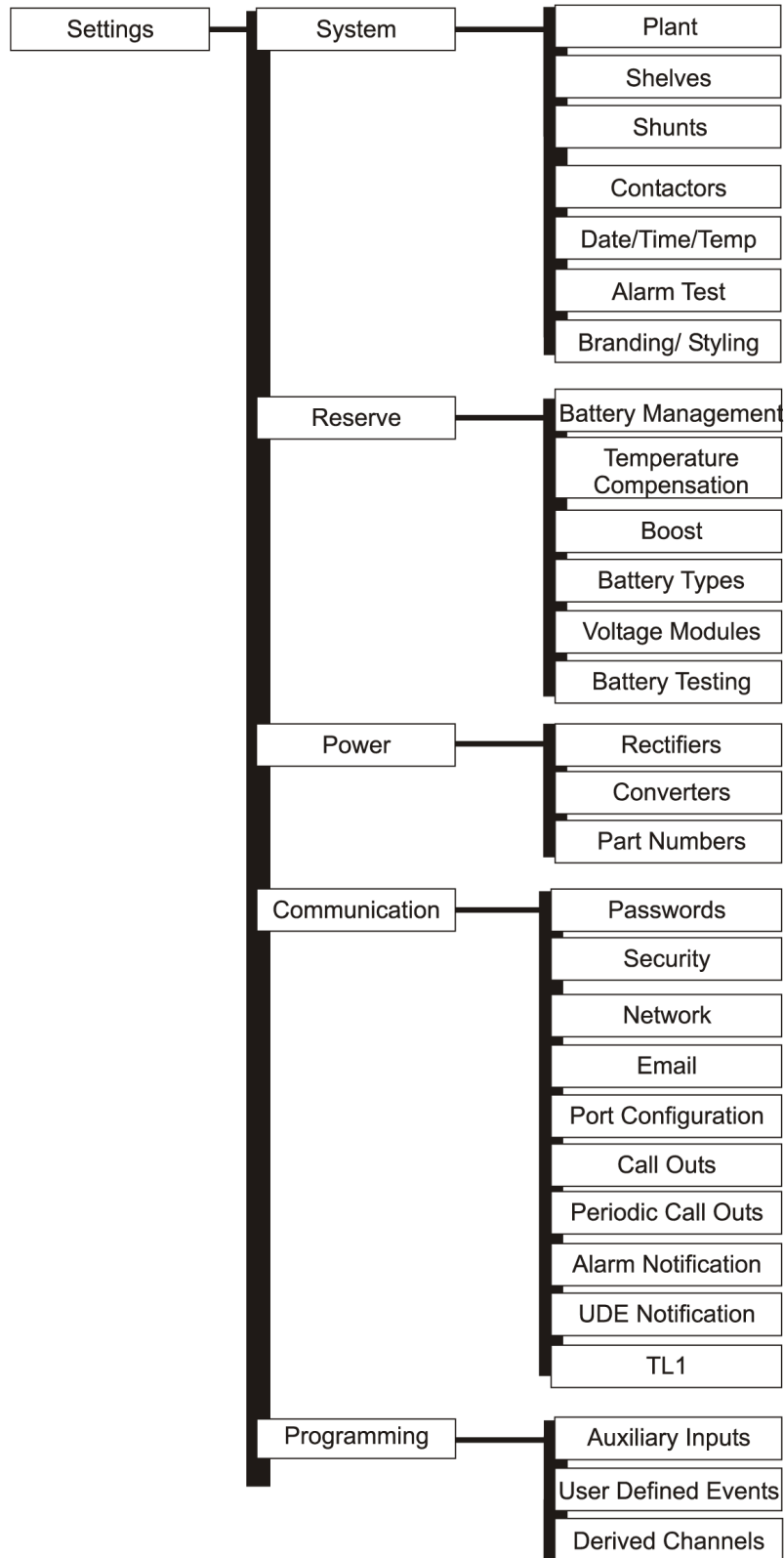

Figure 15 Settings Menu

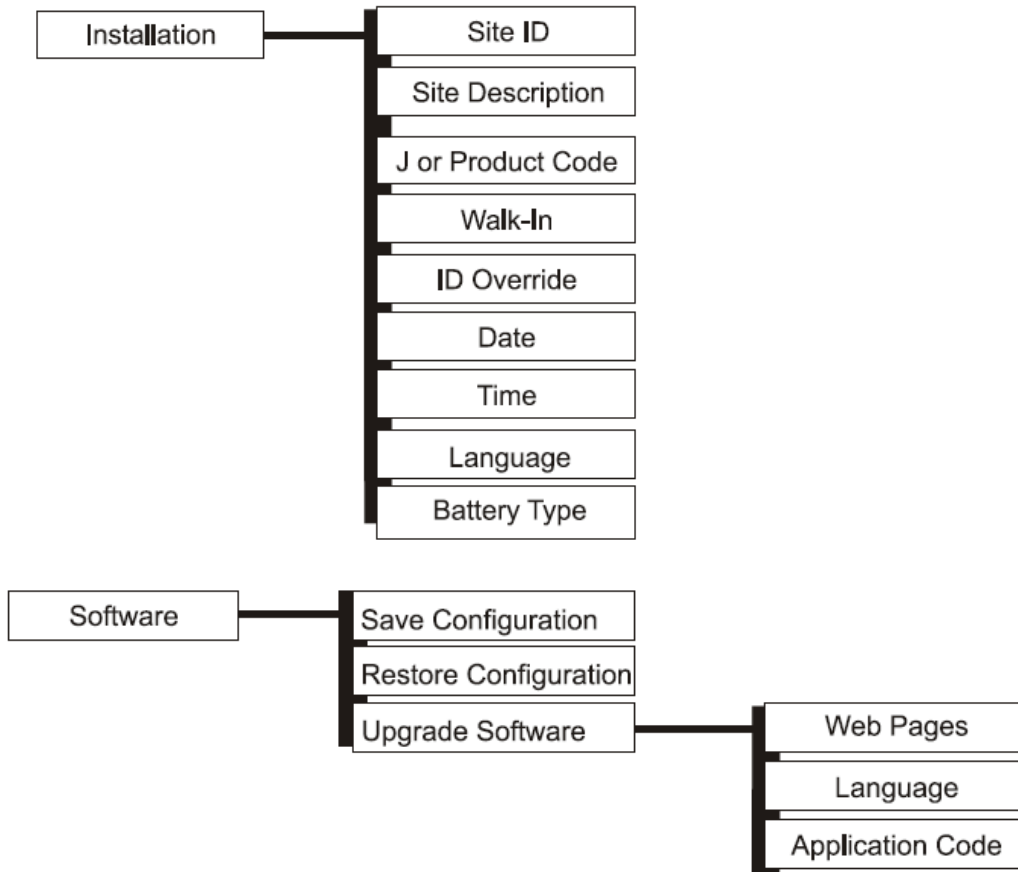
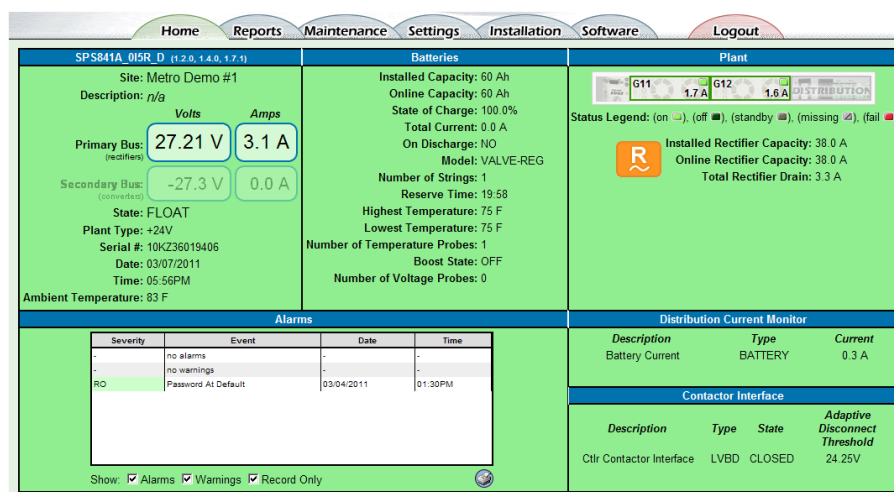
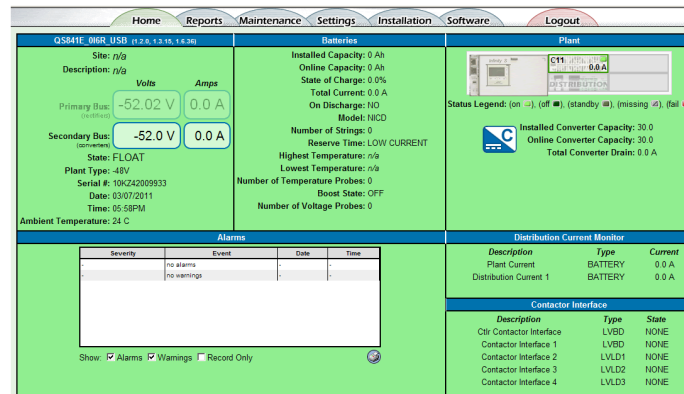

Figure 16 Installation and Software Menu

Home Tab

The Home page provides an overview of the status of system components. Below are sample home screen shots from a Slim Line Power System (SPS) and an Infinity-C 663 converter shelf. The graphical representation of the plant changes as well as a few other parameters specifically concerning rectifiers and converters, respectively. This page is meant to provide an overall high level view of the system. Configuration is not possible from the Home or main menu.





Plant

The “Plant” section of the Home page shows various characteristics of the power modules in the system. A graphical representation of the rectifiers in the system or shelf is included as well as a visual indication of each individual rectifier’s status including the output current from each of the rectifiers or converters. Systems that ship with the controller installed generally have the plant configuration

pre-configured from the factory. This display configuration can be modified as needed under the Settings → System → Plant and Installation → J or Product Code. In addition the following items are provided:

Installed Rectifier/Converter Capacity	Provides the total installed rectifier/Converter capacity in the system. The rectifiers/converters that are inserted into the shelf may or may not have AC or DC input power applied, respectively, or be outputting power but are able to communicate to the controller through back- bias power.
On-line Rectifier/Converter Capacity	The total capacity of the number of rectifiers/converters installed in the system and able to produce power, respectively. Rectifiers or converters that are operating or in Standby are considered to be On- line. Rectifiers that are in RFA, ACF, etc. or converters in CFA or DC input failure are not counted in the On-line capacity
Total Rectifier/Converter Drain	The total rectifier/converter drain is the summation of output currents from all rectifiers or converters, respectively. This value is also displayed on the default front panel screen.
Rectifier/ ConverterMonitoring	Each rectifier’s DC output current, AC input current (If supported), and AC input voltage (If supported) is available by rectifier number, Gmn. Converters provide their DC output current using converter number Cmn. In both cases, “m” represents the shelf number and “n” represents the slot number in the shelf. In addition to the ON state, other states identified when current is not shown are: <ul style="list-style-type: none"> • OFF: Rectifier/Converter shutdown due to hardware failure. • STANDBY: The rectifier’s/converter’s output voltage has been inhibited. • MISSING: An unacknowledged rectifier/converter has been removed. • VACANT: Rectifier/converter has not been installed in that position. • FAIL: The rectifier/converter has failed.

Note: Right clicking on the graphic of the rectifier or converter will pull up a pop-up window that provides additional details on each of the rectifiers/converters, respectively. A sample screen shot for each is shown on next page

Plant(Continued)

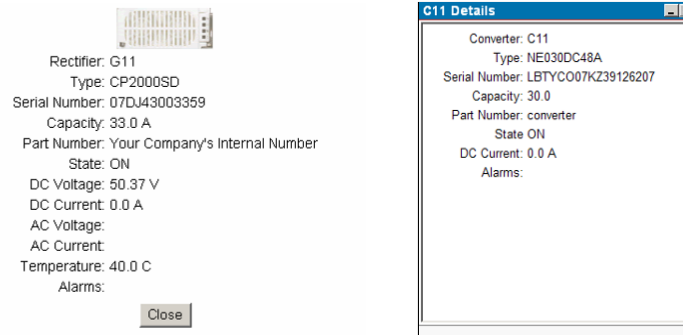

Batteries

The battery section of the page shows various status characteristics of the battery reserve system configured for the system. The following items are provided:

Installed Capacity	Total installed battery capacity based upon the number of strings in the system and the Amp-Hour (AH) rating of the strings installed. This data is automatically calculated. Specific battery models included in the standard or custom controller configurations have default AH values. AH rates are 8-hour rates. These values can be modified in the field as needed. Values are used for battery capacity calculations
Online Capacity	Capacity sum of all batteries installed in the system and are able to provide power in the event of an AC failure. Batteries taking removed from the system using a contactor are considered not to be online.
State Of Charge	The relative state of charge in % of rated battery capacity approximation of the battery string. Calculation is based upon coulomb counting techniques.
Total Current	Measured value of the current flowing into or out of all system battery shunts.
On Discharge	The direction of current flow in and out of the batteries. "Yes" when being discharged and "No" in normal state.
Model	The specific battery model or Generic class of battery configured to be installed in the system.
Number Of Strings	The total number of battery strings installed in the system. This value needs to be configured unless provided in custom default configuration.
Reserve Time	Provides the controller calculated reserve time for the batteries installed in the system based upon discharge data or coulomb counting techniques (hh:mm). Note: may also display "LOW CURRENT" or "HIGH CURRENT" if the values of current are not consistent with the system capacity.
Highest Temperature	Highest battery temperature being measured by the QS871 thermal probes attached in the system.
Lowest Temperature	Lowest battery temperature being measured by the QS871 thermal probes attached in the system.
Num Temp Probes	Total number of installed QS871 thermal probes. Up to sixteen QS871 battery probes can be managed by the controller.
Boost State	Provides indication that the system is in the Boost state of operation. Possible modes are OFF, QRCT (Current terminated), MANUAL, and TIMED AUTO.
Num Mid-String V	Total number of installed ES771 Mid-String voltage measurement modules. Up to six ES771 modules can be monitored.

Note: When the ES771 mid-string voltage monitors are present and actively measuring battery strings the independent voltage values will be provided in the battery section. Up to three mid-string voltage readings per module is obtainable.

Alarms

All active alarms, warnings, and record only events are shown at the lower corner of the web “Home” page. The severity, description, date, and time of each event is provided. Alarms with Major and Minor severity are shown by default. By clicking on the “Warnings” and “Record Only” enable boxes events assigned to these categories will also show up. Items are listed with the most recent occurrence events and then by severity.

Alarms			
Severity	Event	Date	Time
MAJ	Very Low Voltage	11/15/2007	08:27 AM
MIN	Battery On Discharge	11/15/2007	08:27 AM
-	no warnings	-	-
RO	Password At Default	11/14/2007	01:34PM
RO	Configuration Changed	11/14/2007	01:34PM

Show: Alarms Warnings Record Only

A printer logo is provided to allow a quick link to the user for printing out this alarm list in a friendly format

Distribution

The Pulsar Edge has the ability to manage up to eight Low Voltage Disconnects assigned to four separate Low Voltage Disconnect (LVD) threshold sets. These LVDs can be assigned to Low Voltage Battery, Low Voltage Load 1, Low Voltage Load 2, and Low Voltage Load 3 thresholds. The Home page provides the contactor type and state and the distribution type and currents for the various monitored components.

Distribution Current Monitor		
Description	Type	Current
Battery Current	BATTERY	0.0 A

Contactor Interface		
Description	Type	State
Ctrl Contactor Interface	LVBD	OPEN

LVBD	Provides LVBD (Low Voltage Battery Disconnect) status. “None” is displayed for each non-configured contactor. “Closed” is shown for normal contactor state. “Open” shown for contactors that have opened and disconnected the battery. The summation of all shunts monitored by distribution monitoring boards ID1-ID8 that are assigned to battery or load current is shown. Configuring the centralized plant shunt as a battery shunt will also be the value shown here.
LVL(1-3)	Provides the status of the three LVLs (Low Voltage Load Disconnects 1-3). “None” is displayed for each non-configured contactor. “Closed” is shown for normal contactor state. “Open” will be shown for contactors that have opened or disconnected each respective load. The summation of all shunts monitored by distribution monitoring boards ID1-ID8 that are assigned to each specific LVL is summed and shown for its respective assignment.

Pulsar Edge/System

This section provides the high level view of the power system states which includes the items shown below.

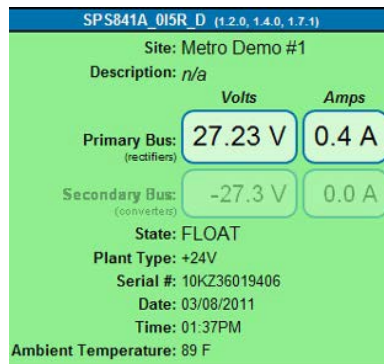

Site	Displays up to 20 configured characters entered for the Site identification.
Description	Displays up to 55 characters entered for the Site Description.
Primary Bus	Displays the values of the system rectifier DC output bus voltage and output current (value to the load). The bus voltage is measured directly by the Pulsar Edge. The load current displayed depends on the system configuration and is either a calculated value, a value determined by remote monitoring modules, or measured directly by the shunt monitor on-board the Pulsar Edge. Note: the shunt must be mounted in the grounded side of the system's DC bus. Possible damage may occur if the shunt is connected incorrectly.
Secondary Bus	Displays the values of the system converter DC output bus voltage and output current (value to the load). The bus voltage is measured directly by the Pulsar Edge. The load current displayed depends on the system configuration and is obtained by summing
State	Provides the present operating mode of the system. (Float, Boost)
Plant Type	Indicates the generic voltage classification of the power system: -48V, +24V, +48V, etc.
Serial Number	The serial number of the installed Pulsar Edge Controller.
Date	Present Date of the Pulsar Edge on-board real-time clock using the configured Date format.
Time	Present time of the Pulsar Edge on-board real-time clock using the configured time format.
Ambient Temperature	Value of temperature sensor embedded in the controller display. Meant to provide a relative temperature.

SPS841A_015R_D (1.2.0, 1.4.0, 1.7.1)

At the top of this section are the controller name and code versions . Placing the cursor over the numbers in the () will provide the software version of the boot block, application code, and web pages.

Reports Tab

The Reports page provides Inventory, Battery Discharge History, Statistics, Trends, Alarm History, Boost History, Login History, Rectifier History, and Converter History in report format. Data is stored on a first in first out event storage scheme. Once the record size of a specific field is reached the data first in will be discarded for the newer data. These screens are generally self-explanatory. Following are sample screens from these tabs.

Inventory

Inventory											
Plant			Controller			Battery					
Site ID: Mesquite, TX Description: SIT Lab Plant Type: -48V Volts: -54.10 V Amps: 0.0 A			Board Code: CP841A Serial Number: 07D143000041 Boot Block: 1.2.0 Application: 0.0.6 Web Pages: 0.2.4 Defaults: NT1-0.3			Battery: 1 string of VALVE-REG Capacity: 50 Ah installed, 50 Ah online Monitoring: 6 thermal, 0 voltage Reserve Time: LOW CURRENT Test Results: NOT RUN... String 1 Midpoint: AVAILABLE String 2 Midpoint: AVAILABLE String 3 Midpoint: AVAILABLE String 4 Midpoint: AVAILABLE String 5 Midpoint: AVAILABLE String 6 Midpoint: AVAILABLE					
No converter data											
Rectifier	Type	Serial Number	Capacity	Part Number	State	DC Voltage	DC Current	AC Voltage	AC Current	Temperature	Alarms
G11	CP2000SD	07D1430003959	33.0 A	Your Company's Internal Number	ON	54.11 V	0.0 A			40.0 C	
G12	CP2000SD	07D1430003952	33.0 A	Your Company's Internal Number	ON	54.12 V	0.0 A			40.0 C	
G13	CP2000SD	07D1430003960	33.0 A	Your Company's Internal Number	ON	54.09 V	0.0 A			40.0 C	

Battery Discharge

Provides a chronological view of up to the last 16 battery on discharge (BD) alarm events that have occurred since the last time the history log was cleared. In addition, 300 points are used to store battery discharge profiles. A typical discharge curve for a standard constant power load utilizes about 30 points a curve. Selecting Battery Discharge from the reports screen produces the following page.

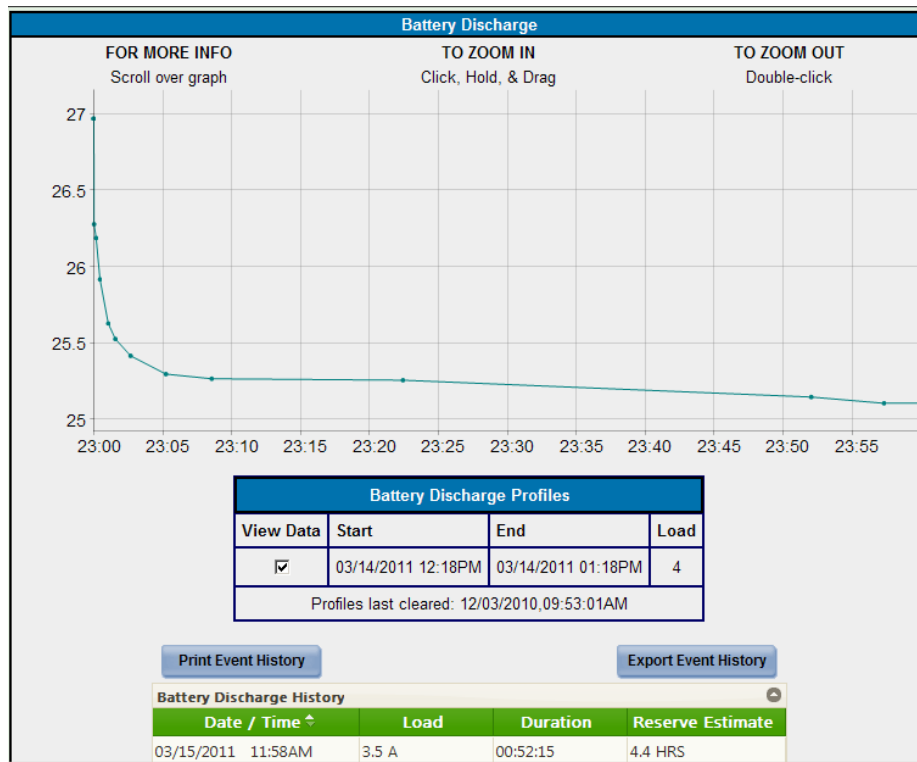

The Battery Discharge History events provide date and time, average load during discharge, and duration of each recorded battery discharge event. The reserve time will be provided if available for each event. Selecting a color from the view data screen will allow the discharge curve profiles to be graphed and overlaid.

Statistics

Basic statistics are stored for the plant load, battery temperature, and controller ambient temperature. Selecting Statistics from the reports screen produces a screen like the following:

Statistics		
Plant Load	Battery Temperature	Ambient Temperature
Started 12/03/2010 09:53AM	Started 12/03/2010 09:53AM	Started 12/03/2010 09:53AM
<i>Highest Hourly</i>	<i>Highest Hourly</i>	<i>Highest Hourly</i>
03/03/2011 11:09AM 13 A	02/26/2011 05:00PM 82.4 F	01/16/2011 02:59PM 166.1 F
02/25/2011 10:52AM 17 A	02/26/2011 04:11PM 82.4 F	01/14/2011 05:17PM 166.1 F
02/25/2011 11:06AM 18 A	02/23/2011 07:44AM 87.8 F	01/08/2011 07:11AM 166.1 F
<i>Lowest Hourly</i>	<i>Lowest Hourly</i>	<i>Lowest Hourly</i>
12/03/2010 03:53PM 0 A	02/22/2011 04:59PM 71.6 F	12/21/2010 03:47PM 65.3 F
12/03/2010 04:00PM 0 A	02/23/2011 05:01PM 71.6 F	01/03/2011 05:31PM 67.1 F
12/03/2010 05:00PM 0 A	02/28/2011 09:14PM 71.6 F	02/16/2011 09:04AM 68.9 F
<i>Highest Average (Hourly)</i>	<i>Highest Average (Hourly)</i>	<i>Highest Average (Hourly)</i>
02/19/2011 09:00AM 7 A	02/26/2011 07:00PM 82.4 F	01/17/2011 01:00PM 94.8 F
02/19/2011 10:00AM 7 A	02/26/2011 06:00PM 82.4 F	01/17/2011 12:00PM 94.9 F
02/25/2011 11:00AM 9 A	02/26/2011 05:00PM 82.4 F	12/03/2010 03:00PM 96.8 F

Highest Hourly	At the change of each hour, the highest instantaneous value for the previous hour is compared with the three highest hourly Minimum stored memory. If it is greater than any of those, the lowest maximum value will be deleted and the new value included in the three highest maximum values.
Lowest Hourly	At the change of each hour, the lowest instantaneous value for the previous hour is compared with the three lowest hourly minimum values stored in memory. If it is smaller than any of those, the highest will be deleted and the new value included.
Highest Average (Hourly)	The three highest hourly averages are kept in memory and updated each hour. Collection of data begins when the first valid hourly average is available.

Trends

Trend statistics are stored for the plant load. Selecting Trends from the reports screen produces the following page

Trend for Primary Bus (reactor)
DES
Cleared 11/12/2007 12:55PM
<i>Highest Daily</i>
11/12/2007 03:43PM 0 A
11/13/2007 02:41PM 0 A
11/14/2007 01:34PM 0 A
11/15/2007 12:00AM 0 A
11/16/2007 04:12PM 0 A
11/17/2007 12:00AM 0 A
11/18/2007 12:00AM 0 A
<i>Lowest Daily</i>
11/12/2007 12:55PM 0 A
11/13/2007 02:41PM 0 A
11/14/2007 01:34PM 0 A
11/15/2007 12:00AM 0 A
11/16/2007 04:12PM 0 A
11/17/2007 12:00AM 0 A
11/18/2007 12:00AM 0 A
<i>Highest Average (Daily)</i>
11/12/2007 11:00PM 0 A
11/13/2007 02:00PM 0 A
11/14/2007 01:00PM 0 A
11/15/2007 12:00AM 0 A
11/16/2007 04:00PM 0 A
11/17/2007 12:00AM 0 A
11/18/2007 12:00AM 0 A
<i>Highest Average (Monthly)</i>

Trends(continued)

Highest Daily	The instantaneous highest value readings, for each of the previous 16 days.
Lowest Daily	The instantaneous lowest value readings, for each of the previous 16 days.
Highest Average(Daily)	The highest one-hour average values, for each of the previous 32days.
Highest Average(Monthly)	The monthly average of the daily maximum one-hour averages, for each of the previous 13 months.

Alarm History

Provides a chronological view of up to the last 1000 alarm events that have occurred since the last time the history log was cleared. Selecting Alarm History from the reports screen produces the following page. Event times can be zoomed in by using the cursor and clicking on a particular month, day, or hour. Clicking on “before” or “after” will pull up the alarms for respective times before or after those presently being displayed. Click on the column headers in the Event history table to display the events in an ascending or descending order. There are also quick links to allow printing and exporting of the event data.

Events	Before	2011 (months)												After			
		Jan	Feb	Mar	Apr	May	Jun	Jul	Aug	Sep	Oct	Nov	Dec				
Battery Test Active	0																0
Open String	0																0
Battery On Discharge	0																0
Imminent Low V Shutdown	0																0
LVBD 1 Open	0																0
Very Low Voltage	0																0
High Ambient Temperature	0																0
Processor Halt	0																0
Password At Default	0																1
Minor Communication Fail Alarm	0																0
External Fuse Major	0																0
Rectifier Current Limit	0																0
AC Fail	0																0
Multiple AC Fail	0																0
Configuration Changed	0																0

#	Description	Date / Time	Alarm
1	Battery Test Active	03/02/2011 08:44AM	Record Only
2	Battery Test Active	03/02/2011 09:40AM	Retired
3	Open String	03/02/2011 11:17AM	Major
4	Battery On Discharge	03/02/2011 11:22AM	Warning

Boost History

Provides a chronological view of up to the last 16 times the system entered boost mode since the last time the history log was cleared. Selecting Boost History from the reports screen produces the following page.

Date	Time	Start Reason	Stop Reason	Duration
03/04/2011	02:59PM	CURRENT	CURRENT	1.4 HRS
03/03/2011	09:07AM	CURRENT	CURRENT	1.2 HRS
03/02/2011	12:42PM	CURRENT	CURRENT	0.0 HRS
03/02/2011	09:40AM	CURRENT	CURRENT	1.3 HRS
03/01/2011	05:18AM	CURRENT	CURRENT	2.1 HRS

Login History

Login History provides a chronological view of the various login-in accesses experienced by the controller. These can be access through the local port, modem, or network. The level of access as well as the application (over a network connection) is listed. Selecting Login History from the reports screen produces the following page.

Login History				
Date	Time	Port	Application	Action
03/08/2011	02:29PM	Network	TERMINAL	SUPER-USER
03/08/2011	02:19PM	Network	WEB	ADMINISTRATOR
03/08/2011	02:08PM	Network	WEB	SUPER-USER
03/08/2011	01:19PM	Network	WEB	ADMINISTRATOR
03/08/2011	09:32AM	Network	WEB	SUPER-USER
03/08/2011	09:28AM	Network	WEB	ADMINISTRATOR
03/07/2011	06:46PM	Network	WEB	ADMINISTRATOR
03/07/2011	05:55PM	Network	WEB	SUPER-USER
03/07/2011	05:52PM	Network	WEB	ADMINISTRATOR
03/04/2011	05:09PM	Network	TERMINAL	LOGOUT
03/04/2011	03:00PM	Network	TERMINAL	LOGOUT
03/04/2011	02:59PM	Network	TERMINAL	ADMINISTRATOR
03/04/2011	02:52PM	Network	FTP	LOGOUT
03/04/2011	02:48PM	Network	FTP	ADMINISTRATOR
03/04/2011	02:41PM	Network	TERMINAL	LOGOUT
03/04/2011	02:01PM	Network	TERMINAL	ADMINISTRATOR
03/04/2011	02:01PM	Network	TERMINAL	ADMINISTRATOR
03/04/2011	01:38PM	Network	WEB	SUPER-USER
03/04/2011	01:34PM	Network	WEB	ADMINISTRATOR
03/04/2011	10:25AM	Network	FTP	LOGOUT

Login History	Chronological view of the last local terminal logins, Modem logins, and network accesses that have occurred since the last time the history log was cleared. The number of these events counts towards the total number of Modem, Network, and Local portevents which can be up to 48 events.
Date/Time	The date and time that a user connected or disconnected from the controller.
Application	Provides application connection type used over the network (Terminal, Web, FTP)
Action	Level of login (user, super-user, administrator) or logout function.
Port	Provides user access type: Local Port, Modem Port, Network

Rectifier History

Provides a chronological view of up to the last 256 rectifier alarms and events that have occurred since the last time the history log was cleared. Selecting Rectifier History from the reports screen produces the following page:

Rectifier History			
Rectifier	Date	Time	State Change
G12	03/08/2011	02:17PM	ON
G11	03/08/2011	02:17PM	ON
G12	03/08/2011	02:17PM	MISSING
G11	03/08/2011	02:17PM	MISSING
G12	03/04/2011	01:30PM	ON
G11	03/04/2011	01:30PM	ON
G12	03/04/2011	01:30PM	MISSING
G11	03/04/2011	01:30PM	MISSING
G12	03/04/2011	01:21PM	OFF(ACF)
G11	03/04/2011	01:21PM	OFF(ACF)
G12	03/04/2011	12:36PM	ON
G11	03/04/2011	12:36PM	ON
G12	03/04/2011	12:36PM	MISSING
G11	03/04/2011	12:36PM	MISSING
G11	03/04/2011	11:02AM	ON
G12	03/04/2011	11:02AM	ON
G12	03/04/2011	11:02AM	MISSING

Converter History

Provides a chronological view of up to the last 256 converter alarms and events that have occurred since the last time the history log was cleared. Selecting Converter History from the reports screen produces the following page:

Converter History			
Rectifier	Date	Time	State Change
C12	03/08/2011	02:58PM	ON
C11	03/04/2011	09:57AM	ON
C12	03/04/2011	09:57AM	MISSING
C11	03/04/2011	09:57AM	MISSING
C12	03/03/2011	04:10PM	MISSING
C11	03/03/2011	04:10PM	ON
C12	03/03/2011	03:57PM	MISSING
C11	03/03/2011	03:57PM	ON
C12	03/03/2011	03:55PM	MISSING
C11	03/03/2011	03:55PM	ON
C11	03/03/2011	03:55PM	ON
C12	03/03/2011	03:55PM	MISSING

Maintenance Tab

The following are the system control and operation functions that can be performed from the Maintenance page. These controls and operations are categorized as System, Data, Disconnects, and Rectifier operations. These operations are generally used in post installation and maintenance operations.

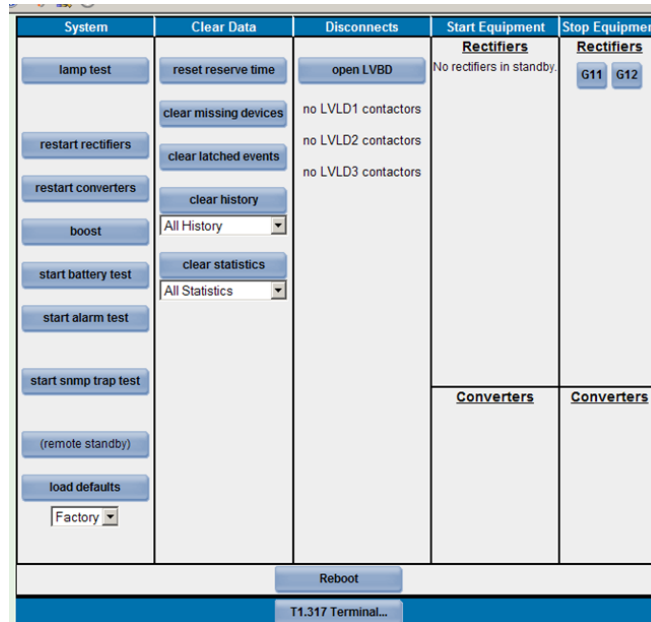

System Maintenance Operations

Lamp Test	Temporarily illuminates all status indicators of attached rectifiers,distribution monitoring and control modules and the system controller.
Restart Rectifiers	Provides the ability to restart all system serial controlled rectifiers a tonce. This operation does not affect rectifiers and other system devices that are already functioning.
Restart Converters	Provides the ability to restart all system serial controlled converters at once. This operation does not affect converters and other system devices that are already functioning.
Boost	Initiates the manual battery Boost feature. A stop battery Boost operation is displayed to interrupt the Boost operation mode and return the unit to normal operation.
Start Battery Test	Initiates the manual battery test feature. A stop battery test operation is displayed to interrupt the testing and return the unit tonormal operation. The manual battery test utilizes the configured test duration and a system bus voltage threshold to represent the end of reserve.
Start Alarm Test	Provides ability to initiate an alarm test on a specific user selected output relay or all output relays. Alarm relays are asserted at the configured alarm interval.
Start SNMP TrapTest	Provides ability to generate the configured SNMP traps all at onceswithout having to actually generate the specific system alarm condition. All assigned traps are sent out at once.
Remote Standby	Allows a remote user to place a designated group of rectifiers all into Stand by when the Remote Group Standby feature is enabled
Load Defaults	This operation allows a user to bring back all factory default settings and configurations with a single operation. Factory defaults are also custom configuration defaults when they are available. Custom configurations may support multiple factory defaults. Caution must be used when applying this command. Previous configuration changes made in the field will be overwritten with the factory values.

Clear Data Maintenance Operations

Reset Reserve Time	Resets any reserve time calculations or prediction data to allow the system a new starting point.
Clear Missing devices	Clears alarms related to the removal of a system component such as a rectifier, thermal probe, or voltage monitoring module. Running this command allows the system controller to retake inventory of using equipment over the various digital communication busses.
Clear Latched Events	Used to clear momentary events or alarms that are latched by the Pulsar Edge. It clears the following system alarms: Check Battery, Reserve Time Low, Real-Time Reserve Low, Battery Voltage Imbalance, External Password Reset, Excessive Login Attempts, Clock Changed, Self Test Failed, Configuration Changed, History Cleared, Incompatible Rectifier, Incompatible Converter, Queue Overflow, No Call-Out Response, No Dial-Out Response, Alarm Test Aborted, Redundancy Loss Alarm, and Converter Redundancy Loss.
Clear History	<p>This operation is used to clear the various items that the controller maintains history records. Once cleared the controller begins to keep history of new events.</p> <p>All History Single command to clear all history.</p> <p>Alarm History Clears only alarm event history.</p> <p>BD History Clears only BD history.</p> <p>Rectifier History Clears only rectifier event history.</p> <p>Boost History Clears only Boost event history.</p> <p>Local Port History Clears only local port access event history.</p> <p>Modem History Clears only Modem port access event history.</p> <p>Network History Clears only network access history.</p>
Clear Statistics	<p>This operation is used to clear the various items that the controller maintains statistical records. Once cleared the controller begins to keep new statistics.</p> <p>All Statistics Single command to clear all statistics.</p> <p>Plant Load Clears only plant load statistics.</p> <p>Battery Discharge Clears the Battery on Discharge (BD) statistics kept on the plant load and voltage during discharge.</p> <p>Battery Temp Clears only battery temperature statistics.</p> <p>Trend Clears only Trend statistics kept on the load.</p>

Disconnects Maintenance Operations

Appropriate Buttons are provided to allow operation of LVDs when they are attached in the system.

Open/Close LVBD	Provides individual manual control of Low Voltage Battery Disconnect (LVBD) for maintenance purposes.
Open/Close LVLD1	Provides individual manual control of Low Voltage Load Disconnect 1 (LVLD1) for maintenance purposes.
Open/Close LVLD2	Provides individual manual control of Low Voltage Load Disconnect2 (LVLD2) for maintenance purposes.
Open/Close LVLD3	Provides individual manual control of Low Voltage Load Disconnect 3 (LVLD3) for maintenance purposes.

Rectifier or Converter Start/Stop Maintenance Operations

The maintenance page in the Pulsar Edge provides a remote user the ability to place a rectifier into Standby if the “Remote Rectifier In Standby”. A user has the ability to turn-off (Stop) or turn-on (Start) a specific rectifier. These are based upon the position of the buttons. G11 below has been placed into Standby and can be turned back on or started by initiating the Start Rectifier for G11. Rectifiers G12 and G13 are On and producing power. These rectifiers can be manually placed into Standby (Off) by performing the Stop operation.

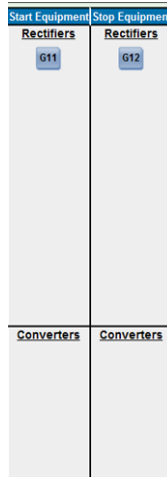

T1.317 Terminal

The maintenance page provides the user the ability to open a T1.317 command line session over the network. Clicking the button located at bottom of the page opens up a command-line session that allows a user to enter and execute specific T1.317 commands.

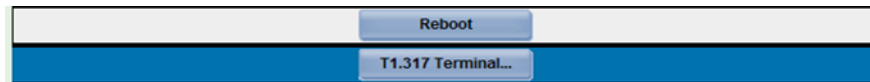

Enter the specific T1.317 command at the allocated space and press the execute button. The controller will send its response in the area shown. Clicking on Bye/Close will close out the window and return the maintenance window.

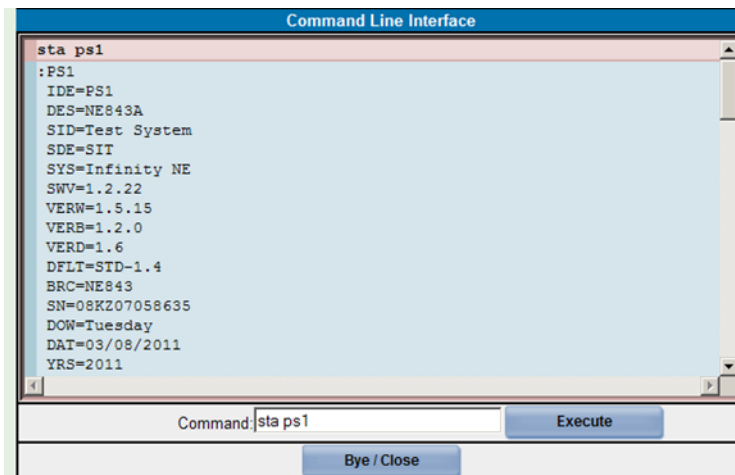

In addition to the maintenance page T1.317 button, a user can click on the Command Line Interface, CLI, button shown below which is located on every page for quick access.

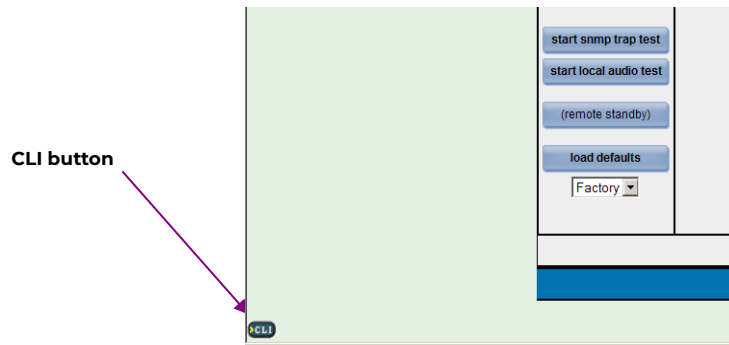

Reboot

The maintenance page provides a Reboot button that issues a T1.317 command line reboot command over the network. The controller will reboot upon receiving this command and connectivity will have to be reestablished.

Settings Tab - Configuration

The Settings page is where system operational parameters, system device information, and alarm thresholds are set-up and modified. Configurable parameters are sectioned under five main headings: System, Reserve, Power, Communication, and Programming. Factory defaults are provided for the various configurable items in the standard Pulsar Edge controller. Some defaults are dependent on the battery type. Consult Appendix E for default settings of different battery. Valve-Regulated Lead Acid (VRLA) batteries and default settings defined for the Standard configuration are assumed in this section. Customer specific configurations may be different. When there is doubt, contact OmniOn technical support.

All items are field configurable. Modified settings are stored in non-volatile memory. The Pulsar Edge requires time to update sectors in flash memory for changes. Allow approximately a minute for the Pulsar Edge to accept and store modifications in non-volatile memory before removing power to the unit.

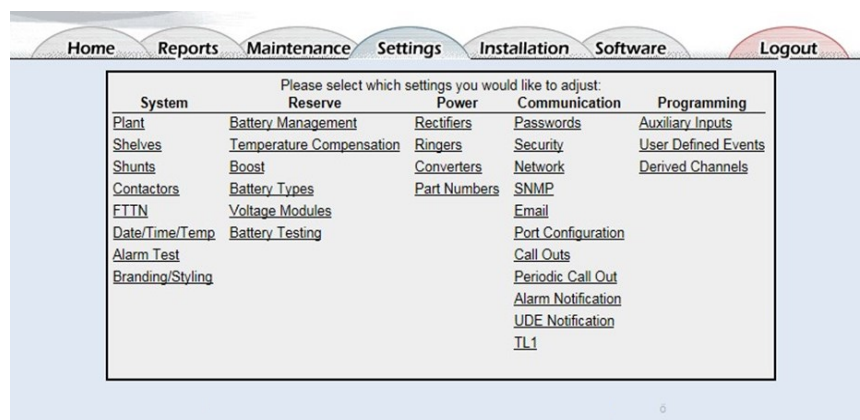

Plant

Items in the section shown below are thought of plant level configurations. The ability to assign the different alarm events severities, relays (if present), and to the LED is provided. Alarm events can be assigned Critical (CRIT), Major (MAJ), Minor (MIN), Warning (WRN), or Record Only (RO) severities. Submit must be used to save the changes.

Alarm	Severity	Relay	LED	Threshold
High Ambient Temperature	MIN			35 C
Low Ambient Temperature	MIN			0 C
Auxiliary	MAJ			
Emergency Power Off	MAJ			
Major Fuse	MAJ			
Minor Fuse	MIN			
Sense Voltage Fail	MIN			
Imminent Shutdown	MAJ			
Configuration Changed	RO			
ID Conflict	MAJ			
Excessive Login Attempts	WRN			
History Cleared	RO			
Password At Default	RO			
Processor Halt	RO			
Self Test Failed	MIN			
ID Not Configured	MAJ			
Minor Communication Fail	MIN			
Major Communication Fail	MAJ			

Site ID	Up to 20 configured characters can be entered for the Site Identification.
Site Description	Up to 55 characters can be entered here for the Site Description.
Enable Imminent LVBD Shutdown	When enabled, the Imminent Shutdown Alarm is generated prior to opening the LVBD. Once the LVBD threshold has been reached, the alarm is generated. The alarm is issued 15 seconds prior to opening the contactor to provide an indication that system shutdown is imminent due to a system battery disconnect. The alarm is based on the configured LVBD battery disconnect threshold. The factory default for this feature is Disabled.
Critical Equals Major	Asserts the Critical alarm severity with all Major alarms.

Shelves

Items in the section shown below are used to define the physical attributes of the system or plant. This includes the number of bays/frames, number of shelves per bay/frame, whether the bay/frame has a door and if the controller is located on the door, and the shelf width. It also provides the ability reserve positions in the shelf for specific components like distribution so that the system can be depicted on the Home page. Adding a frame/bay would split the plant section on the Home page to show the number of frame/bays graphically, respectively. Note: The J or Product code selections found in the Installation section provide pre-configured configurations for the items in the list.

Bay and Shelf Layout

BAY: 1 Shelves: 1

 Slots: 3

In Shelf Controller: [dropdown]

19" Frame Size [dropdown]

R R D

Bottom Up

Add Frame/Bay

Clear Saved Layout

Save Layout

Shunt

Items here define the different shunts being monitored by the controller. One shunt, the Plant Shunt, is monitored directly by the Pulsar Edge. Up to eight shunts can be monitored through various remote distribution monitoring and control boards. The Pulsar Edge utilizes an RS485 serial communication link to external distribution monitoring and control boards for shunt measurements and contactor control. Up to eight of these external boards can be managed by the controller. Up to eight contactors can be assigned to one of four independent control groups: LVBD, LVLD1, LVLD2, and LVLD3. External distribution monitoring and control boards are identified by an address ID on the board. Assignments are then made to appropriate operation types at the controller. The available Types are: Battery, Load, and None. Shunt sizes for each assigned battery or load type must also be configured. All monitored shunts are assumed to have a 50mV voltage rating. The current rating of each shunt is programmable between 0 to 9999A. Systems shipped with the Pulsar Edge are appropriately pre-configured in the factory for the right shunt values and assignments. The descriptions for the shunt measurements can also be edited for additional resolution.

Shunts						
All Loads Monitored by Remote Shunts <input type="checkbox"/>						
Plant Shunt	Description	State	Type	Rating (amps)	Voltage (mV)	Reading
	Battery Current	PRESENT	BATTERY	50 A	50 mV	0.0 A
Shunt	Description	State	Type	Rating (amps)	Reading	
1	Distribution Current 1	NONE	NONE	300 A	0.0 A	
2	Distribution Current 2	NONE	NONE	600 A	0.0 A	
3	Distribution Current 3	NONE	NONE	600 A	0.0 A	
4	Distribution Current 4	NONE	NONE	600 A	0.0 A	
5	Distribution Current 5	NONE	NONE	600 A	0.0 A	
6	Distribution Current 6	NONE	NONE	600 A	0.0 A	
7	Distribution Current 7	NONE	NONE	600 A	0.0 A	
8	Distribution Current 8	NONE	NONE	600 A	0.0 A	

Submit

Plant Shunt Type	<p>Definition type for the on-board shunt used for centralized plant architectures that are designed with a single shunt to monitor load or battery current. The on-board shunt monitor may be configured as "NONE", "BATTERY", or "LOAD".</p> <p>The factory default is Battery.</p> <p>Note: the shunt must be mounted in the grounded side of the system's DC bus. Possible damage may occur if the shunt is connected incorrectly.</p>
Plant Shunt Rating	<p>Current rating of the shunt being measured by the on-board shunt circuitry used for centralized plant architectures. Shunts are assumed to have a 50mV rating.</p> <p>The rating can be set from 0A to 9999A with a factory default setting of 150A. Values are adjusted to rating of shelf when controller is shipped installed in a shelf.</p>
ID1-8	<p>The operation Type of each shunt monitoring circuit on system distribution boards 1-8 must be assigned based upon actual system implementation. The controller will display the individual values of the shunts as well as sum "like" to provide a total.</p> <p>The operational Type may be: None (For no shunt), Battery (Monitoring battery currents), and Load (for load currents).</p>
ID1-8 Rating	<p>The current rating of each shunt being monitored by the system distribution boards 1-6 must be configured based upon actual system implementation. All shunts are assumed to be 50mV. The current rating may be from 0-9999 Amps.</p> <p>The factory default is 600A for load shunts and 800A for the battery.</p>
All Loads Monitored	<p>When Enabled, the All Load Monitor feature automatically links all Shunt Monitors configured as "Load" monitors to the system total load. This feature is operational only when the Plant Shunt Type is configured as NONE.</p> <p>The factory default is Disabled.</p>

Defaults

The Pulsar Edge is factory configured with:

ID1	Type: None	Shunt: 150A
ID2	Type: None	Shunt: 300A
ID3	Type: None	Shunt: 600A
ID4	Type: None	Shunt: 600A
ID5	Type: None	Shunt: 600A
ID6	Type: None	Shunt: 600A
ID7	Type: None	Shunt: 600A
ID8	Type: None	Shunt: 600A

IDs defined as **None** will have no currents displayed and shunt configuration has no affect.

Note: Depending on the system and controller configuration for that system the values of the total load current (load) are calculated differently.

Table 3 Current Calculations

Shunt Type	System Configuration	Controller Operation
Battery	<p>Shunt input is connected to a centralized battery shunt located in the system. All battery current flows through this shunt to and from the system batteries. System may or may not have Shunt Monitors configured.</p> <p>Note: the shunt must be mounted in the grounded side of the system's DC bus. Possible damage may occur if the shunt is connected incorrectly.</p>	<p>Controller reports the following:</p> $I_{Load} = \sum I_{Rect} + I_{plantshunt}$ $I_{battery} = I_{plantshunt}$ <p>Where $I_{plantshunt}$ is negative for current into the battery and positive for current out of the battery.</p> <p>If there are shunt monitor cards also installed:</p> <ol style="list-style-type: none"> 1. Cards configured as monitoring a "Load" shunt shall not affect the total I_{Load} but have their values individually displayed. 2. Cards configured as monitoring a "Battery" shunt shall not contribute to total battery current ($I_{battery}$) but have their values individually displayed. <p>All battery management functions remain available.</p>
LOAD	<p>Shunt input is connected to a centralized load shunt located in the system. The total system Load current flows through this shunt to the load equipment. System may or may not have Shunt Monitors configured.</p> <p>Note: the shunt must be mounted in the grounded side of the system's DC bus. Possible damage may occur if the shunt is connected incorrectly.</p>	<p>Controller reports the following:</p> $I_{Load} = I_{plantshunt}$ $I_{battery} = \text{Unavailable}$ <ol style="list-style-type: none"> 1. If there are shunt monitor cards also installed: 2. Cards configured as monitoring a "Load" shunt shall not affect the total I_{Load} but have their value individually displayed. If there are cards configured as monitoring a "Battery" shunt it shall be assumed that all battery current flows through these shunts to and from the system batteries. These values shall be summed to be equivalent to the total battery current ($I_{battery}$) and override the previous equation for $I_{battery}$. Thus, the new $I_{battery}$ is $I_{battery} = \sum I_{battery\ shunt\ monitors}$ <p>All battery management features shall be available.</p>
NONE	<p>Shunt input may or may not be connected to a shunt located in the system. There are no "Shunt Monitors" configured in the system.</p> <p>Shunt input may or may not be connected to a shunt located in the system. System has Shunt Monitors configured in the system.</p> <p>Note: even if not being used and centralized shunt must be mounted in the grounded side of the system's DC bus. Possible damage may occur if the shunt is connected incorrectly.</p>	<p>Controller reports the following:</p> $I_{Load} = \sum I_{Rect}$ $I_{battery} = \text{Unavailable}$ <ol style="list-style-type: none"> 1. If cards are configured to monitor "Battery" shunts, it shall be assumed that all battery current flows through these shunts to and from the system batteries and shall be summed to be equivalent to the total battery current ($I_{battery}$). 2. Cards configured as monitoring a "Load" shunt shall not affect the total I_{Load} but have their values individually displayed. <p>Thus, the controller reports the following:</p> $I_{battery} = \sum I_{battery\ shunt\ monitors}$ $I_{Load} = \sum I_{Rect} + \sum I_{battery\ shunt\ monitors}$ <p>Where $I_{battery\ shunt\ monitors}$ is negative for current into the battery and positive for current out of the battery.</p> <p>Note: If there are no Shunt Monitors configured as battery then:</p> $I_{battery} = \text{Unavailable}$ $I_{Load} = \sum I_{Rect}$

Table 3 Current Calculations

Shunt Type	System Configuration	Controller Operation
	Shunt input may or may not be connected to a shunt located in the system. System has Shunt Monitors configured in the system and all system loads are monitored. And The new "All Load Monitored" feature has been "Enabled".	<p>Cards configured to monitor "Battery" shunts are assumed to monitor all battery current to and from the system batteries and shall be summed to be equivalent to the total battery current ($I_{battery}$). In addition, all individual battery monitor values shall be displayed</p> <p>Cards configured as monitoring a "Load" shunt shall be summed to calculate the total I_{Load} and also have their individual values displayed.</p> <p>The controller reports the following:</p> $I_{battery} = \sum I_{battery\ shunt\ monitors}$ $I_{Load} = \sum I_{Load\ shunt\ monitors}$ <p>Note: If there are no Battery Shunt Monitors configured but the total load monitored is enabled, then the total battery current shall be calculated as follows:</p> $I_{battery} = \text{Unavailable}$ $I_{Load} = \sum I_{Load\ shunt\ monitors}$ <p>Recharge current feature shall also be made unavailable.</p>

Contactors

Items in this web page are used to define the different parameters and thresholds for managed Low Voltage Disconnect (LVD) contactors. Clicking on a specific "Click to update" position will provide the associated parameters for the selected LVD type. The Pulsar Edge controller utilizes distribution monitoring and control boards to control contactors. These boards include the QS871 and NE872 modules. Each of the boards in the system must be assigned to LVD contactor control by appropriately configuring a unique board ID on the board and associating it to a specific contactor function at the controller.

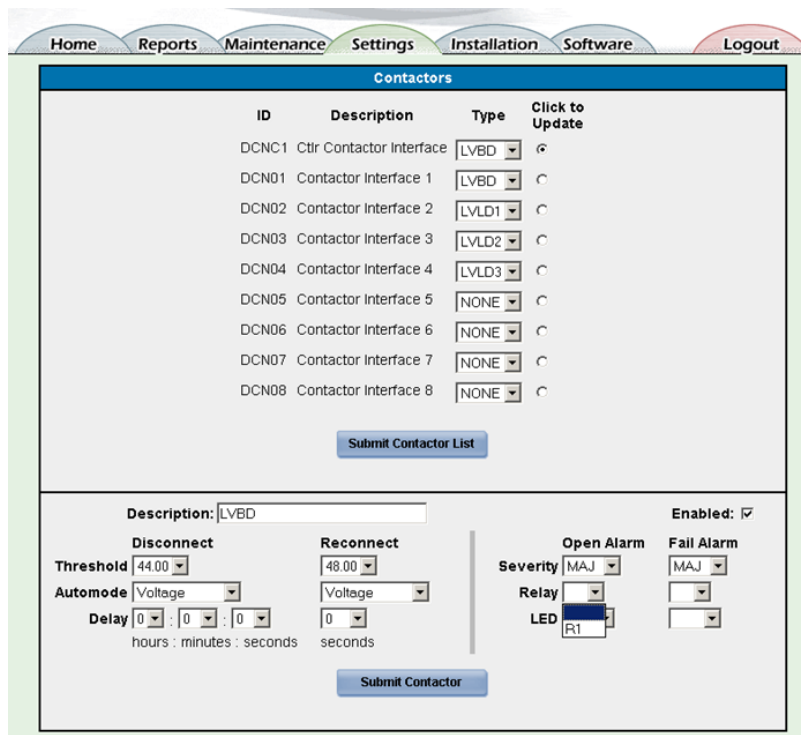

ID1-8 (DCN01-DCN08)	Associates the ID numbers set on the distribution monitoring boards (NE872/QS871) to one of four independent set of contactor controls. By default, these contactor controls are: LVBD (Low Voltage Battery Disconnect), LVLD1 (Low Voltage Load Disconnect 1), LVLD2 (Low Voltage Load Disconnect 2), and LVLD3 (Low Voltage Load disconnect 3).
------------------------	--

The Pulsar Edge has assigned each unique board ID number as follows: ID1 to LVBD, ID2 to LVLD1, ID3 to LVLD2, and ID4 to LVLD3. Note: the text description used for the disconnect, such as “LVLD1”, can be renamed through the remote interfaces. Each of these assignments has its own unique programmable parameters described next. ID5 to ID8 have been assigned as NONE. Selecting NONE removes the ability of that particular distribution control board to control and external LVD.

Another part of the configuration is the parameters associated with the individual function assignments made in the previous section. Each LVD type (LVBD and LVLD1-3) can individually be enabled or disabled. Only the LVBD and LVLD1 are Enabled in standard controllers shipped from the factory. The LVD’s disconnect and reconnect method of operation used by the controller can be configured for each assignment. The method of disconnect or reconnect can be based on the traditional means of reaching a system bus voltage threshold (Voltage) or based on both reaching the system bus voltage threshold and an elapsed time from once the system has been placed on discharge (BD) and at least two or more rectifiers are reporting AC failures (Voltage/Time). The same Voltage and Voltage/Time mode of operation can also be selected for reconnecting LVDs. In this case the elapsed time configured is the time from once the reconnect voltage threshold has been reached. Note: selecting None for a reconnect mode will require manual intervention to shut the contactor. Selecting None for the disconnect mode will not allow a LVD to open. The Pulsar Edge has factory defaults of the following:

LVBD (Enabled)	Disconnect Mode (Voltage); Range: Voltage, Voltage/Time, None Disconnect Voltage (42.0V); Range: -39.0 to -50.0V Time Delay (0 min); Range: 0-300min Reconnect Mode (Voltage); Range: Voltage, Voltage/Time, None Reconnect Voltage (-48.0V); Range: -39.0 to -55.0V Time Delay (0 sec); Range: 0-300sec
LVLD1 (Enabled)	Disconnect Mode (Voltage); Range: Voltage, Voltage/Time, None Disconnect Voltage (-42.0V); Range: -39.0 to -50.0V Time Delay (0 min); Range: 0-300min Reconnect Mode (Voltage); Range: Voltage, Voltage/Time, None Reconnect Voltage (-44.0V); Range: 39.0 to -55.0V Time Delay (0 sec); Range: 0-300sec
LVLD2 (Disabled)	Disconnect Mode (Voltage); Range: Voltage, Voltage/Time, None Disconnect Voltage (-42.0V); Range: -39.0 to -50.0V Time Delay (0 min); Range: 0-300min Reconnect Mode (Voltage/Time); Range: Voltage, Voltage/Time, None Reconnect Voltage (-44.0V); Range: 39.0 to -55.0V Time Delay (30 sec); Range: 0-300sec
LVLD3 (Disabled)	Disconnect Mode (Voltage); Range: Voltage, Voltage/Time, None Disconnect Voltage (-42.0V); Range: -39.0 to -50.0V Time Delay (0 min); Range: 0-300min Reconnect Mode (Voltage); Range: Voltage, Voltage/Time, None Reconnect Voltage (-44.0V); Range: 39.0 to -55.0V Time Delay (0 sec); Range: 0-300sec

Date/Time/Temperature

Items in this web page are used to define the different parameters associated with the controller's date, time, and temperature units and formats.

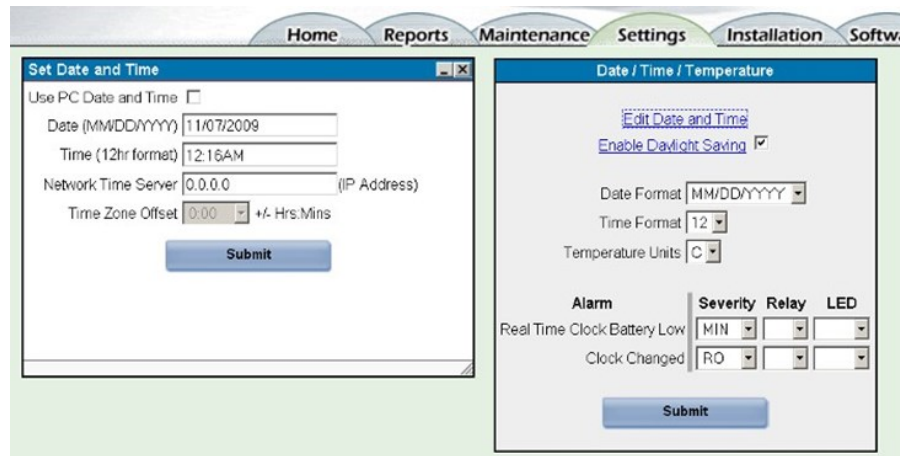

Date and DateFormat	Sets system date and format. The format for date can be selected from: mm/dd/yyyy, dd/mm/yyyy, yyyy/mm/dd, mm-dd-yyyy, yyyy-mm-dd, dd-mm-yyyy, mm/dd/yy, yy/mm/dd, dd/mm/yy, mm-dd-yy, yy-mm-dd, or dd-mm-yy and the format for time can be 12HR/24HR format. The factory default is Date: mm/dd/yyyy
Time and Time Format	Sets system date and format. The format for date can be selected from: mm/dd/yyyy, dd/mm/yyyy, yyyy/mm/dd, mm-dd-yyyy, yyyy-mm-dd, dd-mm-yyyy, mm/dd/yy, yy/mm/dd, dd/mm/yy, mm-dd-yy, yy-mm-dd, or dd-mm-yy and the format for time can be 12HR/24HR format. The factory default is Time: 12HR.
Use PC Date andTime	When selected, the controller will update its date and time to the connected users PC.
Network Time Server	When configured with a non-zero ("0.0.0.0") IP address the controller will automatically at 12:00AM each day connect to the given Network Time Server address and update its time and date using the configured Time Zone Offset. Note: when the NTP address is set it is necessary to reboot the controller for the feature to operate. The factory default IP is "0.0.0.0" which is disables the feature.
Time Zone Offset	Time offset from GMT. The range for this offset is between -14:00 and +14:00 Hrs:Mins. NTP address must be provided and controller rebooted for the Time Zone Offset to work properly. The factory default is 0:00 Hrs:Mins
Enable Daylight Saving	Enable or disable of automatic switch over with Daylight Saving. The factory default is Enabled.
Temperature Units	Selects between displaying temperature measurement in °C or °F.The factory default is °C.
Clock Battery Low	Automatic event generated by the controller when its internal lithium battery is low. The severity of the alarm can be set as desired.
Clock Changed	Any change to the Date or Time is an Event the controller detects. The severity of the alarm can be set as desired.

Alarm Test

When equipped with alarm output contacts, the Pulsar Edge provides a user the ability to manually test the system alarm output contacts. Wiring to monitoring systems can be tested in the field or factory using this feature. The duration of the alarm contact assertion can be configured from 5 to 300 seconds. Specific relays may also be selected. Following is a sample Alarm Test screen.

Alarm Test

Alarm Test Enable

Alarm Test Duration seconds

Test Power Major

Test Power Minor

Test R1

Test R2

Test R3

Alarm	Severity	Relay	LED
Alarm Test Active	<input type="text" value="RO"/>	<input type="text" value=""/>	<input type="text" value=""/>
Alarm Test Aborted	<input type="text" value="RO"/>	<input type="text" value=""/>	<input type="text" value=""/>

Branding/Styling

Pulsar Edge web pages contain references to OmniOn as well as the Pulsar Edge. These can be removed from the web pages by configuring Company and Product Headings. Clicking on the color wheels and pull-downs and trialing different colors is an effective way of using this feature.

Styling

Company Heading Company Coloring

Product Heading Product Coloring

Bar Style Bar Coloring

Page Primary Coloring

Page Secondary Coloring

Reserve Group Battery Management

Items in this section of the Settings pages are used to configure the various parameters associated with the battery reserve system. A sample screen shot follows along with parameter descriptions.

Battery

Number of Strings

Battery Type

String Capacity AH

Enable Recharge Current Limit

Recharge Current Limit A

Imbalance Threshold

String End of Discharge Voltage

High Temperature Disconnect C

Alarm	Severity	Relay	LED	Threshold	Float	Boost
Battery On Discharge	<input type="text" value="MIN"/>	<input type="text" value=""/>	<input type="text" value="ALM"/>		<input type="text" value="51.00"/>	<input type="text" value="51.00"/>
Very Low Voltage	<input type="text" value="MAJ"/>	<input type="text" value=""/>	<input type="text" value="ALM"/>	<input type="text" value="46.00"/> V		
Very High Battery Temperature	<input type="text" value="MAJ"/>	<input type="text" value=""/>	<input type="text" value=""/>	<input type="text" value="65"/> C		
High Battery Temperature	<input type="text" value="MIN"/>	<input type="text" value=""/>	<input type="text" value=""/>	<input type="text" value="55"/> C		
Low Battery Temperature	<input type="text" value="MIN"/>	<input type="text" value=""/>	<input type="text" value=""/>	<input type="text" value="-10"/> C		
Very Low Battery Temperature	<input type="text" value="MAJ"/>	<input type="text" value=""/>	<input type="text" value=""/>	<input type="text" value="-20"/> C		
Check Battery	<input type="text" value="MIN"/>	<input type="text" value=""/>	<input type="text" value=""/>			
Open String	<input type="text" value="MAJ"/>	<input type="text" value=""/>	<input type="text" value=""/>			
Voltage Imbalance	<input type="text" value="MIN"/>	<input type="text" value=""/>	<input type="text" value=""/>			
Thermal Probe Fail	<input type="text" value="MIN"/>	<input type="text" value=""/>	<input type="text" value=""/>			

<p>Number Of Strings</p>	<p>The total number of battery string installed in the system. Uses for inventory purposes, state of charge, and initial reserve time calculations. Available range is 0-16 with factory default of zero strings for VRLAs.</p>
<p>Battery Type</p>	<p>The type of batteries used in the system can be selected from the following battery types loaded in the Standard controller:</p> <ul style="list-style-type: none"> • M12V90FT • M12V105FT • M12V155FT • NCX-125 • NCX-80 • NSB110FT • NSB170FT • NSB60FT • SBS-145 • SBS-170 • TEL12-90 • TEL12-105 • XE60 • 12A100FT • 12A150FT • 12AVR145 • 12FAT130 • 12FAT155 • 12IR150/150LP • IR40EC • Generic VRLA (Valve Regulated Lead Acid) • Generic FLOODED (flooded lead acid) • Generic NiCad (Nickel Cadmium) • Generic Li-LMP (Lithium Metal Polymer) • Generic Li-ELITE (Lithium ELITE) <p>Once selected the user has the opportunity to automatically accept the standard defaults for all battery Type related features.</p> <p>Parameters such as float voltage, float alarms, thermal compensation parameters, etc. are automatically adjusted if defaults are accepted. Note: In custom controller configurations this list can be configured to limit battery selection to what is applicable. Battery models can also be removed or added in the field as desired. The system factory default is Valve-Reg.</p>
<p>String Capacity</p>	<p>Capacity of an individual battery string used to derive the total installed system battery capacity, state of charge and initial reserve time. Value must be entered for Generic battery types but is configured for specific battery models mentioned previously. The value configured should be the rating to 1.75V at an 8-hr discharge rate. The available range is 0-9999 AH with factory default of 0AH for Generic Valve-Reg.</p>
<p>Enable Recharge Current Limit Recharge Current Limit</p>	<p>Enable or Disable battery recharge limiting and set recharge current limit. When enabled, the controller regulates current into the batteries per limit setting. Recharge current limit is factory Disabled. The current limit range is 5 to 1000A with a factory default of 50A for Valve-Reg batteries.</p>

Voltage Imbalance	User defined voltage threshold for a mid-string voltage imbalance alarm. Range is 1.4 to 3.0 Volts with a factory default of 1.7V for Valve-Reg batteries. This alarm is only generated after batteries have been sitting on float for a minimum of 12 hours and the total battery current is less than 3A.
String End Of Discharge Voltage	The user defined system bus voltage at which the batteries are considered to be at the end of their reserve capability for manual battery testing (End of Discharge). This end-of-discharge voltage is used for automatic and opportunistic reserve time calculations. This setting has a range of -40.25V to -48.75V with factory default of -42.00V and +19.25V to +25.35V with factory default of +21.00V.
High Temperature Disconnect	Configurable battery temperature value at which the battery contactor will be forced to open. This setting has a range of 30°C to 90°C with factory default of 75°C.
Battery On Discharge(BD) Float	DC bus threshold setting that determines when the system is determined to be operating either completely or partially on battery reserve and when the BD alarm is asserted. The threshold is set from -46.00V to -55.00V with a factory default of -51.00V and +23.00V to +28.00V with default of +25.54V.
Battery On Discharge(BD) Boost	DC bus threshold used during Boost mode of operation to determine when the system is determined to be operating either completely or partially on battery reserve and when the BD alarm is asserted. The threshold can be set from -46.00V to -55.00V with a factory default setting of -51.00V and +23.00V to +28.00V with default of +25.54V.
Very Low Voltage	DC bus alarm threshold typically used as a second Low Voltage indication as well as an imminent system shutdown due to discharging batteries or a very low output voltage (VLV). Threshold is set from -40.00V to -51.00V with a factory default of -46.00V and +20.00V to +25.50V with a factory default of +23.00V.
Very High Battery Temperature	A second battery temperature threshold with a configurable range of 30°C to 85°C with a factory default of 65°C.
High Battery Temperature	A battery temperature threshold with a configurable range of 30°C to 85°C with a factory default of 55°C.
Low Battery Temperature	A battery temperature threshold with a configurable range of -40°C to 10°C with a factory default of -10°C.
Very Low Battery Temperature	A second battery temperature threshold with a configurable range of -40°C to 10°C with a factory default of -20°C.
Various Other Alarm severities	Includes the ability to configure the severity, Relay, and LED assignments for the Check Battery, Open String, Mid-String Voltage imbalance, and Thermal Probe Fail alarm events.

Temperature Compensation

Items in this section of the Settings pages are used to configure the various parameters associated with the battery temperature compensation. A sample screen shot follows along with parameter descriptions.

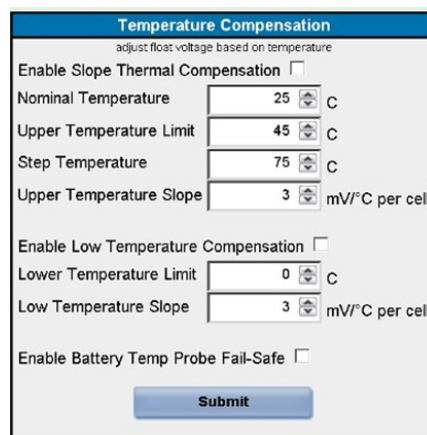

Enable Slope Thermal Compensation	When Enabled it allows the controller to automatically adjust or compensate the system output voltage based upon the highest battery temperature monitored by the controller. This feature must be enabled in order to use High and or Low Temperature compensation. Factory default is disabled.
Nominal Temperature	The nominal temperature is the battery temperature which there is no battery voltage compensation due to temperature. Slope Thermal compensation will be active if the feature is enabled for temperatures above or below this temperature threshold. The nominal battery temperature range is from 15 to 30°C with a factory default setting of 25°C.
Upper Temperature Limit	The Upper Temperature Thermal Compensation Limit is the upper temperature thermal limit at which high temperature thermal compensation is stopped and the DC voltage is no longer decreased according to the configured linear slope rate. This temperature threshold limit can be set from 30°C to 55°C with a factory default setting of 55°C.
Step Temperature	The High Temperature Voltage Step Down Temperature threshold is the temperature at which the system controller will adjust the rectifiers to set the DC bus voltage down by another .17V per cell. This battery step down temperature can be set from 45°C to 85°C. A 10°C hysteresis is built into this feature. The factory default setting is 75°C.
Upper Temperature Slope	The high or upper temperature decrease rate establishes the linear slope rate that the controller utilizes to decrease the system DC voltage from the configured nominal temperature value to the High Temperature Compensation Limit. The high temperature slope setting (rate of decrease) can be set from -1mV/°C per cell to -10mV/°C per cell in -.1mV/°C per cell increments with a factory default of -3mV/°C per cell.
Enable Low Temperature Compensation	Allows the controller to automatically perform Low Temperature Compensation by adjusting or compensating the system output voltage based upon the highest battery temperature monitored by the controller independently from High Temperature compensation. Note: the general Slope Thermal Compensation feature must also be enabled in order to use Low Temperature compensation which is factory default disabled.
Lower Temperature Limit	Low Temperature Thermal Compensation Limit is the lower temperature thermal limit at which low temperature thermal compensation is stopped and the system DC voltage is no longer increased per configured linear slope rate. This temperature threshold limit can be set from -5°C to 20°C with a factory default setting of 0°C.
Low Temperature Slope	The low temperature slope increase rate establishes the linear slope rate that the controller utilizes to increase the system DC voltage from the configured Battery Nominal Temperature value to the Low Temperature Compensation Temperature Limit. The low temperature slope setting (rate of increase) can be set from 1mV/°C per cell to 10mV/°C per cell in .1mV/°C per cell increments with a factory default setting of 3mV/°C per cell.
Enable Battery Temp Probe-Fail Safe	When this feature is Enabled the controller will monitor each battery temperature probe attached. Upon the detection of a failed probe, the controller will default the system float voltage to a Fail-Safe voltage determined by the STC settings. The Fail-Safe voltage is the calculated voltage determined by the upper high compensation temperature limit. The factory default setting Disabled.

Boost

Items in this section of the Settings pages are used to configure the various parameters associated with the Boost feature. The Boost function allows battery charging to be expedited by raising the system voltage to Boost level for a set time. A sample screen shot follows along with parameter descriptions.

Auto Mode	Field allows the automatic Boost feature to be Disabled or be based upon a “Timed” or “Current” based algorithm. When set to Time, Boost will utilize a multiplication factor of the actual time of the last BD. When set to Current, Boost will end once the monitored battery current reaches the programmed current threshold. The factory default setting for Automatic Boost is Disabled.
Timed Manual Duration	Defines the maximum time duration the system can remain in the Boost mode of operation. The value can be set from 1 to 80 hour with a factory default setting of 1 hour.
Auto Multiplication Factor	Multiplication factor to use with of the actual time of the last BD for the time duration of Boost. The value can be set from .1 to 9 with a factory default setting of .5.
Current Threshold	Configured battery current threshold during Boost that will end the Boost operation and return the system back to Float. The value can be set from 1 to 999 Amps with a factory default setting of 5 Amps.
Pages with Boost settings	Provides a quick link to other pages with configuration items associated with Boost.

Battery Types

Items in this section of the Settings pages are used to configure the various battery models and the parameters associated with them. A maximum of 25 battery models can be stored in the controller. Batteries can be added and deleted simply by clicking on the correct link. Adding a battery requires a description of the battery model, the general technology class the battery falls under, and the 8-hour to 1.75V amp-hour rating of the battery. A sample screen shot follows along with parameter descriptions.

Model	Technology	AmpHours
GENERIC	FLOODED	0
GENERIC	LI-ELITE	63
GENERIC	LI-LMP	63
GENERIC	NICD	0
GENERIC	VALVE-REG	50
12A100FT	VALVE-REG	96
12A150FT	VALVE-REG	145
12R150/150LP	VALVE-REG	145
3A125-33L	VALVE-REG	2000
3A95-21L	VALVE-REG	950
3A95-27L	VALVE-REG	1235
3A95-33L	VALVE-REG	1520
6A95-13L	VALVE-REG	570
6A95-15L	VALVE-REG	665
IR30EC	VALVE-REG	27
IR40EC	VALVE-REG	35
LS4V63FTX	LI-ELITE	63
NCX-125	NICD	125
NCX-80	NICD	80
NSB110FT	VALVE-REG	110
NSB170FT	VALVE-REG	170
NSB60FT	VALVE-REG	60
SE48S80	LI-LMP	80
TEL12-105F	VALVE-REG	100

Voltage Modules

Items in this section of the Setting pages are used to configure the various alarms and description attributes for the ES771 mid-string voltage modules. Following is a sample screen from a system with two ES771 modules.

Voltage Modules		
Module	Channel	Description
1	1	String 1 Midpoint
1	2	String 2 Midpoint
1	3	String 3 Midpoint
2	1	String 4 Midpoint
2	2	String 5 Midpoint
2	3	String 6 Midpoint

Alarm	Severity	Relay
Shorted Cell	MIN	
Module Failure	MIN	
ID Not Configured	MAJ	
Duplicate ID	MAJ	

Submit

Description	Description field of up to 20 characters to describe the battery string connection for every monitoring input. The factory default for this description is String # Midpoint.
Various Related Alarms	Configuration of the severity and alarm relay assignment for associated ES771 Mid-String Voltage monitoring alarms such as Shorted Cell (Mid-String Voltage Imbalance), ES771 module failure, ES771 module ID not configured properly, and ES771 module with Duplicate ID.

Battery Testing

This section includes all the parameters required for battery testing through manual or automatic means. Configuration for manual test type and automatic test are configured here. Other items like the system test end-voltage for manual battery test, test interval, start date, start time, time from last battery on discharge BD, and enable/disable for periodic battery test are also configured through this screen. The rectifier voltage during battery discharge testing and system reserve time low alarm threshold are also available. Many of the items are self-explanatory. Descriptions are provided for those that are not. Following is a sample Battery Test screen.

Battery Testing					
Manual Test Type	Amp-Hours Out				
Rectifier Voltage During Test	22 V				
Amp Hours Out Test					
Amp Hours to be removed	56 Ah				
Timed Test					
Alarm Voltage	23 V				
Test Duration (hr:min:sec)	0	0	0		
Auto Test					
Test Type	Amp-Hours Out				
Test Date	12/31/2099 MM/DD/YYYY				
Test Start at Hour	10				
Delay Test After BD	8 Hrs				
Months between Tests	4				
Alarm	Severity	Relay	LED	Threshold	
Reserve Time Low	RO			0:00	0:00 hh:mm
Real-Time Reserve Low	RO			0:00	0:00 hh:mm
Battery Test Active	RO				
Check Battery	MIN				

Submit

<p>Manual Test Type Automatic TestType</p>	<p>Selects between Disabled, 20%, Timed, and Amps-Hours Out test methods. When Disabled, battery test will not be permitted. 20% utilizes a patented algorithm that discharges the battery reserve by Bout 20% from the detection of a coup de fouet and calculates are serve time. Selecting Time allows the discharge test to be run against a user configured time threshold. Using Amp-Hours Out allows a configured amp-hours amount to be removed from the nominal string capacity. These tests can be run Manually or Automatically. Manual tests can be implemented through the front panel or remote means. In addition, the PBT/TR input can be used to assert a Plant Battery Test (PBT). When PBT/TR is used for battery Test, the controller will monitor the assigned input and place the plant into the battery test mode when the input is asserted.</p> <p>Specific Edge controllers utilize the IN007 input for PBT. This input is Labeled as PBT/TR. To use the input, the Remote Group Standby (TR) must be disabled and PBT enabled. This input can also serve as a general purpose input by configuring the alarm assignment to something else. Manual battery testing is factory Disabled.</p>
<p>Rectifier Voltage During Test</p>	<p>The rectifier voltage during test parameter defines the output voltage the rectifiers will go to upon the initiation of a battery test. The range for this setting goes from -42.00 to -52.00 Volts with a default of 42.00V and +21.00 to +26.00 Volts with a default of +21.00V.</p>
<p>Timed Test Alarm Voltage</p>	<p>Timed Test Alarm Voltage threshold is a user configured voltage threshold that the timed discharge test utilizes to determine pass or Fail based upon the program Test Duration entered. If the system DC bus does not reach this voltage during the programmed test duration, then the test passes. Otherwise battery test failed is generated.</p>
<p>Reserve Time Low</p>	<p>This alarm threshold is checked only when batteries are considered in a stable state of charge. It is a coulomb count of charge current into the batteries that is compared to the Amp Hours configured in the controller. If no strings are entered this alarm is not generated. This feature is meant for capacity planning. It provides an indication that the system load has exceeded the configured value of installed battery capacity. This alarm is latched and can be cleared with the clear events operation. The range on this alarm is from 0.0 to 100.0 hours with a factory default of 0.0 hours.</p>
<p>Real-Time Reserve Low</p>	<p>This alarm threshold is checked whether the battery state of charge is stable or not. It is active when batteries are on discharge. It is meant to provide an indication of the battery reserve during a system discharge considered in a stable state of charge. The range on this alarm is from 0.0 to 100.0 hours with a factory default of 0.0 hours.</p>

Power Group

Rectifier

This section provides access to configure the various parameters, thresholds and alarms associated with the rectifiers.

The screenshot shows a web-based configuration interface for Rectifiers. It is divided into several sections:

- Rectifiers:** Contains input fields for Float Set Point (54.5 V), Boost Set Point (54.5 V), Float Internal High Voltage Shutdown (58.5 V), Boost Internal High Voltage Shutdown (58.5 V), Float Current Limit (100 %), Boost Current Limit (100 %), and On Threshold (44 %).
- Enable Redundancy Check:** A checkbox that is currently unchecked.
- Remote Rectifier in Standby:** A checkbox that is currently unchecked.
- Enable Remote Group Standby:** A checkbox that is currently unchecked.
- Remote Group Standby Rectifiers:** A dropdown menu showing 'G01' and 'G02'.
- Energy Efficiency:** Contains an 'Enable' checkbox (unchecked), 'Efficiency Target Capacity' (70 %), 'Efficiency Turn On Capacity' (76 %), 'Inter-Rectifier Delay' (10 minutes), and 'Initial Delay' (12 minutes).
- Submit:** A blue button to save the configuration.
- Alarms and Thresholds Table:**

Alarm	Severity	Relay	LED	Float	Boost
High Voltage	MIN	2	2	56	56
Very High Voltage	MAX	2	2	57	57
AC Fail	MIN	2	2		
Multiple AC Fail	MAX	2	2	2	# Rectifiers
Rectifier Fail	MIN	2	2		
Redundancy Loss Alarm	MIN	2	2	1	# Rectifiers
Rectifier Current Limit	FO	2	2		
Manual Off	MIN	2	2		
Multiple Manual Off	MAX	2	2	2	# Rectifiers
Multiple Rectifier Fail	MAX	2	2	2	# Rectifiers
Rectifier Fan Fail	MIN	2	2		
- Submit Alarm Settings:** A blue button at the bottom of the table.

Float Set Point	Parameter sets the value that primary (rectifier) DC bus will be set and regulated. System Float Voltage set-point adjustable from - 42.00V to -56.50V with a factory default of -54.48V for 48V VRLA power systems +21.00V to +28.00V with a factory default of +27.24 for 24V VRLA power systems.
Boost Set Point	DC bus voltage set-point during the Boost mode of operation. Boost (Set point) is adjustable from -48.00V to -58.00 with a default setting of -55.20V and from +22.00V to +30.00 with a default setting of +27.24V.
Float/Boost Internal High Voltage Shutdown	This is an Independent High Voltage Shutdown threshold during the Float or Boost mode of operation that is sent to and stored in the rectifiers and is used by each rectifier for independent high voltage monitoring. The threshold can be set from -50.00V to -60.00V with a default setting of -58.50V and from +26.00V to +31.75V with a default setting of +29.25V.
Float/Boost Current Limit	Adjustable from 30-110%. At 100% or greater the rectifier will output its name plate rating and truly act as constant power rectifiers. Settings below 100% will be current limited to that percentage of the rectifier's name plate current rating.
Rectifier On Threshold	The system DC bus threshold that rectifiers placed into Standby will automatically be turned on. This value can be set between -40.00V and -51.00V with a default of -44.00V and +20.00V and +25.00V with a default of +22.00V.
Enable Redundancy Number Of Redundant Rectifiers	When Enabled, an alarm is automatically generated when the rectifier capacity On-line in the system falls below N+X based on The present system load. X is the desired number of rectifiers to check for redundancy. The factory default for this feature is enabled and X=1.
Remote Rectifier In Standby	Provides the ability to disable or enable the capability of placing a rectifier into Standby operation through remote means such as the network, modem, or local Craft port.
Enable Remote Group Standby	When enabled, provides the ability to hold off a user configured group of rectifiers when appropriate contact closure is received on The assigned input or when the command is issued from the Maintenance page or issued remotely over the network or Craft port. The feature is also called Group Standby (TR). Note: appropriate Pulsar Edge controllers have this feature utilize the IN007 input typically located on J1.1 of appropriate CP and SPS shelves. This input is labeled as PBT/TR. To use the input for PBT the Group Standby feature must be disabled and the Battery Manual Test Type must be enabled. This input can also serve as a general purpose input by configuring the alarm assignment to something else. The factory default for the Group Standby feature is Disabled.
Remote Group Standby Rectifiers	Provides a list of all system rectifiers. Users can select specific rectifiers to put into Remote Standby by checking the appropriate boxes. The factory default for this feature is to have no rectifiers assigned.
Energy Efficiency Enable	When Enabled, the controller will engage its Adaptive Rectifier Management (ARM) algorithm to optimally manage the system rectifier efficiency. Rectifiers that are not required to support the system's present load based upon the configured Efficiency Target Capacity will automatically be placed into standby. The load will be constantly monitored and any rectifiers necessary to support additional load will be turned on. In addition, rectifiers placed in Standby are cycled over time to insure they remain operable. The factory default for this feature is Disabled.
Efficiency Target Capacity	The capacity percentage that the system controller tries and maintains all system rectifier outputs. The value can be set from 20% to 95% with a factory default of 70%.
Efficiency Turn On Capacity	The capacity percentage of a system rectifier when reached that the system controller will take a rectifier out of Standby and place it into service. The value can be set from 25% to 100% with a factory default of 76%.
Inter-Rectifier Delay	The value of time the controller will take before placing the second or additional system rectifiers into the standby mode of operation. This value can be set between 1 and 30 minutes with a factory default setting of 10 minutes.
Initial Delay	The value of time the controller will monitor and take before placing the first system rectifier into the standby mode of operation. This value can be set between 1 and 30 minutes with a factory default of 10 minutes.

High Voltage Float and High Voltage Boost	These alarms indicate an abnormally high float or boost output voltages (HFV) on the primary DC bus. The controller does not attempt to shut the offending unit down during this first level. These thresholds can be set from -50.00V to -60.00V with a factory of -56.00V for both settings in 48V and from +24.75V to +29.75V with a factory of +27.74V for both settings in 24V.
Very High Voltage Float and Very High Voltage Boost	These alarms are the High Voltage Shutdown Alarm (HVSD) threshold for the primary DC bus during float and boost, respectively. When reached the controller will send out the HV shutdown command to all rectifiers so that the offending rectifier will shut itself down. The threshold can be set from -50.00V to -60.00V with factory default thresholds of -57.00V for 48V and from +25.74V to +31.75V with factory default thresholds of +28.24V for 24V.
AC Fail	A single rectifier in the system has reported an AC failure to the controller.
Multiple AC Fail	Multiple rectifiers in the system have reported AC failures to the controller. The number of rectifiers required to report an ACF is configurable based on the number of rectifiers in the system. The Factory default for this threshold is 2.
Rectifier Fail	A single rectifier in the system has reported a rectifier failure to the controller.
Redundancy Loss Alarm	An alarm generated when the configured minimum number of redundant rectifier is lost when compared to the present system Load. The factory default for this threshold is 1.
Rectifier Current Limit	One or more rectifiers in the system reported they are operating in current limit mode.
Multiple Rectifier fail	Multiple rectifiers in the system have reported rectifier failures to the controller. The number of rectifiers required to report a rectifier failure is configurable based on the number of rectifiers in the system. The factory default for this threshold is 2.
Rectifier Fan Fail	A single rectifier in the system has reported a rectifier fan failure to the controller.

Converter

This section provides access to configure the various parameters, thresholds and alarms associated with the converters.

Converter

Voltage Set-Point:

Converter Current Limit:

Internal High Voltage Shutdown:

Low Voltage Discon. Threshold:

Low Voltage Recon. Threshold:

Low Voltage Disconnect Enable:

Remote Converter in Standby:

Enable Redundancy Check

Alarm	Severity	Relay	LED	Threshold
Converter High Voltage Major	MAJ	<input type="checkbox"/>	<input type="checkbox"/>	56
Converter High Voltage Minor	MIN	<input type="checkbox"/>	<input type="checkbox"/>	54
Converter Very Low Voltage	MIN	<input type="checkbox"/>	<input type="checkbox"/>	46
Multiple Converter Fail	MAJ	<input type="checkbox"/>	<input type="checkbox"/>	8
Converter Redundancy Loss	MIN	<input type="checkbox"/>	<input type="checkbox"/>	1
Converter Fail	MIN	<input type="checkbox"/>	<input type="checkbox"/>	
Converter Distribution Fuse	MAJ	<input type="checkbox"/>	<input type="checkbox"/>	
Converter ID Conflict	MAJ	<input type="checkbox"/>	<input type="checkbox"/>	
Converter Fan Minor	MIN	<input type="checkbox"/>	<input type="checkbox"/>	

Set-Point	Parameter sets the value that secondary (converter) DC bus voltage will be set and regulated. The converter output voltage set-point is adjustable from -46.00V to -54.5V and +23.0V to +27.2V with a factory default of -52.0V and +26.0V for 48V and 24V converter outputs, respectively.
Current Limit	Adjustable from 30-110%. At 100% or greater the converter outputs its nameplate rating and acts as constant power unit. Settings below 100% will be current limited to that percentage of the converter's name plate current rating.
HV Shutdown	This is an Independent High Voltage Shutdown threshold that is sent to and stored in the converters that is used by each converter for independent high voltage monitoring. The threshold can be set from -50.0V to -60.0V or +25.0 to +30.0V with a factory setting of - 58.0V and +29.0V for 48V and 24V outputs, respectively.
Low Voltage Disconnect	Enable or Disable for a feature that allows attached converters to be placed into Standby once an input voltage threshold is reached. The factory default for this feature is Disabled.
Disconnect	Converter input voltage threshold to be used to place all converters into Standby. The converter disconnect threshold is adjustable from -40.0V to -50.0V and +20.0V to +25.0V with a factory default of - 46.0V and +23.0V for 24V and 48V output converters, respectively.
Reconnect	Converter input voltage threshold to be used to return all converters from Standby to On. The converter reconnect threshold is adjustable from -44.0V to -54.0V and +22.0V to +27.0V with a factory default of -52.0V and +26.0V for 24V and 48V output converters, respectively.
Voltage Alarms	<p>Has the ability to set similar secondary DC bus level alarms as found with the rectifiers and the primary DC bus. This includes Very High Major, High Minor, and Very Low voltage.</p> <p>Very High Major</p> <p>The High Voltage Shutdown Alarm (HVSD) threshold for the secondary DC bus. When reached, the controller will send out the HV shutdown command to the serial converters so that the offending converter will shut itself down. The threshold can be set from -50.0V to -60.0V or +25.0 to +30.0V with a factory default setting of -56.00 and +28.5V for 48V and 24V converter outputs, respectively.</p> <p>High Major</p> <p>This alarm indicates an abnormally high output voltage on the secondary DC bus. The controller does not attempt to shut the offending unit down. The threshold can be set from -48.0V to -60.0V or +24.0 to +30.0V with a factory default setting of -54.00 and +27.0V for 48V and 24V for converter outputs, respectively.</p> <p>Very Low</p> <p>Secondary DC bus alarm threshold used to indicate something dragging the bus to an undesired voltage level or an incorrect setting. The threshold can be set from -40.0V to -54.0V or +20.0 to +27.0V with a factory default setting of -46.0V and +23.0V for 48V and 24V for converter outputs, respectively.</p>

Part Numbers

This section provides access to add a secondary identification of company number for a specific component of the power system. The number is shown under inventory. Following is a sample screen.

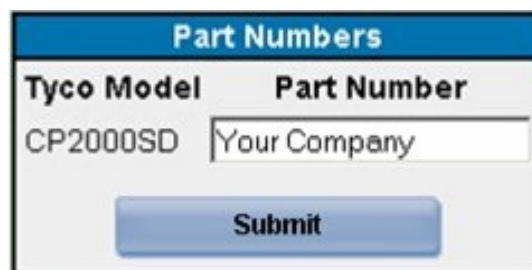

The screenshot shows a web form titled "Part Numbers". It contains two columns: "Tyco Model" and "Part Number". Under "Tyco Model", the value "CP2000SD" is displayed. Under "Part Number", there is a text input field containing the placeholder text "Your Company". Below these fields is a blue "Submit" button.

Communications Group

Passwords

This section provides access to perform password administration. Administrator level access is required. There are three standard levels of access provide by the controller: User (Read Only), Super-User (Read/Write without password administration capabilities, and Administrator (Read/Write with password administration capabilities). The controller also has the ability to management User names and assigned passwords.

Passwords can be up to 15 characters. Sample screens for both are shown below.

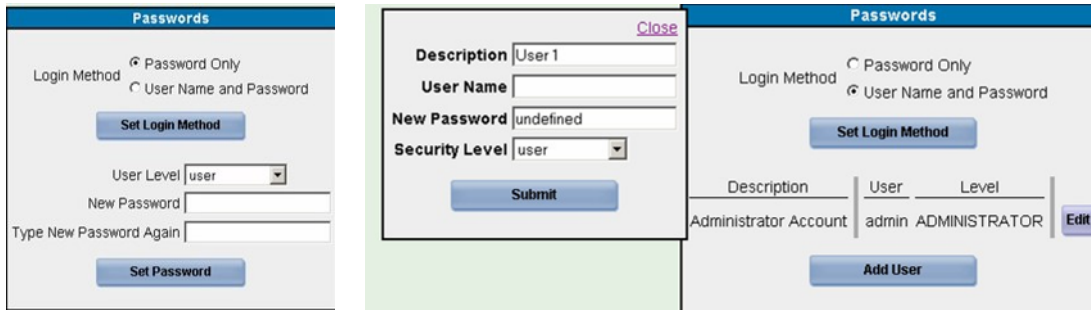

Security

This section provides the ability to establish various phone numbers over traditional telephone line connection for alarm calls. Also contained in this section are a couple of plant level features.

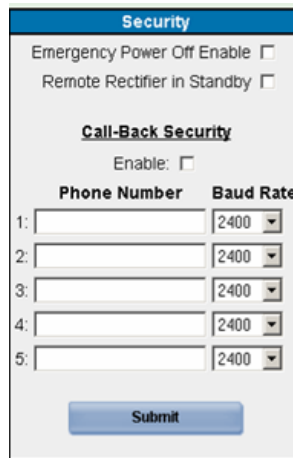

<p>Emergency PowerOff Enable (EPO)</p>	<p>If enabled, the remote Emergency Power Off (EPO) feature allows the controller to detect the occurrence of a contact closure and force open all battery contactors in the system. The battery contactor will open five seconds after the contact has been asserted. Once the contact is removed, the battery contactor will be re-asserted to its previous operational state. The factory default for this feature is Disabled.</p>
<p>Remote Rectifier In Standby</p>	<p>Provides the ability to disable or enable the capability of placing a rectifier into Standby operation through remote means such as the network, modem, or local Craft port.</p>

Network

The Pulsar Edge supports network access to almost all controller functions including all voltage and temperature readings, current alarms, and alarm history. It supports a web-based user interface using standard browsers such as Microsoft Internet Explorer®. It can provide plant alarm and control information to a distributed or centralized Network Operation Center (NOC) using the Simple Network Management Protocol (SNMP) or the Transaction Machine Language (TLI), which allow the Pulsar Edge to provide alarm information to the NOC for integrated network management. The Pulsar Edge provides network access and control capability for users under the HTTP, Telnet, FTP, SMTP, SNMP, and TLI protocols.

This section provides access to configure all the network parameters for the controller. The primary port is Network Port 1 which configures the integrated 10/100Base-T Ethernet port. The controller has the ability to utilize an external network card that attaches to the RS232 Craft port and can provide access to a second network connection. This connection is called Network Port 2. Port 2 is reserved for a second integrated Ethernet port in the future. Following is a sample screen of the port information typically obtained from a network administrator as well as descriptions for the fields. Brief description of some of the other features included in the controller is provided.

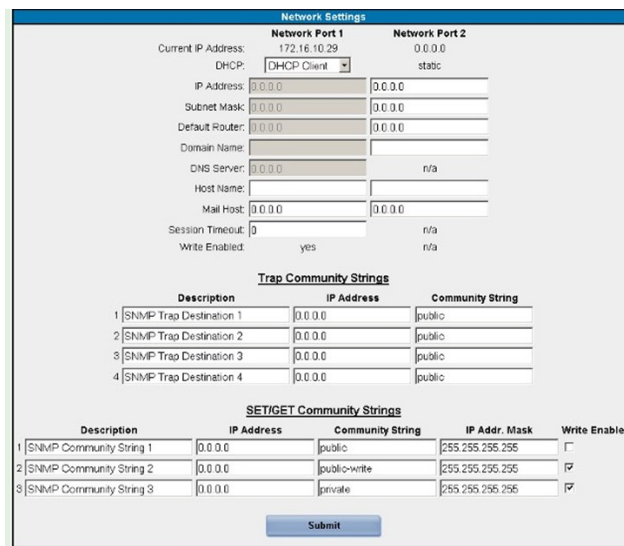

Network Port 1		Network Port 2	
Current IP Address:	172.16.10.29	0.0.0.0	
DHCP:	DHCP Client	static	
IP Address:	0.0.0.0	0.0.0.0	
Subnet Mask:	0.0.0.0	0.0.0.0	
Default Router:	0.0.0.0	0.0.0.0	
Domain Name:			
DNS Server:	0.0.0.0	n/a	
Host Name:			
Mail Host:	0.0.0.0	0.0.0.0	
Session Timeout:	0	n/a	
Write Enabled:	yes	n/a	

Trap Community Strings		
Description	IP Address	Community String
1 SNMP Trap Destination 1	0.0.0.0	public
2 SNMP Trap Destination 2	0.0.0.0	public
3 SNMP Trap Destination 3	0.0.0.0	public
4 SNMP Trap Destination 4	0.0.0.0	public

SET/GET Community Strings				
Description	IP Address	Community String	IP Addr. Mask	Write Enabled
1 SNMP Community String 1	0.0.0.0	public	255.255.255.255	<input type="checkbox"/>
2 SNMP Community String 2	0.0.0.0	public-write	255.255.255.255	<input checked="" type="checkbox"/>
3 SNMP Community String 3	0.0.0.0	private	255.255.255.255	<input checked="" type="checkbox"/>

DHCP (Network Settings)

The access type and the Dynamic IP addressing mode are set in this section. The Dynamic IP address mode sets the IP address operation mode of the integrated Ethernet port on the Pulsar Edge.

This port has been set to act in DHCP (Dynamic Host Configuration Protocol) Client mode. This mode of operation assumes that the network will automatically provide an IP address to the controller. The port may also be configured to use a “Static” IP address which is configured by the user. The Static and Client modes of operation allow the Pulsar Edge’s port to be configured to operate plugged into the network.

It can also be used in a “DHCP- Server” mode to provide Craft port functionality. In this mode the Pulsar Edge up 192.168.2.1 which should be used as the destination address in a user’s browser.

Note: once this parameter is changed, the controller must be re- booted by removing power from the unit by removing and re- inserting the unit into the shelf.

IP Address *	Internet Protocol address (Static) assigned to the Pulsar Edge that identifies the unit on the network. The format for the IP address field is a 32-bit numeric address written as four numbers separated by periods (ddd.ddd.ddd.ddd). Each number, ddd, can be 0 to 255. In the server mode, 192.168.2.1 shall be used to access the controller.
Subnet Mask *	Internal network address assigned for identifying an internal network mask that the Pulsar Edge has been assigned to by a network administrator. The mask selectively includes or excludes certain equipment on a Host. The format for the Subnet Mask field is a 32-bit numeric address written as four numbers separated by periods (ddd.ddd.ddd.ddd). Each number, ddd, can be 0 to 255.
Default Router	This address is for the address of the Gateway or node on the
Gateway *	network that will serve as the entrance to another network for the Pulsar Edge. This address should be the address of the equipment or computer that routes the traffic from and to the Pulsar Edge to the outside network. It is generally the proxy server. The format for the Gateway address field is a 32-bit numeric address written as four numbers separated by periods (ddd.ddd.ddd.ddd). Each number, ddd, can be 0 to 255.
Domain NameDNS*	Address of the Domain Name Server that translates domain names into IP addresses. This field is of the format ddd.ddd.ddd.ddd.
Host Name	Network name assigned and configured for the Pulsar Edge since it acts as a repository for data and services such as e-mail, FTP, HTTP, etc that are accessed remotely by other equipment or users on the network.
Mail Host(Server)	The address for the computer or equipment within the network that will manage the Pulsar Edge e-mails. The format for the Gateway address field is a 32-bit numeric address written as four numbers separated by periods (ddd.ddd.ddd.ddd). Each number, ddd, can be 0 to 255. If configured as 0.0.0.0, the controller will use the hostname mail host.
Session Timeout	Configured time that the controller will hold a static network connection before disconnecting. This time is configurable between 0 and 45 minutes. A "0" is a non-timed connection. The factory default is 10 minutes.
Write Enabled	This field shows whether the port has been configured to allow Read/Write access or Read Only access. Read/Write access is available when the feature has been enabled.

* These fields are automatically assigned when using the DHCP server or Client mode of operation and are generally required when utilizing a Static IP address setting.

The controller provides configurable community strings for SNMP traps and Sets and Gets

Trap Community Strings	Individual IP addresses and description configurations for up to four public community string alarm traps are provided. Assignment of alarms to the appropriate community string is performed at the Settings Communication Alarm Notification link.
Set/Get Community Strings	IP addresses and descriptions for up to three Set/Get community strings are provided. Default community string descriptions are public, public-write, and private. Each string has the ability to be configured by an administrator to be write enabled or read only. The public-write and private have been defaulted with write capability.

HTTP

HTTP (hypertext transfer protocol) is the foundation protocol of the World Wide Web (www) and can be used in any client-server application involving hypertext. HTTP makes use of TCP (transmission control protocol) for client to server connection and IP (internet protocol) for internetworking. The Pulsar Edge's standard HTTP protocol web pages provide integrated site information with an enhanced graphical user interface. The on-board HTTP web pages server is password protected for read/write privilege. Further access restrictions can be implemented using the software read/write disable capabilities. The Pulsar Edge has a configurable timeout for connections that remain idle more than a user-programmed time period. The best way to learn the web pages is to go through each tab and look at the features.

TELNET

Telnet provides remote log-on capability to a computer or server. The terminal to terminal connection with Telnet is based on a TCP connection for traffic between user and server. Once login is established; the Pulsar Edge will support this session until the “exit” command is received or the idle timeout limit is reached. A command line interface is used to view and configure the Pulsar Edge’s features and thresholds. Backup, restore, and upgrade procedures may also be performed.

SNMP

SNMP (simple network management protocol) is the most dominant network management standard. It allows communication and control via open standards host systems for centralized management of multiple plants. A number of vendors such as HP OpenView, IBM NetView, Lucent OneVision, and Sun Micro’s NetManager have adopted the standard for telecommunication and computer equipment network management. A standard MIB for the Pulsar Edge is available to be down loaded on the web at www.gecriticalpower.com . Up to four SNMP alarm trap destinations can be programmed using the Network Settings link found in Settings Tab of the web pages.

Alarms then can be assigned under Alarm Notification also found in the Settings tab of the web pages. SNMP is more fully described in the Appendix.

SMTP

SMTP (simple mail transfer protocol) provides a basic electronic email facility. It provides a mechanism for transferring messages among separate hosts and browser applications. The protocol is used in Gateway for sending alarm messages and alerts through email.

FTP

FTP (file transfer protocol) is used to send files from one system to another under user commands. The protocol is used with the Pulsar Edge for downloading files and upgrades through a TCP connection. Application software, default configuration file, and web pages are uploaded to the Pulsar Edge using FTP.

TL1

TL1 is the transaction language command interface that allows direct communication with a central monitoring system and is defined by Telcordia for various equipment. It allows communication and control via open standards host systems for centralized management of multiple plants. The protocol is typically used over a X.25 network for alarm reporting.

Email : Up to four separate email addresses can be assigned for alarm messages

Email		
Type	Description	Address
1	NORMAL <input type="text" value="Email Address 1"/>	<input type="text"/>
2	NORMAL <input type="text" value="Email Address 2"/>	<input type="text"/>
3	NORMAL <input type="text" value="Email Address 3"/>	<input type="text"/>
4	NORMAL <input type="text" value="Email Address 4"/>	<input type="text"/>

Port Configuration-Local/Modem Port

This page provides the ability to Enable or Disable Write access to the local port. The factory default setting is enabled. The baud rate, number of data bits, parity, number of stop bits, and flow control parameters for the port is also configurable. These parameters have been factory set to 9600, 8, none, 1, none, respectively.

This page also provides the ability to Enable or Disable Write access through an external Modem connection. The factory default setting is enabled. The number of data bits, parity, number of stop bits, and flow control parameters for the port is also configurable. Note: the initialization string of the external MODEM must be set in the controller. Factory default for the string is AT&FEV&C1S0=0H. This string can be modified by utilizing EasyView or T1.317 commands through a local terminal connection. The number of rings to be detected by the modem before it answers (Rings to Answer) can be set from 1 to 9. The factory default setting is 1. Following is a sample screen.

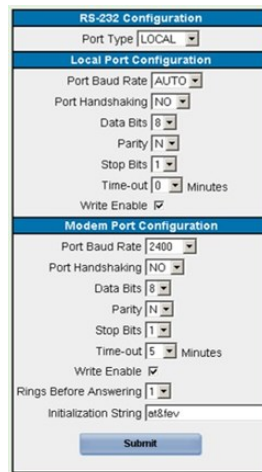

The screenshot shows the 'RS-232 Configuration' page. It is divided into three sections: 'RS-232 Configuration', 'Local Port Configuration', and 'Modem Port Configuration'.
 - **RS-232 Configuration:** Port Type is set to 'LOCAL'.
 - **Local Port Configuration:** Port Baud Rate is 'AUTO', Port Handshaking is 'NO', Data Bits is '8', Parity is 'N', Stop Bits is '1', Time-out is '0' Minutes, and Write Enable is checked.
 - **Modem Port Configuration:** Port Baud Rate is '2400', Port Handshaking is 'NO', Data Bits is '8', Parity is 'N', Stop Bits is '1', Time-out is '5' Minutes, Write Enable is checked, Rings Before Answering is '1', and the Initialization String is 'at&fev'.
 A 'Submit' button is located at the bottom of the page.

Alarm Call Out

This page provides additional alarm call out support when using a Modem. Following is a sample screen.



The screenshot shows the 'Alarm Call Out' configuration page. It includes:
 - Nag Interval: 15 minutes.
 - Select a phone number: P1, P2, P3, P4, CA1.
 - Description: Cell-Out Number 1.
 - Baud: 2400, Data bits: 8, Parity: none, Stop bits: 1.
 - Pager ID, Message, and Delay (minutes) fields.
 - Alarm and Severity Relay sections, both with 'No Call-Out Response' and 'Unconfigured Alarm Destination' set to 'WRN'.
 A 'Submit' button is at the bottom.

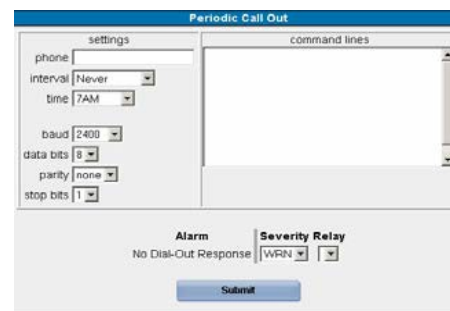

The screenshot shows the 'Periodic Call Out' configuration page. It includes:
 - Settings section: phone, interval (Never), time (7AM), baud (2400), data bits (8), parity (none), stop bits (1).
 - Command lines section: a text area for entering commands.
 - Alarm and Severity Relay sections, both with 'No Dial-Out Response' and 'WRN' selected.
 A 'Submit' button is at the bottom.

Alarm Notification

This page provides the ability to assign specific alarms to specific SNMP trap location, email addresses, alarm relays (if present), and phone numbers. Clicking on a particular position will allow the configuration. Note the SNMP trap tests use the SNMP assignments from this screen. Following is a sample screen.

Notify Settings										
	ID	Sev.	Relay	LED	EMAIL	SNMP	PHONE	Delay		
System Alarms										
High Ambient Temperature	AMTH1	MIN			1 2 3 4	1 2 3 4	1 2 3 4 0 R N	0s		
Low Ambient Temperature	AMTL1	MIN			1 2 3 4	1 2 3 4	1 2 3 4 0 R N	0s		
Auxiliary Major	AMJ1	MAJ			1 2 3 4	1 2 3 4	1 2 3 4 0 R N	0s		
Alarm Test Active	ATA1	RO			1 2 3 4	1 2 3 4	1 2 3 4 0 R N	0s		
Alarm Test Aborted	ATB1	RO			1 2 3 4	1 2 3 4	1 2 3 4 0 R N	0s		
Real Time Clock Battery Low	BBL1	MIN			1 2 3 4	1 2 3 4	1 2 3 4 0 R N	0s		
Configuration Changed	CCH1	RO			1 2 3 4	1 2 3 4	1 2 3 4 0 R N	0s		
Clock Changed	CLC1	RO			1 2 3 4	1 2 3 4	1 2 3 4 0 R N	0s		
ID Conflict	DID1	MAJ			1 2 3 4	1 2 3 4	1 2 3 4 0 R N	0s		
Emergency Power Off	EPO1	MAJ			1 2 3 4	1 2 3 4	1 2 3 4 0 R N	0s		
Excessive Login Attempts	EXL1	WRN			1 2 3 4	1 2 3 4	1 2 3 4 0 R N	0s		
External Fuse Major	FAJ1	MAJ			1 2 3 4	1 2 3 4	1 2 3 4 0 R N	0s		
External Fuse Minor	FAN1	MIN			1 2 3 4	1 2 3 4	1 2 3 4 0 R N	0s		
History Cleared	HCL1	RO			1 2 3 4	1 2 3 4	1 2 3 4 0 R N	0s		
Imminent Low V Shutdown	ISD1	MAJ			1 2 3 4	1 2 3 4	1 2 3 4 0 R N	0s		
Password At Default	PFD1	RO			1 2 3 4	1 2 3 4	1 2 3 4 0 R N	0s		
Processor Halt	PHT1	RO			1 2 3 4	1 2 3 4	1 2 3 4 0 R N	0s		
Self Test Failed	STF1	MIN			1 2 3 4	1 2 3 4	1 2 3 4 0 R N	0s		
Sense/Control Fuse	VSF1	MIN			1 2 3 4	1 2 3 4	1 2 3 4 0 R N	0s		
ID Not Configured	ZID1	MAJ			1 2 3 4	1 2 3 4	1 2 3 4 0 R N	0s		
Reserve Alarms										
Battery On Discharge	BDA1	MAJ	ALM		1 2 3 4	1 2 3 4	1 2 3 4 0 R N	0s		
Check Battery	BFA1	MIN			1 2 3 4	1 2 3 4	1 2 3 4 0 R N	0s		
Very High Battery Temperature	BT VH1	MAJ			1 2 3 4	1 2 3 4	1 2 3 4 0 R N	0s		
High Battery Temperature	BTHA1	MIN			1 2 3 4	1 2 3 4	1 2 3 4 0 R N	0s		
Low Battery Temperature	BTLA1	MIN			1 2 3 4	1 2 3 4	1 2 3 4 0 R N	0s		
Very Low Battery Temperature	BT VL1	MAJ			1 2 3 4	1 2 3 4	1 2 3 4 0 R N	0s		
Open String	OSA1	MAJ			1 2 3 4	1 2 3 4	1 2 3 4 0 R N	0s		
Reserve Time Low	RTL1	RO			1 2 3 4	1 2 3 4	1 2 3 4 0 R N	0s		
Real Time Reserve Low	RRTL1	RO			1 2 3 4	1 2 3 4	1 2 3 4 0 R N	0s		
Battery Voltage Imbalance	SCD1	MIN			1 2 3 4	1 2 3 4	1 2 3 4 0 R N	0s		
Thermal Probe Failure	TPA1	MIN			1 2 3 4	1 2 3 4	1 2 3 4 0 R N	0s		
Thermal Probe Fail Safe	PFS1	MAJ			1 2 3 4	1 2 3 4	1 2 3 4 0 R N	0s		
Very Low Voltage	VLA1	MAJ	ALM		1 2 3 4	1 2 3 4	1 2 3 4 0 R N	0s		
Voltage Channel Failure	VMF1	MIN			1 2 3 4	1 2 3 4	1 2 3 4 0 R N	0s		
Battery Test Active	BTA1	RO			1 2 3 4	1 2 3 4	1 2 3 4 0 R N	0s		
Voltage Duplicate ID	MDP1	MAJ			1 2 3 4	1 2 3 4	1 2 3 4 0 R N	0s		
Voltage ID Not Configured	MZD1	MAJ			1 2 3 4	1 2 3 4	1 2 3 4 0 R N	0s		
Power Alarms										
AC Fail	ACF1	MIN			1 2 3 4	1 2 3 4	1 2 3 4 0 R N	0s		
Rectifier Current Limit	CLM1	RO			1 2 3 4	1 2 3 4	1 2 3 4 0 R N	0s		
High Voltage	HFV1	MIN			1 2 3 4	1 2 3 4	1 2 3 4 0 R N	0s		
Very High Voltage	HVA1	MAJ			1 2 3 4	1 2 3 4	1 2 3 4 0 R N	0s		
Multiple AC Fail	MACF1	MAJ			1 2 3 4	1 2 3 4	1 2 3 4 0 R N	0s		
Manual Off	MAN1	MIN			1 2 3 4	1 2 3 4	1 2 3 4 0 R N	0s		
Multiple Manual Off	MMAN1	MAJ			1 2 3 4	1 2 3 4	1 2 3 4 0 R N	0s		
Multiple Rectifier Fail	MFA1	MAJ			1 2 3 4	1 2 3 4	1 2 3 4 0 R N	0s		

UDE Notification

The Pulsar Edge has the ability to create customized alarm events through a programming feature called User Define Events. Events that are programmed have the same configurable alarm parameters that show up and can be modified under the UDE Notification link. A sample screen is below.

Notify Settings for User Defined Events										
	ID	Sev.	Relay	LED	EMAIL	SNMP	PHONE	Delay		
User Defined Alarms					1 2 3 4	1 2 3 4	1 2 3 4 0 R N	0s		
User Event 1	U0001	RO			1 2 3 4	1 2 3 4	1 2 3 4 0 R N	0s		

Alarm Cut Off

This feature is reserved for a future implementation of an audible alarm.

TL1

The Pulsar Edge has the ability to interface using the TL1 protocol. This screen allows the respective TL1 variables to be configured. A sample screen is below

TL1

Activate-User Enable
 CTS Connect Detection
 DSR Connect Detection

Alarm Source	Condition	Aid	Type	SA	Reporting
AC Fail	Condition Description	AID1	Condition Type	<input checked="" type="checkbox"/> EQUIPMENT	<input type="button" value="Edit"/> <input type="button" value="Del"/>

Select an alarm to create a new TL1 message source:

Programming

The Pulsar Edge has provides the ability to configure its alarms inputs as well as create user defined events and derived channels. The inputs available depend on the shelf configuration that the controller resides as well as the exact Pulsar Edge controller configuration. Thus, not all systems have the same available inputs. The controller’s web pages are configured to present the input and outputs that are available for the specific controller and system it is configured. Following show some examples of the Auxiliary input differences.

Auxiliary Alarm Inputs

This page provides the ability to configure the specific controller inputs. Clicking to Edit associated alarm button, assign specific alarms to specific SNMP trap location, email addresses, alarm relays (if present), and phone numbers. Following is a sample screen of a CP841A_9COR.

Controller Auxiliary Inputs

REF	Description	Input Assignment	Alarm Criteria *	Click to Edit Assoc. Alarm
(#0001)	Input 0	FAJ1	CLOSED	<input type="button" value="Edit"/>
J2.2 (#0002)	Input 1	OSA1	CLOSED	<input type="button" value="Edit"/>
J2.3 (#0003)	Input 2	ALX2	CLOSED	<input type="button" value="Edit"/>
J2.4 (#0004)	Input 3	ALX2	CLOSED	<input type="button" value="Edit"/>
J2.5 (#0005)	Input 4	ALX3	OPEN	<input type="button" value="Edit"/>
J1.1 (#0006)	Input 5	ALX4	CLOSED	<input type="button" value="Edit"/>
J1.2 (#0007)	Input 6	ALX5	CLOSED	<input type="button" value="Edit"/>
J1.3 (#0008)	Input 7		CLOSED	<input type="button" value="Edit"/>
J1.4 (#0009)	Input 8	ALX7	CLOSED	<input type="button" value="Edit"/>
J1.5 (#0010)	Input 9	ALX8	CLOSED	<input type="button" value="Edit"/>
J1.7 (#0011)	Input 10	ALX9	CLOSED	<input type="button" value="Edit"/>
J1.8 (#0012)	Input 11	ALX10	CLOSED	<input type="button" value="Edit"/>
J1.9 (#0013)	Input 12	ALX11	CLOSED	<input type="button" value="Edit"/>
J1.10 (#0014)	Input 13	ALX6	CLOSED	<input type="button" value="Edit"/>

*** Alarm Criteria / Polarity**

- The Aux power major is a contact closure to the non-grounded side of the dc bus [+24V/-48V]
- The PBT(Group Standby/TR) [CGTR] is a dedicated input for a contact closure to pin 9.
- The CPD is an input with a dedicated input for a contact closure to pin 10.

Input Assignment
(This space used when editing an input.)

Controller Auxiliary Inputs

REF	Signal Description	Alarm Assignment	Alarm Criteria *	Click to Edit Assoc. Alarm
Internal (#001)	Fuse Alarm Major	FAJ1	CLOSED	<input type="button" value="Edit"/>
J2.1 (#0006)	SPD Fail	ALX3	CLOSED	<input type="button" value="Edit"/>
J2.2 (#0007)	Open String	OSA1	CLOSED	<input type="button" value="Edit"/>
J2.3 (#0008)	Auxiliary Major Alarm	AMJ1	CLOSED	<input type="button" value="Edit"/>
J2.4 (#0009)	Air Conditioner Fail	ALX1	CLOSED	<input type="button" value="Edit"/>
J2.5 (#0010)	Door Open	ALX2	CLOSED	<input type="button" value="Edit"/>
J1.1 (#0011)	PBT/TR	ALX2	CLOSED	<input type="button" value="Edit"/>
J1.2 (#0012)	High External Ambient	ALX4	CLOSED	<input type="button" value="Edit"/>
J1.7 (#0013)	Customer Alarm 1	ALX8	CLOSED	<input type="button" value="Edit"/>

*** Alarm Criteria / Polarity**

- Input (#001) is dedicated to internal distribution alarm and provides a contact closure to the non-grounded side of the dc bus [-48V]
- Inputs to J2 are contact Closures or Opens to the non-grounded side of the dc bus [-48V]
- Inputs to J1 are "Dry", no voltage, contact Closures or Opens to a common return on J1.6.

Alarm Assignment
(This space used when editing an input.)

Following is a sample screen of a CP841A_3C3R

User Defined Events

This page provides the ability to create specific events using the T1.317 variables and the basic mathematical operators to create a User Defined Event by creating a specific program line. Once the event is created it has the very similar configurable attributes as other basic controller alarms. Following is a sample screen.

User Defined Events						
UDE	Description	Severity	Program Line	Minimum Duration	Latched	Contact Closure
1	User Event 1	RO		0	<input type="checkbox"/>	NONE NONE
<input type="button" value="Add New Event"/>						

Program Line	Sets the condition upon which the alarm will be asserted. The program line can have total of 40 characters having a total of 12 operators and operands
Logical operators are:	& AND, OR, ^ XOR and ! NOT
Binary mathematical operators are:	+ plus, - minus, * times and / divide
Unitary mathematical Operators are	+ Positive, - Negative
Comparator operators are:	= equal, < less than and > greater than. Parentheses are accepted

Installation Tab

This section provides the minimum configuration required to get a site configured. It includes the Site ID (up to 12 characters), Site Description (Up to 55 characters), Date, Time, and the installed battery type. The “J- Code” for the shelf is used by the controller to define the web page view of the auxiliary inputs and generally should not be edited when the product is shipped from the factory. A high level summary of the basic installed equipment is also provided.

Enable Walk-In	Standard telecom system applications generally will have system level rectifier Walk-In Enabled. There is a small subset of applications, generally not involving batteries that do not desire the typical telecom system rectifier walk-in characteristics. When Walk-In is not Enabled, the controller will issue a command to the rectifiers to disable walk-in. Once the command has been sent, AC input power to each rectifier must be cycled in order for their new mode of operation to become effective. Presently only Compact Power Line (CP) rectifiers have this capability. The overwhelming majority of systems will use the walk-in mode of operation. When in doubt, contact your local technical field support. The factory default for this feature is Enabled (checked).
----------------	--



ID Override	<p>Standard systems from the factory are designed such that rectifiers report their individual shelf and slot locations to the controller in the form of an ID (Gxy). “x” is the shelf ID and “y” is the slot position in that shelf. There are some custom systems that exceed the normal ID addressing scheme. To work with these systems the typical ID addressing scheme must be overridden. Checking this box enables that feature. Shelf and slot positional information is lost when operating in this mode. The vast majority of systems will not use this mode of operation. When in doubt, contact your local technical field support. The factory default for this feature is disabled (not checked).</p>
-------------	--

Software Tab

This section provides access to save a site’s configuration, restore a site configuration, and the ability to load or upgrade various controller software modules through the web page interface.

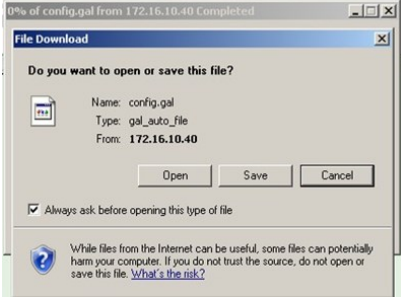
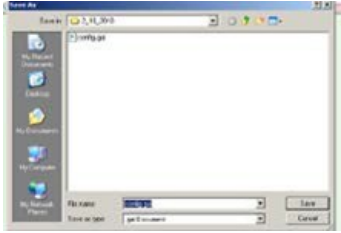

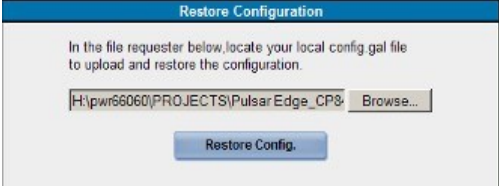
Save Configuration	<p>Clicking on this link provides a self-explanatory path to perform a backup of the controller’s configuration to a “config.gal” file. The intention of this file is to store a sites entire configuration. This file then can be used to restore the site in the event of a failure or configuration reset. The “config.gal” file is a text editable file. Items can be eliminated or changed to allow other sites to be restored to a similar condition. The “.gal” extension must be preserved. Future release of the controller software will allow the prefix of the file to be variable and loaded through the web pages.</p> <div style="display: flex; justify-content: space-around;">   </div>
--------------------	--

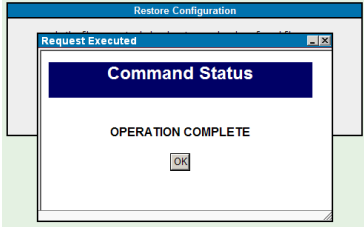
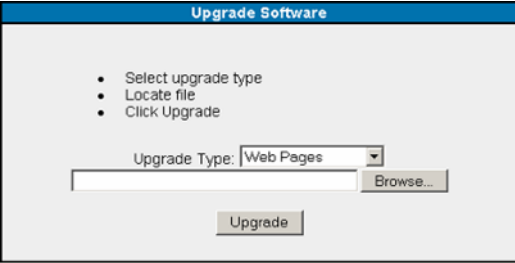
<p>Restore Configuration</p>	<p>Clicking on this link provides a means to locate the “config.gal” file and restore a system controller using a known configuration file. Updates can also be made through a configuration file that has been edited. A “please wait” will be presented during the Uploading process and removed when the operation is complete.</p>   
<p>Upgrade Software</p>	<p>Clicking on this link provides a path to upgrade the various software components in the controller. These include: Web pages, language file, application code, and custom factory defaults. Upgrading software goes through similar steps as restoring a configuration described above.</p> 

Controller Peripherals

One-Wire Peripheral Devices

QS873A Voltage/Thermal Probes

The QS873A Voltage/Thermal Probes (VT-Probes) are used to measure battery temperatures for slope thermal compensation, and to provide mid-string voltages to the ES771 for battery voltage imbalance detection. Each of these weatherized assemblies monitor their respective contact temperature and converts the measurements into serial data which is then read by the system controller using Maxim’s industry standard 1-Wire® bus. Several QS873A probes can be connected in a serial fashion since the data is received through digital means. The Pulsar Edge system controller can handle up to 16 VTprobes . This allows multiple strings and or multiple batteries within a string to be monitored for temperature. As mentioned, these probes are required for the battery string voltage imbalance feature since they route the mid-string voltage to the system controller via the ES771A remote mid-string voltage monitoring modules. All probes are provided with a PTC device to protect against accidental short circuit during voltage measurements.

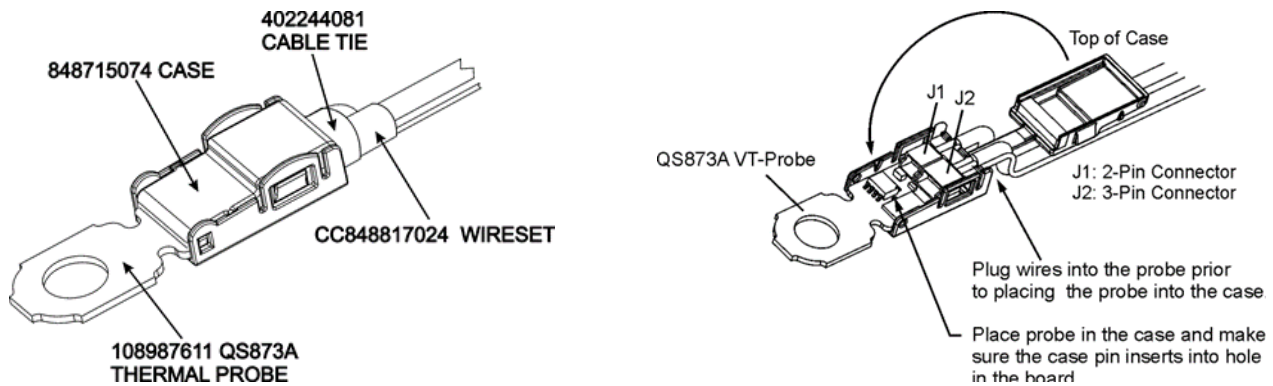

Figure 17 QS873A Voltage/Thermal Probe (VT-Probe)

Following is a brief description of the interfaces on the QS873A VT-Probe depicted above.

J2

3-position connector connects the VT-Probe to the 1-Wire interface through cable 848719795. It may also connect directly to the ES771A with (CC848791517, 2.5') or (848719829, 10') or other VT-Probes in daisy chain fashion using either the (848719803, 5') or the (848719811, 10') cable.

J1

2-position connector serves to connect the VT-Probe to J2 on other VT-Probes in a daisy-chain fashion described above.

Application

QS873 VT Probes can be used with or without mid-string voltage monitoring. Only one probe is required to allow the battery slope thermal compensation function to be utilized. Additional probes for individual battery or multiple string monitoring can be added as desired. The highest temperature measured from all the probes is utilized by the controller. Although many systems come with the probes factory installed, probes can be added or replaced in the field. The following figure depicts monitoring all batteries in a single string without the use mid-string voltage monitors. Actual cables and connectivity may depend on true system connect

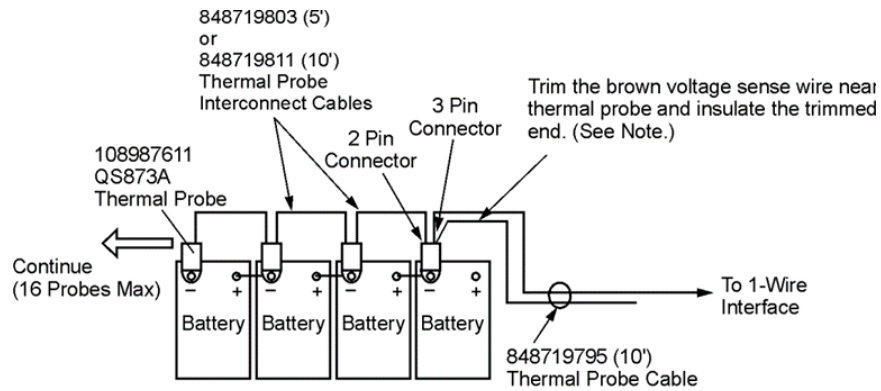

Note: 848719795, 848719803 and 848719811 come with a discrete brown wire for Battery Voltage Sense. When ES771A Modules are NOT used, trim and insulate this wire

Figure 17 QS873A Voltage/Thermal Probe (VT-Probe)

Following are basic steps when installing the temperature probes for Thermal Compensation without Voltage Monitoring.

Step	Action
1	The QS873A weatherized VT-Probe is provided with 2-pin and 3-pin receptacles and a 1/4-inch ring terminal. Insert the RJ-45 end of the 848719795 wire set into the P5- SYS AUX PORT on the controller
2	Using voltage monitoring now or in the future? No - Cut the brown voltage sense wire on the 848719795 at the 3-pin connector. Yes - Insulate the end of the wire and secure it in the system for future use.
3	Insert the 3-pin connector end of the cable into the receptacle on the VT-Probe closest to the controller.
4	Snap the cover closed on the VT-probe.

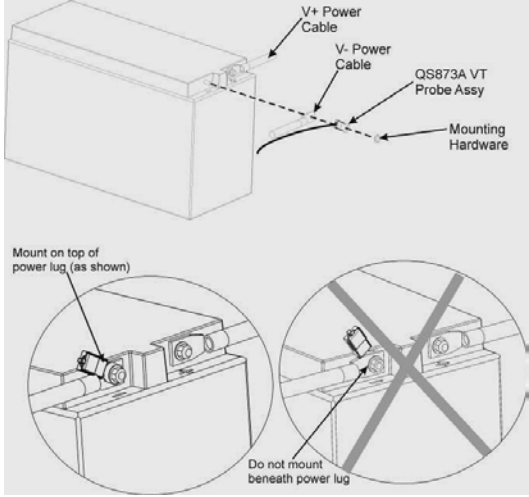
Step	Action
5	<p>Place the first probe to the negative battery post as shown in the figure.</p> 
6	<p>The controller automatically recognizes the VT-probes. The number of registered temperature probes and the highest battery temperature monitored may be checked from the front panel by scrolling down the menu at Menu → Status → Batteries. The fields are “Num Temp Probes ()” and Highest Temp () where () contains the number of devices communicating in the system as well as the highest battery temperature.</p>
7	<p>Connect either the 848719803 (5-ft) or the 848719811 (10-ft) cable to the 2-position receptacle of the first probe and to the 3-position receptacle of another probe. Verify the number of probes (2) registered with the controller with command: Menu → Status → Batteries NUM TEMP PROBES (2)</p>
8	<p>Repeat Step 7 until all probes are installed.</p>
9	<p>The controller is now able to make thermal measurements in performing Slope Thermal Compensation (STC). To enable or verify that STC is active go to Menu → Configuration → Batteries → Battery Temp Management and select TEMP COMP and verify that the feature Temperature Comp is Enabled. If not, configure and save it appropriately. Additional parameters associated with slope thermal compensation may be set on the controller to customize this feature.</p>

ES771A Remote Mid-String Voltage Monitor Module

The ES771A remote mid-string voltage monitoring module is used to measure the mid-string voltages of up to three strings of batteries. This unit utilizes an appropriate QS873A VT-Probe connection to obtain the voltage for measurement. It then serially transmits the appropriate information to the system controller which performs the voltage imbalance detection feature. It also serves as interface that transmits the thermal data from the VT-Probes for slope-thermal compensation and other battery management features. As with the QS873A VT probes, ES771A units also utilize Maxim’s industry standard 1-Wire® bus. Thus, multiple ES771A devices can be used and placed in a daisy chain fashion along with the QS873A VT probes. The number of Mid-string voltage modules actively hooked to batteries and being monitored by the system controller to batteries is displayed under Batteries in the Status menu. Note: VT-Probes must be connected to the batteries in order for the ES771 to be recognized.

The Pulsar Edge can monitor up to six ES771A modules. Each ES771A module is individually addressed so that specific mid-string voltages can be displayed and identified. A seven-position rotary ID switch located on the unit must be set to a unique address number otherwise an ID conflict alarm will be generated. Units are shipped out of the factory with a default ID setting of “one”. If additional units are to be in the system the ID must be reconfigured. Note: there are systems that are shipped with ES771A units installed and with proper configuration.

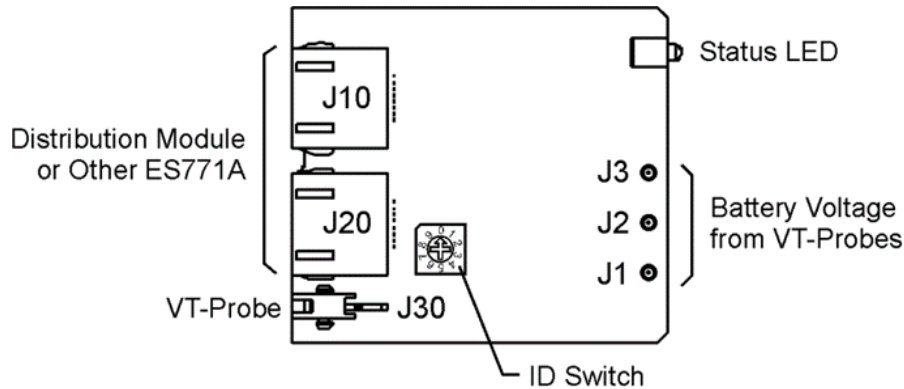

Figure 19 ES771A Remote Voltage Monitor Module

Following is a brief description of the interfaces on the QS873A VT-Probe depicted above.

J10, J20

RJ-45 receptacles that connect the ES771A to other ES771As or the 1-Wire interface port of the controller or system provided 1-wire interface. Typical cables utilized are the (CC848791500, 4”) or (848652947, 10’) cable.

J30

Connects the ES771A to the first QS873A VT-Probes using either the (CC848791517, 2.5’), the (CC848797290, 6’) or the (848719829, 10’) cables.

J1, J2, J3

Snap-fit connectors for the mid-string voltage signal wire (Brown) from the VT-Probes.

ID Switch

A seven-position rotary ID switch is used by the Pulsar Edge to uniquely address each ES771A in the system. A setting of “0” produces an invalid ID alarm. Valid ID settings are from 1 through 6. Units shipped from the factory have a factory default ID setting of “one”.

Status LED

The module illuminates its green LED when plugged into the 1-wire network and with the VT-probe attached to negative battery terminal of the mid-string voltage. The LED will illuminate red when the controller determines that one or more of the strings from the unit has exceeded the Mid-String Voltage threshold and time considerations.

Application with QS873 VT Probes

ES771As require the use of QS873 VT Probes to activate the mid-string voltage monitoring feature in the Pulsar Edge. One VT probe is required for each mid-string voltage being monitored. Additional VT probes can be added for individual battery temperature measurement. The highest temperature measured from all installed VT probes is utilized by the controller for slope thermal compensation. Many factory built systems come with the ES771A modules and QS873A VT probes installed. Additional ES771A modules can be added or replaced in the field as necessary. The following figure depicts a typical configuration where four battery strings are monitored with a minimum number of VT probes. The middle battery in each string is used when both the voltage imbalance and thermal compensation features are desired. This is one of many configurations using the ES771A for monitoring. Consult technical field support if questions or concern arise.

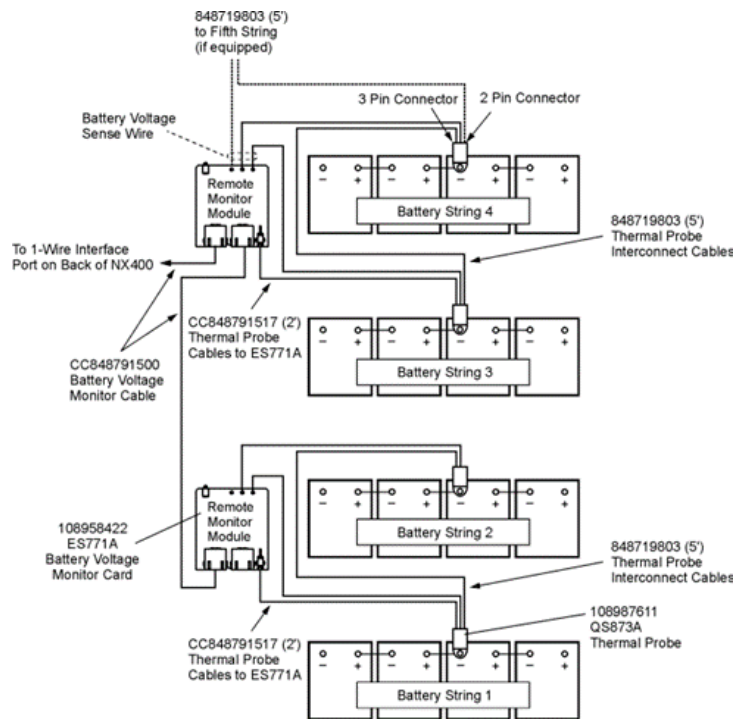

Figure 20 Four-String System Monitored For Imbalance

Step	Action
1	Insert one RJ-45 end of the 848652947 wire set into the P5-SYS AUX PORT on the controller and the other end to the first ES771A Remote Voltage Monitor module.
2	Follow the steps for installing a probe described in the previous section to attach a VT probe to the negative post located at the center of the string as depicted in Figure_20. Do not cut the brown wire.
3	Dress and attach the snap fit connector on the brown wire to the appropriate snap fit pin on the ES771A (J1-J3). Note: exercise care when attaching the battery voltage sense wire onto the J1, J2, and J3 pins of the ES771A pins. These push-on clips can be deformed if excessive force at an incorrect angle of insertion resulting in a non-optimum connection. The contact should not be bent more than 10 degrees.

Step	Action
4	Verify that the controller automatically registers the number of ES771A modules (1) At the front panel location: Menu → Status → Batteries → Num Mid-String V Note: Modules will only be recognized when there is actual potential applied Through the VT probe to the ES771 module.
5	Connect another ES771A to the controller by connecting an additional 84-8652947 wire set from the first module to the RJ45 receptacle on the second module. Verify the number of modules (2) registered with the controller with command: Menu → Status → Batteries → Num Mid-String V
6	Repeat Step 5 until all modules are installed. Verify that all probes are also Automatically detected by the controller at the front panel at: Menu → Status → Batteries → Num Temp Probes
7	If the LEDs on the module (s) are not illuminated green on or are red or if the number of registered modules does not agree with the number used: Check Integrity of all cable connections
8	Issue the Clear Events command: Menu → Control/Operations → Clear Events. If the LEDs are still not lit green or if the number of registered modules still does not agree, call your local field representative.

The system is now set to monitor both voltage and temperatures to support the batter string voltage imbalance and slope thermal compensation features. Figure 21 depicts a reserve system where every battery in the string being monitored for temperature. Again, the highest temperature measured will be used for battery thermal management. Only one temperature probe is required for thermal compensation features.

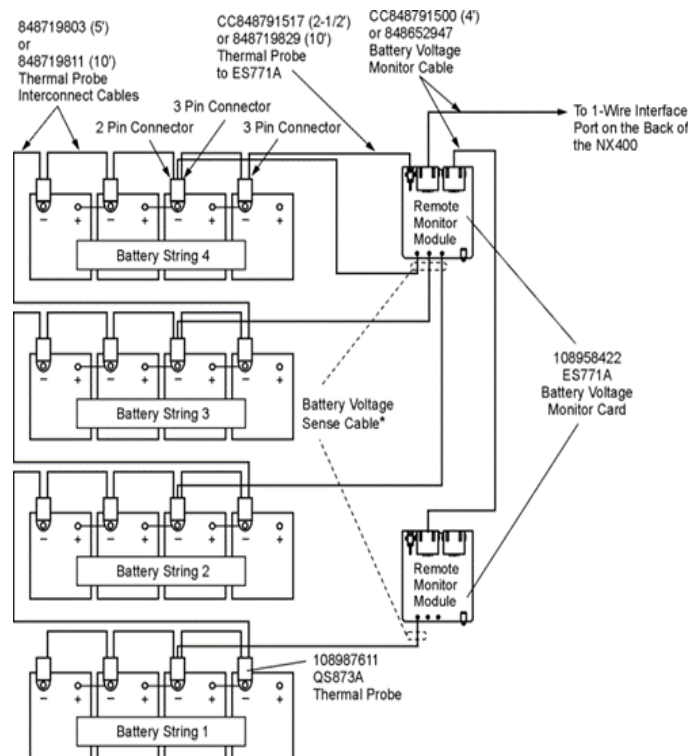

Figure 21 Same System Monitored For Imbalance with VT Probe on Every Battery

Following is a summary of the parts utilized in the 1-Wire management system. Consult quick start guides for the latest information.

Probe And Cable Descriptions	Comcode
QS873A battery thermal probe	108987611
QS873A_K4 battery thermal probe	CC109142980
10-ft Probe to Infinity NE interconnect	848719795
5-ft Probe to probe interconnect	848719803
10-ft Probe to probe interconnect	848719811
ES771A Voltage Monitoring Module	108958422
2.5-ft Probe to ES771A interconnect	CC848791517
10-ft Probe to ES771A interconnect	848719829
4-ft ES771A to ES771A/Infinity NE interconnect	CC848791500
10-ft ES771A to ES771A/Infinity NE interconnect	848652947

NE872A Remote Distribution Monitor and Control Module

Overview

Although the Pulsar Edge has the ability to directly control and manage a single LVD contactor with additional hardware. It can manage additional LVDs and distributions through the use of remote distribution monitor and control modules like the NE872. The NE872A (CC109124780) allows the Pulsar Edge controller to manage various distributions through serial communications in rectifier and converter based systems. The system controller will communicate over the GP RS485 bus to the NE872A and monitor associated alarms for open load or battery protectors, measure a single shunt configured as a load or battery shunt, monitor the DC bus voltage for back-up LVD functionality, and control and monitor a single load or battery latching LVD contactor. The board allows addressing for up to eight NE872As being installed in a system. Figure 22 shows the connections and interfaces for the NE872A.

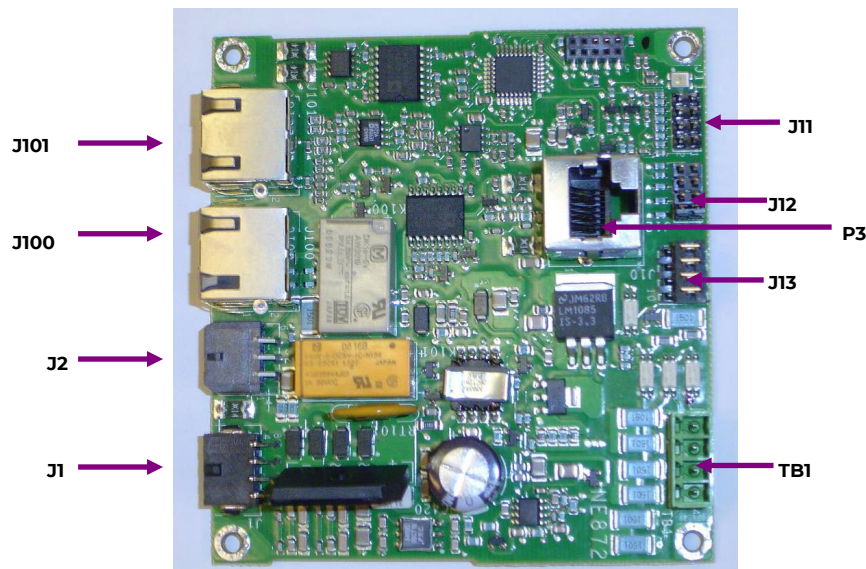

Figure 22 NE872A Remote Distribution Module

Features

The NE872A module has the following features:

- **Status LED:** Tri-colored LED that illuminates according to following conditions

LEDs (★ = On)			
Green	Amber	Red	Condition
★			Normal
	★		Minor Alarm
		★	Major Alarm
		Flashing	Communication Loss with Controller
Flash (5s)		★	Manual Reconnect Command Accepting

In addition, the following conditions will illuminate the LEDs as described below. This assumes the external disconnect switch is used to open and close the battery charging path to the batteries.

Alarm Inputs: The NE872A can be referenced to either Vbus (-) or Vbus(+) so it can be used in both positive and

Tri-Color LVD Status			
Condition	Red	Green	Amber
Contactors Closed (Normal)		X	
Contactors Open (Normal) (Flash between -Each~1/2 sec on)	X	X	
Contactors Open Due To Remote LVD (Flash between - Each~1/2 sec on)	X		X
ID not configured			Flashing
Alarm Inputs <ul style="list-style-type: none"> • Open String • FAJ alarms 			X
Fault Alarms <ul style="list-style-type: none"> • Board Fault • Contactor FAIL 	X		
Lamp Test operation activated (10 second operation)	Red 3 seconds On, Green 3 seconds On, Amber 3 seconds On, All off for 1 second		

negative grounded systems. All alarm or control inputs are either alarmed on an open or a closure to VBus(-) or provide its own signal return as described below:

- Remote LVD Open: The NE872 has the ability to accept a dry contact closure that will allow an external controller to force open the LVD independently from the system controller. The contactor will remain disconnected as long as the input is asserted. Upon de-asserting the input contactor closure, the NE872 will return the LVD to the a state dictated by the controller.
- Fuse Alarm Major: A contact closure to the non-grounded “Battery” side of the DC bus (- 48V/±24V) applied to this respective input, by default, produces an “Fuse Alarm Major” alarm by the controller.
- Open String: A contact closure to the non-grounded “Battery” side of the DC bus (-48V/±24V) applied to this respective input, by default, produces an “Open String” alarm by the controller.

External Shunt Monitoring Input: The NE872 has the ability to monitor a single shunt mounted in the grounded or non-grounded side of the DC bus in a $\pm 24V$ or $-48V$ power system. The shunt must have a 50mV rating. Its current rating as well as its assignment to load or battery is configured at the controller. Three leads are used to monitor the shunt: Shunt+, Shunt-, and Shuntref. Shunt+ is the most positive side of the shunt input voltage as defined during a battery discharge. Shunt- is the most negative side of the shunt input voltage as defined during a battery discharge. Shuntref is the reference lead which must be attached to the DC side of the bus in which the shunt resides to properly reference the circuitry.

Contactor Management: Controls and monitors one load or battery contactor. The contactor is of the magnetic latching type equipped with an auxiliary switch for status. The board is designed to drive both 24V and 48V rated contactors.

Reverse Battery Protection: The NE872A will prevent the closure of the battery contactor when it senses batteries have been connected in reverse polarity. A Major alarm “Reversed Battery” is generated by the system controller. When a battery disconnect breaker is used to take battery strings off-line for servicing, care must be taken to ensure battery connections are correct at the disconnect switch.

Autonomous Backup LVD Function: The NE872 monitors the system bus voltage to provide a backup for the Low Voltage Disconnect (LVD) function. In the event of a loss of communication between the NE872A due to a failed or removed controller, communication cable disconnect, etc. the configured disconnect and reconnect values assigned to a particular LVD function at the controller are used along with the boards internal measurement capability to control the LVD. These disconnect and reconnect threshold values are sent from the controller to each respective QS871A upon establishing initial communication.

8-Position Jumper: 8-position jumper arrangement that uniquely identifies up to eight NE872 remote distribution monitor and control modules. Placing no jumper, ID position 0, is an invalid configuration. The Pulsar Edge can address up to eight unique NE872s. Note: factory ordered systems are generally pre- configured and will have the jumpers appropriately set. Jumpers are arranged as shown.



Figure 23 NE872A ID Jumper Settings

- 12-Position Jumper:** 12-position jumper arrangement that configures the NES872 operate in a positive or negative battery plant. The jumper is selected so that all polarity sensitive items are selected at once by configuring one header. Note: factory ordered systems are generally pre-configured and will have the jumpers appropriately set. The block jumper is arranged as shown.

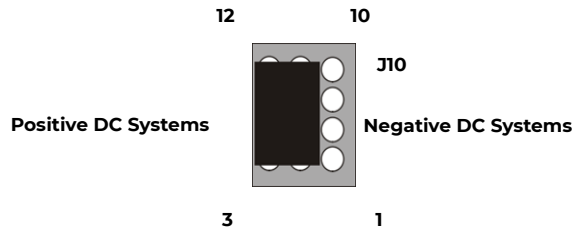

Connector Definitions

Figure 24 NE872A ID Jumper Settings

The NE872 module has six connectors used for board power, measurement, alarm inputs and various serial communications.

J1	Provides the connections to external distribution module's bus voltage and power, shunt inputs and reference, Fuse Alarm Major And Open String Inputs.
-----------	--

Pin #	Signal Name	Signal Description
1	FAJ	General purpose Fuse Alarm Major (FAJ) alarm input; Major alarm on closure to the non-grounded "Battery" side of the DC bus (- 48V/±24V). Optional connection at terminal block TB1.
2	NC	
3	SHREF	Shunt Reference signal to be placed in the DC potential of which The shunt resides to reference the shunt measurement
4	SHUNT+	Positive Battery Shunt input signal whose signal polarity is defined By the voltage on the shunt during battery discharge.
5	OS	Open String (OS) alarm input for external battery disconnect switch; Alarms on closure to the non-grounded "Battery" side of the DC bus (-48V/±24V). Optional connection at terminal block TB1.
6	NE_CM	Infinity NE Common or Discharge Ground (DG) connection used for power and voltage monitoring. Connection made to NE common in the Infinity system.
7	DB	Discharge Battery (BAT) power input connected to the Non- Grounded side of the DC bus. Also used as sense voltage for backup monitoring.
8	SHUNT-	Negative Battery Shunt input signal whose signal polarity is defined by the voltage on the shunt during battery discharge

J2	Provides the contactor management interface for control and LVD status.
-----------	---

Pin #	Signal Name	Signal Description
1	LVD_COILA	Low Voltage Disconnect Coil Voltage A. "A" positive with respect to "B" to close contactor. Signal connected to one side of contactor coil.
2	LVD_C	Common of contactor status indicator. Connect signal to Common of the micro-switch of contactor. Return reference for LVD auxiliary alarm status detection.
3	LVD_NO	Normally Open contactor status monitor indicator. Closed to LVD_C when contactor is closed. Connect signal to NO pin of micro-switch of contactor.
4	LVD_COILB	Low Voltage Disconnect Coil Voltage B. "B" positive with respect to "A" to open contactor. Signal connected to other side of contactor coil.
5	BATT_SNS	Reserve Battery Sense Voltage input signal. Battery bus voltage used for reverse battery detection. Connection made to battery side of the battery contactor. Signal connection must not be used for Load contactors.
6	LVD_NC	Normally Closed contactor status monitor. Closed to LVD_C when contactor is open. Connect signal to NC pin of micro- switch of Contactor.

TB1	Terminal Block connection that provides field access to Fuse Alarm Major, Open String, and the Remote LVD input.
------------	--

Pin #	Signal Name	Signal Description
1	Remote LVD Return	Protective (PTC or resistive) return to NE common for External Remote LVD contact closure input signal.
2	Remote LVD	External contact closure for remote disconnecting attached LVD; Disconnects LVD on a dry contact closure to Remote LVD Return when feature is enabled.
3	FAJ	General purpose Fuse Alarm Major (FAJ) alarm input; Major alarm on closure to the non-grounded "Battery" side of the DC bus (-48V/±24V). Optional connection at connector J1.
4	OS	Open String (OS) alarm input for external battery disconnect switch; Alarms on closure to the non-grounded "Battery" side of the DC bus

J100 and J101	Provides connectivity to the RS485 GP rectifier/converter bus as well as a pass through to the next RS485 connected device.
----------------------	---

Pin #	Signal Name	Signal Description
1	RS485+	B Inverting Driver Output / Inverting Receiver Input
2	RS485-	A Non-inverting Receiver Input/ Non-inverting Driver Output
3	RS485REF	RS485 Reference/return. Pass-through on this board.
4-8		No Connection

QS871A Remote Distribution Monitor and Control Module

Overview

Although the Pulsar Edge has the ability to directly control and manage a single LVD contactor without additional hardware. It can manage additional LVDs and distributions through the use of remote distribution monitor and control modules like the QS871. The QS871A (CC109103371) allows the Pulsar Edge controller to obtain distribution data and manage a non-latching contactor through serial communications over the RS485 bus. The system controller monitors alarms for open load or battery protectors, measures load or battery shunts, monitors the bus voltage, and controls and monitors a single load or battery LVD contactor. Figure 25 shows the connections and interfaces for the QS871A.

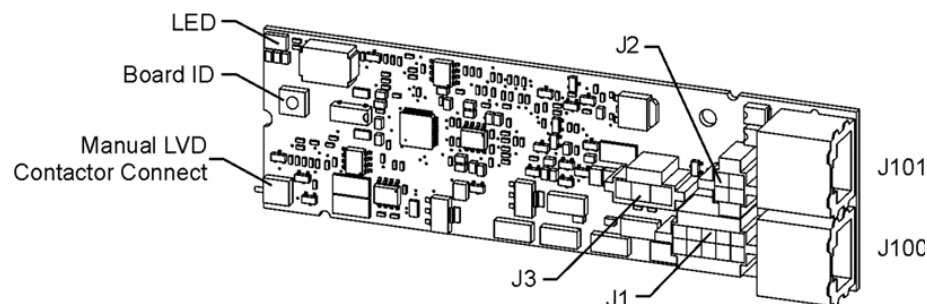

Figure 25 QS871A Remote Distribution Module

Features

The QS871A module has the following features:

- Status LED: This is a tri-colored LED and will illuminate accordingly for the conditions shown below.

LEDs (● = On)			
Green	Amber	Red	Condition
●			Normal
	●		Minor Alarm
		●	Major Alarm
		Flashing	Communication Loss with Controller
Flash (5s)		●	Manual Reconnect Command Accepting

In addition, the following alarms will be issued for the conditions noted. This assumes the external disconnect switch is used to open and close the battery charging path to the batteries.

Alarm Inputs: The QS871A is referenced to VBus(-), therefore, all alarm inputs are either alarmed on an open or a closure to VBus(-) as described below.

- One input closure to VBus(-) for Remote LVD Open (RO) from external source (J3 pins 1 and 2)
- One input to Fuse Input Major alarm upon closure to VBus(-), for distribution protector open alarms (J1 pin 7)
- One input to Open String alarm upon closure to VBus(-) for battery circuit breaker open alarms (J1 pin8)

Condition	Contactor Fail Alarm	Contactor Open Alarm	Open String Alarm	Edge LED	QS871 LED
Open Integral QS871A Disconnect Switch			X	RED	Blinking AMBER
Battery reconnected in reversepolarity	X	X		RED	RED
System started w/ reverse batterypolarity	X	X		RED	RED

Reverse Battery Protection: The QS871A will prevent the closure of the battery contactor when it senses batteries have been connected in reverse polarity. The QS871A will keep the contactor disconnected and generate an appropriate alarm. When a battery disconnect breaker is used to take battery strings off-line for servicing, care must be taken to ensure battery connections are correct at the disconnect switch.

Manual LVD Contactor Connect: This feature allows the Infinity NE or any other power system to resume powering the load after low voltage disconnect of batteries. Fully depleted battery strings can be replaced with fully charged strings. Once the strings have been installed, depressing the Manual LVD Contactor switch on the front of the QS871A module will result in the LVBD contactor closing. Continue to depress the switch until the Green LED stops flashing and displays a continuous green color. This indicates acceptance of the command and permanent closure of the contactor. Releasing the switch prior to the continuous green LED will result in the contactor opening and removing power to the load.

External Shunt Monitoring Input (J1 pins 4 and 5): The shunt must be in the VBus(-) leg to maintain proper reference with the QS871A module. These inputs are for the system controller to read battery or load currents. The polarity of the connections must be positive during battery discharge.

Contactor Management: Controls and monitors one load or battery non-latching contactor.

Autonomous Backup LVD Function: Monitor system bus voltage for backup LVD function (in case of loss of communication to the QS871As or failed or removed controller). The configured disconnect and reconnect values assigned to a particular LVD function are sent from the controller to each respective QS871A. In the advent of a controller failure the QS871As will utilize their individual voltage monitoring and these thresholds to disconnect and reconnect the contactor.

7-Position ID Switch: Rotary 8-position switch that uniquely identifies up to seven remote distribution monitor and control modules. ID position 0 is invalid. The Pulsar Edge can address up to eight unique distribution monitor and control modules.

Note: The majority of applications that utilize the QS871 utilize the QS871A. There are versions of the QS871 that are used in special applications where components have been removed because the feature was not required. These versions and the feature set are high-lighted below.

Feature	QS871A	QS871B	QS871C
Inputs			
• Open String input	X	X	X
• Fuse Alarm Major input	X		X
• Remote LVD Input	X		
• Auxiliary Alarm Input	X		
• Shelf ID Input		X	X
Misc			
• Status LED	X	X	X
Contactor Drive And Monitor			
• Momentary Forced Closed LVD switch	X		X
• Reverse Battery Detection feature	X		X
• Backup Contactor	X		X
• Disconnect/Reconnect Feature	X		X
Analog Monitoring			
• Shunt Monitoring Circuitry	X	X	X
• DC Bus Monitoring Circuitry	X	X	X
Connectors			
• Power/Shunt/OS/FAJ connector	X	X	X
• Shielded RJ-45 connectors	X		
• Remote LVD and Aux alarm connector	X		
• Contactor Control Connector	X		X

Connector Definitions

The QS871A module has five connectors: two RJ-45 connectors used for serial communication to ES773A VT-Probes, ES771A Remote Voltage Monitoring Modules, and the Pulsar Edge Pulsar Edge controller and three connectors for monitoring circuit breakers, contactors and shunts. The connectors are defined as follows.

J1	Provides the connections to external distribution module's bus voltage and power, shunt inputs and reference, Fuse Alarm Major And Open String Inputs, and shunt.
-----------	---

Pin #	Signal Name	Signal Description
1	VPWR-	VBUS(-) or BATT- Power. Power and board reference for QS871, connect to Non-Grounded side of the DC bus (-48V).
2	VPWR+	VBUS (+) Power and Positive Sense voltage for backup monitoring.
3	BATT-	Discharge Battery (BAT) input connected to the Non-Grounded side of the DC bus (-48V). Used as sense voltage for backup monitoring, reverse voltage detection, and force contactor closed.
4	SHUNT+	Positive Battery Shunt input signal whose signal polarity is defined by the voltage on the shunt during battery discharge.
5	SHUNT-	Negative Battery Shunt input signal whose signal polarity is defined by the voltage on the shunt during battery discharge

Pin #	Signal Name	Signal Description
6	OS	Open String (OS) alarm input for external battery disconnect switch; Alarms on closure to the non-grounded "Battery" side of the DC bus (-48V).
7	FAJ	General purpose Fuse Alarm Major (FAJ) alarm input; Major alarm on closure to the non-grounded "Battery" side of the DC bus (-48V).
8	SHLF_ID3	Signal used for identifying the board. Pulled up or down on board accordingly in the factory.

J2	Provides the contactor management interface for control and LVD status.
-----------	---

Pin #	Signal Name	Signal Description
1	LVD_COIL	Positive voltage applied to Low Voltage Disconnect Coil. Connect to positive side of contactor coil.
2	LVD_COILRTN	Contactor coil return to VBUS- potential through circuitry. Connect to most negative side of Contactor coil, other side of coil connected to VBus(+).
3	LVD_NC	Normally Closed contactor status monitor. Closed to LVD_C when contactor is open. Connect signal to NC pin of micro- switch of Contactor.
4	LVD_NO	Normally Open contactor status monitor indicator. Closed to LVD_C when contactor is closed. Connect signal to NO pin of micro-switch of contactor.

Note: The common or return of the micro switch for these signals shall be attached to Vbus- in the system outside of this board.

J3	Connection that provides field access to External Auxiliary Fuse Alarm Major and the Remote LVD input.
-----------	--

Pin #	Signal Name	Signal Description
1	Remote LVD	External contact closure for remote disconnecting attached LVD; Disconnects LVD on a dry contact closure to Remote LVD Return when feature is enabled.
2	Remote LVD Return	Protective (PTC or resistive) return to NE common for External Remote LVD contact closure input signal.
3	Aux_Alarm	General purpose Fuse Alarm Major (FAJ) alarm input; Major alarm on closure to the non-grounded "Battery" side of the DC bus Battery(-48V).

J100 and J101	Provides connectivity to the RS485 GP rectifier/converter bus as well as a pass through to the next RS485 connected device.
----------------------	---

Pin #	Signal Name	Signal Description
1	RS485+	B Inverting Driver Output / Inverting Receiver Input
2	RS485-	A Non-inverting Receiver Input/ Non-inverting Driver Output
3	RS485REF	RS485 Reference/return. Pass-through on this board.
4		No Connection
5	-	Connects between J101.5 and J100.5. Connection reserved for 1- wire communication signal in the system.
6	-	Connects between J101.6 and J100.6. Connection reserved for 1- wire +5V signal in the system.
7		No Connection
8		No Connection

Note: if these boards are to be used in custom configuration design consideration must be given to the selection of the non-latching contactor as well as thermal considerations when mounting the board. This board requires heat sinking and other thermal management techniques.

This page intentionally left blank

Troubleshooting

Controller LED	User Interface Display	Rectifier LED	Distribution Module Board LED	Possible Problem (s)	Possible Solution (s)
AMBER	MIN, AC Fail	None	GREEN	<p>Single Rectifier not receiving ac power.</p> <ul style="list-style-type: none"> AC input circuit breaker has opened. AC input voltage is out of range. 	<ol style="list-style-type: none"> Verify ac power to rectifier is available. Verify rectifier input circuit breaker is closed. If problem not corrected, replace rectifier.
RED	MIN, AC Fail MAJ, Multiple AC Fail MAJ, Battery on Discharge	None	GREEN	<p>Multiple rectifiers not receiving ac power, batteries are powering load.</p> <ul style="list-style-type: none"> AC input circuit breakers have opened. AC input voltage is out of range. Internal rectifier fault. 	<ol style="list-style-type: none"> Verify ac power to rectifiers is available. Verify rectifier input circuit breakers are closed. If problem not corrected, replace rectifier.
AMBER or RED	MIN, AC Fail MAJ, Multiple AC Fail	None	GREEN	<p>A rectifier, multiple rectifiers, or the entire system has lost AC and one or more rectifiers have been removed from the system while under this condition.</p>	<ol style="list-style-type: none"> Verify that ac power to all rectifiers is available. Verify that rectifiers all report good AC Issue the uninstall equipment under the operations menu for any rectifier that may have been removed during the AC fail.
RED	MAJ, Battery on Discharge	AC OK DC OK	GREEN	<p>Rectifier output voltage has fallen below the battery on discharge threshold set by the user.</p>	<p>If commercial ac power is present but the system voltage remains low, call your local field representative. Investigate other alarms that may be present such as rectifier related problems.</p>
AMBER	MIN, Rectifier Fail (Note 1)	AC OK ALARM (Note 1)	GREEN	<p>Rectifier output has dropped below 36V, rectifier has entered hiccup mode.</p>	<p>Replace rectifier.</p>
RED	MAJ, Rectifier Fail	AC OK ALARM (Note 1)	GREEN	<p>All rectifier outputs have dropped below 36V, all rectifiers have entered hiccup mode. Defective controller.</p>	<p>Remove controller; if output voltage does not go to set-point previously set by user, call your local field representative.</p>
RED	MAJ, Rectifier Fail (Note 1)	AC OK DC OK	AMBER (Blinking)	<p>One or both of the LVD contactors is open; someone may have manually opened LVD contactor.</p>	<p>Place disconnect switch in ON position.</p>
AMBER	MAJ, Contactor 1 Open	AC OK DC OK	GREEN	<p>Batteries have exceeded temperature threshold set by user.</p>	<p>Call your local field representative.</p>

Table 4 Power System Troubleshooting

Troubleshooting (Continued)

Controller LED	User Interface Display	Rectifier LED	Distribution Module Board LED	Possible Problem (s)	Possible Solution (s)
None	No response.	RED (Blinking)	RED (Blinking)	Controller failure, all devices on the communication bus reporting loss of communication with controller.	Check controller to ensure it is properly inserted into its slot. If so, perform the following steps: 1. Remove the controller board for 1 minute and then reset. 2. If problem persists, replace controller with new controller board. 3. If problem still persists, call your local field representative.
AMBER	MIN, Thermal probe Fail	AC OK DC OK	GREEN	Battery thermal probe failed.	1. Ensure thermal probe is properly connected to thermal probe cable. 2. Ensure cable is properly connected to the rear of the Distribution Module. 3. If problem persists, replace thermal probe per ensuing instructions. 4. If problem still persists, call your local field representative.
RED	MAJ, Fuse Major	AC OK DC OK	RED	One or more of the output circuit breakers or fuses have opened.	Reset circuit breakers or replace fuse.
AMBER	MIN, Rectifier Fail	AC OK ALARM	Normal	Single rectifier thermal alarm: Excessive ambient temperature Multiple rectifier failure	1. Verify that there is no obstruction of the vertical airflow path. 2. Reset the rectifier by removing the rectifier, waiting approximately 30 seconds, and replacing the rectifier. 3. If problem persists, replace the rectifier. 4. If problem still persists, call your local field representative.

Table 4 Power System Troubleshooting

Troubleshooting (Continued)

Controller LED	User Interface Display	Rectifier LED	Distribution Module Board LED	Possible Problem (s)	Possible Solution (s)
RED	1MIN, Rectifier Fail 2MAJ, Multiple Rectifier Fail 3MAJ, Battery on Discharge	4AC OK ALARM	5Normal	6Multiple rectifier thermal alarm: Excessive ambient temperature 7 Multiple rectifier failure	<ol style="list-style-type: none"> 1. Verify that there is no obstruction of the vertical air flow path. 2. Reset rectifies by removing them, waiting approximately 30s and replacing them. 3. If problem persists, replace the rectifiers. 4. If problem still persists, call your local field representative.
RED	MAJ, High voltage	AC OK ALARM	Normal	High output voltage from rectifier (s) Rectifier (s) high voltage shutdown Internal rectifier (s) failure	<ol style="list-style-type: none"> 1. Reset the rectifier (s) by removing the rectifier (s), waiting approximately 30s and replacing the rectifier (s). 2. If problem persists, replace the rectifier. 3. If problem still persists, call your local field representative.
Amber	MIN, Clock Battery Low	AC OK DC OK	Normal	Internal Lithium Battery Is Low	<ol style="list-style-type: none"> 1. The battery is not designed to be easily field replaced. The controller unit needs to be replaced. 2. Obtain all desired information such as alarm history, statistics, and any field configuration that is different than the standard.
AMBER	MIN, Minor Communication fail	RED Blinking Single rectifier	GREEN	Rectifier lost communication with controller.	<ol style="list-style-type: none"> 1. If a rectifier has been removed from an installed/operational system, go to the Control/Operations menu and execute Uninstall Equipment. 2. Reset the rectifier by removing the rectifier, waiting approximately 30 seconds, and replacing. 3. If problem persists, replace the rectifier. 4. If problem still persists, call your local field representative.

Table 4 Power System Troubleshooting

Troubleshooting (Continued)

Controller LED	User Interface Display	Rectifier LED	Distribution Module Board LED	Possible Problem (s)	Possible Solution (s)
RED	MAJ, Major Communication Fail	GREEN	RED (Blinking)	LVD Board lost communication with the controller.	<ol style="list-style-type: none"> 1. Replace Distribution Module Board. (Note 2) 2. If problem persists, call your local field
GREEN	No Alarm, Individual Shunt Currents displayed at or above their maximum display values ($\geq 600A$ for loads, $\geq 800A$ for battery)	AC OK DC OK	Normal	One or both of the QS871A shunt inputs is open-circuit.	<ol style="list-style-type: none"> 1. Verify that the respective shunt has its green and yellow wire connections attached used for the current measurements. 2. Verify the shunt connection to the QS871A is good by verifying the green and yellow wire connections from the shunt follows through to the 10-pin connector at the respective QS871A.

Table 4 Power System Troubleshooting

Note 1: While in hiccup mode, the rectifier will attempt to restart every 10 seconds for a maximum of 3 times.

Note 2: Refer to Section 5, LVD board Removal for removal details. Note that the power system will continue to power the load while the LVD board is out of the system; however, there will be no possibility of battery backup until the LVD board is replaced.

Checking for Defective VT-Probes

1. Disconnect the first probe from its RJ-45 terminal block.
2. Run the CLE function. If the system controller illuminates its LED in green color, the probe is defective. Alternatively, the number of registered probes may be known from the terminal interface (TI) by running the Number of Temperatures present command, see Appendix B. If the registered number of probes is equal to the total number of probes connected, remember you've removed a probe, so the total number should be one less than that during installation, and then the first probe is defective. Replace the probe with a different probe and follow the above procedure to ensure it is operational.
3. If the system controller LED remains green or the number of registered probes is still incorrect, replace the first probe and remove the second probe and repeat Step 2. Continue this procedure until the defective probe has been found.

Specifications

General Specification	
Item	Specification
Input Voltage Ranges (power)	48V: 36.5 volts to 60 volts 24V: 18.5 volts to 32 volts
Input Power	5.0 watts maximum
Input Power Connections	Shelf powered. No external connection required;
Bonding Network	Suitable for installation as part of either <ul style="list-style-type: none"> • Common Bonding Network (CBN) • an Isolated Bonding Network (IBN)
Facilities	Suitable for installation in <ul style="list-style-type: none"> • Network Telecommunication Facilities • Locations where the NEC applies
DC Return	<ul style="list-style-type: none"> • Isolated DC Return (DC-I) or • Common DC Return (DC-C)
Front Panel Interface	<ul style="list-style-type: none"> • Asynchronous RS232 or USB Craft Port • Two status LEDs • Options with LCD Interface
System Configuration Methods	<ul style="list-style-type: none"> • Front panel Craft port with T1.317 or EasyView2 • 10/100 Base-T port • Serial port with external MODEM option
Maximum Power Units	<ul style="list-style-type: none"> • 12 CP, 6 SPS-EPs, 32 NEs, 24 QS in ID mode • Many more in ID override mode (app dependent)
Low-Voltage Disconnects	<ul style="list-style-type: none"> • Up to eight remote LVD contactors with 3 independent configurable Load disconnect thresholds (LVLDS) and 1 configurable Battery disconnect threshold (LVBD) • Integrated control/monitor capability for single LVD with remote distribution control modules
Temperature Monitoring	<ul style="list-style-type: none"> • Up to 16 One-Wire battery temperature probes • Controller ambient sensor built into LCD display

System Input/Output Specification	
SELV	All input and output connections comply with SELV requirements.
Connections - Ports	<p>CAUTION</p> <p>Intra-building ports of the equipment or subassembly</p> <ul style="list-style-type: none"> • are suitable for connection only to shielded intra-building or unexposed wiring or cabling grounded at both ends. • MUST NOT be metallically connected to interfaces which connect to the OSP or its wiring. <p>These interfaces are designed for use as intra-building interfaces only (Type 2 or Type 4 ports as described in GR-1089-CORE, Issue 5) and require isolation from the exposed OSP cabling. The addition of Primary Protectors is not sufficient protection. All controller ports are intra-building except the phone port of the BSM6 Modem.</p>
Alarm and Control Inputs	<ul style="list-style-type: none"> • Six configurable system alarm inputs of the closure/open to "VBus-" or -48V • Up to 9 customer inputs of the closure/open to return type
Alarm Contact Outputs	Up to 6 User configurable Form-C Outputs ⁴
Alarm Contact Ratings	60 VDC, 0.5A

Specifications (Continued)

System Input/Output Specification		
Plant Voltage Measurement		±0.05% of full scale + 1 count
Accuracy	0 to 50°C	48V Systems: ±40 mV; 24V Systems ±25 mV
	-40 to 75°C	±0.1% of full scale + 1 count)
Resolution		48V Systems: ±70 mV; 24V Systems ±40 mV 0.01V
Plant Current Measurement		
Accuracy	0 to 50°C	±0.5% of full scale
	-40 to 85°	±1.25% of full scale
C		1A
Resolution		
Temperature Measurement One-Wire Probe		
Accuracy	-5 to +55°C	±1°C
	-40 to +85°C	±3°C
Resolution		0.1°C

Environmental Specification	
General	Specification
Operating Temperature Range	-40 to 75°C (-40 to 167°F)
Storage Temperature Range	-40 to 85°C (-40 to 185°F)
Altitude	-200 to 13,000 feet (-61 to 3962 meters) ⁵
Humidity	10% to 95% non-condensing
Audible Noise	< 60 dBA
Earthquake Rating	Zone 4, upper floors
Controlled Environment	Use this equipment in a controlled environment (an area where the humidity is maintained at levels that cannot cause condensation on the equipment, the contaminating dust is controlled, and the steady-state ambient temperature is within the range specified).

Installation Area Specifications	
Item	Specification
Installation Area Limitations	Store and operate this equipment in a controlled environment, an area where the humidity is maintained at levels that cannot cause condensation on the equipment, the contaminating dust is controlled, and the steady-state ambient temperature is within the range specified.

Operation Without Batteries	
Item	Specification
Suitability without Batteries	Suitable for use in power plants with or without batteries.
Loss of AC Power without Batteries	Loss of ac power causes <ul style="list-style-type: none"> • Controller DC power is lost • Controller alarm relays are activated (unpowered)
Recovery from Loss of AC Power without Batteries	Restoration of AC power causes <ul style="list-style-type: none"> • Rectifiers return to their configured voltage set point • Controller DC power is restored • Controller automatically return to its last configuration Alarm relays reflect actual alarm states

Specifications (Continued)

Safety / Standards Compliance Specification	
Item	Specification
Safety Agency Approvals	Underwriters Laboratories (UL) Listed per Subject Letter 1801: Power Distribution Center for Communications Equipment, and cUL Certified (CSA 22.2 950): Safety of Information Technology Equipment
European Economic Community (EEC) Directives	EMC Directive 89/336/EEC, Low Voltage Directive 73/23/EEC as amended by Marking Directive 93/68/EEC
Radiated and Conducted Emissions	FCC Part 15, Class A EN55022 (CISPR22), Class A
Electromagnetic Immunity	Meets Telcordia GR-1089-CORE
Electrostatic Discharge	EN61000-4-2 Level 1-4
RF Immunity	IEC61000-4-3 Level 3, 10 V/m
Conducted Immunity	IEC 61000-4-6 Level 3, Input Power Ports IEC 61000-4-6 Level 2, Telecom Ports
Voltage Dips, Interruptions, and variation	IEC 61000-4-11, EN55024 (CISPR24)

This page intentionally left blank

Safety

Safety Statements

See equipment specifications for installation and environmental limitations.

- Do not install this equipment over combustible surfaces.
- Rules and Regulations - Follow all national and local rules and regulations when making field connections.
- Compression Connectors
 - U. S. or Canada installations - use Listed/Certified compression connectors to terminate Listed/Certified field-wire conductors.
 - All installations - apply the appropriate connector to the correct size conductor as specified by the connector manufacturer, using only the connector manufacturer's recommended or approved tooling for that connector.
- Electrical Connection Securing: Torque to the values specified on labels or in the product documentation.
- Cable Dress - dress to avoid damage to the conductors and undue stress on the connectors.
- Circuit Breakers and Fuses
 - Use only those specified in the equipment ordering guide.
 - Size as required by the National Electric Code (NEC) and/or local codes.
 - Safety Tested Limits - Refer to the equipment ratings to assure current does not exceed: Continuous Load (List 1) - 60% of protector rating
 - Maximum Load (List 2 - typically end of discharge) - 80% of protector rating.
 - GMT Style Fuses - Use only fuses provided with safety caps.
- Field-wired Conductors - Follow all National Electric Code (NEC) and local rules and regulations.
 - Insulation rating: 90°C minimum; 105°C (minimum) if internal to enclosed equipment cabinets.
 - Size AC field-wired conductors with 75°C ampacity (NEC) equal to or greater than their panel board circuit breaker rating.
- AC and DC input disconnect/protection - Provide accessible devices to remove input power in an emergency.
- Alarm Signals - Provide external current limiting protection. Rating 60V, 0.5A unless otherwise noted.
- Grounding - Connect the equipment chassis directly to ground. In enclosed equipment cabinets connect to the cabinet AC service ground bus. In huts, vaults, and central offices connect to the system bonding network.

Precautions

- Install, service, and operate equipment only by professional, skilled and qualified personnel who have the necessary knowledge and practical experience with electrical equipment and who understand the hazards that can arise when working on this type of equipment.
- Disconnect batteries from outputs and/or follow safety procedures while working on equipment. Batteries may be connected in parallel with the output of the rectifiers. Turning off the rectifiers will not necessarily remove power from the bus.
- Do not disconnect permanent bonding connections unless all power inputs are disconnected.
- Verify that equipment is properly safety earth grounded before connecting power. High leakage currents may be possible.

- Exercise care and follow all safety warnings and practices when servicing this equipment. Hazardous energy and voltages are present in the unit and on the interface cables that can shock or cause serious injury. When equipped with ringer modules, hazardous voltages will be present on the ringer output connectors.
- Use the following precautions in addition to proper job training and safety procedures:
 - Use only properly insulated tools.
 - Remove all metallic objects (key chains, glasses, rings, watches, or other jewelry).
 - Follow Lock Out Tag Out (LOTO) procedures: customer specified, site specific, or general as appropriate. Disconnect all power input before servicing the equipment. Check for multiple power inputs.
 - Wear safety glasses.
 - Follow Personal Protective Equipment requirements: customer specified, site specific, or general as appropriate.
 - Test circuits before touching.
 - Be aware of potential hazards before servicing equipment.
 - Identify exposed hazardous electrical potentials on connectors, wiring, etc.
 - Avoid contacting circuits when removing or replacing covers;
 - Use a personal ESD strap when accessing or removing electronic components.
- Personnel with electronic medical devices need to be aware that proximity to DC power and distribution systems, including batteries and cables, typically found in telecommunications utility rooms, can affect medical electronic devices, such as pacemakers. Effects decrease with distance.

Appendix A: Software Backup / Restore Through Network Connection

Software can be upgraded through the 10/100Base-T connection either over the network or when the port has been configured to be used as an Ethernet Craft Port. There are four program files that can be upgraded on the Pulsar Edge: The boot block, the factory defaults, application, and web pages. Each of these items has a specific file name. FTP is used for upgrading controller software. Each file goes in a certain directory on the controller:

Item	File	Directory
Boot Block	cp841-boot.bin	/
Defaults	cp841-dflts.bin	dflts
Application	cp841-app.bin	code
Web pages	cp841-pages.web	web
Backup Configuration	config.gal	config

These files must be uploaded to the Pulsar Edge using FTP either through the web page interface or through a direct Telnet session. To use FTP, the user must first initiate a Telnet session through the Craft port or network connection. To use the Ethernet port locally as a Craft port it needs to be configured as a DHCP Server. DHCP Server operation can be validated at Menu → Status → Network Settings. Scroll down to view the port's present configuration.

If it is not in DHCP Server mode, make sure the Craft port is not plugged into a LAN connection and re configure the DHCP setting from the front panel to be Server. This parameter is found in

Menu → Configuration → Communication Ports → Network Settings → DHCP. Note: the controller should automatically reboot to accept the new Ethernet port configuration. This process takes approximately two minutes.

Common FTP commands used when performing file operations are:

ftp – Initiate the ftp session.

cd – Change directories in the controller.

put – Copy files from the PC running FTP to the controller (The present working directory of the PC will be the source directory for the file being copied.)

get – Copy files from the controller to the PC running FTP (The present working directory of the PC will be the destination directory for the file being copied.)

bye – Exit the FTP session

pwd – Display the path of the current directory

rm – Remove a file from a directory

ls – List all files in a directory

Note: The Pulsar Edge has a file/directory structure as shown below: Where “/” is the root directory. Each subdirectory contains files that are necessary for the Application Software and web pages. Thus, using an FTP client, shown previously, files may be transferred to/from these controller directories. The exact path to the upgrade file may be used in the “put” command to update the software. Note: software upgrades require administrator level privilege. Thus, the password required is administrator. Similar responses are seen when opening a Telnet session remotely over the LAN connection. Note: you have to give the path of to the file in conjunction with the put commands.

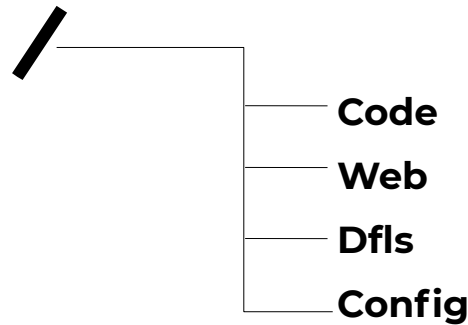

Boot Block Software

Config

Using any FTP client, perform the following steps to load Application Software:

1. Change your directory to the PC directory where the Application code is stored.
2. Type: FTP x.x.x.x (The controller should have a Working IP Address of 192.168.2.1).
ftp 192.168.2.1
 Connected to 192.168.2.1
 220 841 FTP Ready
3. Login as guest using the network administrator password (administrator).
 User (192.168.2.1:(none)): guest
 331 User name okay, need password Password: administrator
 230 Logged in
4. Change directory (cd) to the main **boot block** directory by typing: cd /.
 ftp> **cd /**
 250 CWD command successful
5. Use the put command to copy the application software to the controller.
 ftp> put cp841-boot.bin
 200 Port command okay
 150 Opening data connection for STOR (192.168.2.1,1576)
6. Wait until the message indicating a successful file transfer is displayed. 226 File sent OK
 ftp: 917504 bytes sent in 2.31Seconds 396.50Kbytes/sec.
7. Type bye to exit/logout of the FTP session.
8. ftp> **bye**
 221 Goodbye!

Factory Defaults

Using any FTP client, perform the following steps to load default web pages:

1. Type: FTP x.x.x.x (The controller should have a Working IP Address of 192.168.2.1).
ftp 192.168.2.1
 Connected to 192.168.2.1
 220 841 FTP Ready
2. Login as guest using the using the network administrator password (administrator).
 User(192.168.2.1:(none)): guest
 331 User name okay, need password Password: administrator
 230 Logged in
3. Change directory (cd) to the dflts directory by typing: cd dflts.
 ftp> cd dflts
 250 CWD command successful
4. Use the put command to copy the web pages to the controller.
 ftp> **put cp841-dflts.bin**
 200 Port command okay
 150 Opening data connection for STOR (192.168.2.1,1576)
5. Verify the transfer by a message displayed indicating a successful file transfer. 226 File sent OK
 ftp: 917504 bytes sent in 2.31Seconds 396.50Kbytes/sec.
6. Type bye to exit the FTP session.
 ftp> **bye**
 221 Goodbye!

Application Software

Using any FTP client, perform the following steps to load Application Software:

1. Change your directory to the PC directory where the Application code is stored.
2. Type: FTP x.x.x.x (The controller should have a Working IP Address of 192.168.2.1).
ftp 192.168.2.1
 Connected to 192.168.2.1
 220 841 FTP Ready
3. Login as guest using the network administrator password (administrator).
 User (192.168.2.1:(none)): guest
 331 User name okay, need password
 Password: administrator
 230 Logged in
4. Change directory (cd) to the **code** directory by typing: cd code.
 ftp> **cd code**
 250 CWD command successful

- Use the put command to copy the application software to the controller.

```
ftp> put cp841-app.bin
      200 Port command okay
      150 Opening data connection for STOR (192.168.2.1,1576)
```

- Wait until the message indicating a successful file transfer is displayed.

```
      226 File sent OK
ftp: 917504 bytes sent in 2.31Seconds 396.50Kbytes/sec.
```

- Type bye to exit/logout of the FTP session.

```
ftp> bye
      221 Goodbye!
```

Web Pages

Using any FTP client, perform the following steps to load default web pages:

- Type: FTP x.x.x.x (The controller should have a Working IP Address of 192.168.2.1).

```
ftp 192.168.2.1
```

```
Connected to 192.168.2.1
```

```
220 841 FTP Ready
```

- Login as guest using the using the network administrator password (administrator).

```
User (192.168.2.1:(none)): guest
```

```
331 User name okay, need password
```

```
Password: administrator
```

```
230 Logged in
```

- Change directory (cd) to the **web** directory by typing: cd web.

```
ftp> cd web
```

```
250 CWD command successful
```

- Use the put command to copy the web pages to the controller.

```
ftp> put cp841-pages.web
```

```
200 Port command okay
```

```
150 Opening data connection for STOR (192.168.2.1,1576)
```

- Verify the transfer by a message displayed indicating a successful file transfer.

```
226 File sent OK
```

```
ftp: 917504 bytes sent in 2.31Seconds 396.50Kbytes/sec.
```

- Type bye to exit the FTP session.

```
ftp> bye
```

```
221 Goodbye!
```

Backup/Restore Configuration File

Using any FTP client, perform the following steps to load default web pages:

- Type: FTP x.x.x.x (The controller should have a Working IP Address of 192.168.2.1).

ftp 192.168.2.1

Connected to 192.168.2.1

220 841 FTP Ready

2. Login as guest using the using the network administrator password (administrator).

User (192.168.2.1:(none)): guest

331 User name okay, need password Password: administrator

230 Logged in

3. Change directory (cd) to the **config** directory by typing: cd config.

ftp> **cd config**

250 CWD command successful

Backing Up/Retrieving

4. To retrieve a backup of a site's configuration use the get command to get a copy of the configuration file (config.gal).

ftp> **get config.gal**

200 Port command okay

150 Opening data connection for STOR (192.168.2.1,1576) 226 File sent OK

Restoring

4. To restore a backup of a site's configuration use the put command to load a copy of the configuration file (config.gal) to the site.

ftp> **put filename config.gal**

Note: The full path of to the file with the filename must be provided. It is OK just to use the same name with a command like the following:

ftp> **put config.gal**

200 Port command okay

150 Opening data connection for STOR (192.168.2.1,1576)

5. Verify the transfer by a message displayed indicating a successful file transfer. 226 File sent OK

ftp: 917504 bytes sent in 2.31Seconds 396.50Kbytes/sec.

6. Type bye to exit the FTP session.

ftp> **bye**

221 Goodbye!

The software can also be uploaded through the web pages as described in Section 5. Login into through the web pages as "administrator" and go to the "Software" tab and use the appropriate easy to use tab: **"Upgrade Software"**, **"Restore Configuration"**, or **"Backup Configuration"**. A Sample screen shots are shown below.

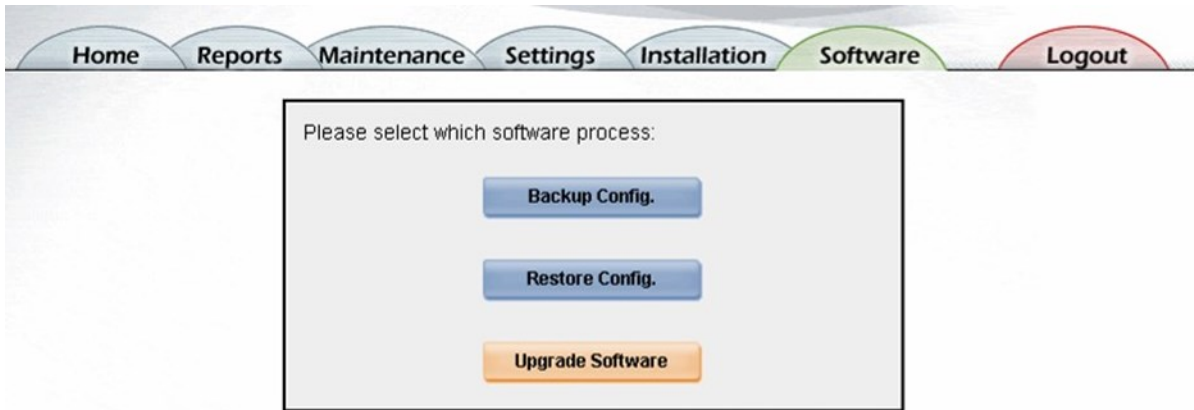

Clicking the "Upgrade Software" button provides an interface to select which file is to be upgraded as well as a tool to help select the location of the file to upload. Following is a sample screen

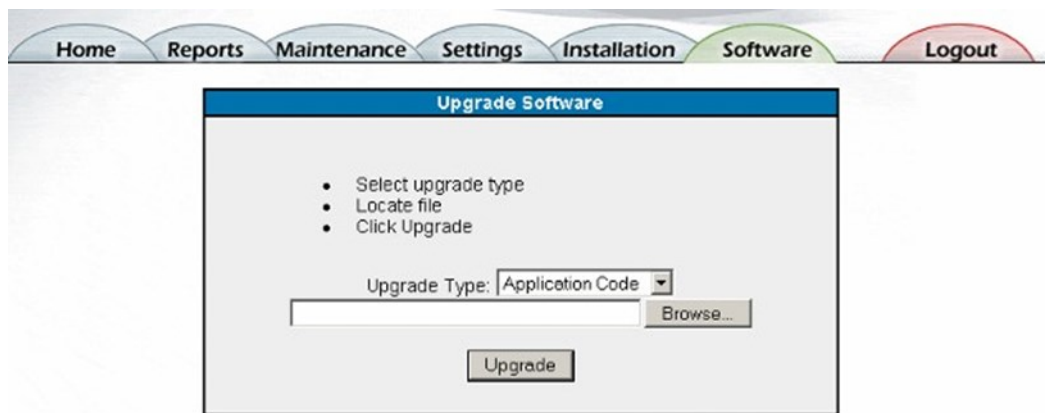

Appendix B: T1.317 Command Language

Serial Access to the Pulsar Edge Controller

RS-232 Terminal/Modem Port

The Pulsar Edge is a highly flexible controller with many features. This section outlines programming the controller using the Hyper Terminal program that is shipped with most IBM compatible PC's. Connect the cable between the computer RS-232 port, and the Pulsar Edge System Controller RS-232 port, J6. After Hyper Terminal has started and the programming cable is connected to the controller and the PC, you should see the login screen that allows access to the Pulsar Edge programming features.

RS-232 Terminal/Modem Port

This interface provides a T1.317 interface for local or dial-out access. The local port DTR signal switches the port personality from modem to terminal. This interface provides access to all status, configuration, and operations. It also provides call-out on alarm capability.

The controller communicates with the modem using the following settings:

Baud Rate: 9600
 Data Bits: 8
 Stop Bits: 1
 Parity: None

Logging On

Three levels of security protect incoming access: user, super-user, and administrator. A user has read ability and can only get status information from the Pulsar Edge. A super-user can change configurations and perform control operations. An administrator has all the abilities of a super-user but can also change passwords. All access to Pulsar Edge is via the T1.317 command set, to be discussed later.

This section describes how to log into the system via an RS-232 local port. The first step to logging in is to get to an "ENTER PASSWORD:" prompt. From a terminal connected to the RS-232 port, simply press ENTER until you see the log-in prompt. The number of ENTER keys required will depend on the baud rate you are trying to connect at. The controller will adjust its baud rate automatically until it recognizes the carriage return character (ASCII 13) sent by pressing ENTER.

At the "ENTER PASSWORD:" prompt, type the user or super-user password. The default password for each level of security is listed below.

Default User password	XXXXX
Default Super-user password	super-user
Default Administrator password	administrator

After receiving the correct password, the controller will respond with one of the following command line prompts:

User command-line prompt: *

Super-user command-line prompt: **

When these prompts appear the controller is ready to accept commands. Note that the session will be terminated if the port is idle for 15 minutes.

Introduction

The Pulsar Edge command language is based on the T1.317 standard. This section describes the commands, objects and attributes used to access measurements, configuration, and control parameters in the Pulsar Edge controller.

The T1.317 standard organizes system parameters called attributes into groups called objects. All commands, objects, attributes and ranges for their respective parameters for the Pulsar Edge controller are given in the following tables.

An object-attribute pair uniquely identifies a measurement, configuration, or control parameter. For example, the object-attribute pair “dc1,vdc” identifies the plant voltage while the object-attribute pair “dc1,adc” identifies the plant load current. In each of these examples “dc1” identifies the plant object and “vdc” and “adc” identify DC voltage and DC current, respectively.

There are three main commands involved with plant operations in the system controller command set. The command “**sta**” is used to get the status of the plant, the command “**cha**” is used to change a plant parameter, and the command “**ope**” is used to initiate a plant function. A person at the “user” level can only perform the sta operations. A person at the “super-user” and “administrator” level can also perform the “cha” and “ope” operations.

Instructions in the T1.317 command set take the following form:

```
command object,attribute[=parameter].
```

Certain commands do not require a value for parameter, while others do. Note that text parameters are to be enclosed in quotation marks while numeric parameters are not to be enclosed in quotation marks.

For example, to obtain the plant voltage, type in the following command:

```
sta dc1,vdc
```

To enable low-temperature slope thermal compensation, type in the following command:

```
cha sc1,rve=1
```

To change the voltage at which the LVD contactor disconnects the batteries from the load to 40V, type the following:

```
cha cn1,dth=40
```

Note: all IP addresses and their associated descriptions are required to be in quotes “” when using the cha command.

To initiate a manual boost charging, i.e., place the plant into boost charging mode, type in the following command:

```
ope dc1,stt=“boost”
```

The tables below summarize the object-attribute pairs in the system along with the commands that can be used with the pair and the valid range that the attribute may have. The values in bold text are the default settings for the attributes.

Objects, Attributes, and Related Commands

PSM- Power System						
Obj,attr	Description	Related Commands			Type	Range of Values
		Sta	Cha	Ope		
psl,ide	Identifier	√			text	PSI
psl,des	Power system description	√			text	≤ 32 characters
psl,sid	Site ID	√	√		text	Up to 20 characters
psl,sde	Site Description	√			text	Up to 55 characters
psl,sys	System Description	√	√		text	Up to 55 characters
psl,swv	Software version	√			text	d.d
psl,verw	Web pages version	√			text	d.d
psl,verb	Boot block version	√			text	d.d
psl,verd	Display version	√			text	d.d
psl,dflt	Defaults version	√			text	d.d
psl,brc	Board code	√			text	""
psl,sn	Serial number	√			text	YYLLdddddddd
psl,dow	Day of week	√			text	Sunday...Saturday
psl,dat	Date	√	√		date	format matching psl,dtf
psl,dtf	Date format	√	√		text	mm-dd-yyyy, dd-mm-yyyy, yyyy-mm-dd
psl,tim	Time	√	√		time	hh:mm
psl,tmf	Time format	√	√		number	12, 24
psl,dls	Daylight savings enable	√	√		number	0=disabled 1=enabled
psl,tzo	Time zone offset	√	√		number	-840 - +840 minutes (±14
psl,lng	Language	√	√	√	text	ENGLISH, OTHER
psl,tun	Temperature units	√	√		text	C, F
Ps1,cem	Critical equals major	√	√		number	0=disable, 1=enable
psl,fpc	Front panel configuration	√	√		number	0=disable, 1=enable
psl,rrf	Remote rectifier off	√	√		number	0=disable, 1=enable
psl,poe	Power off enable	√	√		number	0=disable, 1=enable
psl,usl	Uninstall missing equipment	√		√	number	1
psl,usr	Username enable	√	√		number	0=disable, 1=enable
psl,dct	Display contrast	√	√		number	0 – 100 %
psl,ptt	Communication port type	√	√		text	"LOCAL","MODEM"
psl,amt	System ambient temperature	√			number	dd °C
psl,fst	Factory defaults	√		√	text	See psl,fstl
psl,fstl	Factory defaults list	√			text	Comma delimited list of defaults
psl,rap	Reset Passwords	√		√	number	1 = reset passwords (OPE only valid from local display) will restore passwords.gal
psl,fpe *	Front Panel Pin enable	√	√		number	0=disable, 1=enable
psl,fpt *	Front Panel Pin Time-out	√	√		Number	1-120 minutes
Ps1,fpp*	Front Panel Pin	√	√		Number	4 digit Pin (only viewable as admin)
psl,rss	Restart all	√		√	number	1=restart rectifiers and ringers
psl,ltt	Lamp test	√		√	number	1 = do lamp test

PSM- Power System						
Related Commands						
Obj,attr	Description	Sta	Cha	Ope	Type	Range of Values
psl,ast	System alarm state	√			Text	"NORM", "RO", "WRN", "MIN","MAJ", "CRIT"
psl,slv	Port security level	√			text	
psl,dss	Daylight saving start	√	√		d:d:d:d	mon:wk:dow:min mon:-1:dom:min
psl,dse	Daylight saving end	√	√		d:d:d:d	mon:wk:dow:minmon:-1:dom:min
psl,uet	Uninstall Timeout	√	√		Number	0-60
psl,LEDL	List for LED alarm attribute	√			text	Comma delimited list of LEDs
psl,ACCL	List for ACC alarm attribute	√			text	Comma delimited list of Relays
psl,cid	System configuration IDOverride	√	√		number	0=disable, 1=enable

*Must have administrator privileges to change.

USR- User Login						
Related Commands						
Obj,attr	Description	Sta	Cha	Ope	Type	Range of Values
x,ide	Identifier	√			text	USR01-USR14, ADM1
x,des	Description	√	√		text	User Account 1-14 Administrator Account
x,pwd	Password	√	√		text	15 characters
x,usr	User name	√	√		text	15 characters
x,lvl	Security level	√	√		text	"USER", "SUPER-USER", "ADMINISTRATOR"
dc1,ide	Description	√	√		text	DC1
dc1,des	Description	√	√		text	DC Plant 1
dc1,typ	Plant Type	√	√	√	number	48V, 24V
dc1,vdc	Plant voltage	√		√	number	dd.dd V
dc1,adc	Plant load current	√		√	number	ddd.d A
dc1,cap	Total installed rectifier capacity	√			number	ddd.d A
dc1,olcap	Total on-line rectifier capacity	√			number	ddd.d A
dc1,trd	Plant total rectifier drain	√			number	ddd.d A
dc1,sht	Centralized plant shunt type	√	√		Text	"NONE", "BATTERY", "LOAD"
dc1,sha	Centralized plant shunt size	√	√		Number	0=disabled 1-9999
dc1,slt	Plant state	√		√	text	"FLOAT", "BOOST"
dc1,bod	Battery on discharge	√			number	0=on discharge 1=not on discharge
dc1,ems	Efficiency state	√			number	0=inactive 1=active
dc1,eme	Efficiency enable	√	√		number	0=disable 1=enable
dc1,emt	Efficiency target	√	√		number	20% to 95% of rectifier capacity
dc1,emo	Efficiency rectifier turn on threshold	√	√		number	25% to 100% of rectifier capacity
dc1,rsr	Rectifier restart	√		√	number	0=no action 1=restart
dc1,rsq	Rectifier sequencing	√	√		number	0=disable 1=enable
dc1,ron	User Group TR request	√		√	Number	0-3 LSB = User, MSB=PBT
dc1,rot	All Rectifier On Threshold	√	√		number	20-25or 40-50 volts
dc1,nst	Number of battery strings	√	√		number	1-70
dc1,cps	Number of Cells per String	√	√		number	1-75 (24V plant) or 24 (48V plant)

USR- User Login						
Related Commands						
Obj,attr	Description	Sta	Cha	Ope	Type	Range of Values
dc1,bty	Battery type	√	√	√	Text	See battery type definitions default (OPE causes battery Defaults to be loaded)
dc1,isd	Imminent shutdown enable	√	√		number	0=disable 1=enable
dc1,rtm	Actual reserve time	√			text	Low Current-Batt current too low High Current-Batt current too high dd.d (in hours)
dc1,scap	String capacity	√	√		number	
dc1,mls	All load shunts monitored	√	√		number	0=disable 1=enable

DTA - Alarms With Two Thresholds						
Related Commands						
Obj,attr	Description	Sta	Cha	Ope	Type	Range of Values
objid,ide	Identifier	√			text	see below
objid,des	Description	√	√		text	see below
objid,fds	Front Panel Description	√	√		text	see below
objid,ast	Alarm state	√			number	0=not active 1=active
objid,led	LED	√	√		text	BD,AC,DC,""
objid,sev	Alarm severity	√	√		text	CRIT, MAJ, MIN, WRN, RO
objid,ftb	Alarm boost threshold	√	√		number	see below
objid,bth	Alarm float threshold	√	√		number	see below
objid,acc	Contact Closure	√	√		text	R1,R2,R3,R4,R5,R6,R7,""
objid,dly	Notify Delay	√	√		number	0-540 seconds
objid,noo	Notify On Occur	√	√		number	0=no 1=yes
objid,nor	Notify On Retire	√	√		number	0=no 1=yes
objid,nag	NAG On Occur	√	√		number	0=no 1=yes
objid,dst	Notify Destination	√	√		text	"" , P1, P2, P3, P4, E1, E2, E3,E4, S1, S2, S3, S4

DTA - Alarms With Two Thresholds			
Objid	Description	Float Threshold	Boost Threshold
bda1	Battery On Discharge	23-28 V or 46-55 V	23-28 V or 46-55 V
hfv1	High voltage	24.75-29.75 V or 50-60 V	25.75-31.75 V or 52-60 V
hva1	Very high voltage	24.75-29.75 V or 50-60 V	25.75-31.75 V or 52-60 V

THA - Alarms With One Threshold						
Related Commands						
Obj,attr	Description	Sta	Cha	Ope	Type	Range of Values
objid,ide	Identifier	√			text	see below
objid,des	Description	√	√		text	see below
objid,fds	Front Panel Description	√	√		text	see below
objid,ast	Alarm state	√			number	0=not active 1=active
objid,sev	Alarm severity	√	√		text	CRIT, MAJ, MIN, WRN, RO
objid,thr	Alarm threshold	√	√		number	number
objid,led	LED	√	√		text	BD,AC,DC,""
objid,acc	Contact Closure	√	√		text	R1,R2,R3,R4,R5,R6,R7,""
objid,dly	Notify Delay	√	√		number	0 -540 seconds
objid,noo	Notify On Occur	√	√		number	0=no 1=yes

Objects, Attributes, and Related Commands (Continue)

THA - Alarms With One Threshold						
Related Commands						
Obj,attr	Description	Sta	Cha	Ope	Type	Range of Values
objid,nor	Notify On Retire	√	√		number	0=no 1=yes
objid,nag	NAG On Occur	√	√		number	0=no 1=yes
objid,dst	Notify Destination	√	√		text	"" , P1, P2, P3, P4, E1, E2, E3, E4, S1, S2, S3, S4

THA - Alarms With One Threshold		
Objid	Description	Threshold
amth1	High ambient temp	30-75C
amtl1	Low ambient temp	-40-10C
btha1	High battery temperature	30-85C
Btla1	Low Battery Temperature	-40C to 10C
Btvh1	Very High Battery Temperature	30C to 85C
Btv1	Very Low Battery Temperature	-40C to 10C
macf1	Multiple AC Fail	2-88
mrfa1	Multiple Rectifier Fail	2-88
mman1	Multiple Manual Off	2-88
rrtl1	Real-time reserve low	0-100hrs
rtl1	Reserve time low	0-100hrs
rls1	Redundancy Loss	1-87
vla1	Very low voltage	20-25.5 Vor 40-51 V

SDA- Alarms With No Threshold						
Related Commands						
Obj,attr	Description	Sta	Cha	Ope	Type	Range of Values
objid,ide	Identifier	√			text	see below
objid,des	Description	√	√		text	see below
objid,fds	Front Panel Description	√	√		text	see below
objid,ast	Alarm state	√	√		number	0=not active 1=active
objid,sev	Alarm severity	√	√		text	CRIT, MAJ, MIN, WRN, RO
objid,led	LED	√	√		text	BD,AC,DC, ""
objid,acc	Contact Closure	√	√		text	R1,R2,R3,R4,R5,R6,R7, ""
objid,dly	Notify Delay	√	√		number	0-540 seconds
objid,noo	Notify On Occur	√	√		number	0=no 1=yes
objid,nor	Notify On Retire	√	√		number	0=no 1=yes
objid,nag	NAG On Occur	√	√		number	0=no 1=yes
objid,dst	Notify Destination	√	√		text	"" , P1, P2, P3, P4, E1, E2, E3, E4, S1, S2, S3, S4

Objects, Attributes, and Related Commands (Continued)

SDA- Alarms With No Threshold	
Obj	Description
AAC1	ACO Active
ACF1	AC Fail
AMJ1	Auxiliary Major
ATA1	Alarm Test Active
ATB1	Alarm Test Aborted
AUX1	Air Conditioner Fail
AUX2	Door Open
AUX3	High External Ambient
AUX4	Low External Ambient
AUX5	Fan Fail
AUX6	Hydrogen present
BBL1	Real Time Clock Battery Low
BFA1	Battery Test Failed
BTA1	Battery Test Active
CCH1	Configuration Changed
CLC1	Clock Changed
CLM1	Rectifier Current Limit
CMA1	Minor Communication Fail Alarm
CNF1	LVBD 1 Failed
CNF2	LVL 1 Failed
CNF3	LVL 2 Failed
CNF4	LVL 3 Failed
CNO1	LVBD 1 Open
CNO2	LVL 1 Open
CNO3	LVL 2 Open
CNO4	LVL 3 Open
COF1	Queue Overflow
COR1	No Call-Out Response
DID1	ID Conflict
EMD1	Energy Management Disabled
EPO1	Emergency Power Off

SDA- Alarms With No Threshold	
Obj	Description
EPR1	External Password Reset
EXL1	Excessive Login Attempts
FAJ1	External Fuse Major
FAN1	External Fuse Minor 24V
HCL1	History Cleared
ICR1	Incompatible Rectifier
ISD1	Imminent Low V Shutdown
LSF1	Load Share Fail
MAN1	Manual Off
MCM1	Major Communication Fail Alarm
MDP1	Voltage Duplicate ID
MZD1	Voltage ID Not Configured
NNC1	Unconfigured Alarm Destination
OSA1	Open String
PFD1	Password At Default
PFS1	Thermal Probe Fail Safe
PGI1	Program Line Invalid
PHT1	Processor Halt
POR1	No Dial-Out Response
RFA1	Rectifier Fail
RFN1	Rectifier Fan Fail
RIF1	Rectifier Internal Fault
SCD1	Battery Voltage Imbalance
STF1	Self Test Failed
TPA1	Thermal Probe Failure
VMF1	Voltage Channel Failure
VSF1	Sense/Control Fuse
ZID1	ID Not Configured

RMN-Rectifier Management						
		Related Commands				
Obj,attr	Description	Sta	Cha	Ope	Type	Range of Values
gm1,ide	Identifier	√			Text	GM1
gm1,des	Description	√	√		Text	Rectifier Manager 1
gm1,lse	Load Share Enable	√	√		number	0=disable 1=enable
gm1,rme	Redundancy monitor enable	√	√		number	0=disable,1=enable
gm1,fsd	Float High Voltage Shutdown	√	√		number	25-30 or 50-60 V
gm1,bsd	Boost High Voltage Shutdown	√	√		number	26-30 or 52-60 V
gm1,fsp	Float Set-Point	√	√		number	22-28 or 44-56.5 V
gm1,bsp	Boost Set-Point	√	√		number	22-30 or 48-60 V
gm1,fcl	Float Current Limit	√	√		number	30-110%
gm1,bcl	Boost Current Limit	√	√		number	30-110%
gm1,oft	Oring FET Test Enable	√	√		number	0=disable 1=enable
gm1,wie	Walk-In Enable	√	√		number	0=disable 1=enable

REC-Rectifiers						
Related Commands						
Obj,attr	Description	Sta	Cha	Ope	Type	Range of Values
gsr8,des	Description	√	√		text	Rectifier sr6
gsr8,typ	Rectifier Type	√	√		text	12 char
gsr8,sn	Serial number	√			text	Up to 18 characters
gsr8,adc	DC Current (VI, VIR)	√			number	number A
gsr8,vdc	DC Voltage	√			number	number V
gsr8,slt	Individual rectifier state	√		√	text	ON7, OFF7, STANDBY7, VACANT7, MISSING
gsr8,cap	Capacity	√			number	number A
gsr8,aac	AC Current	√			number	number A
gsr8,vac	AC Voltage	√			number	number V
gsr8,tmp	Temperature	√			number	number F or C
gsr8,seq	Use In Sequence Enable	√	√		number	0=no 1=yes
gsr8,rfa	Rectifier Fail	√			number	0=inactive 1=active
gsr8,acf	AC Fail	√			number	0=inactive 1=active
gsr8,man	Standby or Manual Off	√			number	0=inactive 1=active
gsr8,did	ID Conflict	√			number	0=inactive 1=active
gsr8,clm	Current Limit	√			number	0=inactive 1=active
gsr8,rif	Internal Fault	√			number	0=inactive 1=active
gsr8,rcf	Communication Fail	√			number	0=inactive 1=active
gsr8,rfn	Fan fail	√			number	0=inactive 1=active
gsr8,lsf	Load Share Fail	√			number	0=inactive 1=active

Converter Plant						
Related Commands						
Obj,attr	Description	Sta	Cha	Ope	Type	Range of Values
cp1,des	Description	√	√		Text	Converter Plant 1
cp1,typ	Converter output type	√			Text	24V or 48V
cp1,vdc	DC Voltage	√		√	Number	Number in volts
cp1,adc	DC Current	√			Number	Number in amps
cp1,cap	Installed capacity	√			Number	Number in amps
cp1,olcap	Online capacity	√			Number	Number in amps
cp1,vsp	Voltage Set-Point	√	√		Number	23-28V or 46-57V
cp1,vsd	Internal high voltage shutdown	√	√		Number	25-30V or 50-60V
cp1,dth	Low Voltage Discon Threshold	√	√		Number	20-25V or 40-50V
cp1,rth	Low Voltage Recon Threshold	√	√		Number	22-27V or 44-54V
cp1,lvd	Low Voltage Disconnect Enable	√	√		Number	0=disabled 1=enabled
cp1,rs	Converter restart	√		√	number	1=restart
cp1,rme	Redundancy monitor enable	√	√		number	0=disable,1=enable
Cp1,rof	Remote standby enable	√	√		number	0=disable,1=enable

⁶ s stands for shelf number (1 to 6)

r stands for rectifier number (1 to 7)

⁷ The user may only set the state to ON, STANDBY, or VACANT

DC Converter						
Related Commands						
Obj,attr	Description	Sta	Cha	Ope	Type	Range of Values
csr8,des	Description	√	√		Text	DC Converter sr8
csr8,typ	Type	√			Text	10 chars
csr8,sn	Serial number	√			Text	Serial number
csr8,adc	DC Current	√			Number	Number in amps
csr8,cap	Capacity	√			Number	Number in amps
csr8,slt	State	√		√	Text	ON9, OFF9, STANDBY9, MISSING, VACANT9 ON qualifiers –LIM OFF qualifiers –LVD, -INF, - TA, - HVSD, -FAN
csr8,cfa	Converter Fail	√			Number	0=inactive 1=active
csr8,did	ID Conflict	√			Number	0=inactive 1=active
csr8,ccf	Communication Fail	√			Number	0=inactive 1=active

BAR-Battery Reserve Management						
Related Commands						
Obj,attr	Description	Sta	Cha	Ope	Type	Range of Values
br1,des	Description	√	√		Text	Battery Reserve 1
br1,adc	Total battery current	√			number	d A (+ for discharge, - for charge)
br1,hbt	Highest battery temperature	√			number	dd °C
br1,lbt	Lowest battery temperature	√			number	dd °C
br1,cap	Installed battery capacity	√			number	dddddd AH
br1,olcap	On-line battery capacity	√			number	dddddd AH
br1,btr	Discharge test results	√			text	result, reserve, load result is one of the following: COMPLETED CHECK BATTERY INTERRUPTED ACTIVE NOT RUN reserve is hours calculate by last complete test load is load at beginning of test
br1,tth	High Temperature Threshold	√	√		Number	30-90°C or 86-194°C
br1,cle	Current Limit Enable	√	√		number	0=disable 1=enable
br1,clt	Current Limit Threshold	√	√		number	5-1000A
br1,cev	Battery string end of discharge V	√	√		Number	19.25-22.75V or 40.25-43.75V
br1,bts	Battery Test State	√		√	number	0=inactive 1=active
br1,mtt	Manual test type	√	√		text	DISABLED, 20%, TIMED
br1,tev	Manual test alarm voltage	√	√		number	21-27V or 36-48 V
br1,tmd	Manual test duration	√	√		number	0.1-99.9 hours

⁸s stands for shelf number (0 or 1)

r stands for converter number (1 thru 6)

⁹The user may only set the state to ON, STANDBY, or VACANT

BAR-Battery Reserve Management						
Related Commands						
Obj,attr	Description	Sta	Cha	Ope	Type	Range of Values
br1,bte	Auto test type	√	√		text	DISABLED, 20%, TIMED
br1,btv	Battery test rectifier voltage	√	√		number	21-26 V or 42-52 V
br1,ath	Auto test start hour	√	√		number	0-23
br1,tin	Auto test interval	√	√		number	1-18 months
br1,atw	Auto test min hours after BD	√	√		number	0-240 hours
br1,atd	Auto test date	√	√		date	dd-mmm-yy
br1,nvm	Number of mid-cell V present	√				d
br1,ntm	Number of temperatures present	√				d
br1,scd	Battery voltage imbalance detection enable	√			number	0=disable,1=enable (Automatically enabled when mid cell V monitorpresent)
br1,scv	Battery imbalance threshold	√	√		number	1.5-3.0V

BTD- Battery Type Definition						
Related Commands						
Obj,attr	Description	Sta	Cha	Ope	Type	Range of Values
btn ¹⁰ ,des	Description	√	√		Text	Battery Configuration n10
btn10,bty	Battery Type	√	√		Text	Up to 14 characters
btn10,btc	Battery Class	√	√		Text	FLOODED, SEALED, NICD,
btn10,cap	Capacity	√	√		Number	number

BST- Boost Management						
Related Commands						
Obj,attr	Description	Sta	Cha	Ope	Type	Range of Values
bs1,ide	Identifier	√			Text	BS1
bs1,des	Description	√	√		Text	Boost Control 1
bs1,slt	State	√	√		Text	QRCT, MANUAL, BTP, TIMED AU-TO, OFF
bs1,atm	Auto Mode	√	√		Text	OFF, QRCT, TIMED
bs1,tmd	Timed Manual Duration	√	√		Number	1-80 hours
bs1,amf	Auto Multiplication Factor	√	√		Number	0.1-9
bs1,cta	Current Term Current Thresh	√	√		Number	1-999A

¹⁰ n stands for battery type number (1 thru 25)

CNT- Disconnect Contactor Control						
Related Commands						
Obj,attr	Description	Sta	Cha	Ope	Type	Range of Values
cnx ¹¹ ,ide	Identifier	√			number	CN1, CN2, CN3, CN4
cnx11,des	Description	√	√		number	Contactor 1
cnx11,sts	Status	√		√	text	NONE, DISCON, CONNECT, FAILED
cnx11,ena	Control enable	√	√			0=disable,1=enable
cnx11,dth	Disconnect threshold Vmin in adaptive mode	√	√		number	39V to 50V
cnx11,dvx	Vmax in adaptive mode	√	√		number	39V to 50V
cnx11,din	Imin in adaptive mode	√	√		number	0A to 9999A
cnx11,dix	Imax in adaptive mode	√	√		number	0A to 9999A
cnx11,ddy	Disconnect maximum delay	√	√		time	00:00:00 to 04:59:59
cnx11,ddy	Disconnect delay	√	√		number	0-300 minutes
cnx11,dam	Disconnect automode	√	√		text	0="NONE" 1="VOLTAGE" 2="VOLTAGE+TIME"
cnx11,dtm	Disconnect remaining time	√	√		number	>0 means going to disconnect
cnx11,rth	Reconnect threshold	√	√		number	19.5-27V or 39-55V
cnx11,rddy	Reconnect delay	√	√		number	0-300 seconds
cnx11,ram	Reconnect automode	√	√		text	0="NONE" 1="VOLTAGE" 2="VOLTAGE+TIME"
cnx114,rtm	Reconnect remaining time	√			number	>0 means going to reconnect

DCM- Distribution Current Monitor						
Related Commands						
Obj,attr	Description	Sta	Cha	Ope	Type	Range of Values
dcmxx ¹² ,ide	Identifier	√			number	DCMC1 is the plant shunt DCM01-DCM08
dcmxx12,des	Description	√	√		number	Contactor 1
dcmxx12,sn	Serial Number	√			text	Serial number
dcmxx12,brc	Board Code	√			text	Board code
dcmxx12,sts	State	√			text	NONE MISSING PRESENT
dcmxx12,typ	Shunt Type	√	√		text	NONE LOAD BATTERY
dcmxx12,val	Reading	√			number	ddd.d Amps
dcmxx12,sha	Shunt amp rating	√	√		number	0-9999 Amps

¹¹ The contactors are identified as follows:

CN1 = Battery Disconnect (LVBD1)

CN2 = Load 1 Disconnect (LVLD1)

CN3 = Load 2 Disconnect (LVLD2)

CN4 = Load 3 Disconnect (LVLD3)

¹²The shunt type defaults are as follows: DCMC1 = Battery

DCM01 = Battery DCM02-DCM08 = Load

DCN- Distribution Contactor Interface						
Related Commands						
Obj,attr	Description	Sta	Cha	Ope	Type	Range of Values
dcnxx ¹³ ,ide	Identifier	√			number	DCN01-DCN06
dcnxx ¹³ ,des	Description	√	√		number	Contactor 1
dcnxx ¹³ ,sn	Serial Number	√			text	Serial number
dcnxx ¹³ ,brc	Board Code	√			text	Board code
dcnxx ¹³ ,stt	State	√			text	NONE MISSINGOPEN CLOSED
dcnxx ¹³ ,typ	Contactor interface type	√	√		text	NONE, CN1, CN2, CN3, or CN4

STC- Slope Thermal Compensation						
Related Commands						
Obj,attr	Description	Sta	Cha	Ope	Type	Range of Values
sc1,ide	Identifier	√			Text	SC1
sc1,des	Description	√	√		Text	Slope Thermal Comp
sc1,stt	State	√	√		number	0=disable 1=enable
sc1,rve	Raise Voltage Enable	√	√		number	0=disable 1=enable
sc1,fse	Probe Fail-Safe Enable	√	√		number	0=disable 1=enable
sc1,ltt	Lower Temperature Threshold	√	√		number	-5-20°C or 23-68°F
sc1,ntt	Nominal Temperature Threshold	√	√		number	15-30°C or 59-86°F
sc1,utt	Upper Temperature Threshold	√	√		number	30-55°C or 86-131°F
sc1,spt	Step Temperature	√	√		number	45-85°C or 113-185°F
sc1,lsp	Low temperature slope	√	√		number	1-10mV/°C per cell
sc1,usp	Upper temperature slope	√	√		number	1-10mV/°C per cell

¹³ The contactor interface type defaults are as follows:

DCN01 = CN1

DCN02 = CN2

DCN03 = CN3

DCN04-DCN08 = CN4

INP- Input Management						
Related Commands						
Obj,attr	Description	Sta	Cha	Ope	Type	Range of Values
inmnn ¹⁴ .ide	Identifier	√			number	m=module nn=input number Examples: IN001=input 1 on controller IN103=input 3 on module with ID1
inmnn ¹⁴ .des	Description	√			text	See table below
inmnn ¹⁴ .sn	Serial Number	√			text	Serial number
inmnn ¹⁴ .brc	Board Code	√			text	Board code
inmnn ¹⁴ .stt	Input state	√			text	0=not alarming 1=alarming
inmnn ¹⁴ .typ	Input alarm type	√	√		text	<p>"" – no alarm, for in006, thisvalue allows the input to be used for either group standby or PBT. Polarity is ignored.</p> <p>"FAN1" - drives FAN1 alarm "FAN2" – drives FAN2 alarm "FAJ1" – drives FAJ1 alarm "FAJ2" – drives FAJ2 alarm "OSA1" – drives OSA1 alarm "AMJ1" – drives AMJ1 alarm,</p> <p>not valid for NE872 or other LVD card inputs.</p> <p>"AUX1" – drives AUX1 alarm "AUX2" – drives AUX2 alarm "AUX3" – drives AUX3 alarm "AUX4" – drives AUX4 alarm "AUX5" – drives AUX5 alarm "AUX6" – drives AUX6 alarm "REMLVD" – Active signal</p> <p>opens battery contactors for built-in plant input, or for LVD inputs, it opens the contactor on the card where the signal is active.</p>
inmnn ¹⁴ .pol	Input alarming state	√	√		text	CLOSED, OPEN

¹⁴ m is the distribution interface module ID from 1 to 4 (0 for the controller)

nn is the input number from 01 to the number of inputs supported by the distribution interface module

Built-in plant inputs		
Object	Signal Name	Default Description
In001	BALM1	Fuse Alarm Major
In002	BALM2	Open String
In003	BALM3	Auxiliary 1
In004	BALM4	Auxiliary 2
In005	BALM5	Auxiliary 3
In006	BALM6	Auxiliary Major Alarm
In007	ALM1	Emergency power off
In008	ALM2	PBT/TR
In009	ALM3	Emergency power off
In010	ALM4	Auxiliary 4
In011	ALM5	Auxiliary 5
In012	ALM6	Auxiliary 6
In013	ALM7	Auxiliary 7
In014	ALM8	Auxiliary 8
In015	ALM9	Auxiliary 9

COM- Call-Out Manager						
Related Commands						
Obj,attr	Description	Sta	Cha	Ope	Type	Range of Values
cm1,des	Description	√	√		text	30 char (Call-Out Manager)
cm1,ngi	NAG Interval	√	√		Number	15 to 60 minutes

COP- Call-Out Phone Number						
Related Commands						
Obj,attr	Description	Sta	Cha	Ope	Type	Range of Values
x,des	Description	√	√		text	(Alternate) Call-Out Number
x,typ	Type	√	√		text	DATA, PAGER
x,phn	Phone Number	√	√		text	Digit () * # - , up to 25 characters
x,bdr	Connect Baudrate	√	√		Number	300, 1200, 2400, 4800,
x,dbt	Data Bits	√	√		Number	7, 8
x,pry	Parity	√	√		Text	O,E,N
x,sbt	Stop Bits	√	√		Number	1, 2
x,dly	Pager ID Delay	√	√		Number	0-9 seconds
x,pgr	Pager ID (Pin #)	√	√		Text	Digit () * # - , up to 25
x,msg	Pager Message	√	√		Text	up to 25 characters

When X is P1 , P2 , P3 , P4 , a1

COE- Call-Out Email Address						
Related Commands						
Obj,attr	Description	Sta	Cha	Ope	Type	Range of Values
x,ide	Identifier	√			text	E1, E2, E3, E4
x,des	Description	√	√		text	Email Address
x,adr	Address	√	√		text	40 characters
x,typ	Type	√	√		text	NORMAL , PAGER

Where X is E1- E4

SND- SNMP Destination						
Related Commands						
Obj,attr	Description	Sta	Cha	Ope	Type	Range of Values
x,ide	Identifier	√			text	S1, S2, S3, S4
x,des	Description	√	√		text	SNMP Trap Destination
x,ip	IP Address	√	√		text	d.d.d.d

Where x is S1 - S4

CS- Community String Destination						
Related Commands						
Obj,attr	Description	Sta	Cha	Ope	Type	Range of Values
csn,des	Description	√	√		text	30 characters
csn,str	Community string	√	√		text	20 characters
csn,ip	IP address to match	√	√		IP address	xxx.xxx.xxx.xxx (0.0.0.0 → no match required)
csn,ipm	IP address mask	√	√		IP address	xxx.xxx.xxx.xxx (255.255.255.255 → compare entire IP address)
csn,wre	Write enable	√	√		number	0=disable 1=enable SETs

PSO- Periodic Call-Out						
Related Commands						
Obj,attr	Description	Sta	Cha	Ope	Type	Range of Values
po1,des	Description	√	√		text	Periodic Call-Out 1
po1,phn	Phone Number	√	√		text	Digit () * # - , up to 25characters
po1,bdr	Connect Baudrate	√	√		Number	300, 1200, 2400, 4800, 9600, 14400
po1,dbt	Data Bits	√	√		Number	7, 8
po1,pry	Parity	√	√		Text	O,E,N
po1,sbt	Stop Bits	√	√		Number	1, 2
po1,int	Interval	√	√		Text	Sunday...Saturday, Daily, Monthly, Quarterly, Never
po1,tim	Time	√	√		Time	Hh:mm
po1,cl01-	Command Line 1-10	√			Text	X Up to 40 characters each

Where n is 1 - 4

MDM- Modem						
Related Commands						
Obj,attr	Description	Sta	Cha	Ope	Type	Range of Values
mp1,des	Description	√	√		Text	Modem Port 1
mp1,sts	State	√			Text	USER, SUPER-USER, ADMINISTRATOR, TLI, LOGOUT
mp1,bdr	Modem baud rate	√	√		text	2400,4800,9600
mp1,dbt	Data Bits	√	√		Number	7, 8
mp1,pry	Parity	√	√		text	O, E, N
mp1,sbt	Stop Bits	√	√		Number	1, 2
mp1,tmo	Time-Out	√	√		Number	0(disabled) – 45 minutes
mp1,hsh	Handshaking	√	√		text	NO, SW
mp1,nrg	Number of Rings Before Answer	√	√		number	2-15
mp1,wre	Write Enable	√	√		Number	0=disable 1=enable(HW,SW)
mp1,ins	Modem Initialization String	√	√		text	Up to 40 characters "" assigns the default string

LPT -Local RS-232 Port						
Related Commands						
Obj,attr	Description	Sta	Cha	Ope	Type	Range of Values
lp1,des	Description	√	√		text	Local Port 1
lp1,sts	State	√			text	USER, SUPER-USER, ADMINISTRATOR, TLI, LOGOUT
lp1,bdr	Baud Rate	√	√		text	AUTO, 300, 1200, 2400, 4800, 9600, 19200
lp1,dbt	Data Bits	√	√		Number	7, 8
lp1,pry	Parity	√	√		text	O, E, N
lp1,sbt	Stop Bits	√	√		Number	1, 2
lp1,tmo	Time-Out	√	√		Number	0(disabled) – 45 minutes
lp1,hsh	Handshaking	√	√		text	NO, HW, SW
lp1,app	Application	√	√		Text	TERMINAL, EVENT LOG (HW,SW)
lp1,wre	Write Enable	√	√		Number	0=disable 1=enable (HW,SW)
		√				

ATS- Alarm Test						
Related Commands						
Obj,attr	Description	Sta	Cha	Ope	Type	Range of Values
atl,des	Description	√	√		Text	Alarm Test 1
atl,stt	Alarm Test State	√		√	Number	0=inactive 1=active
atl,stg	Alarm Test Stage	√			text	PCR,PMJ,PMN,R1,R2,R3,R4,R5,R6,R7
atl,lte	Alarm Test Enable	√	√		Number	0=disable 1=enable(HW,SW)
atl,dur	Duration	√	√		Number	5-300 seconds
atl,pmj	Test Power Major	√	√		Number	0=no 1=yes
atl,pmn	Test Power Minor	√	√		Number	0=no 1=yes
atl,r1	Test Relay 1	√	√		Number	0=no 1=yes
atl,r2	Test Relay 2	√	√		Number	0=no 1=yes
atl,r3	Test Relay 3	√	√		Number	0=no 1=yes
atl,ets	Email Test	√		√	number	1=do test (sets and clears ATA1)
atl,ems	Email Results	√			text	
atl,bzi	Audio Test Duration	√	√		Number	5-300 seconds
atl,bzt	Audio Test State	√		√	Number	""=Stop Test, Local=local
atl,irt	Individual Relay Test State	√		√	Number	""=Stop Test, PCR,PMJ,PMN,R1,R2,R3,R4,R5,R6,R7

Alarm Cut-off						
Related Commands						
Obj,attr	Description	Sta	Cha	Ope	Type	Range of Values
aco,des	Description	√	√		Text	Alarm Cut-off 1
aco,stt	Alarm Cut-off State	√		√	Number	0=inactive 1=active
aco,cst	Critical Alarm Cut-off State	√			Number	0=inactive 1=active
aco,cae	Critical Alarm Cut-off Enable	√	√		Number	0=disable 1=enable
aco,cto	Critical Alarm Cut-off Time-Out	√	√		Number	1 to 8 hours
aco,jst	Major Alarm Cut-off State	√			Number	0=inactive 1=active
aco,jae	Major Alarm Cut-off Enable	√	√		Number	0=disable 1=enable
aco,jto	Major Alarm Cut-off Time-Out	√	√		Number	1 to 8 hours
aco,nst	Minor Alarm Cut-off State	√			Number	0=inactive 1=active
aco,nae	Minor Alarm Cut-off Enable	√	√		Number	0=disable 1=enable
aco,nto	Minor Alarm Cut-off Time-Out	√	√		Number	1 to 72 hours
aco,lbe	Local Buzzer Enable	√	√		Number	0=disable 1=enable

UDE- User Defined Events						
Related Commands						
Obj,attr	Description	Sta	Cha	Ope	Type	Range of Values
unnnn ¹⁵ ,des	Description	√	√		Text	30 char
unnnn ¹⁵ ,fds	Front Panel Description	√	√		text	see below
unnnn ¹⁵ ,ast	Alarm State	√			Number	0=inactive 1=active
unnnn ¹⁵ ,sev	Severity	√	√		Text	CRIT, MAJ, MIN, WRN, RO
unnnn ¹⁵ ,prg	Program Line	√	√		Text	60 char
unnnn ¹⁵ ,dur	Minimum Duration	√	√		Number	> 0 seconds
unnnn ¹⁵ ,lat	Latched	√	√		Number	0=no 1=yes
unnnn ¹⁵ ,led	LED	√	√		text	BD,AC,DC,""
unnnn ¹⁵ ,acc	Contact Closure	√	√		text	R1,R2,R3,R4,R5,R6,R7,""
unnnn ¹⁵ ,dly	Notify Delay	√	√		Number	0-540 seconds
unnnn ¹⁵ ,noo	Notify On Occur	√	√		Number	0=no 1=yes
unnnn ¹⁵ ,nor	Notify On Retire	√	√		Number	0=no 1=yes
unnnn ¹⁵ ,nag	NAG On Occur	√	√		Number	0=no 1=yes
unnnn ¹⁵ ,dst	Notify Destination	√	√		text	"," P1, P2, P3, P4, E1, E2, E3,E4, S1, S2, S3, S4

DRC-Derived Channels						
Related Commands						
Obj,attr	Description	Sta	Cha	Ope	Type	Range of Values
DRnn ¹⁶ ,des	Description	√	√		Text	30 char (Derived Chan nn)
DRnn ¹⁶ ,val	Value	√			Number	Number units
DRnn ¹⁶ ,prg	Program line	√	√		Text	60 char
DRnn ¹⁶ ,uni	Unit	√	√		Text	5 chars

TRS- Trend						
Related Commands						
Obj,attr	Description	Sta	Cha	Ope	Type	Range of Values
Obj,ide	Identifier	√				DCT1 for DC plant load CPT1 for DC converter load
dct1,des	Description	√	√		Text	DC1 Trend Statistics CP1 Trend Statistics
dct1,src	Source	√	√		Text	DC1 ADCCP1 ADC

TLM- TLI Manager						
Related Commands						
Obj,attr	Description	Sta	Cha	Ope	Type	Range of Values
t1m1,des	Description	√	√		text	30 char (TLI Manager)
t1m1,aue	Activate-User Enable	√	√		number	0=disable 1=enable
t1m1,cts	CTS Connect Detection	√	√		number	0=disable 1=enable
t1m1,dsr	DSR Connect Detection	√	√		number	0=disable 1=enable
T1m1,prt	Port	√	√		number	2020
T1m1,tmo	Timeout	√	√		number	0-60 minutes

¹⁵ nnnn = 1 thru 128

¹⁶ nn is from 01 thru 08

TL1- TL1 Object						
Related Commands						
Obj,attr	Description	Sta	Cha	Ope	Type	Range of Values
t1m1,des	Description	√	√		text	30 char (TL1 Manager)
t1m1,aue	Activate-User Enable	√	√		number	0=disable 1=enable
t1m1,cts	CTS Connect Detection	√	√		number	0=disable 1=enable
t1m1,dsr	DSR Connect Detection	√	√		number	0=disable 1=enable
T1m1,prt	Port	√	√		number	2020
T1m1,tmo	Timeout	√	√		number	0-60 minutes

CBS- Call-Back Security						
Related Commands						
Obj,attr	Description	Sta	Cha	Ope	Type	Range of Values
cb1,des	Description	√	√		text	Call-Back Security 1
cb1,stt	State	√	√		number	0=off 1=on
cb1,ph1-5	Call-Back Phone Number	√	√		Text	Digit () * # - , space
cb1,br1-5	Connect Baudrate	√	√		number	300, 1200, 2400, 4800, 9600, 14400

MSV- Mid-String Voltage						
Related Commands						
Obj,attr	Description	Sta	Cha	Ope	Type	Range of Values
msnc ¹⁸ ,des	Description	√	√		text	30 char (Mid-String Voltage Module n Channel c)
msnc ¹⁸ ,stt	State	√		√	text	None, Present, Missing
msnc ¹⁸ ,val	Value	√			Number	Mid-String voltage
msnc ¹⁸ ,did	Duplicate Id	√			Number	0=no 1=yes

¹⁷ n is the TL object number from 001 thru 128

¹⁸ n is the Mid-String module number from 1 to 7, and

c is the Mid-String channel number from 1 to 3

NET-Network Settings						
Related Commands						
Obj,attr	Description	Sta	Cha	Ope	Type	Range of Values
net1,des	Description	√	√		text	30 char (Mid-String Voltage Module n Channel c)
net1,ead	Ethernet (MAC) Address	√			text	hh:hh:hh:hh:hh:hh
net1,sor	DHCP server hardware override	√			number	0=off, 1=on
net1,dhcp	DHCP	√	√	√	number	0=static IP, 1=DHCP Client (OPE causes system reboot)
net1,ip	Static IP address	√	√		IP address	xxx.xxx.xxx.xxx (not used if DHCP enabled)
net1,sub	Static Subnet Mask	√	√		IP address	xxx.xxx.xxx.xxx (not used if DHCP enabled)
net1,gtwy	Static Gateway (Router) IP	√	√		IP address	xxx.xxx.xxx.xxx (not used if DHCP enabled)
net1,host	Hostname	√	√		text	
net1,wip	Working IP address	√				xxx.xxx.xxx.xxx (shows DHCP assigned or static IP address)
net1,dom	Static Domain Name	√	√		text	(not used if DHCP enabled)
net1,dns	Static DNS IP	√	√		IP address	xxx.xxx.xxx.xxx (not used if DHCP enabled)
net1,wre	Write Enable	√	√			0=disabled, 1=enabled
net1,tmo	Session Timeout	√	√			Minutes
net1,mrsv	Mail host IP	√	√		IP address	xxx.xxx.xxx.xxx (0.0.0.0 will force a DNS lookup of "mailhost")
net1,ntp	Network Time Server IP address	√	√		IP address	xxx.xxx.xxx.xxx (0.0.0.0 is disable)

ANET- Auxiliary Network Settings						
Related Commands						
Obj,attr	Description	Sta	Cha	Ope	Type	Range of Values
net2,des	Description	√	√		text	30 char (Mid-String Voltage Module n Channel c)
net2,ena	Enable	√	√		number	0=disable 1=enable
net2,ip	Static IP address	√	√		IP address	xxx.xxx.xxx.xxx (not used if DHCP enabled)
net2,sub	Static Subnet Mask	√	√		IP address	xxx.xxx.xxx.xxx (not used if DHCP enabled)
net2,gtwy	Static Gateway (Router) IP	√	√		IP address	xxx.xxx.xxx.xxx (not used if DHCP enabled)
net2,host	Hostname	√	√		text	
net2,dom	Static Domain Name	√	√		text	(not used if DHCP enabled)
net2,mrsv	Mail host IP	√	√		IP	xxx.xxx.xxx.xxx (0.0.0.0 willforce a DNS lookup of "mailhost")

net2 is currently only used by an attached Gateway Card in the NX400 system.

Additional T1.317 Commands and Samples

ala	Report Active Alarms
------------	-----------------------------

Syntax: ala

Description

This command reports all the active alarm conditions in the plant. One alarm message is listed per line in the report. The table below lists the default alarm messages. Note that if user changes the severity of the alarm, the corresponding change will show up in the alarm message. However, alarm conditions with the RO severity will not be displayed, the rec command, discussed later, should be used.

Alarm Message

- MAJ, Multiple Rectifier Fail
- MAJ, Multiple AC Fail
- MAJ, Battery On Discharge
- MAJ, High Voltage
- MAJ, Sense Fuse
- MAJ, Fuse Major
- MAJ, Auxiliary Major
- MAJ, Contactor 1 Open
- MAJ, Contactor 1 Fail
- MAJ, Major Communication Fail
- MAJ, High Battery Current Shutdown
- MAJ, Shorted Cell Detected
- MAJ, Imminent Low V Shutdown
- MAJ, Open String
- MIN, Rectifier Fail
- MIN, AC Fail
- MIN, Thermal Probe Fail
- MIN, Battery High Temp
- MIN, Rect Redundancy Loss
- MIN, High Battery Current
- MIN, Minor Communication Fail MIN, Circuit Pack Failure
- MIN, Mid-cell V Monitor Fail

If no alarms are active “NO ACTIVE ALARMS” is reported.

bye	Log - off
------------	------------------

Syntax: bye

Description

This command is used to terminate the session.

Cha	Change Value
------------	---------------------

Syntax: cha obj,attr=value
 where: obj,attr is an object-attribute pair. For example, ps1,sid.

Description

This command is used to change system configuration parameters. Examples are listed below to illustrate how this command works.

```
cha ps1,sid="My Plant"Change the site id to My Plant
cha p1,phn="123456789"Change the primary phone number to 123456789
```

You must be logged in as a super-user or administrator to use this command. "" are required for all IP addresses and associated descriptions.

Cle	Clear All Latched Events
------------	---------------------------------

Syntax: cle

Description

This command is used to clear latched events. These events include communication failures, missing rectifiers, missing thermal probes, missing voltage monitoring module, distribution fuses, and loss of redundancy alarm.

You must be logged in as a super-user to use this command.

his	Report Alarm History
------------	-----------------------------

Syntax: his

Description

Syntaxhis
 where: obj,attr is an object-attribute pair as defined in the following: sum dc1,adc- report plant load current statistics
 sum br1,hbt- report highest battery temperature statistics

his	Report Boost History
------------	-----------------------------

Syntax: his bs1,stt

Description

This command reports the boost history in the following format: sum bs1,stt

```
30-MAY-03,15:11:12,RESUMED,COMPLETED,78
```

```
30-MAY-03,12:03:34,AUTO,DISCHARGE,14
```

.

**

This report gives the start date, start time, start reason, stop reason, and boost duration in minutes. The start reasons are:

MANUALBoost initiated by user

AUTOBoost started automatically after a battery discharge RESUMEDBoost resumed after being suspended by a discharge

The stop reasons are:

COMPLETEDBoost completed normally TIMEOUTBoost timed out before completing

DISCHARGEBoost suspended because of a battery discharge CANCELED Boost canceled by user

ALARMBoost cancelled by an alarm condition

DISABLEDAuto boost cancelled by being disabled

His	Report BD History
-----	-------------------

Syntax: dc1,bod

Description

This command reports the battery discharge history in the following format: his dc1,bod

30-MAY-03,15:11:12,MANUAL,COMPLETED,118.3,23,

01-APR-03,03:11:12,BD,COMPLETED,118.3,26,130

12-FEB-03,12:00:02,PERIODIC,COMPLETED,120.9,27,135

.

**

This report gives the start date, start time, start reason, current at start of discharge, duration in minutes, and, if calculated, a reserve time prediction. The start reasons are:

MANUALDischarge test initiated by user PERIODICPeriodic discharge test BDNatural battery discharge

The stop reasons are:

COMPLETEDDischarge completed normally

TIMEOUTAuto discharge test timed out

DISABLEDAuto discharge test disabled ENDVDDischarge test hit end voltage

CANCELEDDischarge test canceled by user

Lis	List Rectifiers
------------	------------------------

Syntax: lis rec

Description

This command is used to list all the rectifiers in the system. The command will list all present and missing rectifiers. Missing rectifiers are rectifiers that have been removed from a shelf. The cle will clear missing rectifiers from the controller's memory and they will no longer be listed by this command. Return value for a system with 3 rectifiers on shelf 1 would look like the following:

- lis rec

G11

G12

G13

.

- _

Login	Log- in
--------------	----------------

Syntax: login "password"

where password is either the user, super-user or administrator password

Description

This command is used to log-in as a user, super-user or administrator. For example, if you are currently logged into the controller as a user but would like to change the site id you

must first use this command to log-in as a super-user. You must be logged in as an administrator in order to upgrade the software and change passwords.

Syntax: ope obj,attr=value

Ope	Operate a Control
------------	--------------------------

where: obj,attr is an object-attribute pair. For example, dc1,pbt.

Description

This command is used to operate a system control parameter. Examples are listed below to illustrate how this command works.

ope ps1,usl=1Update serial link

ope dc1,slt="boost"Place plant into boost mode

You must be logged in as a super-user to use this command.

pas	Change Passwords
------------	-------------------------

Syntax: pas t,"password","password"

where "t" is to change the user password, "s" to change the super-user password, and "a" to change the administrator password. password is the new password

Description

This command changes either the user or super-user password. You must be logged in as a super-user to use this command. The password is sent twice in order to avoid mistakes.

The password must have at least 6 characters but no more than 15 characters.

You must be logged in as a super-user to use this command.

sta	Report Status
------------	----------------------

Syntax: sta obj,attr

where: obj,attr is an object-attribute pair. For example, ps1,sid.

Description

This command reports the value of the measurement, configuration, or control parameters in the system. A couple examples are listed below to illustrate how this command works.

sta dc1,vdcReport plant voltage

sta dc1,adcReport plant load current

The command line would respond as follows for first command listed above.

```
* sta dc1,vdc
```

```
:DC1
```

```
VDC=-52.48
```

```
.
```

```
* _
```

The "*" in the example above is the user command line prompt. The line ":DC1" indicates that the information that follows is for the plant object. The line starting with "VDC"

identifies the DC voltage. The "." line is the end-of-command identifier.

sum	Report Statistics
------------	--------------------------

Syntax: sum obj,attr

 where: obj,attr is an object-attribute pair defined by the following:

 sum dc1,adcReport plant load current statistics

 sum br1,hbtReport highest battery temperature statistics

 sum br1,amtReport ambient temperature statistics

Description

This command reports the highest hourly averages, highest hourly maximum, and the highest hourly minimum statistics for plant load and highest battery temperature. The following is an example of a command response:

```
* sum dc1,adc
:DC1 ADC HHI=
30-MAY-03,12:03:00,127.3
14-FEB-03,11:15:37,126.9
24-DEC-03,02:30:13,126.2
LHI=
29-MAR-03,10:43:00,120.0
04-APR-03,11:15:53,121.1
21-SEP-03,07:13:10,124.3
HHA=
03-JAN-03,12:00:00,127.0
18-APR-03,11:00:00,126.5
21-OCT-03,02:00:00,126.1
.
*
```

The line “:DC1 ADC” indicates that the information that follows is for the plant load current. The “HHI=” indicates highest hourly instantaneous reading. The “LHI=” indicates highest hourly instantaneous reading. The “HHA=” indicates highest hourly average reading. The “.” line is the end-of-command identifier. The “*” in the example above is the user command

line prompt.

sum	Report Plant Load Trend Statistics
------------	---

Syntax: sum dct1

Description

This command reports the plant trend statistics, which includes up to 16 daily highest hourly and lowest hourly instantaneous readings, up to 32 daily maximum hourly averages, and up to 13 monthly averages of the daily maximum hourly averages. The following is an example of a command response:

```
* sum dct1
:DCT1 SRC=DC1 ADC
CLR=01-JAN-2001,12:00:00 DHI=
29-JAN-2002,02:00:00,123.2
30-JAN-2003,05:00:00,120.1
31-JAN-2003,14:00:00,122.8 DLI=
29-JAN-2002,12:00:00,120.9
30-JAN-2003,08:00:00,118.7
31-JAN-2003,01:00:00,119.2 DHH=
29-JAN-2002,02:00:00,122.1
30-JAN-2003,05:00:00,119.7
31-JAN-2003,14:00:00,121.6 MAV=
31-JAN-2003,23:00:00,121.3
.
*
```

The “DHI=” indicates daily highest hourly instantaneous reading. The “DLI=” indicates daily highest hourly instantaneous reading. The “DHH=” indicates daily highest hourly average reading. The “MAV=” indicates monthly average of daily highest hourly average reading.

The “.” line is the end-of-command identifier. The “*” in the example above is the user command line prompt.

sum	Report Battery Discharge Statistics (profile)
------------	--

Syntax: sum dc1,bod

Description

This command reports the last battery discharge profile report. The report includes cleared date and time, start date and time, end date and time, duration in seconds, and up to 50 sample points. Each sample is time stamped in seconds. We compress the samples to derive a minimum set of data required to reconstruct the curve while retaining important coup de fouet minimum and maximum voltages and lowest voltage at end of discharge.

The following is an example of a command response:

```
* sum dc1,bod
:DC1 BOD
CLR=29-JUN-04,10:27:11 BEG=30-JUN-04,10:38:36 END=30-JUN-04,10:42:53 DUR=256
VAL= 0,51.08
8,50.18
18,49.24
20,48.87
248,48.36
252,49.76
254,50.84
256,51.13
.
*
```

The “.” line is the end-of-command identifier. The “*” in the example above is the user command line prompt.

GUI	Report GUI Compatibility
------------	---------------------------------

Syntax: GUI

Description

This command is for internal use only. It reports an EasyView compatibility number. The command response is:
841GUI=1.0

Ali	Special Internet Command
------------	---------------------------------

Syntax: ali

Description

This command is for internal use only. It exists for EasyView compatibility purposes only and does nothing.

Error Messages

While logging into the Pulsar Edge controller or while entering commands, you may encounter one or more of the following error messages:

Error Message	Description
!-112, SYNTAX ERROR	Unrecognizable command was entered.
!-220, SECURITY	Super-user command was entered by someone with user status.
!-221, EXCESSIVE LOGIN ATTEMPTS	Too many attempts were made to login with an unrecognized password.
!-223, INVALID PASSWORD	New password contains an illegal character.
!-224, NEW PASSWORD MISMATCH	First and second copy of new passwords don't match
!-304, INVALID PARAMETER	An attempt was made to change a parameter to an illegal value.
!-319, INVALID ATTRIBUTE	An invalid object id was specified in the command or, a command referred to an attribute that doesn't support
!-320, INVALID OBJECT	An invalid object id was specified in the command
!328, FEATURE DISABLED	An attempt was made to initiate a feature that is disabled.
!335, COULD NOT EXECUTE	Command could not execute because of active alarms or a conflicting operation.

This page intentionally left blank

Appendix C: Battery Functions

Float Mode

Float mode is the default operation mode of the power system. The system voltage, while in float mode, is determined by the configuration parameter Rectifier Float Set point (fsp) and may be adjusted by the Battery Thermal Compensation circuit, if active. No individual adjustment of plant rectifiers is necessary and load sharing among plant rectifiers is automatic in all plant modes and will take effect within several seconds of a new rectifier being added to the system.

The Rectifier Float Set point should be set per the battery manufacturer's recommendations. Note that the actual Rectifier Float Set point measured on the plant may differ from the value set by the user if battery thermal compensation (STC) is enabled.

Slope Thermal Compensation

The Pulsar Edge has a flexible battery Thermal Compensation feature which provides voltage compensation from that level established by the Plant Float Set-Point (fsp) or Boost Set-Point (bsp), dependent on the highest temperature monitored by the QS873A VT-Probes attached to the system batteries. Thermal Compensation can lower or raise the system bus voltage from the Float Set Point voltage. For monitored battery temperatures above an ideal battery temperature the controller can lower the system voltage per programmed linear curve. Lowering the plant voltage helps keep the batteries at their optimum state of charge while protecting them from thermal runaway. For monitored battery temperatures lower than the ideal battery temperature the controller can raise the system voltage per programmed linear curve. Raising the system voltage helps keep the batteries at their optimum state of charge.

Increasing the system voltage with decreases in battery temperature also causes more current to flow into the batteries which results in electrolysis of the water in the batteries. This reaction is exothermic and also serves to keep batteries warm. Thermal Compensation is generally used in systems utilizing sealed or valve-regulated maintenance free batteries. Thermal Compensation is automatically enabled from the factory when Valve-Regulated Lead Acid batteries are the system battery type.

Thermal runaway is a complex sealed battery phenomenon where, for one or more of a number of reasons, one or more cells in a string may be unable to dissipate the internal heat generated by their charging current and as a result will experience an increase in internal temperature. By having the controller lower the float voltage as the battery temperature increases, system tries to keep the float current lower to a point where destructive battery behavior can be avoided. If cell failure is imminent and the battery temperature continues to rise above the threshold configured for Battery Thermal Voltage Step Down Temperature, the controller has a feature that will force the system DC bus voltage to drop in a single step to a level which should keep the remaining cells in the string from overcharging and being damaged. The following figure provides a graphical view of the Pulsar Edge's Battery Thermal Compensation feature and the relationship of its various set points.

The following describes the configuration parameters which may be Enabled/Disabled and configured by the user. Refer to Appendix D for the ranges of values the parameters may take and their factory default settings.

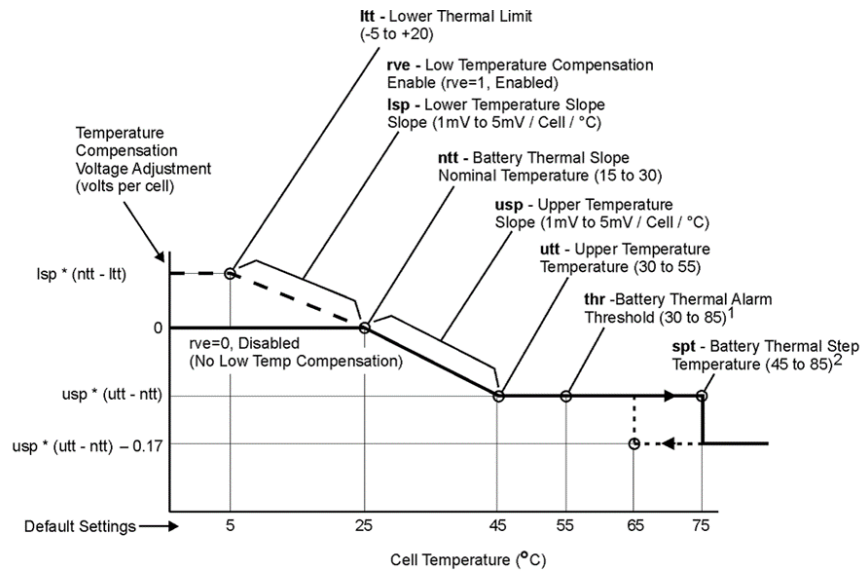

1. The Battery Thermal Alarm occurs when the temperature rises above the thr set point. It retires when the temperature decreases to 10°C below the thr set point (45°C default).
2. Plant voltage decreases an additional 0.17 volts per cell when the temperature increases above the spt set point. It is increased 0.17 volts per cell when the temperature decreases to 10°C below the spt set point, as indicated by the dashed line (65°C default).

Figure 26 Slope Thermal Compensation

Temperature Alarms

The Pulsar Edge has several alarm thresholds that can be set based on temperature.

- **High Temperature Alarm:** The High Battery Thermal Alarm Threshold (thr) is the monitored battery temperature at which above this threshold results in a High Battery Thermal alarm. This alarm threshold can be set from 30°C to 85°C and its severity is configurable. The alarm retires when the temperature drops to 10°C below the set threshold. The factory default setting is 55°C with Power Minor severity.
- **Very High Temperature Alarm:** The Very High Battery Thermal Alarm Threshold is a second alarm threshold available for high battery temperature. The monitored battery temperature at which above this threshold results in a Very High Battery Thermal alarm. This alarm threshold can be set from 30°C to 85°C and its severity is configurable. The alarm retires when the temperature drops to 10°C below the set threshold. The factory default setting is TBD°C with Power Major severity.
- **Low Temperature Alarm:** The Low Battery Thermal Alarm Threshold is the monitored battery temperature at which below this threshold results in a Low Battery Thermal alarm. This alarm threshold can be set from -40°C to 10°C and its severity is configurable. The alarm retires when the temperature raises 10°C above the set threshold. The factory default setting is TBD°C with Power Minor severity.
- **Very Low Temperature Alarm:** The Very Low Battery Thermal Alarm Threshold is a second alarm threshold available for low battery temperature. The monitored battery temperature at which below this threshold will result in a Very Low Battery Thermal alarm. This alarm threshold can be set from 40°C to 10°C and its severity is configurable. The alarm retires when the temperature raises 10°C above the set threshold. The factory default setting is TBD°C with Power Major severity.

High Temperature Compensation

The Slope Thermal Compensation feature of the controller must be Enabled for this feature to operate. The controller will automatically detect and obtain temperature measurements from an attached QS873 thermal probe. However, it does not automatically enable thermal compensation. A user must configure the controller to Disable the Slope Thermal Compensation feature. Disconnecting thermal probes will result in thermal probe failures. This alarm can be removed by issuing the Uninstall Equipment operation through the Craft port or remote interfaces. Note: if STC is Enabled, removing all thermal probes and issuing the Uninstall Equipment will still result in a Thermal Probe fail alarm. STC must be Disabled to remove the alarm.

- **V Step Down:** The High Temperature Voltage Step Down Temperature threshold, shown as spt, is the temperature at which the system controller will adjust the rectifiers to set the DC bus voltage down by another.17V per cell. This battery step down temperature can be set from 45°C to 85°C. A 10°C hysteresis is built into this feature. The factory default setting is 75°C.
- **High Comp Limit:** The High Temperature Compensation Limit, shown as utt, is the upper temperature thermal limit at which high temperature thermal compensation is stopped and the system DC voltage is no longer decreased according to the configured linear slope rate. This temperature threshold limit can be set from 30°C to 55°C. The factory default setting is 45°C.
- **Decrease:** The high temperature decrease rate, shown as usp, establishes the linear slope rate that the controller utilizes to decrease the system DC voltage from the configured nominal temperature value to the High Temperature Compensation Limit. The high temperature slope setting (rate of decrease) can be set from -1mV to -10mV/°C per cell in -.1mV/°C per cell steps. The factory default is -3mV/°C per cell.
- **Nominal Temperature:** The nominal temperature, shown as ntt, is the battery temperature which there is no battery voltage compensation. Slope Thermal Compensation will be active if the feature is enabled for temperatures above or below this temperature threshold. The nominal battery temperature range is from 15° to 30°C. The factory default setting is 25°C.

Low Temperature Compensation

The battery Low Temperature compensation is a separate component of the overall controller's thermal compensation feature. Low Temperature compensation is Disabled by default, and can be enabled only if Temperature Slope Thermal Compensation is enabled. The following are its associated parameters.

- **Low Temperature Compensation Enable:** The Low Temperature Compensation Enable/Disable, shown as rve, allows the feature to be active or disabled independently from High Temperature compensation.
- **Low Comp Limit:** The Low Temperature Thermal Compensation Limit, shown as (lvt), is the lower temperature thermal limit at which low temperature thermal compensation is stopped and the system DC voltage is no longer increased according to the configured linear slope rate. This temperature threshold limit can be set from -5°C to 20°C. The factory default setting is 0°C.
- **Increase:** The low temperature slope increase rate, shown as lsp, establishes the linear slope rate that the controller utilizes to increase the system DC voltage from the configured Battery Nominal Temperature value to the Low Temperature Compensation Temperature Limit. The low temperature slope setting (rate of increase) can be set from 1mV to 10mV/°C per cell in .1mV/°C per cell increments. The factory default setting is 3mV/°C per cell.

Plant Battery Test

The following is a list of plant battery test parameters that can be configured in the controller. The result of the Plant Battery Test is available in the Batteries sub-menu of the Status menu.

Manual Test: Permits manually starting a battery discharge test. The test can be set to end on either of the following two parameters.

- **Timed Duration:** The duration of the test can be set from 0.1 hours to 99.9 hours and is correlated with a system DC bus alarm voltage. Test is successful when the voltage is not reached in the time period set.
- **20% of Capacity Algorithm:** Utilizes a patented algorithm that places the system on discharge and looks for the Coup de fouet in the discharge curve and runs the discharge for a time equal to about 20% of the system reserve capacity and calculates the remainder.
- **Amp-Hours Out:** The test can be set to end when configured Amp-Hours to be removed has been reached. This test is also bound by the test duration timed parameter.

Automatic Test: This utility offers the flexibility of running pre-programmed battery tests at specific times and days, and for specific durations.

- **Automatic Test:** Select Disabled, 20% of capacity, Timed, or Amp-Hours for the automatic Test Type for the battery test. The factory default setting is disabled.
- **Months Between Test Interval:** The test interval (time between tests) can be set from 1 to 18 months in 1 month increments. The factory default setting is 12 months.
- **Test Date for Next Test:** Enter a particular day in configured format to automatically run the battery test on that day.
- **Test Start at Hour:** Enter a particular time in hh format to automatically run the battery test at that time. The setting can be configured from 0 to 23 hours. 00:00 is midnight.
- **Delay Test Hours After BD:** Time interval needed to elapse since the last Battery on Discharge alarm before a battery test can be performed. This can be set from 0 to 240 hours in 1 hour increments. The factory default setting is 72 hours.

Recharge Amp Limit: This section contains the settings for battery recharge current limit.

- **Limit:** Enable or disable battery discharge current limiting.
- **Limit To:** Current limit setting, from 0.5A to 1000A. The factory default setting is 25A.

During this test, the controller lowers the rectifier voltage to the rectifier voltage during test threshold or 1.2V (0.6V for 24V systems) higher than highest configured LVD threshold when LVDs are present. The set-point value of 1.2V plus the highest possible LVD contactor disconnect threshold allows the controller to enact a safe DC bus voltage as not to accidentally open any of the LVD contactors. Lowering the rectifier output voltage to rectifier voltage during test threshold or the LVD safe voltage should create a battery on discharge condition. If the batteries are present and healthy, the plant voltage will remain above 48V/24V and the batteries will support the load. If the batteries are not present or are not able to support the load, the plant voltage will immediately drop to approximately rectifier voltage during test threshold without any consequence to the load. The Battery on Discharge alarm is masked during this test.

The test is terminated by the occurrence of any of the following conditions:

- Initiating another Plant Battery Test. That is, once the test has been initiated, the test may be stopped by initiating another test either through the controller.
- An alarm condition occurring. Any alarm condition that occurs during this test will result in the test being aborted. The test will be aborted even if there is a contact-closure still present on the PBT inputs.
- The test has continued for over 100 minutes.
- The plant voltage has dropped below 44V or the LVD safe voltage. In this case, the system will abort the test and resume rectifier operation.

After the test has stopped, the plant will revert to the float mode. It may go to boost mode if the auto-boost feature has been enabled.

Boost Mode

Boost charging is a feature of the Pulsar Edge controller, which allows the user to temporarily raise the plant voltage to a higher predetermined level to reduce the time needed to charge batteries. The system may manually be placed in the boost-mode through the front panel.

Note that the measured boost voltage may not exactly match the value chosen by the user if the thermal compensation feature is enabled. This is because the Pulsar Edge performs thermal compensated boost charging and will adjust the boost value based on the battery temperature per the slope chosen by the user.

The plant will exit the boost mode and enter the float mode if any of the following occurs:

- The current flowing into the battery string(s) is less than the configured current threshold for at least 3 minutes.
- The duration of boost mode charging has reached the configured number of hours
- The controller receives either a Vsense Fail, Communication Fail, High-Voltage, Rectifier Fail alarm, Major Fuse Alarm, or High-Battery Temperature alarms
- User sets the plant state to Float via the Craft port or remote interface.

Once initiated, the boost mode may be exited by placing the Plant State to Float.

Auto-Boost Charge

This feature may be enabled from the Craft port or remote interface. See Appendix B for details. When enabled, the plant enters the boost-charging mode of operation following a battery discharge once the BD alarm has been retired, provided the duration of the discharge was greater than 4 minutes. The controller will not enter the auto-boost-charging mode if the discharge duration was less than 4 minutes. When in auto-boost mode, the controller raises the plant voltage to the value selected by the user. The controller keeps the plant in this mode of operation for a minimum of 5 minutes. The exit conditions for the Auto-Boost Charge are the same as those for Boost Charge.

Redundancy Loss Function

This feature must be enabled from the Craft port or remote interface. The controller determines the number of rectifiers present and compares the actual currents being drawn by the load to that produced by the total number of rectifiers less one or the configured value for the desired redundancy. If the measured load current exceeds the N (or adjusted) rectifier's capacity for over 1 min, the alarm condition is activated. The alarm condition is latched on until the Clear Events command is activated from the front panel.

This feature may be used by customers to determine if the load being served is greater than N rectifiers worth, in an N+1 system. That is, the load requirements have changed such that the power system is no longer operating as a redundant power system. An additional rectifier may be required to ensure continuous redundant operation. More rectifiers may be required if more than N+1 redundancy is configured and required.

If enabled, this feature will be disabled during battery discharge and recharge conditions. It will be enabled when the battery charging current falls below 5A.

Battery Voltage Imbalance Detection

This feature requires the use of the ES771A Remote Voltage Monitoring Module. Note that this feature is automatically enabled if the controller detects the presence of the ES771A module. This module is to be placed in the electronics cabinet and utilizes the QS873A VT-Probes to measure the mid-string voltage of the particular battery string being monitored. The VT-Probe is to be placed on the negative battery terminal of the battery located in the middle of the battery string. The Pulsar Edge controller has data on the system DC bus voltage. The half-string voltage measurement obtained from the ES771 monitoring the battery string is compared to the system DC bus voltage minus the value of the half-string voltage measurement. If the comparison results in a difference of greater than 1.7V or the value configured for this threshold for longer than 12 hours, the alarm is asserted. The alarm may be retired by initiating the Clear Events command.

After this feature has been enabled, the system waits for 12 hours to ensure the battery strings are stable. A battery string is considered to be stable if the charging current is less than 3A. If a stable battery string yields a difference measurement greater than 1.7V or the value configured for this threshold for over 12 continuous hours, a Battery Voltage Imbalance alarm is generated.

When the alarm is issued, the Float Set-Point (fsp) and the Battery On Discharge (BD) threshold values are reduced by $\text{fsp}/\text{Number of Cells per string}$. Thus, for an $\text{fsp}=54.5$ the system DC bus voltage would be reduced by $54.5/24$ or approximately 2.27V. Once the alarm has been cleared by the Clear Events (CLE) command, the plant reverts to its normal fsp; however, the BD threshold is maintained at the new threshold for up to four minutes before reverting back to the old threshold. This is done to ensure the batteries have had enough time to charge up to the nominal fsp and to prevent any spurious BD alarm conditions.

This feature may be used by customers as part of their overall battery maintenance program in determining the health of battery strings. A voltage imbalance of 1.7V or the value configured for this threshold between half-string voltages may mean a shorted-cell exists somewhere in the string. A service person can be sent out to the site and determine if the string is bad and should be replaced.

Battery Recharge Current Limit

The battery recharge current limit feature enables the Pulsar Edge controller to limit the recharge current flowing into a battery section during the charge cycle. The recharge current flowing into the battery section can be limited to any value between 5A and 1000A.

Note that this feature will not have any impact on the current being delivered to the load. Further, there will be no effect on the discharge current flowing from the battery strings to the load during an ac fail condition. The controller will try and maintain the recharge current to within 10% of the set level.

Battery Parameter Defaults

The Pulsar Edge controller has been configured with battery specific defaults. These battery types are shown in the top portion of Table 5. The generic Valve-Regulated Lead Acid battery is the default battery type for this controller configuration. Battery models and their parameters can be added or adjusted in the field.

Battery Type	String Or Battery Capacity (AH)
M12V90FT	90
M12V105FT	104
M12V155FT	155
NCX-125	125
NCX-80	80
NSB110FT	111
NSB170FT	168
NSB60FT	60
SBS-145	148
SBS-170	170
TEL12-90	88
TEL12-105	100
XE60	59.3
12A100FT	96
12A150FT	145
12AVR145	145
12FAT130	127
12FAT155	155
12IR150/150LP	145
IR40EC	35
Generic Listings	String Or Battery Capacity (AH)
Valve-Reg (VRLA)	0
Flooded	0
Ni-Cd	0
Li-LMP	63
Li-ELITE	63

Table 5 Supported Battery Types

This page intentionally left blank

Appendix D: Default Configurations

Table 6 through Table 9 provide the default settings for the configurable parameters and features that are associated in the Pulsar Edge. Also listed are the battery technologies and specific battery models included in the configuration file previously shown in Appendix C. Specific battery models assume the configuration defaults for their generic technology class except for a specific capacity and model name. The generic Valve Regulated Lead Acid battery type will be the factory default Battery Type selected and configured for the Pulsar Edge configuration. Changes to individual features, parameters, and thresholds for each battery type will be allowed in the field. These changes will be stored in non-volatile memory. However, if the Load Factory Defaults control/operation command is initiated, all assigned values shown in Table 5 and Table 6 through Table 9 will be restored. The configurations made in the field will be lost unless they were backed-up.

There are five sections for determining the defaults for the standard configuration program file. These sections are **Standard, 48V Battery, 24V Battery, Converters, and Alarms**. This document will show four separate tables for these categories. In addition, the Excel spreadsheet is also attached.

The **Standard** section includes settings and thresholds independent of the primary output voltage of the system. Generally, these items are set using information that does not depend on the battery reserve system.

The **48V Battery** section includes settings and thresholds that are generally dependent of the primary 48V output voltage of the system. Generally, these items are set using information that depends on the battery reserve system configured.

The **24V Battery** section includes settings and thresholds that are generally dependent of the primary 24V output voltage of the system. Generally, these items are set using information that depends on the battery reserve system configured.

The **Converters** section contains the settings and thresholds associated with DC/DC converters and converter systems.

The **Alarms** section provides the assigned severities, alarm output relays (if present), and LED assignments for the standard configuration.

This document will continue to be revised and updated as feedback and additional requirements come in from the field or as new configurable features and thresholds are added to the standard Pulsar Edge.

Features, thresholds, and other configurable items not addressed in the list will remain at the factory default set for each respective item as defined in the standard product offering. Note: Custom configurations can be made available through configuration of application or customer preferred defaults for the information in the following tables for certain application.

Category	Description	Range	Factory Default	Factory 24V Rectifier Default	Factory 48V Rectifier Default	obj,attr
			Factory	Factory 24V	Factory 48V	
Battery Type Definitions	Battery 1 Type Description	<=32 chars	"Generic Valve-Reg Battery"			BT01,DES
	Battery 1 Type		"Valve-Reg"			BT01,BTY
	Battery 1 Class		"VALVE-REG"			BT01,BTC
	Battery 1 Capacity		0			BT01,CAP
	Battery 2 Type Description	<=32 chars	"Generic Flooded Battery"			BT02,DES
	Battery 2 Type		"Flooded"			BT02,BTY
	Battery 2 Class		"FLOODED"			BT02,BTC
	Battery 2 Capacity		0			BT02,CAP
	Battery 3 Type Description	<=32 chars	"Generic NiCd Battery"			BT03,DES
	Battery 3 Type		"NiCd"			BT03,BTY
	Battery3 Class		"NICD"			BT03,BTC
	Battery 3 Capacity		0			BT03,CAP
	Battery 4 Type Description	<=32 chars	"Generic Li-LMP Battery"			BT04,DES
	Battery 4 Type		"Li-LMP"			BT04,BTY
	Battery 4 Class		"LI-LMP"			BT04,BTC
	Battery 4 Capacity		63			BT04,CAP
	Battery 5 Type Description	<=32 chars	"Generic Li-ELITE Battery"			BT05,DES
	Battery 5 Type		"Li-ELITE"			BT05,BTY
	Battery 5 Class		"LI-ELITE"			BT05,BTC
	Battery 5 Capacity		63			BT05,CAP
	Battery 6 Type Description	<=32 chars	"Lineage Power (408014140)"			BT06,DES
	Battery 6 Type		"12A100FT"			BT06,BTY
	Battery 6 Class		"VALVE-REG"			BT06,BTC
	Battery 6 Capacity		96			BT06,CAP
	Battery 7 Type Description	<=32 chars	"Lineage Power (408520655)"			BT07,DES
	Battery 7 Type		"12A150FT"			BT07,BTY
	Battery 7 Class		"VALVE-REG"			BT07,BTC
Battery 7 Capacity		145			BT07,CAP	
Battery 8 Type Description	<=32 chars	"East Penn (CC408641914)"			BT08,DES	
Battery 8 Type		"12AVR145"			BT08,BTY	
Battery 8 Class		"VALVE-REG"			BT08,BTC	
Battery 8 Capacity		145			BT08,CAP	
Battery 9 Type Description	<=32 chars	"FIAMM (408538160)"			BT09,DES	
Battery 9 Type		"12FAT130"			BT09,BTY	
Battery 9 Class		"VALVE-REG"			BT09,BTC	

Table 6: Standard Configuration Items

Category	Description	Range	Factory Default	Factory 24V Rectifier Default	Factory 48V Rectifier Default	obj,attr
			Factory	Factory 24V	Factory 48V	
Battery Type Definitions	Battery 9 Capacity		127			BT09,CAP
	Battery 10 Type Description	<=32 chars	"FIAMM (408565650)"			BT10,DES
	Battery 10 Type		"12FAT155"			BT10,BTY
	Battery 10 Class		"VALVE-REG"			BT10,BTC
	Battery 10 Capacity		155			BT10,CAP
	Battery 11 Type Description	<=32 chars	"Lineage Power (408520663)"			BT11,DES
	Battery 11 Type		"12IR150/150LP"			BT11,BTY
	Battery 11 Class		"VALVE-REG"			BT11,BTC
	Battery 11 Capacity		145			BT11,CAP
	Battery 12 Type Description	<=32 chars	"Lineage Power (407928753)"			BT12,DES
	Battery 12 Type		"IR40EC"			BT12,BTY
	Battery 12 Class		"VALVE-REG"			BT12,BTC
	Battery 12 Capacity		35			BT12,CAP
	Battery 13 Type Description	<=32 chars	"GNB-EXIDE (408406023)"			BT13,DES
	Battery 13 Type		"M12V105FT"			BT13,BTY
	Battery 13 Class		"VALVE-REG"			BT13,BTC
	Battery 13 Capacity		104			BT13,CAP
	Battery 14 Type Description	<=32 chars	"GNB-EXIDE (408496156)"			BT14,DES
	Battery 14 Type		"M12V155FT"			BT14,BTY
	Battery 14 Class		"VALVE-REG"			BT14,BTC
	Battery 14 Capacity		155			BT14,CAP
	Battery 15 Type Description	<=32 chars	"GNB-EXIDE (407791185)"			BT15,DES
	Battery 15 Type		"M12V90FT"			BT15,BTY
	Battery 15 Class		"VALVE-REG"			BT15,BTC
	Battery 15 Capacity		90			BT15,CAP
	Battery 16 Type Description	<=32 chars	"Saft ()"			BT16,DES
	Battery 16 Type		"NCX-125"			BT16,BTY
	Battery 16 Class		"NICD"			BT16,BTC
	Battery 16 Capacity		125			BT16,CAP
	Battery 17 Type Description	<=32 chars	"Saft (408539365)"			BT17,DES
	Battery 17 Type		"NCX-80"			BT17,BTY
	Battery 17 Class		"NICD"			BT17,BTC
Battery 17 Capacity		80			BT17,CAP	
Battery 18 Type Description	<=32 chars	"North Star (408508752)"			BT18,DES	
Battery 18 Type		"NSB110FT"			BT18,BTY	
Battery 18 Class		"VALVE-REG"			BT18,BTC	
Battery 18 Capacity		111			BT18,CAP	

Table 6: Standard Configuration Items

Category	Description	Range	Factory Default	Factory 24V Rectifier Default	Factory 48V Rectifier Default	obj,attr
			Factory	Factory 24V	Factory 48V	
Battery Type Definitions	Battery 19 Type Description	<=32 chars	"North Star (408508760)"			BT19,DES
	Battery 19 Type		"NSB170FT"			BT19,BTY
	Battery 19 Class		"VALVE-REG"			BT19,BTC
	Battery 19 Capacity		168			BT19,CAP
	Battery 20 Type Description	<=32 chars	"North Star (408503910)"			BT20,DES
	Battery 20 Type		"NSB60FT"			BT20,BTY
	Battery 20 Class		"VALVE-REG"			BT20,BTC
	Battery 20 Capacity		60			BT20,CAP
	Battery 21 Type Description	<=32 chars	"Energys (CC408616131)"			BT21,DES
	Battery 21 Type		"SBS145"			BT21,BTY
	Battery 21 Class		"VALVE-REG"			BT21,BTC
	Battery 21 Capacity		148			BT21,CAP
	Battery 22 Type Description	<=32 chars	"Energys (CC408619852)"			BT22,DES
	Battery 22 Type		"SBS170"			BT22,BTY
	Battery 22 Class		"VALVE-REG"			BT22,BTC
	Battery 22 Capacity		170			BT22,CAP
	Battery 23 Type Description	<=32 chars	"C&D (408530167)"			BT23,DES
	Battery 23 Type		"TEL12-105F"			BT23,BTY
	Battery 23 Class		"VALVE-REG"			BT23,BTC
	Battery 23 Capacity		100			BT23,CAP
Battery 24 Type Description	<=32 chars	"C&D (CC408634216)"			BT24,DES	
Battery 24 Type		"TEL12-90"			BT24,BTY	
Battery 24 Class		"VALVE-REG"			BT24,BTC	
Battery 24 Capacity		88			BT24,CAP	
Battery 25 Type Description	<=32 chars	"Energys ()"			BT25,DES	
Battery 25 Type		"XE60"			BT25,BTY	
Battery 25 Class		"VALVE-REG"			BT25,BTC	
Battery 25 Capacity		59.3			BT25,CAP	
Batteries	Battery Model	≤ 14 Characters	"Valve-Reg"			DC1,BTY
	Number Of Battery Strings	0 to 16 Strings	0			DC1,NST
Controller	Site ID	≤ 20 characters	""			PS1,SID
	Site Description	≤ 55 characters	""			PS1,SDE
	Controller Description	≤ 32 characters	"Pulsar Edge "			PS1,DES
	DC Plant 1 Description	≤ 30 characters	""			DC1,DES
	System Description	≤ 55 characters	""			PS1,SYS
	Plant Voltage Type	24V or 48V		"24"	"48V"	DC1,TYP
	Automatic Daylight Savings Feature	1=Enabled 0=Disabled		1		PS1,DLS

Table 6: Standard Configuration Items

Category	Description	Range	Factory Default	Factory 24V Rectifier Default Factory 24V	Factory 48V Rectifier Default Factory 48V	obj,attr
			Factory			
Controller	Display Contrast	0 to 100%	55			PSI,DCT
	Temperature Display Units	C or F	"C"			PSI,TUN
	Controller Ambient TemperatureHigh	35 to 75 cC 85 to 167F	75			AMTHI,THR
	Controller Ambient TemperatureLow	-40 to 10 C -40 to 50F	-40			AMTLI,THR
	Date Format	mm/dd/yyyy,dd/mm/yyyy,yyyy/mm/dd,mm-dd-yyyy ,yyy-mm-dd, dd-mm-yyyy, mm/dd/yy, yy/mm/dd, dd/mm/yy, mm-dd-yy, yy-mm-dd, dd-mm-yy	"MM/DD/YYYY"			PSI,DTF
	Time Format	12 or 24	12			PSI,TMF
	Front Panel Configuration	1=Enabled 0=Disabled	1			PSI,FPC
	Remote rectifier Off	1=Enabled 0=Disabled	1			PSI,RRF
	Emergency Power-off Enable	1=Enabled 0=Disabled	1			PSI,POE
	User Name Login Enable	1=Enabled 0=Disabled	0			PSI,USR
	Front Panel PIN enable	1=Enabled 0=Disabled	0			PSI,FPE
	Front Panel Pin Default	Four digits 0-9	"0000"			PSI,FPP
	Front Panel PIN timeout	1 to 120 minutes	30			PSI,FPT
	Daylight Saving Start	mon:wk:dow:mi n mon:- l:dom:min	"3:2:0:120"			PSI,DSS
	Daylight Saving End	mon:wk:dow:mi n mon:- l:dom:min	"11:1:0:120"			PSI,DSE
	Time zone offset	-840 - +840 minutes (±14 hours)	0			PSI,TZO
	Uninstall Equipment Timeout	0 to 60s	15			PSI,UET
	Critical Equals Major	1=Enabled 0=Disabled	1			PSI,CEM
	User Password		"lineage"			PAS U,
	Super-user Password		"super-user"			PAS S,
Administrator Password		"administrator"			PAS A,	

Table 6: Standard Configuration Items

Category	Description	Range	Factory Default	Factory 24V Rectifier Default	Factory 48V Rectifier Default	obj,attr
			Factory	Factory 24V	Factory 48V	
Low Voltage Disconnects Battery Disconnect 1	Battery Disconnect Control Mode	0=none, 1=voltage 2=voltage/ time, 3=adaptive	1			CN1,DAM
	Battery Disconnect Time Delay	0:0:0 to 4:59:59	0:00:00			CN1,DDY
	Battery Reconnect Control Mode	0=none, 1=voltage 2=voltage/ time	1			CN1,RAM
	Battery Reconnect Time Delay	0 to 300 sec	0			CN1,RDY
	Battery Disconnect Description	<=32 Chars	"LVBD"			CN1,DES
	Battery Disconnect Open Description	<=32 Chars	"LVBD Open"			CNO1,DES
	Battery Disconnect Open Front Panel Description	<=32 Chars	"LVBD Open"			CNO1,FDS
	Battery Disconnect Failed Description	<=32 Chars	"LVBD Failed"			CNF1,DES
	Battery Disconnect Failed Front Panel Description	<=32 Chars	"LVBD Failed"			CNF1,FDS
Load Disconnect 1	Load 1 Disconnect	1=Enabled 0=Disabled	0			CN2,ENA
	Load 1 Disconnect Control Mode	0=none, 1=voltage 2=voltage/ time	1			CN2,DAM
	Load 1 Disconnect Voltage	19.5 to 25V -39.0 to -50V		21.50	43.00	CN2,DTH
	Load 1 Disconnect Time Delay	0:0:0 to 4:59:59	0:00:00			CN2,DDY
	Load 1 Reconnect Control Mode	0=none, 1=voltage 2=voltage/ time	1			CN2,RAM
	Load 1 Reconnect Voltage	19.5 to 27 -39.0 to - 55.0V		22.00	44.00	CN2,RTH
	Load 1 Reconnect Time Delay	0 to 300 sec	0			CN2,RDY
	Load 1 Disconnect Description	<=32 Chars	"LVLD1"			CN2,DES
	Load 1 Disconnect Open Description	<=32 Chars	"LVLD1 Open"			CNO2,DES

Table 6: Standard Configuration Items

Category	Description	Range	Factory Default	Factory 24V Rectifier Default	Factory 48V Rectifier Default	obj,attr
			Factory	Factory 24V	Factory 48V	
	Load 1 Disconnect Open Front Panel Description	<=32 Chars	"LVLD1 Open"			CNO2,FDS
	Load 1 Disconnect Failed Description	<=32 Chars	"LVLD1 Failed"			CNF2,DES
	Load 1 Disconnect Failed Front Panel Description	<=32 Chars	"LVLD1 Failed"			CNF2,FDS
Load Disconnect 2	LV Load 2 Disconnect	1=Enabled 0=Disabled	0			CN3,ENA
	LV Load 2 Disconnect Control Mode	0=none, 1=voltage 2=voltage/ time	1			CN3,DAM
	LV Load 2 Disconnect Voltage	19.5 to 25V		21.00	42.00	CN3,DTH
	LV Load 2 Disconnect Time Delay	0:0:0 to 4:59:59	0:00:00			CN3,DDY
	LV Load 2 Reconnect Control Mode	0=none, 1=voltage 2=voltage/ time	1			CN3,RAM
	LV Load 2 Reconnect Voltage	19.5 to 27 -39.0 to - 55.0V		22.00	44.00	CN3,RTH
	LV Load 2 Reconnect Time Delay	0 to 300 sec	0			CN3,RDY
	Load 2 Disconnect Description	<=32 Chars	"LVLD2"			CN3,DES
	Load 2 Disconnect Open Description	<=32 Chars	"LVLD2 Open"			CNO3,DES
	Load 2 Disconnect Open Front Panel Description	<=32 Chars	"LVLD2 Open"			CNO3,FDS
	Load 2 Disconnect Failed Description	<=32 Chars	"LVLD2 Failed"			CNF3,DES
	Load 2 Disconnect Failed Front Panel	<=32 Chars	"LVLD2 Failed"			CNF3,FDS
Load Disconnect	Load 3 Disconnect	1=Enabled 0=Disabled	0			CN4,ENA
	Load 3 Disconnect Control Mode	0=none, 1=voltage 2=voltage/ time	1			CN4,DAM
	Load 3 Disconnect Voltage	19.5 to 25V -39.0 to -50V		21.00	42.00	CN4,DTH
	Load 3 Disconnect Time Delay	0:0:0 to 4:59:59	0:00:00			CN4,DDY

Table 6: Standard Configuration Items

Category	Description	Range	Factory Default	Factory 24V Rectifier Default	Factory 48V Rectifier Default	obj,attr
			Factory	Factory 24V	Factory 48V	
	Load 3 Reconnect Control Mode	0=none, 1=voltage 2=voltage/time	1			CN4,RAM
	Load 3 Reconnect Voltage	19.5 to 27 -39.0 to -55.0V		22.00	44.00	CN4,RTH
	Load 3 Reconnect Time Delay	0 to 300 sec	0			CN4,RDY
	Load 3 Disconnect Description	<=32 Chars	"LVLD3"			CN4,DES
	Load 3 Disconnect Open Description	<=32 Chars	"LVLD3 Open"			CNO4,DES
	Load 3 Disconnect Open Front Panel Description	<=32 Chars	"LVLD3 Open"			CNO4,FDS
	Load 3 Disconnect Failed Description	<=32 Chars	"LVLD3 Failed"			CNF4,DES
	Load 3 Disconnect Failed Front Panel Description	<=32 Chars	"LVLD3 Failed"			CNF4,FDS
Contactors Interfaces	Built-in Type	None/CN1/ CN2/ CN3/CN4	"CN1"			DCNC1,TYP
	ID1 Type	None/CN1/ CN2/ CN3/CN4	"CN1"			DCN01,TYP
	ID2 Type	None/CN1/ CN2/ CN3/CN4	"CN2"			DCN02,TYP
	ID3 Type	None/CN1/ CN2/ CN3/CN4	"CN3"			DCN03,TYP
	ID4 Type	None/CN1/ CN2/ CN3/CN4	"CN4"			DCN04,TYP
	ID5 Type	None/CN1/ CN2/ CN3/CN4	"None"			DCN05,TYP
	ID6 Type	None/CN1/ CN2/ CN3/CN4	"None"			DCN06,TYP
	ID7 Type	None/CN1/ CN2/ CN3/CN4	"None"			DCN07,TYP
	ID8 Type	None/CN1/ CN2/ CN3/CN4	"None"			DCN08,TYP
	Imminent LVBD Shutdown	1=Enabled 0=Disabled	1			DC1,ISD
	Imminent Shutdown Delay	2 to 120 seconds	15			DC1,ISY
	Imminent LVBD Shutdown	1=Enabled 0=Disabled	1			DC1,ISD
Rectifiers	Rectifier Redundancy Loss Enable	1=Enabled 0=Disabled	0			GM1,RME
	Rectifier Loadshare Enable	1=Enabled 0=Disabled	1			GM1,LSE
	Rectifier Float Current Limit	30 to 100%	100			GM1,FCL

Table 6: Standard Configuration Items

Category	Description	Range	Factory Default	Factory 24V Rectifier Default	Factory 48V Rectifier Default	obj,attr
			Factory	Factory 24V	Factory 48V	
	Rectifier Boost Current Limit	30 to 100%	100			GM1,BCL
	Group Standby/ Sequencing Enable	1=Enabled 0=Disabled	0			DC1,RSQ
	Remote rectifier Off Enable	1=Enabled 0=Disabled	1			PS1,RRF
	Rectifier Redundancy Threshold	1 to 80	1			RLS1,THR
	Multiple Rectifier Fail	2 to 88	2			MFA1,THR
	Oring FET test enable	1=Enabled 0=Disabled	1			GM1,OFT
	Efficiency Enable	1=Enabled 0=Disabled	0			DC1,EME
	Efficiency Target	20% to 95%	70			DC1,EMT
	Efficiency Rectifier Turn OnThreshold	25% to 100%	76			DC1,EMO
	Efficiency initial delay	1 to 30 minutes	10			DC1,EMI
	Efficiency Inter-Rectifier delay	1 to 30 minutes	10			DC1,EMW
	Walk-In Enable	1=Enabled 0=Disabled	1			GM1,WIE
Converters	Converter Current Limit	30 to 100%	100			CP1,CLM
	Converter Redundancy LossEnable	1=Enabled 0=Disabled	1			CP1,RME
	Remote converter Off Enable	1=Enabled 0=Disabled	0			CP1,ROF
	Low Voltage Disconnect InputThreshold	20.0 to 25.0V 40.0 to 50.0V			23.0 46.0	CP1,DTH
	Low Voltage Reconnect InputThreshold	22.0 to 27.0V 44.0 to 54.0V			25.0 50.0	CP1,RTH
	Low Voltage Disconnect Enable	1=Enabled 0=Disabled	0			CP1,LVD
	Converter Redundancy Threshold	1 to 32	1			CRL1,THR
	Multiple Converter Fail	2 to 8	2			CMFA1,THR
Battery Discharge Test	Timed Test Duration	0:0:0 to 23:59:59	2:00:00			BR1,TMD
	Automatic Battery Test Feature	disabled, 20%, timed, Ah Out	"disabled"			BR1,BTE
	Automatic Test (AT) Interval	1 to 18 Months	12			BR1,TIN
	Date For Next Automatic Test	yyyy-mm-dd	1/1/2099			BR1,ATD
	Start Time For Automatic Test	0 to 23	0			BR1,ATH
	Hours To Wait From Last BD BeforeAT	0 to 240 hours	72			BR1,ATW
	Manual Test Type	disabled, 20%, timed, Ah Out	"20%"			BR1,MTT

Table 6: Standard Configuration Items

Category	Description	Range	Factory Default	Factory 24V Rectifier Default	Factory 48V Rectifier Default	obj,attr
			Factory	Factory 24V	Factory 48V	
	Battery test Ah to be removed	10-1000Ah	10			BRI,AHO
	Reserve Time Low (Full Capacity)	00:00 to 99:59	00:00			RTL1,THR
	Real-time Reserve Low (During BD)	00:00 to 99:59	00:00			RRTL1,THR
Battery Boost	Boost Maximum Duration	1 to 80 Hours	1			BSI,TMD
	Automatic Boost Feature	disabled, timed, or current	"disabled"			BSI,ATM
	Auto Boost BD Multiplication Factor	0.1 to 9.0	0.5			BSI,AMF
	Auto Boost Termination Current Threshold	1 to 999A	5			BSI,CTA
Shunt Monitors	Plant Shunt Type	Battery/None /Load	"BATTERY"			DCMC1,TYP
	Plant Shunt Current Rating	0 to 9999 Amps	100			DCMC1,SHA
	ID1 Type	Battery/None /Load	"BATTERY"			DCM01,TYP
	ID1 Shunt Current Rating	0 to 9999 Amps	100			DCM01,SHA
	ID2 Type	Battery/None /Load	"NONE"			DCM02,TYP
	ID2 Shunt Current Rating	0 to 9999 Amps	100			DCM02,SHA
	ID3 Type	Battery/None /Load	"NONE"			DCM03,TYP
	ID3 Shunt Current Rating	0 to 9999 Amps	100			DCM03,SHA
	ID4 Type	Battery/None /Load	"NONE"			DCM04,TYP
	ID4 Shunt Current Rating	0 to 9999 Amps	100			DCM04,SHA
	ID5 Type	Battery/None /Load	"NONE"			DCM05,TYP
	ID5 Shunt Current Rating	0 to 9999 Amps	100			DCM05,SHA
	ID6 Type	Battery/None /Load	"NONE"			DCM06,TYP
ID6 Shunt Current Rating	0 to 9999 Amps	100			DCM06,SHA	

Table 6: Standard Configuration Items

Category	Description	Range	Factory Default	Factory 24V Rectifier Default	Factory 48V Rectifier Default	obj,attr
			Factory	Factory 24V	Factory 48V	
Built-in Inputs	Input 1 Description	<=32 chars	"Fuse Alarm Major"			IN001,DES
	Input 1 Type		"FAJ1"			IN001,TYP
	Input 1 Active State	CLOSED=Battery OPEN=No BAT	"CLOSED"			IN001,POL
	Input 2 Description	<=32 chars	"Open String"			IN002,DES
	Input 2 Type		"OSA"			IN002,TYP
	Input 2 Active State	CLOSED=Battery OPEN=No BAT	"CLOSED"			IN002,POL
	Input 3 Description	<=32 chars	"Auxiliary Major Alarm"			IN003,DES
	Input 3 Type		"AMJ"			IN003,TYP
	Input 3 Active State	CLOSED=Battery OPEN=No BAT	"CLOSED"			IN003,POL
	Input 4 Description	<=32 chars	"Air Conditioner Fail"			IN004,DES
	Input 4 Type		"AUX1"			IN004,TYP
	Input 4 Active State	CLOSED=Battery OPEN=No BAT	"CLOSED"			IN004,POL
	Input 5 Description	<=32 chars	"Door Open"			IN005,DES
	Input 5 Type		"AUX2"			IN005,TYP
	Input 5 Active State	CLOSED=Battery OPEN=No BAT	"CLOSED"			IN005,POL
	Input 6 Description	<=32 chars	"SPD Fail"			IN006,DES
	Input 6 Type		"AUX3"			IN006,TYP
	Input 6 Active State	CLOSED=Battery OPEN=No BAT	"CLOSED"			IN006,POL
	Input 7 Description	<=32 chars	"PBT/TR"			IN007,DES
	Input 7 Type		"			IN007,TYP
	Input 7 Active State	CLOSED=Closed to RTN, OPEN=Open to RTN	"CLOSED"			IN007,POL
Input 8 Description	<=32 chars	"High External Ambient"			IN008,DES	
Input 8 Type		"AUX4"			IN008,TYP	
Input 8 Active State	CLOSED=Closed to RTN, OPEN=Open to RTN	"CLOSED"			IN008,POL	
Input 9 Description	<=32 chars	"Low External Ambient"			IN009,DES	
Input 9 Type		"AUX5"			IN009,TYP	

Table 6: Standard Configuration Items

Category	Description	Range	Factory Default	Factory 24V Rectifier Default	Factory 48V Rectifier Default	obj,attr
			Factory	Factory 24V	Factory 48V	
Built-in Inputs	Input 9 Active State	CLOSED=Closed to RTN, OPEN=Open to RTN	"CLOSED"			IN009,POL
	Input 10 Description	<=32 chars	"Fan Fail"			IN010,DES
	Input 10 Type		"AUX6"			IN010,TYP
	Input 10 Active State	CLOSED=Closed to RTN, OPEN=Open to RTN	"CLOSED"			IN010,POL
	Input 11 Description	<=32 chars	"Hydrogen Present"			IN011,DES
	Input 11 Type		"AUX7"			IN011,TYP
	Input 11 Active State	CLOSED=Closed to RTN, OPEN=Open to RTN	"CLOSED"			IN011,POL
	Input 12 Description	<=32 chars	"Customer Alarm 1"			IN012,DES
	Input 12 Type		"AUX8"			IN012,TYP
	Input 12 Active State	CLOSED=Closed to RTN, OPEN=Open to RTN	"CLOSED"			IN012,POL
	Input 13 Description	<=32 chars	"Customer Alarm 2"			IN013,DES
	Input 13 Type		"AUX9"			IN013,TYP
	Input 13 Active State	CLOSED=Closed to RTN, OPEN=Open to RTN	"CLOSED"			IN013,POL
	Input 14 Description	<=32 chars	"Customer Alarm 3"			IN014,DES
	Input 14 Type		"AUX10"			IN014,TYP
	Input 14 Active State	CLOSED=Closed to RTN, OPEN=Open to RTN	"CLOSED"			IN014,POL
	Input 15 Description	<=32 chars	"Customer Alarm 4"			IN015,DES
	Input 15 Type		"AUX11"			IN015,TYP
	Input 15 Active State	CLOSED=Closed to RTN, OPEN=Open to RTN	"CLOSED"			IN015,POL
	Auxiliary Alarm 1 Description	<=32 chars	"Air Conditioner Fail"			AUX1,DES
	Auxiliary Alarm 1 Front Panel Desc	<=24 chars	"Air Cond Fail"			AUX1,FDS
	Auxiliary Alarm 2 Description	<=32 chars	"Door Open"			AUX2,DES
	Auxiliary Alarm 2 Front Panel Desc	<=24 chars	"Door Open"			AUX2,FDS
	Auxiliary Alarm 3 Description	<=32 chars	"SPD Fail"			AUX3,DES

Table 6: Standard Configuration Items

Category	Description	Range	Factory Default	Factory 24V Rectifier Default	Factory 48V Rectifier Default	obj,attr
			Factory	Factory 24V	Factory 48V	
Built-in Inputs	Auxiliary Alarm 3 Front Panel Desc	<=24 chars	"SPD Fail"			AUX3,FDS
	Auxiliary Alarm 4 Description	<=32 chars	"High External Ambient"			AUX4,DES
	Auxiliary Alarm 4 Front Panel Desc	<=24 chars	"High Ext Ambient"			AUX4,FDS
	Auxiliary Alarm 5 Description	<=32 chars	"Low External Ambient"			AUX5,DES
	Auxiliary Alarm 5 Front Panel Desc	<=24 chars	"Low Ext Ambient"			AUX5,FDS
	Auxiliary Alarm 6 Description	<=32 chars	"Fan Fail"			AUX6,DES
	Auxiliary Alarm 6 Front Panel Desc	<=24 chars	"Fan Fail"			AUX6,FDS
	Auxiliary Alarm 7 Description	<=32 chars	"Hydrogen Present"			AUX7,DES
	Auxiliary Alarm 7 Front Panel Desc	<=24 chars	"Hydrogen Present"			AUX7,FDS
	Auxiliary Alarm 8 Description	<=32 chars	"Customer Alarm 1"			AUX8,DES
	Auxiliary Alarm 8 Front Panel Desc	<=24 chars	"Customer Alarm 1"			AUX8,FDS
	Auxiliary Alarm 9 Description	<=32 chars	"Customer Alarm 2"			AUX9,DES
	Auxiliary Alarm 9 Front Panel Desc	<=24 chars	"Customer Alarm 2"			AUX9,FDS
	Auxiliary Alarm 10 Description	<=32 chars	"Customer Alarm 3"			AUX10,DES
	Auxiliary Alarm 10 Front Panel Desc	<=24 chars	"Customer Alarm 3"			AUX10,FDS
	Auxiliary Alarm 11 Description	<=32 chars	"Customer Alarm 4"			AUX11,DES
	Auxiliary Alarm 11 Front Panel Desc	<=24 chars	"Customer Alarm 4"			AUX11,FDS
	Auxiliary Alarm 12 Description	<=32 chars	"Customer Alarm 5"			AUX12,DES
Auxiliary Alarm 12 Front Panel Desc	<=24 chars	"Customer Alarm 5"			AUX12,FDS	
Alarm Test	Alarm Test Enable	1=Enabled 0=Disabled	1			AT1,LTE
	Duration of Each Relay Closure	5 to 300 sec	30			AT1,DUR
	PMJ Relay Test Enable	1=Enabled 0=Disabled	1			AT1,PMJ
	PMN Relay Test Enable	1=Enabled 0=Disabled	1			AT1,PMN
	R1 Relay Test Enable	1=Enabled 0=Disabled	1			AT1,R1
	R2 Relay Test Enable	1=Enabled 0=Disabled	1			AT1,R2
	R3 Relay Test Enable	1=Enabled 0=Disabled	1			AT1,R3

Table 6: Standard Configuration Items

Category	Description	Range	Factory Default	Factory 24V Rectifier Default	Factory 48V Rectifier Default	obj,attr
			Factory	Factory 24V	Factory 48V	
Serial Communication Ports	Communication Port Type	LOCAL or MODEM	"LOCAL"			PS1,PTT
	Local Port Write Access	1=Enabled 0=Disabled	1			LP1,WRE
	Local RS-232 baud rate	2400/4800/ 9600/ Auto	"AUTO"			LP1,BDR
	Local RS-232 handshaking (Flow Control)	No/SW/HW	"NO"			LP1,HSH
	Number of Local RS-232 data bits	7,8	8			LP1,DBT
	Local RS-232 parity	n,e,o	N			LP1,PRY
	Number of Local RS-232 stop bits	1,2	1			LP1,SBT
	Local RS-232 Time-out	0-45 minutes	5			LP1,TMO
	Local RS-232 Application	TERMINAL, EVENT LOG	"TERMINAL"			LP1,APP
	Modem Port Write Access	1=Enabled 0=Disabled	1			MP1,WRE
	Modem baud rate	2400/4800/ 9600	"2400"			MP1,BDR
	Number Of Modem data bits	7,8	8			MP1,DBT
	Modem parity	n,e,o	N			MP1,PRY
	Number Of Modem stop bits	1,2	1			MP1,SBT
	Modem Time-out	0-45 minutes	5			MP1,TMO
	Modem initialization string	≤ 20 Characters	"AT&FEV&C1S0=0 H"			MP1,INS
	Modem number of rings before answering	1 to 9	1			MP1,NRG
Modem handshaking (Flow Control)	No/SW/HW	"NO"			MP1,HSH	
Network Port	DHCP	0=static1=client 2=server	1			NET1,DHCP
	Static IP Address	xxx.xxx.xxx.xxx	"0.0.0.0"			NET1,IP
	Static Subnet Mask	xxx.xxx.xxx.xxx	"0.0.0.0"			NET1,SUB
	Static Gateway (Router) IP	xxx.xxx.xxx.xxx	"0.0.0.0"			NET1,GTWY
	Static Domain Name	text				NET1,DOM
	Static DNS IP	xxx.xxx.xxx.xxx	"0.0.0.0"			NET1,DNS
	Hostname	text				NET1,HOST
	Mailhost IP	xxx.xxx.xxx.xxx	"0.0.0.0"			NET1,MSRV
	Timeout	0 to 45 minutes	10			NET1,TMO
	Time Server IP address	xxx.xxx.xxx.xxx	"0.0.0.0"			NET1,NTP
	Network Port Write Access	1=Enabled 0=Disabled	1			NET1,WRE

Table 6: Standard Configuration Items

Category	Description	Range	Factory Default	Factory 24V Rectifier Default	Factory 48V Rectifier Default	obj,attr
			Factory	Factory 24V	Factory 48V	
Standard Alarms	Alarm Delay	0 to 9 minutes	0			SDA,DLY
	Notify On Occur	1=Enabled 0=Disabled	0			SDA,NOO
	Notify On Retire	1=Enabled 0=Disabled	0			SDA,NOR
	Nag On Occur	1=Enabled 0=Disabled	0			SDA,NAG
	Notify Destination		""			SDA,DST
Single Threshold Alarms	Alarm Delay	0 to 9 minutes	0			THA,DLY
	Notify On Occur	1=Enabled 0=Disabled	0			THA,NOO
	Notify On Retire	1=Enabled 0=Disabled	0			THA,NOR
	Nag On Occur	1=Enabled 0=Disabled	0			THA,NAG
	Notify Destination		""			THA,DST
Alarm Call-Out	Nag Interval	15 to 60 minutes	15			CM1,NGI
	Call-Out Destination Type	data or pager	"DATA"			COP,TYP
	Call-Out Phone Number	up to 25 Characters	""			COP,PHN
	Call-Out Baudrate	300, 1200, 2400, 4800, 9600, 19200	2400			COP,BDR
	Call-out Data Bits	7 or 8	8			COP,DBT
	Call-Out Parity	n,e,o	N			COP,PRY
	Call-Out Stop Bits	1 or 2	1			COP,SBT
	Pager ID Delay	0 to 9 seconds	0			COP,DLY
	Pager ID	up to 25 Characters	""			COP,PGR
	Pager Message	up to 25 Characters	""			COP,MSG
Periodic Dial-Out	Phone Number	up to 25 Characters	""			PSO,PHN
	Baudrate	300, 1200, 2400, 4800, 9600, 19200	2400			PSO,BDR
	Data Bits	7 or 8	8			PSO,DBT
	Parity	n,e,o	N			PSO,PRY
	Stop Bits	1 or 2	1			PSO,SBT

Table 6: Standard Configuration Items

Category	Description	Range	Factory Default	Factory 24V Rectifier Default	Factory 48V Rectifier Default	obj,attr
			Factory	Factory 24V	Factory 48V	
Periodic Dial-Out	Interval	Sunday-Saturday, Daily, Monthly, Quarterly, Never	"Never"			POI,INT
	Time	hh:mm	6:00			PSO,TIM
	Command Line 1	<=40 characters	""			PSO,CL01
	Command Line 2	<=40 characters	""			PSO,CL02
	Command Line 3	<=40 characters	""			PSO,CL03
	Command Line 4	<=40 characters	""			PSO,CL04
	Command Line 5	<=40 characters	""			PSO,CL05
	Command Line 6	<=40 characters	""			PSO,CL06
	Command Line 7	<=40 characters	""			PSO,CL07
	Command Line 8	<=40 characters	""			PSO,CL08
	Command Line 9	<=40 characters	""			PSO,CL09
Command Line 10	<=40 characters	""			PSO,CL10	
Alarm Email Notification	IP Address		""			COE,ADR
	Email Type	normal or pager	"NORMAL"			COE,TYP
Call-Back Security	Call-Back Security Enable	1=Enabled 0=Disabled	0			CBS,STT
	Phone Number 1	up to 25 Characters	""			CBS,PH1
	Baudrate 1	300, 1200, 2400, 4800, 9600, 19200	2400			CBS,BR1
	Phone Number 2	up to 25 Characters	""			CBS,PH2
	Baudrate 2	300, 1200, 2400, 4800, 9600, 19200	2400			CBS,BR2
	Phone Number 3	up to 25 Characters	""			CBS,PH3

Table 6: Standard Configuration Items

Category	Description	Range	Factory Default	Factory 24V Rectifier Default	Factory 48V Rectifier Default	obj,attr
			Factory	Factory 24V	Factory 48V	
Call-Back Security	Baudrate 3	300, 1200, 2400, 4800, 9600, 19200	2400			CBS,BR3
	Phone Number 4	up to 25 Characters	""			CBS,PH4
	Baudrate 4	300, 1200, 2400, 4800, 9600, 19200	2400			CBS,BR4
	Phone Number 5	up to 25 Characters	""			CBS,PH5
	Baudrate 5	300, 1200, 2400, 4800, 9600, 19200	2400			CBS,BR5
SNMP Destination	IP Address		"0.0.0.0"			SND,IP
	Community String 1 Write Enable	0=disable 1=enable SETs	0			CS1,WRE
	Community 1 String	up to 20 Characters	"public"			CS1,STR
	Community String 1 IP Address	xxx.xxx.xxx.xxx	"0.0.0.0"			CS1,IP
	Community String 1 IP AddressMask	xxx.xxx.xxx.xxx	"255.255.255.255"			CS1,IPM
	Community String 2 Write Enable	0=disable 1=enable SETs	1			CS2,WRE
	Community 2 String	up to 20 Characters	"public-write"			CS2,STR
	Community String 2 IP Address	xxx.xxx.xxx.xxx	"0.0.0.0"			CS2,IP
	Community String 2 IP AddressMask	xxx.xxx.xxx.xxx	"255.255.255.255"			CS2,IPM
	Community String 3 Write Enable	0=disable 1=enable SETs	1			CS3,WRE
	Community 3 String	up to 20 Characters	"private"			CS3,STR
	Community String 3 IP Address	xxx.xxx.xxx.xxx	"0.0.0.0"			CS3,IP
	Community String 3 IP AddressMask	xxx.xxx.xxx.xxx	"255.255.255.255"			CS3,IPM

Table 6: Standard Configuration Items

Category	Description	Range	Factory Default		Factory 24V Rectifier Default	Factory 48V Rectifier Default	obj,attr
			Factory	Factory 24V	Factory 24V	Factory 48V	
TL1 Manager	Activate User Enable	1=Enabled 0=Disabled	0				TLM,AUE
	CTS Detection Enable	1=Enabled 0=Disabled	0				TLM,CTS
	DSR Detection Enable	1=Enabled 0=Disabled	0				TLM,DSR
	Timeout	0 to 60 minutes	0				TLM,TMO
	Port	0 to 65535	2020				TLM,PRT

Table 6: Standard Configuration Items

Category	Description	Range	Valve-Reg	Flooded	Li_ELITE	NiCd	Li-LMP	obj,attr
Voltage Settings	Rectifier Float Selective High Voltage Shutdown	-50 to -60V	58.50	58.50	58.50	58.50	58.50	GM1,FSD
	High Float Voltage Major Alarm	-50 to -60V	57.00	57.00	57.00	57.00	57.00	HVA1,FT H
	High Float Voltage Minor Alarm	-50 to -60V	56.00	56.00	56.00	56.00	56.00	HFV1,FT H
	Rectifier/System Float Voltage	-42 to -56.5V	54.48	52.08	54.48	54.40	54.48	GM1,FSP
	Battery on Discharge Float Alarm	-46 to -55V	51.00	50.00	53.00	51.00	51.00	BDA1,FT H
	Very Low Float Voltage Alarm	-40 to -51V	46.00	46.00	46.00	46.00	46.00	VLA1,TH R
	Rectifier On Threshold	-40 to -51V	44.00	44.00	44.00	44.00	44.00	DC1,ROT
Battery Disconnect	LV Battery Disconnect	1=Enabled 0=Disabled	1	1	0	1	0	CN1,ENA
	LV Battery Disconnect Voltage	-39.0 to -50V	42.00	42.00	42.00	42.00	42.00	CN1,DTH
	LV Battery Reconnect Voltage	-39.0 to -55V	48.00	48.00	48.00	48.00	48.00	CN1,RTH
	Battery Disconnect Voltage or Disconnect Threshold V min in adaptive mode	39V to 50V	42.00	42.00	42.00	42.00	42.00	CN1,DTH
	Disconnect threshold Vmax in adaptive mode	39V to 50V	46.00	46.00	46.00	46.00	46.00	CN1,DVX
	Imin in adaptive mode	0A to 9999A	3	3	3	3	3	CN1,DIN
	Imax in adaptive mode	0A to 9999A	300	300	300	300	300	CN1,DIX
Batteries	Cells Per String	0 to 75	24	24	24	24	24	DC1,CPS
	String End Of Discharge Voltage	-40.25 to -48.75V	42.00	42.00	42.00	42.00	42.00	BRI,CEV
	Recharge Current Limit Feature	1=Enabled 0=Disabled	1	0	0	0	1	BRI,CLE
	Recharge Current Limit Value	5 to 1000A	50	50	25	25	25	BRI,CLT
	Boost Maximum Duration	1 to 80 Hours	1	1	1	1	1	BS1,TMD
	Voltage Imbalance Detect	1.5V to 3.0V	1.7	1.7	1.7	2.0	1.7	BRI,SCV
	High Temperature Battery Disconnect	30 to 90°C	75	75	75	75	75	BRI,TTH
	High Battery Temperature	30 to 85°C	55	55	55	55	85	BTHA1,TH R
	Very High Battery Temperature	30 to 85°C	65	65	65	65	85	BTVH1,TH R
	Low Battery Temperature	-40 to 10°C	-10	-10	-10	-10	-10	BTLA1,TH R
	Very Low Battery Temperature	-40 to 10°C	-20	-20	-20	-20	-20	BTVL1,TH R

Table 7 48V Battery Related Items

Category	Description	Range	Valve-Reg	Flooded	Li_ELITE	NiCd	Li-LMP	obj,attr
Battery Slope Compensation	Slope Thermal Compensation (STC)	1=Enabled 0=Disabled	0	0	0	0	0	SC1,STT
	High Temperature Voltage Step Down	45 to 85°C	75	75	75	75	75	SC1,SPT
	High Temperature Compensation Stop	30 to 55°C	55	55	55	55	55	SC1,UTT
	High Temperature Decrease Rate	1-10mV/°C per cell	3	3	3	3	3	SC1,USP
	Nominal Temperature (No Temp Comp)	15 to 30 °C	25	25	25	25	25	SC1,NTT
	Low Temperature Compensation Feature	1=Enabled 0=Disabled	0	0	0	0	0	SC1,RVE
	Low Temperature Compensation Stop	-5 to 20°C	0	0	0	0	0	SC1,LTT
	Low Temperature Decrease Rate	1-10mV/°C per cell	3	3	3	3	3	SC1,LSP
	Probe Fail-Safe Enable	1=Enabled 0=Disabled	0	0	0	0	0	SC1,FSE
Battery Discharge Test	Timed Test Alarm Voltage Threshold	-36 to -48V	44.00	44.00	46.00	44.0 0	44.00	BR1,TEV
	Rectifier Voltage During Battery Test	-42.00 to -52V	42.00	42.00	42.00	42.00	42.00	BR1,BTV
Battery Boost	Boost Rectifier High Voltage Shutdown	-52 to -60V	58.50	58.50	58.50	58.50	58.50	GM1,BS D
	Boost High Voltage Major Alarm	-50 to -60V	57.0	58.5	57.0	57.0	57.0	HVA1,BT H
	Boost High Voltage Minor Alarm	-50 to -60V	56.0	58.0	56.0	56.0	56.0	HFV1,BT H
	Boost Voltage	-48 to -58V	55.2	57.0	54.5	54.4	54.5	GM1,BS P
	Boost Battery on Discharge Alarm	-46 to -55V	51.0	50.0	53.0	51.0	51.0	BDA1,BT H

Table 7 48V Battery Related Items

Category	Description	Range	Valve-Reg	Flooded	Li_ELiTE	NiCd	Li-LMP	obj,attr
Voltage Settings	Float Rectifier High Voltage Shutdown	25 to 30V	29.25	29.25	29.25	29.25	29.25	GM1,FS D
	Float High Voltage Major Alarm	25.74 to 31.75V	28.24	28.24	28.24	28.24	28.24	HVA1,FT H
	Float High Voltage Minor Alarm	24.75 to 29.75V	27.74	27.74	27.74	27.74	27.74	HFV1,FT H
	Float Voltage	21 to 28V	27.24	26.04	27.24	27.20	27.24	GM1,FS P
	Float Battery on Discharge Alarm	23 to 28V	25.54	25.00	26.50	25.54	25.54	BDA1,FT H
	Very Low Voltage Alarm	20 to 25.5V	23.00	23.00	23.00	23.00	23.00	VLA1,TH R
	Rectifier On Threshold	20 to 25V	22.00	22.00	22.00	22.00	22.00	DC1,RO T
Battery Disconnect	LV Battery Disconnect	1=Enabled 0=Disabled	1	1	0	1	0	CN1,EN A
	LV Battery Disconnect Voltage	19.5 to 25V	21.00	21.00	21.00	21.00	21.00	CN1,DT H
	LV Battery Reconnect Voltage	19.5 to 25V	22.20	22.20	22.20	22.20	22.20	CN1,RT H
	Battery Disconnect Voltage or Disconnect threshold Vmin in adaptive mode	39V to 50V	21.00	21.00	21.00	21.00	21.00	CN1,DT H
	Disconnect threshold Vmax in adaptive mode	39V to 50V	23.00	23.00	23.00	23.00	23.00	CN1,DV X
	Imin in adaptive mode	0A to 9999A	3	3	3	3	3	CN1,DIN
	Imax in adaptive mode	0A to 9999A	300	300	300	300	300	CN1,DIX
Batteries	Cells Per String	0-75	12	12	12	12	12	DC1,CP S
	Fail Safe Enable	1=Enabled 0=Disabled	0	0	0	0	0	SC1,FSE
	String End Of Discharge Voltage	19.25 to 25.35	21.00	21.00	21.00	21.00	21.00	BR1,CE V
	Recharge Current Limit Feature	1=Enabled 0=Disabled	0	0	0	0	0	BR1,CLE
	Recharge Current Limit Value	5 to 1000A	25	25	25	25	25	BR1,CLT
	Boost Maximum Duration	1 to 80 Hours	1	1	1	1	1	BS1,TM D
	Voltage Imbalance Detect	1.5V to 3.0V	1.7	1.7	1.7	2.0	1.7	BR1,SC V
	High Temperature Battery Disconnect	30 to 90°C	75	75	75	75	75	BR1,TTH
	High Battery Temperature	30 to 85°C	55	55	55	55	85	BTHA1,T HR
	Very High Battery Temperature	30 to 85°C	65	65	65	65	85	BTVH1,T HR
	Low Battery Temperature	-40 to 10°C	-10	-10	-10	-10	-10	BTLA1,T HR
	Very Low Battery Temperature	-40 to 10°C	-20	-20	-20	-20	-20	BTVL1,T HR

Table 8 24V Battery Related Items

Category	Description	Range	Valve-Reg	Flooded	Li_ELITE	NiCd	Li-LMP	obj,attr
Battery Slope Compensation	Slope Thermal Compensation (STC)	1=Enabled 0=Disabled	0	0	0	0	0	SC1,STT
	High Temperature Voltage Step Down	45 to 85°C 113 to 185F	75	75	75	75	75	SC1,SPT
	High Temperature Compensation Stop	30 to 55°C 86 to 131F	55	55	55	55	55	SC1,UTT
	High Temperature Decrease Rate	1-10mV/°C percell	3	3	3	3	3	SC1,USP
	Nominal Temperature (No Temp Comp)	15 to 30°C 59 to 86F	25	25	25	25	25	SC1,NTT
	Low Temperature Compensation Feature	1=Enabled 0=Disabled	0	0	0	0	0	SC1,RVE
	Low Temperature Compensation Stop	-5 to 20°C 23 to 68F	0	0	0	0	0	SC1,LTT
	Low Temperature Decrease Rate	1-10mV/°C percell	3	3	3	3	3	SC1,LSP
	Rectifier Voltage During Battery Test	21 to 26V	21.00	21.00	21.00	21.00	21.00	BR1,BTV
Battery Boost	Boost Rectifier High Voltage Shutdown	26 to 30V	29.25	29.25	29.25	29.25	29.25	GM1,BS D
	Boost High Voltage Major Alarm	25.75 to 31.75V	28.24	29.00	28.24	28.24	28.24	HVA1,BT H
	Boost High Voltage Minor Alarm	25.75 to 31.75V	27.74	28.00	27.74	27.74	27.74	HFV1,BT H
	Boost Voltage	22 to 30V	27.24	26.04	27.24	27.20	27.24	GM1,BS P
	Boost Battery on Discharge Alarm	23 to 28V	25.54	25.00	26.50	25.54	25.54	BDA1,BT H

Table 8 24V Battery Related Items

Category	Description	Range	Output Converter Voltage		obj,attr
			48V Defaults	24V Defaults	
Converters	Converter Internal Selective High Output Voltage Shutdown	25.0 to 30.0V 50.0 to 60.0V	58.0	29.0	CP1,VSD
	High Output Voltage Major Alarm	25.0 to 30.0V 50.0 to 60.0V	56.0	28.5	CHVA1,THR
	High Output Voltage Minor Alarm	24.0 to 30.0V 48.0 to 60.0V	54.0	27.0	CHFV1,THR
	Output Voltage Set-Point	23.0 to 27.2V 46.0 to 54.5V	52.0	26.0	CP1,VSP
	Low Voltage Alarm	20.0 to 27.0V 40.0 to 54.0V	46.0	23.0	CVLA1,THR

Table 9 Converter Related Items

Appendix E: Alarms and Relays

Alarm Relays

The Pulsar Edge can be configured to provide up to six alarm relays depending on the controller configuration. Four alarm relays provide the alarm condition and two provide the overall system severity associated with the alarm.

Presently, the maximum number of relays available in the Infinity NE841A and QS841E is six. The maximum number of relays in the CP841A and SPS841A controllers is five. The severity relays transmit Power Major (PMJ) or Power Minor (PMN). Each alarm is factory assigned a severity based on industry practices, however, they may be reassigned to MAJ, MIN, Warning, or RO (Record Only). An alarm condition with the RO severity results in the system controller not transmitting the alarm but is stored in the history log. PCR, PMJ nor PMN severities are transmitted along with the alarm.

The four selectable alarm relays are called User Alarm Relay 1 (R1) through User Alarm Relay 4 (R4). Relays are user definable in that the user may assign any combination of alarms from a given set of alarms. The following table shows which alarms may be assigned along with their factory default settings.

Alarms

Table 10 shows a list of all alarms along with their descriptions, default settings, ranges and/or severity, and affected alarm relays and LEDs. Controllers with less relays than six will lose user relays starting with R4, then R3, etc.

Description	SEVERITY RELAY					USER RELAYS		LED	SNMP		Object ID	
	CRIT	PMJ	PMN	WRN	RO	R1	R2	R3	R4	ALM		DST
AC Fail			MIN					R3				ACF1
ACO Active					RO							AAC1
Alarm Test Aborted					RO							ATB1
Alarm Test Active					RO							ATA1
Auxiliary 1		MAJ										AUX1
Auxiliary 2		MAJ										AUX2
Auxiliary 3		MAJ										AUX3
Auxiliary 4		MAJ										AUX4
Auxiliary 5		MAJ										AUX5
Auxiliary 6		MAJ										AUX6
Auxiliary 7		MAJ										AUX7
Auxiliary 8		MAJ										AUX8
Auxiliary 9		MAJ										AUX9
Auxiliary 10		MAJ										AUX10
Auxiliary 11		MAJ										AUX11

Table 10 Alarms, Alarm Relays and LEDs Assignments

Description	SEVERITY RELAY					USER RELAYS		LED	SNMP		Object ID	
	CRIT	PMJ	PMN	WRN	RO	R1	R2	R3	R4	ALM		DST
Auxiliary Major		MAJ										AMJ1
Battery Test Active					RO							BTA1
Battery on Discharge (Float)		MAJ				R1				ALM		BDA1
Battery Voltage (Cell) Imbalance Detect			MIN									SCD1
Check Battery/Battery Test Failed			MIN									BFA1
Clock Changed					RO							CLC1
Configuration Changed					RO							CCH1
Controller Fail (Not user mappable)		x	x		x							
Converter Distribution Fuse		MAJ							R4			CDDA1
Converter Fail		MAJ					R2					CFA1
Converter Fan Fail			MIN				R2					CFN1
Converter Input Fail			MIN									CIN1
Converter Low Voltage	CRIT											CVLA1
Converter High Voltage Major		MAJ										CHVA1
Converter High Voltage Minor			MIN									CHFV1
Converter ID Conflict		MAJ										CDID1
Converter Redundancy Loss		MAJ					R2					CRL1
Emergency Power Off		MAJ										EPO1
Energy Management Disabled				WRN								EMD1
Excessive Login Attempts				WRN								EXL1
External Password Reset				WRN								EPR1
Fuse Major		MAJ							R4			FAJ1
Fuse Minor			MIN									FAN1
High Ambient Temperature			MIN									AMTH1
High Battery Temperature			MIN									BTHA1
High Voltage			MIN									HFV1
History Cleared					RO							HCL1
ID Conflict		MAJ										DID1
ID Not Configured		MAJ										ZID1
Imminent Low V Shutdown		MAJ										ISD1
Incompatible Converter			MIN									ICCT1

Table 10 Alarms, Alarm Relays and LEDs Assignments

Description	SEVERITY RELAY					USER RELAYS		LED	SNMP		Object ID	
	CRIT	PMJ	PMN	WRN	RO	R1	R2	R3	R4	ALM		DST
Incompatible Converter			MIN									ICC1
Incompatible Rectifier			MIN				R2					ICR1
Load Share Fail			MIN									LSF1
Low Ambient Temperature			MIN									AMTL1
Low Battery Temperature			MIN									BTLA1
LVBD Failed		MAJ										CNF1
LVBD Open		MAJ										CNO1
LVLD 1 Failed		MAJ										CNF2
LVLD 1 Open		MAJ										CNO2
LVLD 2 Failed		MAJ										CNF3
LVLD 2 Open		MAJ										CNO3
LVLD 3 Failed		MAJ										CNF4
LVLD 3 Open		MAJ										CNO4
Major Communication Fail Alarm		MAJ										MCM1
Manual Off			MIN									MAN1
Minor Communication Fail Alarm			MIN									CMA1
Multiple AC Fail		MAJ						R3				MACF1
Multiple Converter Fail		MAJ					R2					CMFA1
Multiple Manual Off		MAJ										MMA N1
Multiple Rectifier Fail		MAJ					R2					MFA1
No Call-Out Response				WRN								COR1
No Dial-Out Response				WRN								POR1
Open String		MAJ										OSA1
Password At Default					RO							PFD1
Processor Halt					RO							PHT1
Program Line Invalid		MAJ										PGI1
Queue Overflow				WRN								COF1
Real Time Clock Battery			MIN									BBL1
Real-Time Reserve Time					RO							RRTL1
Rectifier Current Limit					RO							CLM1
Rectifier Fail			MIN				R2					RFA1
Rectifier Fan Fail			MIN				R2					RFN1
Rectifier Internal Fault			MIN				R2					RIF1
Redundancy Loss			MIN				R2					RLS1
Reserve Time Low					RO							RTL1
Self Test Failed			MIN									STF1
Sense Fuse			MIN									VSF1

Table 10 Alarms, Alarm Relays and LEDs Assignments

Description	SEVERITY RELAY					USER RELAYS		LED	SNMP		Object ID	
	CRIT	PMJ	PMN	WRN	RO	R1	R2	R3	R4	ALM		DST
Thermal Probe Fail Safe		MAJ										PFS1
Thermal Probe Failure			MIN									TPA1
Unconfigured Alarm Destination				WRN								NNC1
Un-powered Controller (Not configurable)		x	x		x							
Very High Battery Temperature		MAJ										BTVH1
Very High Voltage		MAJ										HVA1
Very Low Battery Temperature		MAJ										BTVL1
Very Low Voltage		MAJ								ALM		VLA1
Voltage Channel Failure			MIN									VMF1
Voltage Duplicate ID		MAJ										MDP1
Voltage ID Not Configured		MAJ										MZD1

Table 10 Alarms, Alarm Relays and LEDs Assignments

Appendix F: SNMP

SNMP Overview

In addition to supporting the basic protocols (Telnet, HTTP, FTP, and SMTP) on TCP/IP, the Pulsar Edge supports conveying system alarm and control information to a Network Operation Center (NOC) using the Simple Network Management Protocol (SNMP). SNMP is the most popular protocol for managing diverse networks. Using SNMP to access management information data and retrieve alarm information can allow company personnel to more easily manage system performance and remotely find and solve system problems. A Pulsar Edge serves as an SNMP Agent. A SNMP Host system is used to communicate to a multitude of SNMP Agents. A number of SNMP Host packages are available such as HP OpenView, Castle Rock Computing SNMPc, IBM NetView, Lucent OneVision, and Sun Micro's Net Manager. OmniOn also provides a SNMP Host focused on the needs of the power engineer with its Manager product.

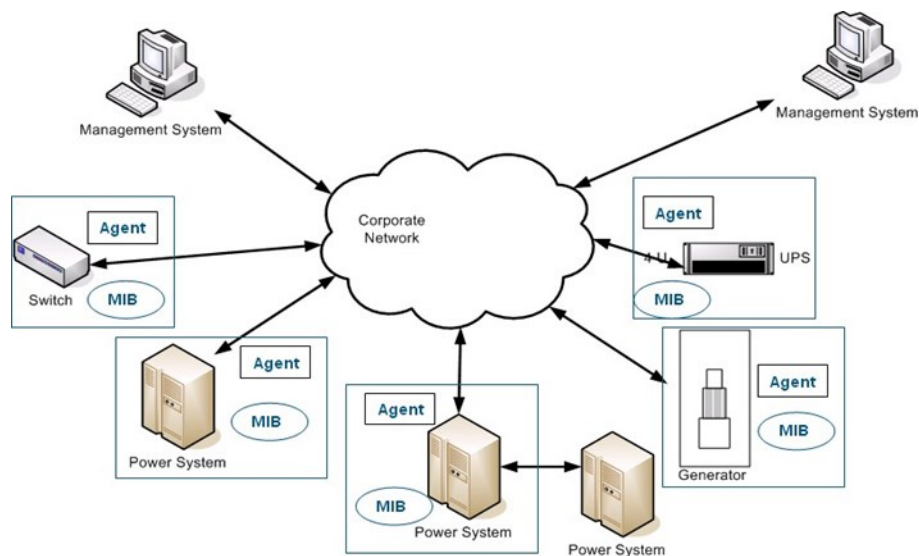

Simple Network Management Protocol is an application-layer protocol designed to facilitate the exchange of management information between network devices. There have been several releases of SNMP in its history and the Pulsar Edge implements a SNMPv2C Agent. SNMPv2C is backwards compatible with SNMPv1.

A key part of the SNMP protocol is the detailed Management Information Base (MIB) that describes all Agent variables that can be accessed. For the Pulsar Edge, this includes all the objects controlled or monitored in the system such as: rectifiers, converters, distribution monitoring cards, alarms, etc. Essentially, all elements described in the T1.317 protocol (see Appendix B) are available in SNMP. The MIB will be needed by any SNMP Host that wishes to communicate with the Pulsar Edge and can be retrieved at the “Design Tools and Download” link located at www.omnionpower.com

SNMP Operations

Interactions between the SNMP Host and the SNMP Agent can be any of four different types of commands: Reads, Writes, Traversal operations, and Traps. SNMP utilizes six operations to respond to the various SNMP Hosts: Get, GetNext, GetBulk, Set, Trap, and Inform. The Pulsar Edge implements the Get, GetNext, Set, and Trap operations.

Get - Allows the SNMP Host to retrieve a value from the SNMP Agent.

GetNext - Allows the SNMP Host to retrieve the next value in sequence from a table or list of variables in the SNMP Agent.

Set - Allows the SNMP Host to set a value within the SNMP Agent.

Trap - Used by the SNMP Agent (the power system controller) to asynchronously inform the SNMP Host of an event such as an alarm notification. Unlike the other operations, the trap does not require a response from the host. The SNMP Agent must be configured with appropriate addresses of the SNMP Host.

SNMP Configuration

SNMP functionality is always available. No enabling or disabling of the feature is required. Appropriate trap destinations and assignments of specific alarms must be configured for SNMP to properly send out Traps. Users can configure these SNMP parameters from the browser interface. They may also be configured from a Telnet command line interface.

Configuration of the IP addresses for Trap destinations is performed under the “Network” link under the main configuration “Settings” tab. The Pulsar Edge supports up to four different destinations for SNMP messages. Each destination (1 through 4) is configured with an IP address. The sample screen for this configuration follows.

The screenshot shows the 'Network Settings' page with the following configuration details:

Network Port 1		Network Port 2	
Current IP Address:	172.16.10.29		0.0.0.0
DHCP:	<input type="checkbox"/> DHCP Client		<input type="checkbox"/> static
IP Address:	<input type="text" value="0.0.0.0"/>		<input type="text" value="0.0.0.0"/>
Subnet Mask:	<input type="text" value="0.0.0.0"/>		<input type="text" value="0.0.0.0"/>
Default Router:	<input type="text" value="0.0.0.0"/>		<input type="text" value="0.0.0.0"/>
Domain Name:	<input type="text"/>		<input type="text" value="n/a"/>
DNS Server:	<input type="text" value="0.0.0.0"/>		<input type="text" value="n/a"/>
Host Name:	<input type="text"/>		<input type="text"/>
Mail Host:	<input type="text" value="0.0.0.0"/>		<input type="text" value="0.0.0.0"/>
Session Timeout:	<input type="text" value="0"/>		<input type="text" value="n/a"/>
Write Enabled:	<input checked="" type="checkbox"/> yes		<input type="checkbox"/> n/a

Trap Community Strings		
Description	IP Address	Community String
1 [SNMP Trap Destination 1]	<input type="text" value="0.0.0.0"/>	<input type="text" value="public"/>
2 [SNMP Trap Destination 2]	<input type="text" value="0.0.0.0"/>	<input type="text" value="public"/>
3 [SNMP Trap Destination 3]	<input type="text" value="0.0.0.0"/>	<input type="text" value="public"/>
4 [SNMP Trap Destination 4]	<input type="text" value="0.0.0.0"/>	<input type="text" value="public"/>

SET/GET Community Strings				
Description	IP Address	Community String	IP Addr. Mask	Write Enabled
1 [SNMP Community String 1]	<input type="text" value="0.0.0.0"/>	<input type="text" value="public"/>	<input type="text" value="255.255.255.255"/>	<input type="checkbox"/>
2 [SNMP Community String 2]	<input type="text" value="0.0.0.0"/>	<input type="text" value="public-write"/>	<input type="text" value="255.255.255.255"/>	<input checked="" type="checkbox"/>
3 [SNMP Community String 3]	<input type="text" value="0.0.0.0"/>	<input type="text" value="private"/>	<input type="text" value="255.255.255.255"/>	<input checked="" type="checkbox"/>

Individual alarms or events are assigned as Traps to one of the four specific SNMP destinations. Assignment of the alarm and events is performed under the “Alarm Notification” link under the main configuration “Settings” tab. The sample screen for this configuration follows.

Notify Settings																					
	ID	Sev.	Relay	LED	EMAIL				SNMP				PHONE				Delay				
					1	2	3	4	1	2	3	4	1	2	3	4		O	R	N	
System Alarms																					
High Ambient Temperature	AMTH1	MIN																			0s
Low Ambient Temperature	AMTL1	MIN																			0s
Auxiliary Major	AMJ1	MAJ																			0s
Alarm Test Active	ATA1	RO																			0s
Alarm Test Aborted	ATB1	RO																			0s
Real Time Clock Battery Low	BBL1	MIN																			0s
Configuration Changed	CCH1	RO																			0s
Clock Changed	CLC1	RO																			0s
ID Conflict	DID1	MAJ																			0s
Emergency Power Off	EPO1	MAJ																			0s
Excessive Login Attempts	EXL1	WRN																			0s
External Fuse Major	FAJ1	MAJ																			0s
External Fuse Minor	FAN1	MIN																			0s
History Cleared	HCL1	RO																			0s
Imminent Low V Shutdown	ISD1	MAJ																			0s
Password At Default	PFD1	RO																			0s
Processor Halt	PHT1	RO																			0s
Self Test Failed	STF1	MIN																			0s
Sense/Control Fuse	VSF1	MIN																			0s
ID Not Configured	ZID1	MAJ																			0s
Reserve Alarms																					
Battery On Discharge	BDA1	MAJ		ALM																	0s
Check Battery	BFA1	MIN																			0s
Very High Battery Temperature	BTXH1	MAJ																			0s
High Battery Temperature	BTHA1	MIN																			0s
Low Battery Temperature	BTLA1	MIN																			0s
Very Low Battery Temperature	BTVL1	MAJ																			0s
Open String	OSA1	MAJ																			0s
Reserve Time Low	RTL1	RO																			0s
Real-Time Reserve Low	RRTL1	RO																			0s
Battery Voltage Imbalance	SCD1	MIN																			0s
Thermal Probe Failure	TPA1	MIN																			0s
Thermal Probe Fail Safe	PFS1	MAJ																			0s
Very Low Voltage	VLA1	MAJ		ALM																	0s
Voltage Channel Failure	VMF1	MIN																			0s
Battery Test Active	BTA1	RO																			0s
Voltage Duplicate ID	MDP1	MAJ																			0s
Voltage ID Not Configured	MZD1	MAJ																			0s
Power Alarms																					
AC Fail	ACF1	MIN																			0s
Rectifier Current Limit	CLM1	RO																			0s
High Voltage	HFV1	MIN																			0s
Very High Voltage	HVA1	MAJ																			0s
Multiple AC Fail	MACF1	MAJ																			0s
Manual Off	MAN1	MIN																			0s
Multiple Manual Off	MMAN1	MAJ																			0s
Multiple Rectifier Fail	MFA1	MAJ																			0s
Rectifier Fail	RFA1	MIN																			0s
Rectifier Exp. Fail	RENF1	MAJ																			0s

Community Strings

SNMP Community Strings can serve as trap destinations as well as passwords or user IDs for network elements. The community name assigns an access environment for a set of SNMP Hosts or Agents using that community name. An SNMP Host or Agent within the community can be said to exist within the same administrative domain. Because devices that do not know the proper community name are precluded from SNMP operations, network management personnel can use the community name as a weak form of authentication. Community strings can be either read only or read/write. Having this capability provides further security by restricting the ability to alter the configuration of the managed device.

The Pulsar Edge defaults the value of the trap community string to “public” with read/write access. There are also up to three Set/Get community strings that can be used. These are defaulted as “public”, “public-write”, and “private” with the last two having read/write access.

This page intentionally left blank

Appendix G: Secure Protocols

Overview

Secured protocols are only supported by controllers identified with the Secured Protocols “S” in their model number - see Table 1.

Secured protocols include support for the SNMPv3, IPv6, HTTPS/SSL, SSH, and SFTP protocols.

Configuration

Reboot Required

Configuration changes involving IP addresses and protocol operational mode variable items require a reboot. Allow the controller to run for at least a minute and a half following a saved change to ensure the change has been saved to non-volatile memory before powering the unit down or any rebooting operation.

Security

Security related settings are found in Settings ► Communication ► Security. Administrative level log-in is required to edit these settings. The network related items are:

- Port behavior on failed login attempts (number of failed attempts allowed value of 3-10 attempts, time to lock the port value 0 to 5 minutes 1 minute increments).
- Password rules to encourage the use of strong passwords. These include minimum password length (3 to 15 characters) and requirements for the inclusion of different types of characters (≥ one upper case, ≥ one lower case, ≥ one number, and ≥ one special character).
- Individual protocol (network ports) enables to allow the blocking of non-secure protocols

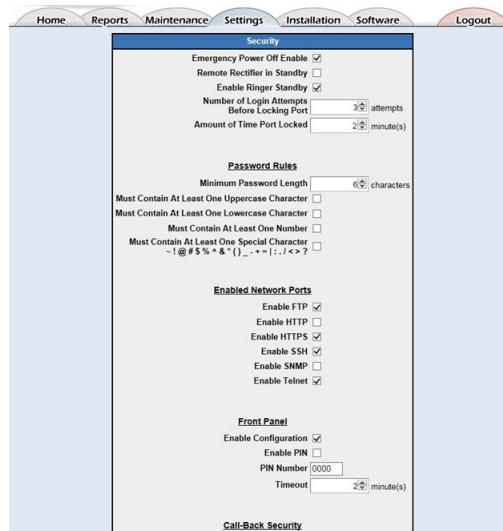

Figure 27: Security Configuration

NOTE: Depending on the factory default settings for the controller, unsecured network ports may be disabled.

Internet Protocols (IPv4 And IPv6)

Configuration settings for IPv4 and IPv6 are found on Network Settings: Settings ► Network Settings. The screen provides for IPv6 and IPv4 related settings.

Figure 28 shows Static DHCP selected in the IPv4 section of the given example and the basic required parameter settings for IPv4 (Static IP address, Subnet Mask, and Default Gateway Router IP address) are configured.

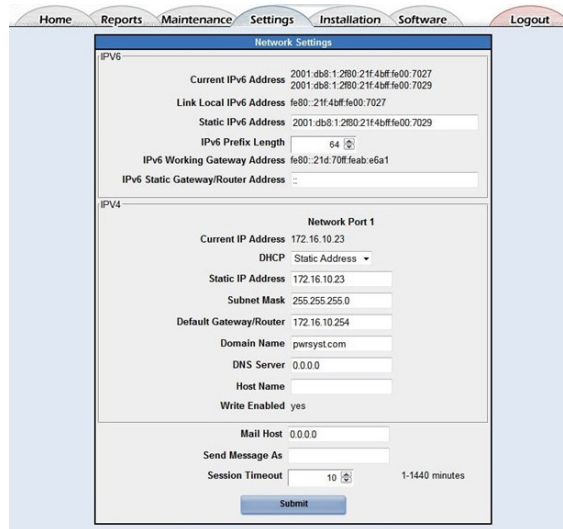

The screenshot shows the 'Network Settings' page with a navigation menu at the top (Home, Reports, Maintenance, Settings, Installation, Software, Logout). The IPv6 section includes fields for Current IPv6 Address, Link Local IPv6 Address, Static IPv6 Address, IPv6 Prefix Length (set to 64), IPv6 Working Gateway Address, and IPv6 Static Gateway/Router Address. The IPv4 section, labeled 'Network Port 1', includes fields for Current IP Address, DHCP mode (set to Static Address), Static IP Address, Subnet Mask, Default Gateway/Router, Domain Name, DNS Server, Host Name, Write Enabled (checked), Mail Host, Send Message As, and Session Timeout (set to 10 minutes). A 'Submit' button is at the bottom.

Figure 28: Network Settings for IPv4 and IPv6

IPv4

The controller is capable of simultaneous operation using IPv4 and IPv6 protocols. Using IPv4, the controller will utilize a single IPv4 address. This address will be assigned in one of 3 ways depending on the DHCP mode:

1. **DHCP mode Static:** In this configured mode, the controller uses a static IPv4 address assigned by the user. The user must supply a subnet mask and a router address.
2. **DHCP mode Client:** In this configured mode, the controller uses a dynamic IPv4 address assigned by a DHCP server on the network.
3. **DHCP mode Server:** In this configured mode, the controller will automatically assign a predefined IPv4 address of 192.168.2.11 to a PC plugged directly into its network port connection. For this reason, the controller MUST NOT be connected to a network while operating in this mode.

IPv6

The controller supports IPv6. Operating with IPv6, the controller can have multiple IPv6 addresses. It can have Link Local Address and multiple Global Unicast Addresses. These items are shown in the top section of the Network Settings screen.

The controller will have a single Link Local address. This Link Local address is automatically generated by the controller based on its MAC address. It is displayed in the Network Settings screen. The link local address can only be used on the local link (subnet) and will not be routed through the network. Browsers will not accept a link local address in a URL.

The controller may also have one or more Global Unicast Address. One of these addresses can be manually entered by the user. Entry of this IPv6 address is in the “Static IPv6 Address” field shown. Another Global address can be automatically generated by the controller using the SLAAC protocol. The SLAAC protocol allows routers to send a router advertisement messages. These messages will supply the router address, the link prefix (subnet) and network options. One of these network options, the autonomous address-configuration flag, will instruct the controller to generate a Global Unicast Address based on the router prefix and the controller’s MAC address. This IPv6 address is displayed as the “Current IPv6 Address”.

HTTPS (SSL)

The controller supports the Hyper-Text Transfer Protocol with SSL Encryption. It is capable of supporting browser access using HTTP and HTTPS. The standard controller is shipped with HTTP enabled and HTTPS disabled. However, specific customer configurations requiring only secured protocols will have HTTP access disabled and HTTPS access enabled.

The desired HTTP protocol access is selected by prepending the URL address with the respective “http://” or “https://” to in the browser. If the controller is accessed using its IPv4 address with HTTPS, the browser will issue a screen indicating a problem with the website’s security certificate as shown below.

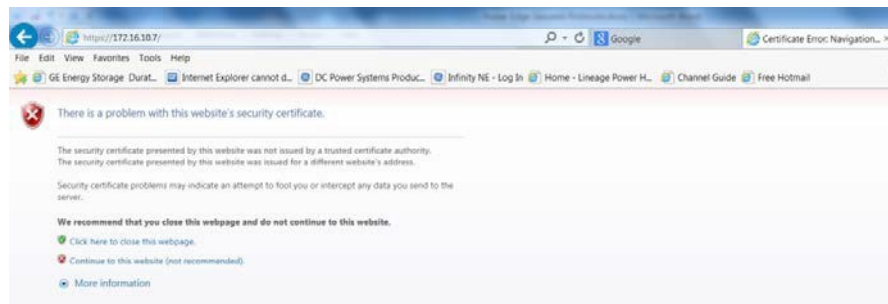

Figure 29: Security Problem Screen Using Explorer

In this case, select “Continue to this website (not recommended)” and the controller login screen will be presented. Continue to Login into the controller using the appropriate passwords (lineage, super-user, and administrator by default). The browser will complain about a mismatched address in the certificate if the controller is accessed using its IPv4 address for HTTPS. Clicking on the Certificate error screen shows the error as seen below. The controller will be fully accessible using IPv4 and HTTPS with this mismatched address.

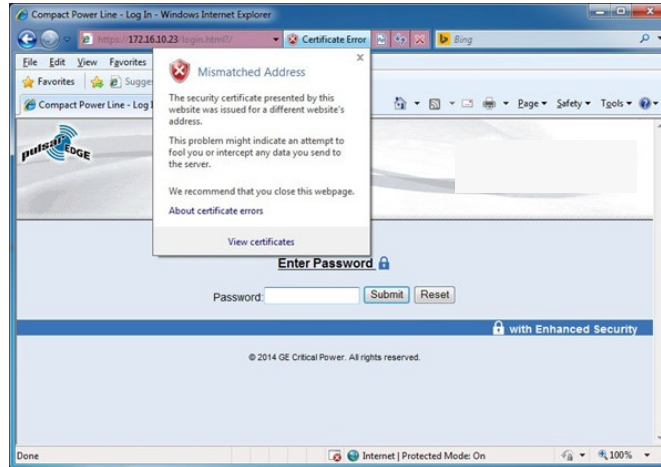

Figure 30: Mismatched Address Certificate Error Screen

To enable HTTPS connectivity to the controller without browser warnings in IPv6 the following procedures must be followed:

1. Contact OmniOn Critical Power at the 24/7 technical support contacts at either techsupport@omnionpower.com or 1-877-546-3243 or 1-972-244-9288 (DC Systems Option 2) for the certificate file.
2. Change the file extension to ".crt"
3. Right click on the certificate file ASDC_2048.crt and select: "Install Certificate"
4. When prompted select: "Place all certificates in the following store"
5. Browse to select: "Trusted root certification authorities"

The device certificate created by the controller identifies the controller by its IPv6 address. Whenever the IP address of a controller is changed, it is necessary to reboot the controller. Allow about a minute and a half for all the changes to be stored prior to rebooting. Upon reboot, the controller will create a device certificate for the new IP address. This process may take several minutes. Now the "https:" prepended URL can be used to access error free connection. Note: an IPv6 address must be enclosed in [] when in a URL. Sample web screen follows.

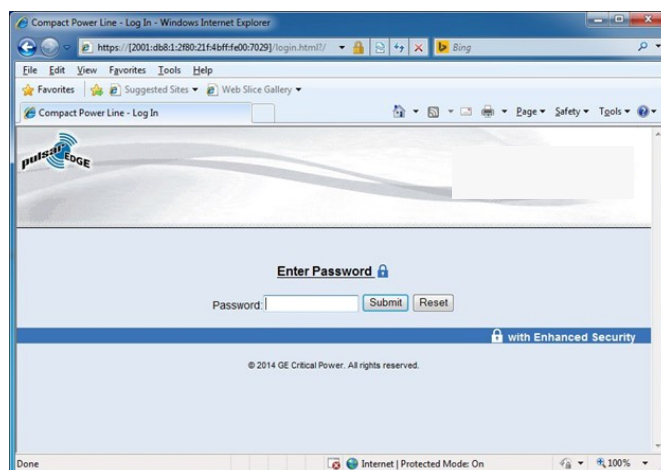

Figure 31: HTTPS Connectivity Over IPv6 Controller Login Screen

SNMP

In addition to supporting the basic protocols on TCP/IP, the controller supports conveying system alarm and control information to a Network Operation Center (NOC) using the Simple Network Management Protocol (SNMP). The controller implements the secured SNMPv3 as well as the SNMPv2C agent that is backwards compatible with SNMPv1. The various configuration items for the protocols can be found in the Settings ► Communication ► SNMP web screen depicted below.

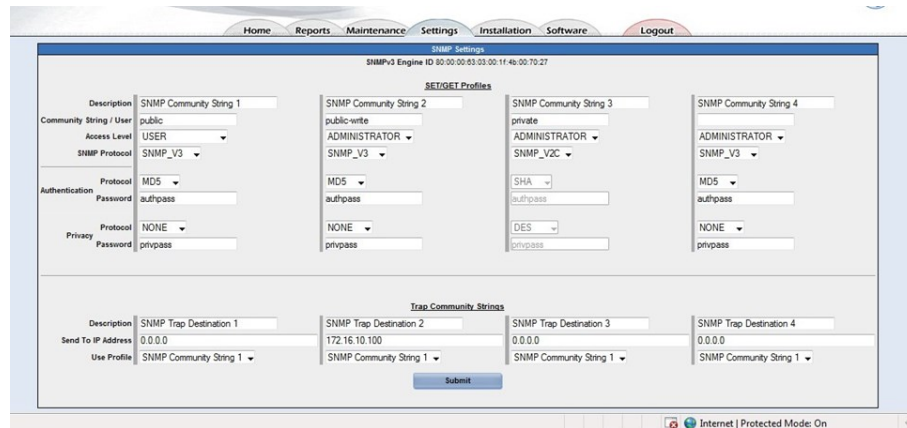

Figure 32: SNMP Settings Screen

For security reasons the SNMPv1/v2c community string and SNMPv3 user information can only be modified when logged in as administrator.

The controller has four SET/GET profiles that can be used as either SNMPv1/v2c community strings or SNMPv3 users. The Community String/User field is the value of community string or username that will be accepted by the controller. Each one of these values must be unique (or blank). The SNMP Protocol field determines how each is used. The Access Level (User, Super-User, and Administrator) field determines which SNMP operations are valid and the scope for each. The choices are:

- USER - has read-only access (SNMP GET operation) to data (OIDs) within the controller MIB
- SUPER-USER - has read and write access (SNMP SET and GET operations) to OIDs within the controller MIB
- ADMINISTRATOR - has read and write access to all OIDs supported by the controller

SNMPv3 users have additional protocol and password fields to support authentication and privacy. (These fields are only accessible if the SNMPv3 protocol is selected).

Authentication protocols are NONE, MD5 and SHA. Privacy protocols are NONE, DES and AES 128-bit.

Whenever the SET/GET profiles are modified the controller will require about 15 seconds before the changes take effect. This allows the controller type to perform the calculations necessary to create new crypto keys.

Four Trap Community String entries allow the user to specify a target IP address (IPv4 or IPv6) for alarm notifications (Traps) and one of the SET/GET Profiles to be used with the trap.

SFTP

The controller implements the SSH File Transfer Protocol (also Secure File Transfer Protocol, or SFTP) to provide file access, file transfer, and file management functionalities over any reliable data stream. WinSCP, an open source free SFTP client, FTP client, WebDAV client and SCP client for Windows, was used to test the file transfer capability between the controller and a remote computer. This software can be downloaded at <http://winscp.net/eng/download.php>.

By default WinSCP attempts to use a temporary file to allow file transfers to be interrupted and resumed. The controller's file system does not allow the creation of temporary files, so the feature must be disabled in WinSCP. Disable this feature by going to Options ► Preferences ► Endurance in WinSCP and check the disable for the “transfer resume/transfer to temporary file”. Sample WinSCP screen shots follow.

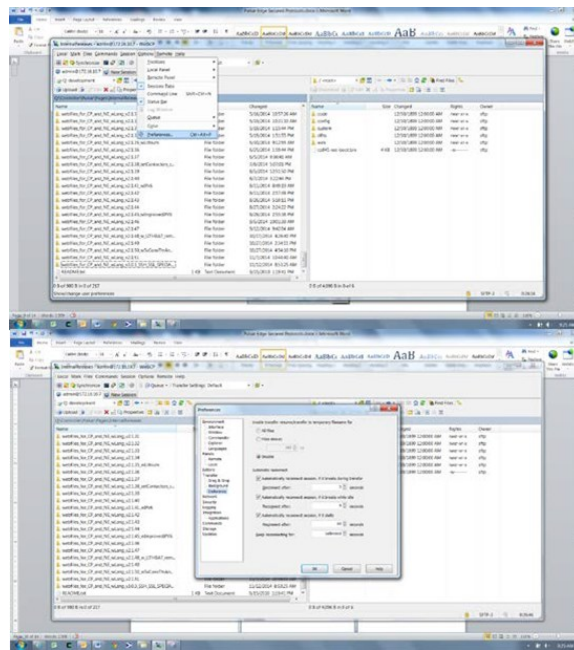

Figure 33: Sample WinSCP Configuration Screen For Disable

When logging into the controller using WinSCP, as with FTP, the username is not validated unless the controller has the “User Name and Password” login method enabled (Settings ► Passwords).

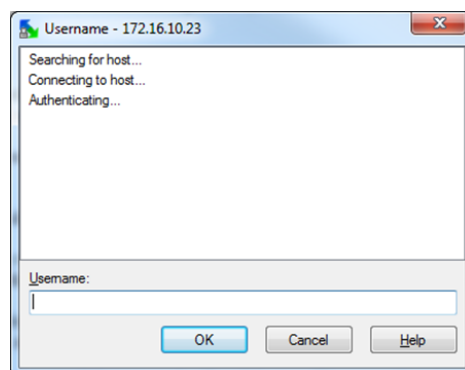

Figure 9 Pulsar Edge Status Menu

When connecting to a controller for the first time WinSCP will alert the user to store the controller's security key in the key cache. Press Yes. This key will remain valid until the controller's IP address is modified.

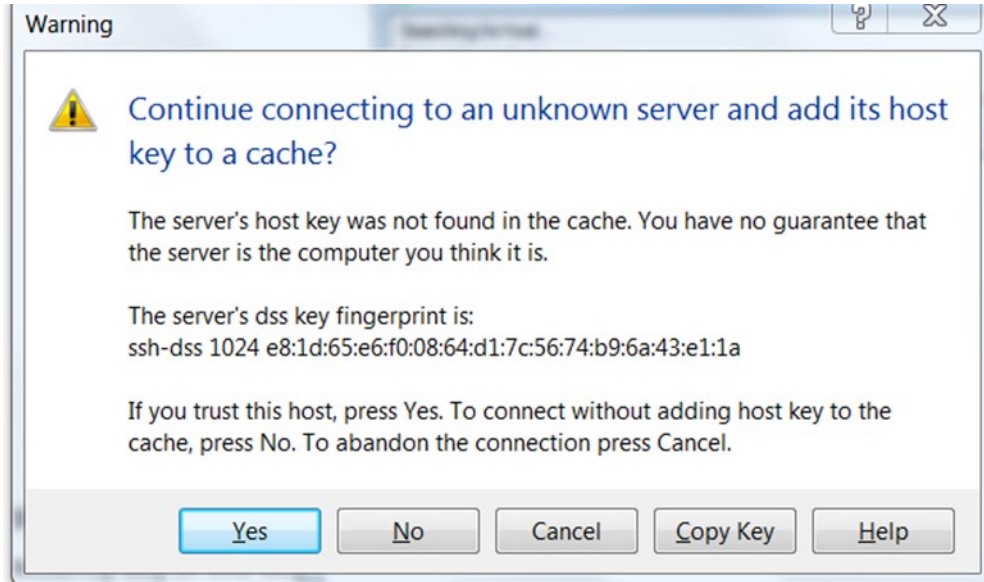
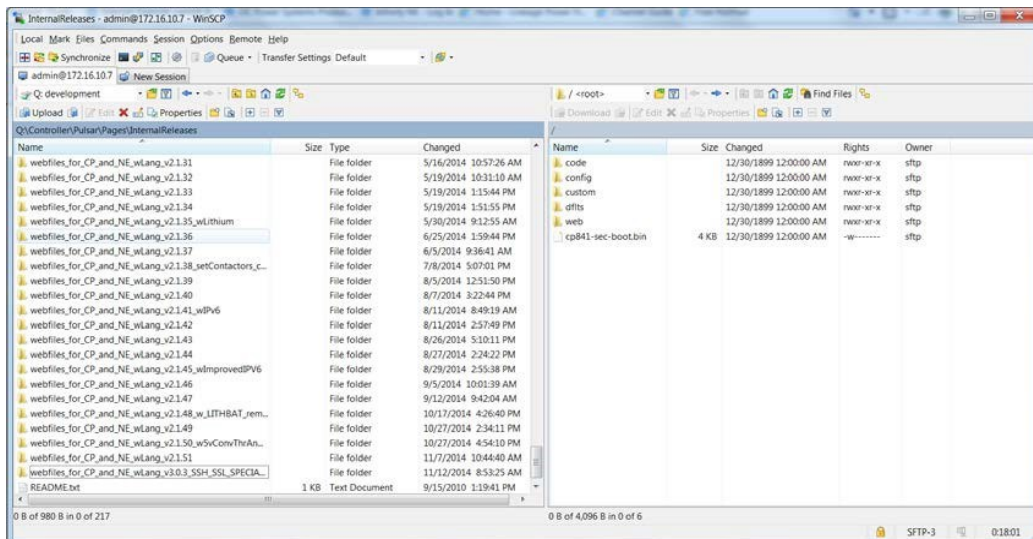

Figure 35: WinSCP Security Key Warning Screen

Following is a sample screen of using a WinSCP SFTP connection to a Galaxy Pulsar Edge controller.



SSH

The controller supports the Secure Shell (SSH) cryptographic network protocol for secure data communication, remote command-line login, remote command execution, and other secure network services between itself and a networked computer. It is a replacement for Telnet that offers encryption. The controller's SSH implementation has been tested using PuTTY. PuTTY is an SSH and telnet client, developed originally by Simon Tatham for the Windows platform. It is open source software that is available with source code and is developed and supported by a group of volunteers. Putty can be downloaded at <http://www.putty.org/>. A typical download is the "putty.exe" executable that covers the Telnet and SSH client.

When connecting to the controller for the first time, PuTTY will alert the user to store the controller's security key in the key cache (sample screen below). Select "Yes", enter a login, and the controller password, to access the SSH server (the controller). This key will remain valid until the controller's IP address is modified.

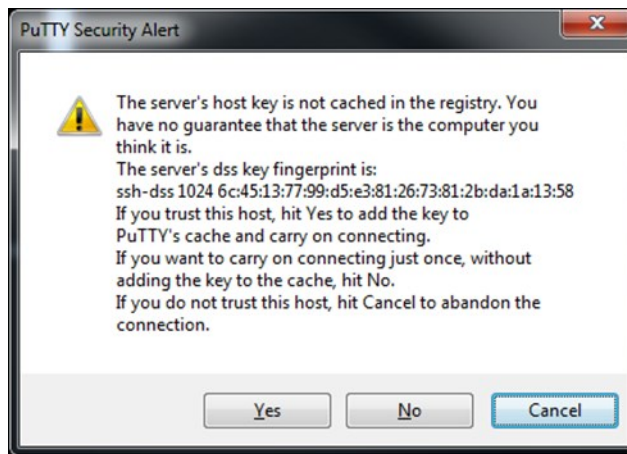

Figure 36: PuTTY Security Key Warning Screen

Below is a sample controller's screen once the controller's SSH Server has been accessed. Standard T1.317 commands can be used.

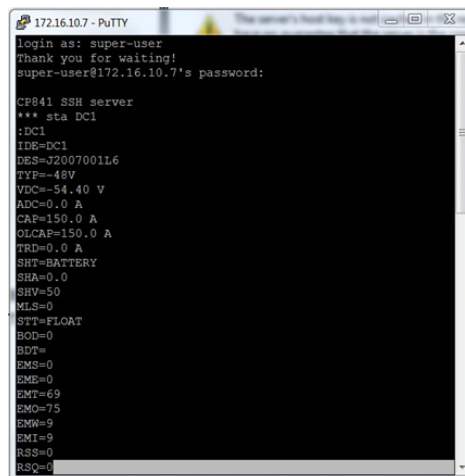

Figure 37: PuTTY SSH Login Example Screen

Revision

Revision	Description	Date
4.5	Updated as per template	10/14/2021
4.6	Updated page footer	4/5/2023
4.7	Updated as per OmniOn template	11/10/2023
4.8	Updated User password on pages 28 and 31	01/17/2024

OmniOn Power Inc.

601 Shiloh Rd.
Plano, TX USA

omnionpower.com

We reserve the right to make technical changes or modify the contents of this document without prior notice. OmniOn Power does not accept any responsibility for errors or lack of information in this document and makes no warranty with respect to and assumes no liability as a result of any use of information in this document.

We reserve all rights in this document and in the subject matter and illustrations contained therein. Any reproduction, disclosure to third parties or utilization of its contents – in whole or in parts – is forbidden without prior written consent of OmniOn Power. This document does not convey license to any patent or any intellectual property right. Copyright© 2023 OmniOn Power Inc. All rights reserved.