

**183 SERIES INDICATOR LIGHTS**

*Caps Ordered Separately, See Below*

PART NO.	CAP	FIG
183-9730-14-602	ALL	1
183-9830-14-604	ALL	2

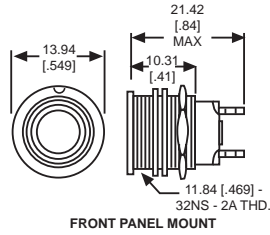

Fig. 1

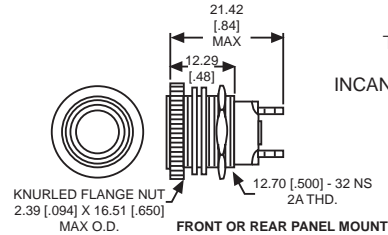

Fig. 2

Uses:  
T-1 3/4 MIDGET  
FLANGE BASE  
INCANDESCENT LAMP

**184, 186, 187, 188, 302, 304, 305 & 307 SERIES CAPS**

**1/2" SQUARE**

CAP PART NO.	COLOR	FIG
184-1871	RED	3
184-1872	GREEN	3
184-1873	YELLOW	3
184-1875	WHITE	3

**1/2" ROUND**

CAP PART NO.	COLOR	FIG
186-1471	RED	7
186-1472	GREEN	7
186-1473	YELLOW	7
186-1475	WHITE	7

**5/8" SQUARE†**

CAP PART NO.	COLOR	FIG
304-1871	RED	4
304-1872	GREEN	4
304-1873	YELLOW	4
304-1875	WHITE	4

**5/8" ROUND†**

CAP PART NO.	COLOR	FIG
305-1471	RED	8
305-1472	GREEN	8
305-1473	YELLOW	8
305-1475	WHITE	8

**3/4" SQUARE**

CAP PART NO.	COLOR	FIG
187-1871	RED	5
187-1872	GREEN	5
187-1873	YELLOW	5
187-1875	WHITE	5

**3/4" ROUND**

CAP PART NO.	COLOR	FIG
188-1471	RED	9
188-1472	GREEN	9
188-1473	YELLOW	9
188-1475	WHITE	9

**3/4" SQUARE†**

CAP PART NO.	COLOR	FIG
307-1871	RED	6
307-1872	GREEN	6
307-1873	YELLOW	6
307-1875	WHITE	6

**3/4" x 1" RECTANGULAR†**

CAP PART NO.	COLOR	FIG
302-3471	RED	10
302-3472	GREEN	10
302-3473	YELLOW	10
302-3475	WHITE	10

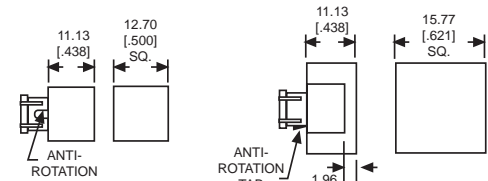

Fig. 3

Fig. 4

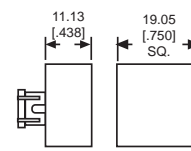

Fig. 5

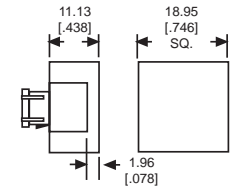

Fig. 6

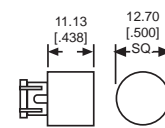

Fig. 7

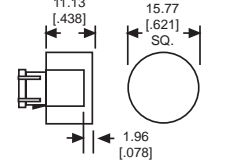

Fig. 8

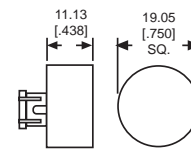

Fig. 9

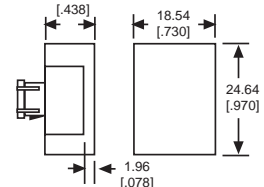

Fig. 10

Please contact factory for legend information available on Figures 3 thru 10

**534 SERIES CAP KITS**

**3/4" x 1" LEGEND KITS†**

KIT PART NO.	LENS/FILTER COLOR	FIG
534-0701-030	RED, GREEN, AMBER, BLUE/NONE	11
534-0701-037	CLEAR/NONE	11
534-0701-537	CLEAR/RED, GREEN, AMBER, BLUE	11

Legends provided by Dialight Stocking Distributors

† Feature fingertip grip for use with snap-in mount switches and indicators

Material & Finish: Base, Clear anodized aluminum;  
Cap, High temperature scratch-resistant plastic

Neon and incandescent lamp information on Pages 35 and 36.

Dimensions in mm [inches]

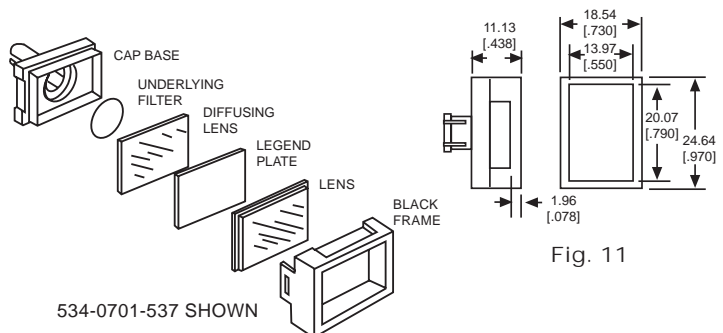

Fig. 11

534-0701-537 SHOWN

# Mouser Electronics

Authorized Distributor

Click to View Pricing, Inventory, Delivery & Lifecycle Information:

[Dialight:](#)

[534-0701-537](#) [534-0701-030](#) [534-0701-037](#) [186-1472](#) [188-1473](#) [302-3473](#) [307-1872](#) [305-1473](#) [186-1475](#) [305-1472](#) [187-1872](#) [188-1472](#) [188-1475](#) [187-1875](#) [184-1871](#) [184-1872](#) [187-1871](#) [184-1873](#) [187-1873](#)