

1-1564526-1 ✓ ACTIVE

AMP | Heavy Duty Sealed Connector Series

TE Internal #: 1-1564526-1

Housing for Male Terminals, Wire-to-Wire, 18 Position, 4 mm [.157 in] Centerline, Sealable, Black, Wire & Cable, Heavy Duty Sealed Connector Series

[View on TE.com >](#)



Connectors > Automotive Connectors > Automotive Housings > Heavy Duty Sealed Connector Series Housings

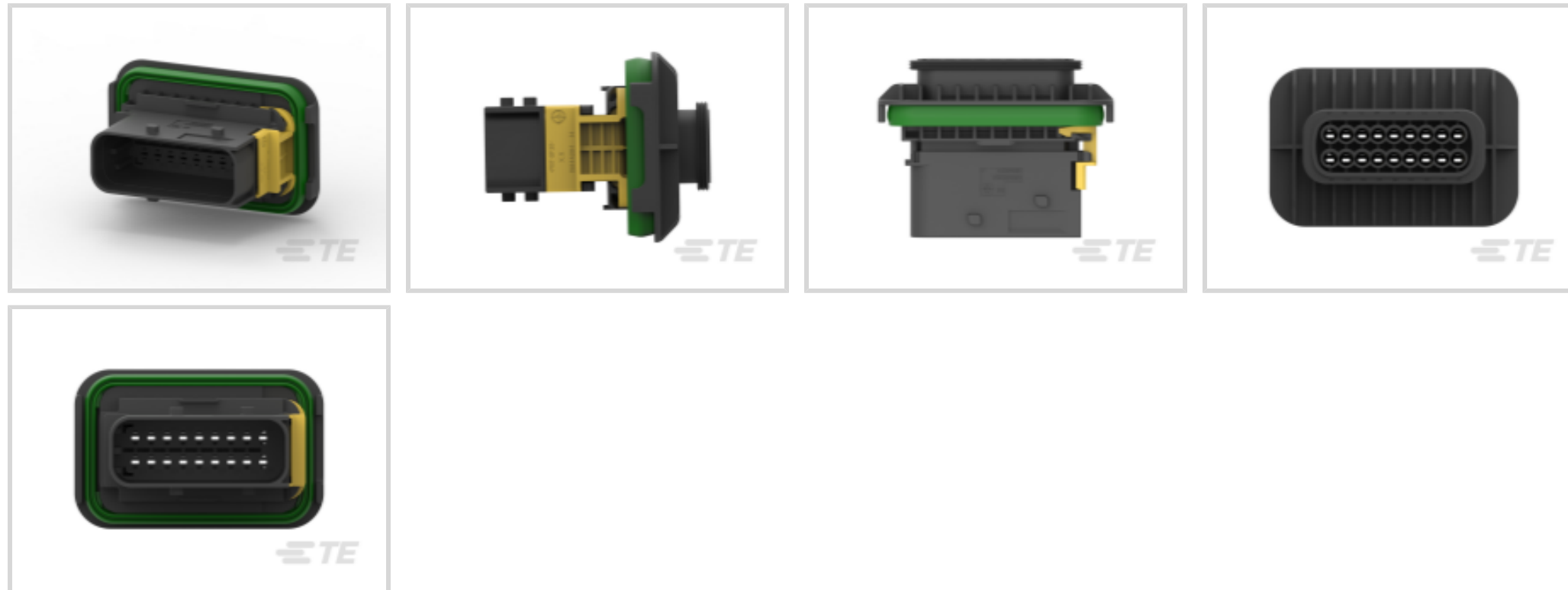

Connector System: **Wire-to-Wire**

Number of Positions: **18**

Connector & Housing Type: **Housing for Male Terminals**

Centerline (Pitch): **4 mm [.157 in]**

Sealable: **Yes**

[All Heavy Duty Sealed Connector Series Housings \(204\)](#)

Features

Product Type Features

Mixed & Hybrid Connector	No
Connector Shape	Rectangular
Connector System	Wire-to-Wire
Connector & Housing Type	Housing for Male Terminals
Sealable	Yes
Connector & Contact Terminates To	Wire & Cable
Primary Locking Feature	On the Terminal

Configuration Features

Number of Positions	18
Number of Rows	2

Electrical Characteristics

Operating Voltage	60 VDC
-------------------	--------



Body Features

Cable Exit Angle	180°
Primary Product Color	Black
Connector & Keying Code	A

Contact Features

Contact Size	1.6mm
Contact Type	Tab
Mating Tab Width	1.6 mm[.063 in]
Contact Current Rating (Max)	10 A

Mechanical Attachment

Terminal Position Assurance	No
Strain Relief	Without
Mating Alignment Type	Keyed
Mating Alignment	With
Connector Mounting Type	Cable Mount (Free-Hanging)

Housing Features

Housing Material	PBT GF30
Centerline (Pitch)	4 mm[.157 in]

Dimensions

Connector Height	47.1 mm[1.854 in]
Product Width	39.8 mm[1.567 in]
Product Length	62.5 mm[2.461 in]
Row-to-Row Spacing	6.8 mm, 7.25 mm, 7.7 mm, 7.9 mm, 9.5 mm[.268 in][.285 in][.303 in][.311 in][.374 in]

Usage Conditions

Operating Temperature (Max)	140 °C[284 °F]
Operating Temperature Range	-40 – 140 °C[-40 – 284 °F]

Operation/Application

Circuit Application	Power
---------------------	-------

Industry Standards

Degree of Protection	IP67
UL Flammability Rating	UL 94V-0



Packaging Features

Packaging Quantity	150
Packaging Method	Carton

Other

Serviceable	Yes
Connector Position Assurance Capable	No

Product Compliance

[For compliance documentation, visit the product page on TE.com>](#)

EU RoHS Directive 2011/65/EU	Compliant
EU ELV Directive 2000/53/EC	Compliant
China RoHS 2 Directive MIIT Order No 32, 2016	No Restricted Materials Above Threshold
EU REACH Regulation (EC) No. 1907/2006	Current ECHA Candidate List: JUNE 2024 (241) Candidate List Declared Against: JUNE 2024 (241) Does not contain REACH SVHC
Halogen Content	Not Low Halogen - contains Br or Cl > 900 ppm.
Solder Process Capability	Not applicable for solder process capability

Product Compliance Disclaimer

This information is provided based on reasonable inquiry of our suppliers and represents our current actual knowledge based on the information they provided. This information is subject to change. The part numbers that TE has identified as EU RoHS compliant have a maximum concentration of 0.1% by weight in homogenous materials for lead, hexavalent chromium, mercury, PBB, PBDE, DBP, BBP, DEHP, DIBP, and 0.01% for cadmium, or qualify for an exemption to these limits as defined in the Annexes of Directive 2011/65/EU (RoHS2). Finished electrical and electronic equipment products will be CE marked as required by Directive 2011/65/EU. Components may not be CE marked. Additionally, the part numbers that TE has identified as EU ELV compliant have a maximum concentration of 0.1% by weight in homogenous materials for lead, hexavalent chromium, and mercury, and 0.01% for cadmium, or qualify for an exemption to these limits as defined in the Annexes of Directive 2000/53/EC (ELV). Regarding the REACH Regulation, the information TE provides on SVHC in articles for this part number is based on the latest European Chemicals Agency (ECHA) 'Guidance on requirements for substances in articles' posted at this URL: <https://echa.europa.eu/guidance-documents/guidance-on-reach>

Compatible Parts



TE Part # CAT-H3399-SL34
Heavy Duty Sealed Connector Series
Fixing Slides



TE Part # CAT-H3399-B128
Heavy Duty Sealed Connector Series
Backshells



TE Part # 2112297-1
PROTECTION CAP, GROUP E, ASSY



TE Part # 964972-1
EINZELLEITERDICHTUNG



TE Part # 1564411-8
SLIDE, TAB HSG GROUP E



TE Part # 1-1563759-1
18POS, AMP MCP1.5K, REC HSG, ASSY



TE Part # CAT-T4827-T273
TIMER, RECEPTACLE AND TAB



TE Part # 2-964269-2
TAB A 1.6x0.6 CONTACT CF SWS Ag

Also in the Series | **Heavy Duty Sealed Connector Series**

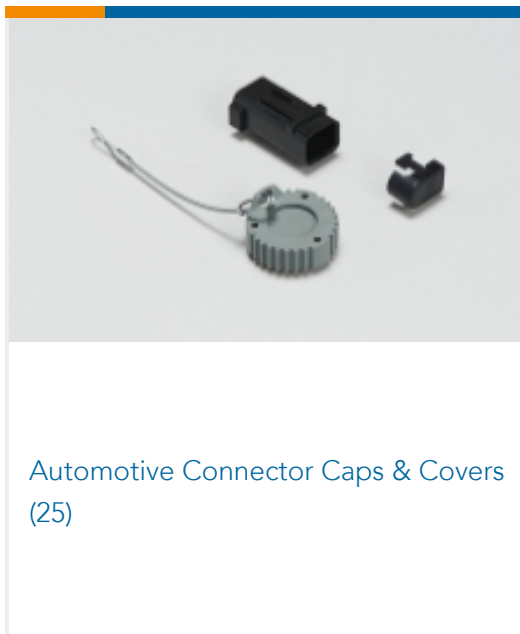

Automotive Connector Caps & Covers
(25)

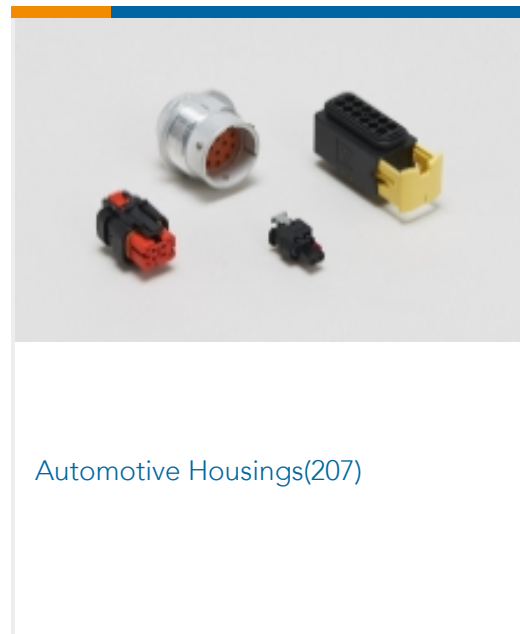

Automotive Housings(207)

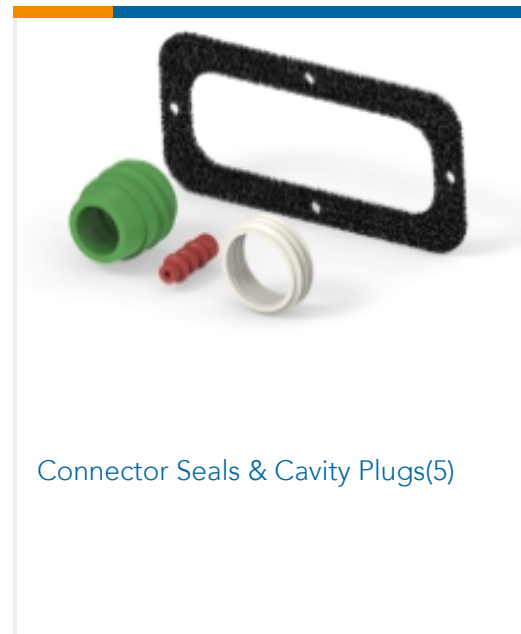

Connector Seals & Cavity Plugs(5)

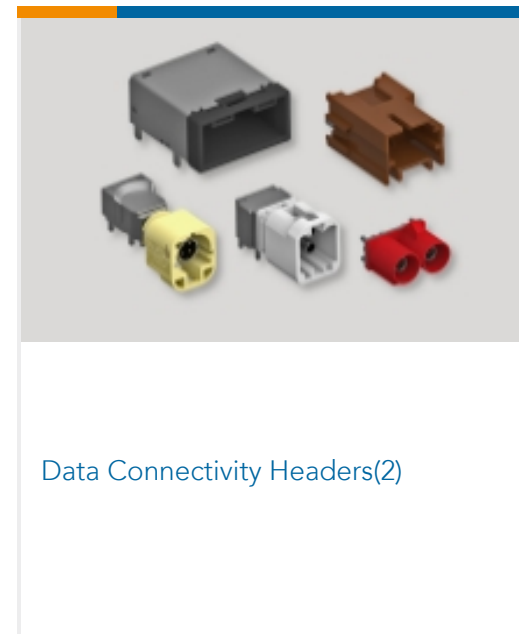

Data Connectivity Headers(2)



Data Connectivity Housings(16)

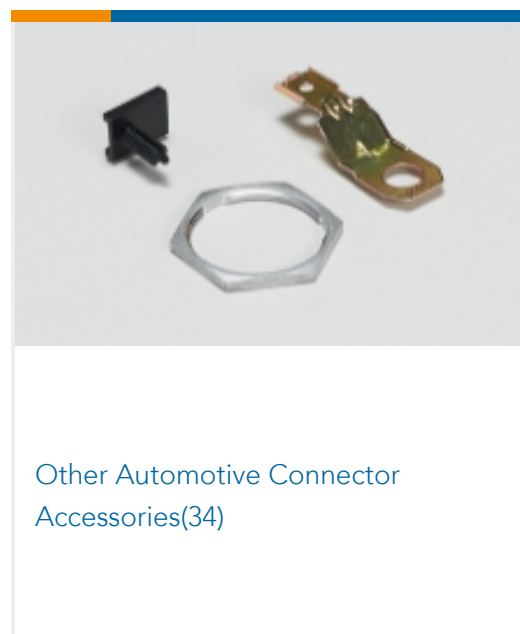

Other Automotive Connector
Accessories(34)



PCB Headers & Receptacles(1)

Customers Also Bought



TE Part #3-1564416-1
8POS, TAB 1.6X0.6, TAB HSG, ASSY

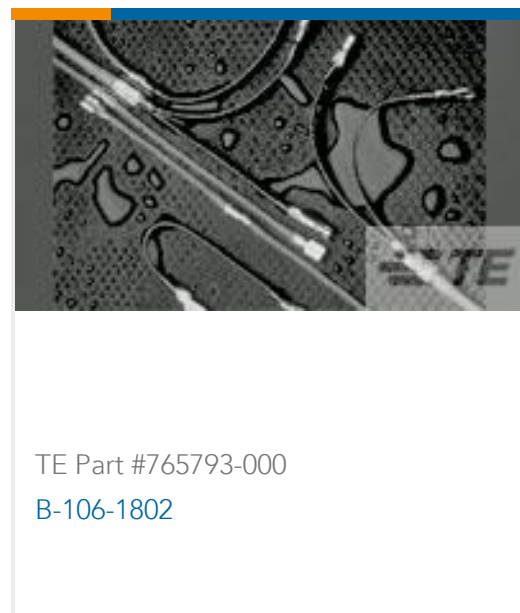

TE Part #765793-000
B-106-1802



TE Part #1-2355198-1
HVP800 2P HEADER ASSY



TE Part #1-2381216-3
48POS, MCON 1.2, TAB HSG ASSY, SLD,
COD J



Documents

Product Drawings

18POS, TAB 1.6X0.6, TAB HSG, ASSY

English

CAD Files

Customer View Model

ENG_CVM_CVM_1-1564526-1_H.2d_dxf.zip

English

3D PDF

3D

Customer View Model

ENG_CVM_CVM_1-1564526-1_H.3d_igs.zip

English

Customer View Model

ENG_CVM_CVM_1-1564526-1_H.3d_stp.zip

English

By downloading the CAD file I accept and agree to the [Terms and Conditions](#) of use.

Datasheets & Catalog Pages

HDSCS Catalog

English

ICT Terminals and Connectors Catalogue

English

CONNECTOR SELECTOR

English

Product Specifications



[Application Specification](#)

English

[Application Specification](#)

English

[Agency Approvals](#)

[UL Report](#)

English