

PERFORMANCE PLASTIC PACKAGE ULTRA MINIATURE PURE SILICON™ CLOCK OSCILLATOR

ASFLMP



Life Size
5.0 x 3.2 x 0.85 mm

ASFLMP



RoHS/RoHS II compliant

Moisture Sensitivity Level- MSL 1

FEATURES:

- Ultra Miniature Pure Silicon™ Clock Oscillator
- High Performance MEMS Technology by Discera
- Low Power Consumption for high speed communication
- Exceptional Stability Over Temp. at -40 to +85°C, ±15ppm
- Extended Automotive Grade Temp. stability at -55 to +125°C, ±25ppm
- MIL-STD-883 shock and vibration compliant
- Durable QFN Plastic Compact Packaging
- Standby or Disable Tri-state function
- Low jitter (Period jitter RMS and Phase jitter RMS)
- High power supply noise reduction, -50dBc

APPLICATIONS:

- Storage Area Networks (SATA, SAS, Fiber Channel)
- Passive Optical Networks (EPON, 10G-EPON, GPON, 10G-PON)
- Ethernet (1G, 10GBASE-T, KR/LR/SR, FCoE)
- PCI Express
- Display port

STANDARD SPECIFICATIONS:

Common Key Electrical Specifications – CMOS, LVPECL, LVDS, and HCSL

| Parameters | Minimum | Typical | Maximum | Units | Notes | |
|--------------------------------------|--|---------|---------|----------|--------------------------------|------------------------------------|
| Frequency Range | CMOS | 2.3000* | | 170.0000 | MHz | -20 ~ +70°C -40 ~ +85°C |
| | CMOS | 3.3000* | | 170.0000 | | -40 ~ +105°C -55 ~ +125°C |
| | LVPECL | 2.3000* | | 460.0000 | | Commercial, Industrial temp. range |
| | LVDS | 2.3000* | | 460.0000 | | Commercial, Industrial temp. range |
| | HCSL | 2.3000* | | 460.0000 | | Commercial, Industrial temp. range |
| Operating Temperature | -20 | | +70 | °C | See options | |
| Storage Temperature | -55 | | +150 | °C | | |
| Overall Frequency Stability | -50 | | +50 | ppm | See options | |
| Supply Voltage (Vdd) | +2.25 | | +3.6 | V | | |
| Startup Time | | | 5 | ms | | |
| Enable Time | | | 20 | ns | STD (Tri-state) | |
| | | | 5 | ms | PD option (Power Down) | |
| Disable Time | | | 5 | ns | | |
| Disable Current | | 20 | 22 | mA | STD (Tri-state) | |
| | | | 0.095 | | PD option (Power Down) | |
| Tri-state Function (Standby/Disable) | "1" (VIH ≥ 0.75*Vdd) or Open: Oscillation "0" (VIL < 0.25*Vdd) : Hi Z | | | V | 40kΩ pull-up resistor embedded | |
| Aging | -5.0 | | +5.0 | ppm | First year | |

* For 2.3000MHz < F0 < 9.9999MHz, 6-8 weeks lead-time applies

Key Electrical Specifications – CMOS

| Parameters | Minimum | Typical | Maximum | Units | Notes |
|--|-----------------|---------------------|---------------------|-------|-----------------------|
| Supply Current (I _{dd}) | | 31 | 35 | mA | CL=15pF, 125MHz |
| Output Logic Level | V _{OH} | 0.9*V _{dd} | | V | I=±6mA |
| | V _{OL} | | 0.1*V _{dd} | V | |
| Rise Time | Tr | 1.1 | 2.0 | ns | CL=15pF |
| Fall Time | Tf | 1.3 | 2.0 | ns | 20% to 80% |
| Duty Cycle | | 45 | 55 | % | |
| Integrated Phase Jitter (J _{PH}) | | 0.30 | 2 | ps | 200kHz ~ 20MHz@125MHz |
| | | 0.38 | 2 | | 100kHz ~ 20MHz@125MHz |
| | | 1.70 | 2 | | 12kHz ~ 20MHz@125MHz |
| Period Jitter RMS (J _{PER}) | | 3.0 | | ps | |

REVISED: 12.6.2017

PERFORMANCE PLASTIC PACKAGE ULTRA MINIATURE PURE SILICON™ CLOCK OSCILLATOR

ASFLMP



Life Size
5.0 x 3.2 x 0.85 mm

ASFLMP



RoHS/RoHS II compliant

Key Electrical Specifications – LVPECL

| Parameters | | Minimum | Typical | Maximum | Units | Notes |
|--|----------|---------------|---------|---------------|-------|-------------------------------|
| Supply Current (I_{dd}) | | | 56.5 | 58 | mA | RL=50Ω |
| Output Logic Level | V_{OH} | $V_{dd}-1.08$ | | | V | RL=50Ω |
| | V_{OL} | | | $V_{dd}-1.55$ | V | |
| Peak to Peak Output Swing (V_{pp}) | | | 800 | | mV | Single ended |
| Rise Time | T_r | | 250 | | ps | RL=50Ω , CL=0pF 20% to 80% |
| Fall Time | T_f | | 250 | | | |
| Duty Cycle | | 48 | | 52 | % | Differential |
| Integrated Phase Jitter (J_{PH}) | | | 0.25 | 2 | ps | 200kHz ~ 20MHz @156.25MHz |
| | | | 0.38 | 2 | | 100kHz ~ 20MHz @156.25MHz |
| | | | 1.70 | 2 | | 12kHz ~ 20MHz @156.25MHz |
| Period Jitter RMS (J_{PER}) | | | 2.5 | | ps | |

Key Electrical Specifications – LVDS

| Parameters | | Minimum | Typical | Maximum | Units | Notes |
|--|-------|---------|---------|---------|-------|-------------------------------|
| Supply Current (I_{dd}) | | | 29 | 32 | mA | RL=100Ω |
| Output Offset Voltage (V_{OS}) | | 1.125 | | 1.4 | V | RL=100Ω differential |
| Delta Offset Voltage (ΔV_{OS}) | | | | 50 | mV | |
| Peak to Peak Output Swing (V_{pp}) | | | 350 | | mV | Single ended |
| Rise Time | T_r | | 200 | | ps | RL=50Ω , CL=2pF 20% to 80% |
| Fall Time | T_f | | 200 | | | |
| Duty Cycle | | 48 | | 52 | % | Differential |
| Integrated Phase Jitter (J_{PH}) | | | 0.28 | 2 | ps | 200kHz ~ 20MHz @156.25MHz |
| | | | 0.40 | 2 | | 100kHz ~ 20MHz @156.25MHz |
| | | | 1.70 | 2 | | 12kHz ~ 20MHz @156.25MHz |
| Period Jitter RMS (J_{PER}) | | | 2.5 | | ps | |

Key Electrical Specifications – HCSL

| Parameters | | Minimum | Typical | Maximum | Units | Notes |
|--|----------|---------|---------|---------|-------|-------------------------------|
| Supply Current (I_{dd}) | | | 40 | 42 | mA | RL=50Ω |
| Output Logic Level | V_{OH} | 0.725 | | | V | RL=50Ω |
| | V_{OL} | | | 0.1 | V | |
| Peak to Peak Output Swing (V_{pp}) | | | 750 | | mV | Single ended |
| Rise Time | T_r | 200 | | 400 | ps | RL=50Ω , CL=2pF 20% to 80% |
| Fall Time | T_f | 200 | | 400 | | |
| Duty Cycle | | 48 | | 52 | % | Differential |
| Integrated Phase Jitter (J_{PH}) | | | 0.25 | 2 | ps | 200kHz ~ 20MHz @156.25MHz |
| | | | 0.37 | 2 | | 100kHz ~ 20MHz @156.25MHz |
| | | | 1.70 | 2 | | 12kHz ~ 20MHz @156.25MHz |
| Period Jitter RMS (J_{PER}) | | | 2.5 | | ps | |

PERFORMANCE PLASTIC PACKAGE ULTRA MINIATURE PURE SILICON™ CLOCK OSCILLATOR

ASFLMP



Life Size



5.0 x 3.2 x 0.85 mm

ASFLMP



RoHS/RoHS II compliant

Absolute Maximum Ratings

| Item | Minimum | Maximum | Unit | Condition |
|-----------------|---------|----------------------|------|-----------|
| Supply Voltage | -0.3 | +4.0 | V | |
| Input Voltage | -0.3 | V _{dd} +0.3 | V | |
| Junction Temp. | | +150 | °C | |
| Storage Temp. | -55 | +150 | °C | |
| Soldering Temp. | | +260 | °C | 40sec max |
| ESD | | | V | |
| HBM | | 4,000 | | |
| MM | | 400 | | |
| CDM | | 1,500 | | |

OPTIONS AND PART IDENTIFICATION: (Left Blank if Standard)

Programmed Orders (Quantity > 1,000pcs)

ASFLMP [] - [] MHz - [] [] - [] - []

| Output Type | Frequency in MHz | Operating Temp. | Overall Freq. Stability | Tri-state (Pin 1) | Packaging |
|-------------|---|----------------------|-------------------------|-------------------|--------------------------------|
| C: CMOS | e.g. 156.2500 MHz (Maximum 4 digits after decimal) | Blank: -20°C ~ +70°C | Blank: ±50ppm | Blank: Tri-state | Blank***: Tube (72pcs / Tube) |
| LP: LVPECL | | L: -40°C ~ +85°C | Y: ±10ppm* | PD: Power Down | T: Tape & Reel (1kpcs / reel) |
| LV: LVDS | | X: -40°C ~ +105°C | R: ±25 ppm | | T3: Tape & Reel (3kpcs / reel) |
| HC: HCSL | | Z** : -55°C ~ +125°C | | | |

* Temp option L, X or -20°C ~ +70°C, only

** CMOS output only

*** For Quick turn-around programmable orders < 1000pcs: Due to the immediate availability of stock and the qty of the order, the parts may be delivered as BULK: Cut Tape, Loose parts in Antistatic Bag or in Tube(s). The MOQ per the series will still apply for Tube packaging.

Un-Programmed Orders

Blank un-programmed oscillators are available for quick turn engineering requirements. Please call ABRACON for more information.

ASFLMP [] - BLANK - [] [] - [] - []

| Output Type | Operating Temp. | Overall Freq. Stability | Tri-state (Pin 1) | Packaging |
|-------------|----------------------|-------------------------|-------------------|--------------------------------|
| C: CMOS | Blank: -20°C ~ +70°C | Blank: ±50ppm | Blank: Tri-state | Blank: Tube (72pcs / Tube) |
| LP: LVPECL | L: -40°C ~ +85°C | Y: ±10ppm* | PD: Power Down | T: Tape & Reel (1kpcs / reel) |
| LV: LVDS | X: -40°C ~ +105°C | R: ±25 ppm | | T3: Tape & Reel (3kpcs / reel) |
| HC: HCSL | Z** : -55°C ~ +125°C | | | |

* Temp option L, X or -20°C ~ +70°C, only

** CMOS output only

PERFORMANCE PLASTIC PACKAGE ULTRA MINIATURE PURE SILICON™ CLOCK OSCILLATOR

ASFLMP



Life Size



5.0 x 3.2 x 0.85 mm

ASFLMP



RoHS/RoHS II compliant

NOMINAL PERFORMANCE PARAMETERS

(Unless specified otherwise: T=25° C, VDD=3.3 V)

CMOS OUTPUT

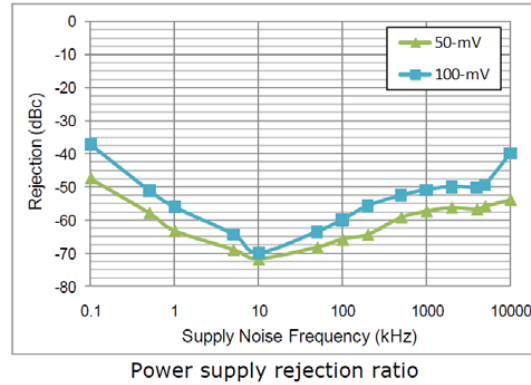
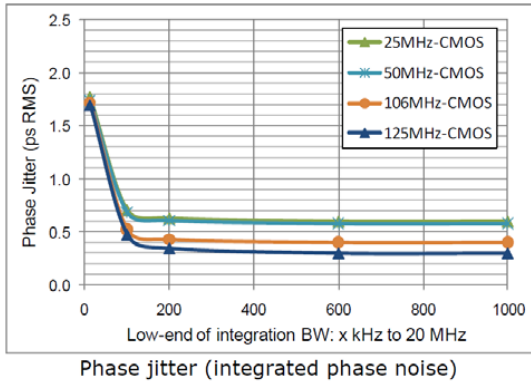

Test Circuit

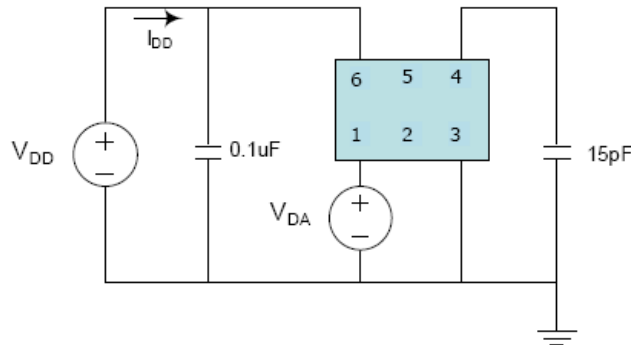

LVPECL output

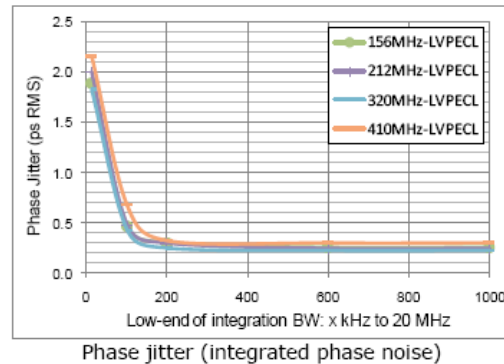
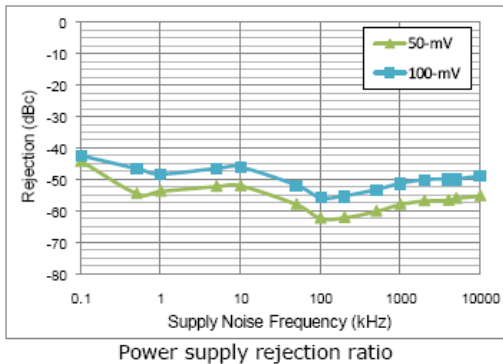

Test Circuit

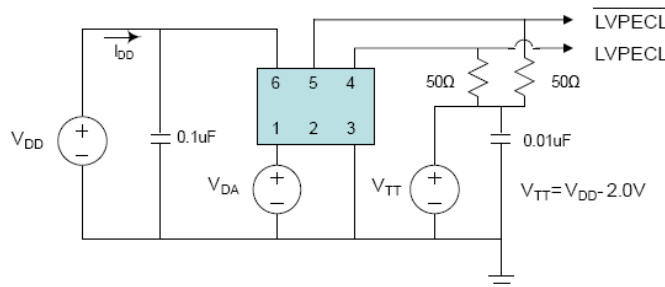

REVISED: 12.6.2017

PERFORMANCE PLASTIC PACKAGE ULTRA MINIATURE PURE SILICON™ CLOCK OSCILLATOR

ASFLMP



Life Size
5.0 x 3.2 x 0.85 mm

ASFLMP



RoHS/RoHS II compliant

LVDS output

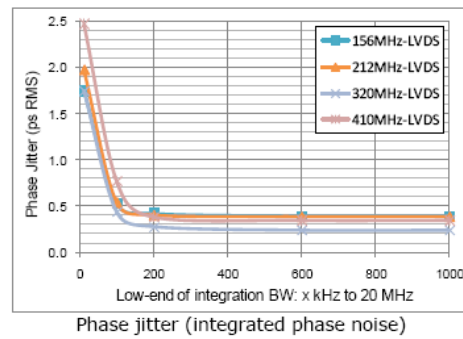
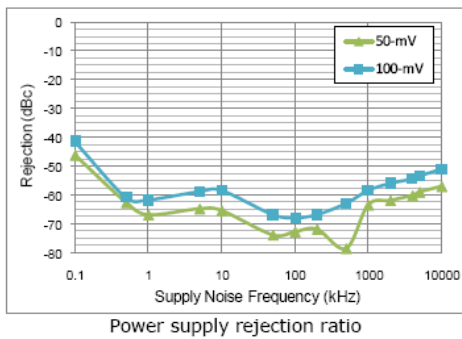

Test Circuit

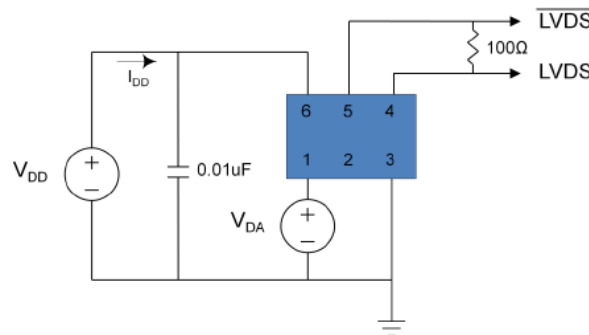

HCSL output

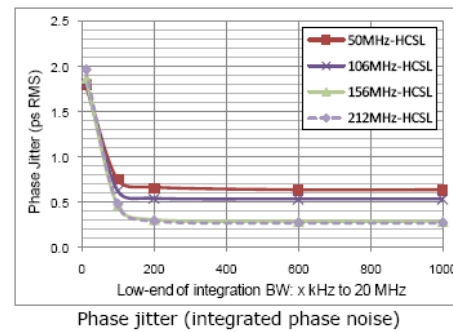
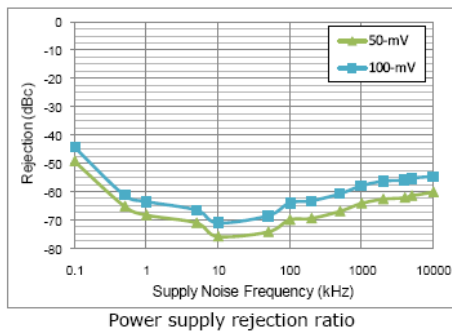

Test Circuit

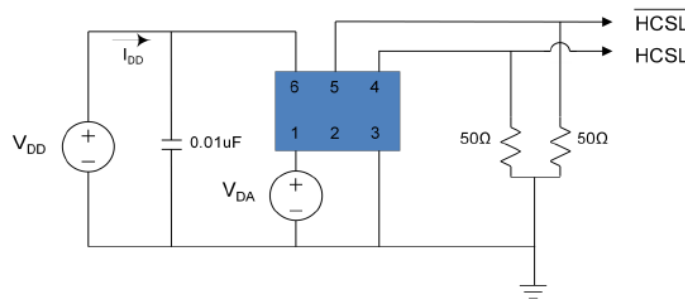

PERFORMANCE PLASTIC PACKAGE ULTRA MINIATURE PURE SILICON™ CLOCK OSCILLATOR

ASFLMP



Life Size 
5.0 x 3.2 x 0.85 mm

ASFLMP



RoHS/RoHS II compliant

OUTLINE DIMENSIONS:

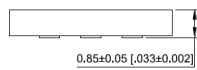
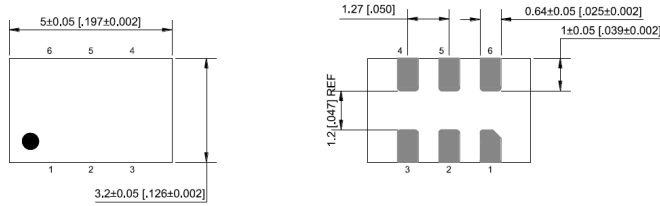

| Pin # | Function |
|-------|------------------------------------|
| 1 | Tri-state |
| 2 | NC |
| 3 | GND |
| 4 | Output |
| 5 | NC (CMOS) |
| 6 | Output (LVPECL, LVDS, HCSL) Vdd |

Note: Recommend using an approximately 0.01uF bypass capacitor between PIN 6 and 3.

Dimensions: mm (inches)

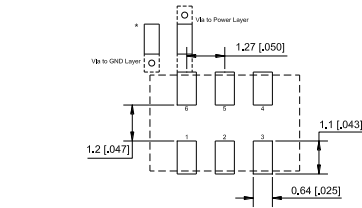
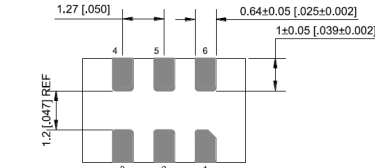

Recommended Land Pattern for LVPECL, LVDS, HCSL

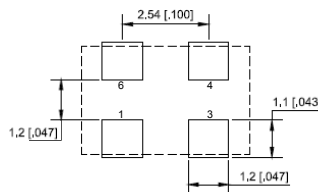

Recommended Land Pattern for CMOS

REFLOW PROFILE:

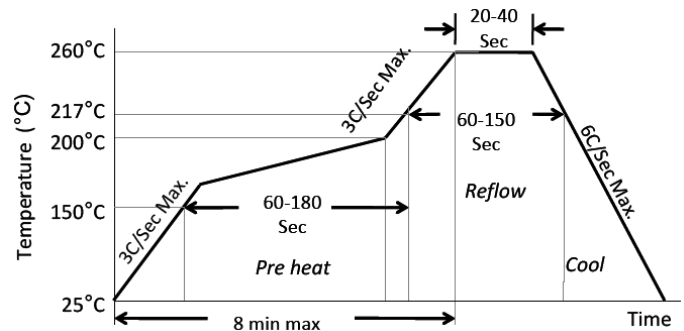

| | |
|-----------------------------------|--------------|
| Ramp-Up Rate (200°C to Peak Temp) | 3°C/Sec Max. |
| Preheat Time 150°C to 200°C | 60-180 Sec |
| Time maintained above 217°C | 60-150 Sec |
| Peak Temperature | 255-260°C |
| Time within 5°C of actual Peak | 20-40 Sec |
| Ramp-Down Rate | 6°C/Sec Max. |
| Time 25°C to Peak Temperature | 8 min Max. |

TAPE AND REEL:

T= 1,000pcs/reel (D=180mm), T3= 3,000pcs/reel (D=330mm)

Tape 1

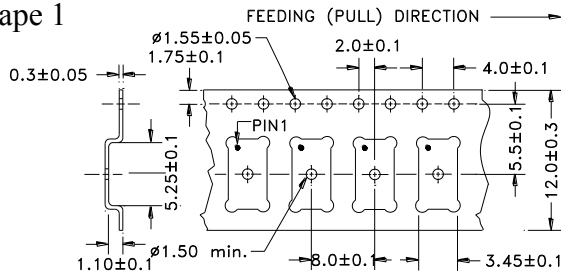

Tube: 72 pcs/tube

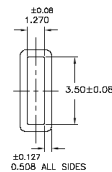

Unit orientation in tube:



Tape 2

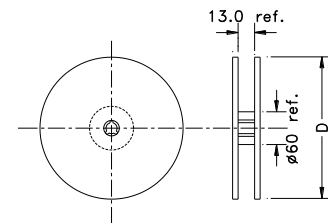
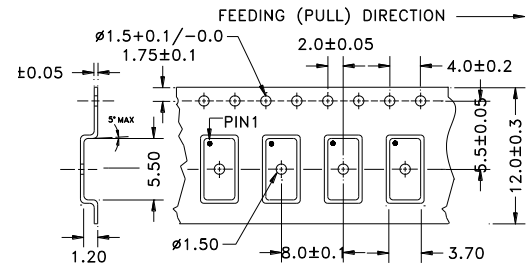

Dimensions: mm

ATTENTION: Abracon LLC products are COTS – Commercial-Off-The-Shelf products; suitable for Commercial, Industrial and, where designated, Automotive Applications. Abracon's products are not specifically designed for Military, Aviation, Aerospace, Life-dependant Medical applications or any application requiring high reliability where component failure could result in loss of life and/or property. For applications requiring high reliability and/or presenting an extreme operating environment, written consent and authorization from Abracon LLC is required. Please contact Abracon LLC for more information.

Mouser Electronics

Authorized Distributor

Click to View Pricing, Inventory, Delivery & Lifecycle Information:

ABRACON:

[ASFLMPC-10.000MHZ-LR-T](#) [ASFLMPC-10.000MHZ-LY-T3](#) [ASFLMPC-10.000MHZ-T3](#) [ASFLMPC-10.000MHZ-Z-T](#)
[ASFLMPC-100.000MHZ-LR-T](#) [ASFLMPC-100.000MHZ-LY-T3](#) [ASFLMPC-100.000MHZ-T3](#) [ASFLMPC-100.000MHZ-Z-T](#)
[ASFLMPC-106.250MHZ-LR-T](#) [ASFLMPC-106.250MHZ-LY-T3](#) [ASFLMPC-106.250MHZ-T3](#) [ASFLMPC-](#)
[106.250MHZ-Z-T](#) [ASFLMPC-11.0592MHZ-LR-T](#) [ASFLMPC-11.0592MHZ-LY-T3](#) [ASFLMPC-11.0592MHZ-T3](#)
[ASFLMPC-11.0592MHZ-Z-T](#) [ASFLMPC-12.000MHZ-LR-T](#) [ASFLMPC-12.000MHZ-LY-T3](#) [ASFLMPC-12.000MHZ-T3](#)
[ASFLMPC-12.000MHZ-Z-T](#) [ASFLMPC-12.288MHZ-LR-T](#) [ASFLMPC-12.288MHZ-LY-T3](#) [ASFLMPC-12.288MHZ-T3](#)
[ASFLMPC-12.288MHZ-Z-T](#) [ASFLMPC-12.352MHZ-LR-T](#) [ASFLMPC-12.352MHZ-LY-T3](#) [ASFLMPC-12.352MHZ-T3](#)
[ASFLMPC-12.352MHZ-Z-T](#) [ASFLMPC-12.500MHZ-LR-T](#) [ASFLMPC-12.500MHZ-T3](#) [ASFLMPC-12.500MHZ-Z-T](#)
[ASFLMPC-120.000MHZ-LR-T](#) [ASFLMPC-120.000MHZ-T3](#) [ASFLMPC-120.000MHZ-Z-T](#) [ASFLMPC-125.000MHZ-LR-T](#)
[ASFLMPC-125.000MHZ-LY-T3](#) [ASFLMPC-125.000MHZ-T3](#) [ASFLMPC-125.000MHZ-Z-T](#) [ASFLMPC-13.000MHZ-LR-](#)
[T](#) [ASFLMPC-13.000MHZ-T3](#) [ASFLMPC-13.000MHZ-Z-T](#) [ASFLMPC-133.333MHZ-LR-T](#) [ASFLMPC-133.333MHZ-LY-](#)
[T3](#) [ASFLMPC-133.333MHZ-T3](#) [ASFLMPC-133.333MHZ-Z-T](#) [ASFLMPC-14.31818MHZ-LR-T](#) [ASFLMPC-](#)
[14.31818MHZ-LY-T3](#) [ASFLMPC-14.31818MHZ-T3](#) [ASFLMPC-14.31818MHZ-Z-T](#) [ASFLMPC-14.7456MHZ-LR-T](#)
[ASFLMPC-14.7456MHZ-LY-T3](#) [ASFLMPC-14.7456MHZ-T3](#) [ASFLMPC-14.7456MHZ-Z-T](#) [ASFLMPC-15.000MHZ-LR-T](#)
[ASFLMPC-15.000MHZ-T3](#) [ASFLMPC-15.000MHZ-Z-T](#) [ASFLMPC-150.000MHZ-LR-T](#) [ASFLMPC-150.000MHZ-LY-T3](#)
[ASFLMPC-150.000MHZ-T3](#) [ASFLMPC-150.000MHZ-Z-T](#) [ASFLMPC-16.000MHZ-LR-T](#) [ASFLMPC-16.000MHZ-LY-T3](#)
[ASFLMPC-16.000MHZ-T3](#) [ASFLMPC-16.000MHZ-Z-T](#) [ASFLMPC-16.384MHZ-LR-T](#) [ASFLMPC-16.384MHZ-LY-T3](#)
[ASFLMPC-16.384MHZ-T3](#) [ASFLMPC-16.384MHZ-Z-T](#) [ASFLMPC-18.432MHZ-LR-T](#) [ASFLMPC-18.432MHZ-LY-T3](#)
[ASFLMPC-18.432MHZ-T3](#) [ASFLMPC-18.432MHZ-Z-T](#) [ASFLMPC-19.440MHZ-LR-T](#) [ASFLMPC-19.440MHZ-T3](#)
[ASFLMPC-19.440MHZ-Z-T](#) [ASFLMPC-20.000MHZ-LR-T](#) [ASFLMPC-20.000MHZ-LY-T3](#) [ASFLMPC-20.000MHZ-T3](#)
[ASFLMPC-20.000MHZ-Z-T](#) [ASFLMPC-24.000MHZ-LR-T](#) [ASFLMPC-24.000MHZ-LY-T3](#) [ASFLMPC-24.000MHZ-T3](#)
[ASFLMPC-24.000MHZ-Z-T](#) [ASFLMPC-24.576MHZ-LR-T](#) [ASFLMPC-24.576MHZ-LY-T3](#) [ASFLMPC-24.576MHZ-T3](#)
[ASFLMPC-24.576MHZ-Z-T](#) [ASFLMPC-25.000MHZ-LR-T](#) [ASFLMPC-25.000MHZ-LY-T3](#) [ASFLMPC-25.000MHZ-T3](#)
[ASFLMPC-25.000MHZ-Z-T](#) [ASFLMPC-26.000MHZ-LR-T](#) [ASFLMPC-26.000MHZ-T3](#) [ASFLMPC-26.000MHZ-Z-T](#)
[ASFLMPC-27.000MHZ-LR-T](#) [ASFLMPC-27.000MHZ-LY-T3](#) [ASFLMPC-27.000MHZ-T3](#) [ASFLMPC-27.000MHZ-Z-T](#)
[ASFLMPC-29.4912MHZ-LR-T](#) [ASFLMPC-29.4912MHZ-LY-T3](#)