

# Operational Amplifier, Rail-to-Rail, Low Input Bias Current, 1.8 V to 5 V Single-Supply



SC70-5  
SQ SUFFIX  
CASE 419A  
STYLES 3

## LMV301

The LMV301 CMOS operational amplifier can operate over a power supply range from 1.8 V to 5 V and has a quiescent current of less than 200  $\mu$ A, maximum, making it ideal for portable battery-operated applications such as notebook computers, PDA's and medical equipment. Low input bias current and high input impedance make it highly tolerant of high source-impedance signal-sources such as photodiodes and pH probes. In addition, the LMV301's excellent rail-to-rail performance will enhance the signal-to-noise performance of any application together with an output stage capable of easily driving a 600  $\Omega$  resistive load and up to 1000 pF capacitive load.

### Features

- Single Supply Operation (or  $\pm V_S/2$ )
- $V_S$  from 1.8 V to 5 V
- Low Quiescent Current: 185  $\mu$ A, Max with  $V_S = 1.8$  V
- Rail-to-Rail Output Swing
- Low Bias Current: 35 pA, max
- No Output Phase-Reversal when the Inputs are Overdriven
- These are Pb-Free Devices

### Typical Applications

- Portable Battery-Powered Instruments
- Notebook Computers and PDAs
- Cell Phones and Mobile Communication
- Digital Cameras
- Photodiode Amplifiers
- Transducer Amplifiers
- Medical Instrumentation
- Consumer Products

### MARKING DIAGRAM

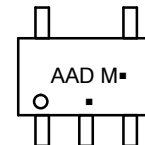

LMV301 = Specific Device Code  
M = Date Code  
▪ = Pb-Free Package

(Note: Microdot may be in either location)

\*Date Code orientation and/or position may vary depending upon manufacturing location.

### PIN CONNECTION

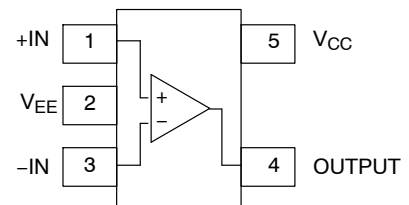

STYLE 3 PINOUT

### ORDERING INFORMATION

See detailed ordering and shipping information in the dimensions section on page 11 of this data sheet.

# LMV301

## MAXIMUM RATINGS

Symbol	Rating	Value	Unit
$V_S$	Power Supply (Operating Voltage Range $V_S = 1.8\text{ V to }5.0\text{ V}$ )	5.5	V
$V_{IDR}$	Input Differential Voltage	$\pm$ Supply Voltage	V
$V_{ICR}$	Input Common Mode Voltage Range	$-0.5\text{ to }(V+) + 0.5$	V
	Maximum Input Current	10	mA
$t_{So}$	Output Short Circuit (Note 1)	Continuous	
$T_J$	Maximum Junction Temperature (Operating Range $-40^\circ\text{C to }85^\circ\text{C}$ )	150	$^\circ\text{C}$
$J_A$	Thermal Resistance (5-Pin SC70-5)	280	$^\circ\text{C/W}$
$T_{stg}$	Storage Temperature	$-65\text{ to }150$	$^\circ\text{C}$
	Mounting Temperature (Infrared or Convection (30 sec))	260	
$V_{ESD}$	ESD Tolerance	100 1500	V
	Machine Model		
	Human Body Model		

Stresses exceeding those listed in the Maximum Ratings table may damage the device. If any of these limits are exceeded, device functionality should not be assumed, damage may occur and reliability may be affected.

1. Continuous short-circuit to ground operation at elevated ambient temperature can result in exceeding the maximum allowed junction temperature of  $150^\circ\text{C}$ . Output currents in excess of 45 mA over long term may adversely affect reliability. Also, shorting output to  $V+$  will adversely affect reliability; likewise shorting output to  $V-$  will adversely affect reliability.

# LMV301

**1.8 V DC ELECTRICAL CHARACTERISTICS** (Unless otherwise specified, all limits are guaranteed for  $T_A = 25^\circ\text{C}$ ,  $V_{CC} = 1.8\text{ V}$ ,  $R_L = 1\text{ M}\Omega$ ,  $V_{EE} = 0\text{ V}$ ,  $V_O = V_{CC}/2$ )

Parameter	Symbol	Condition	Min	Typ	Max	Unit
Input Offset Voltage	$V_{IO}$	$T_A = -40^\circ\text{C to } +85^\circ\text{C}$		1.7	9	mV
Input Offset Voltage Average Drift	$T_C V_{IO}$	$T_A = -40^\circ\text{C to } +85^\circ\text{C}$		5		$\mu\text{V}/^\circ\text{C}$
Input Bias Current (Note 2)	$I_B$			3	35	pA
		$T_A = -40^\circ\text{C to } +85^\circ\text{C}$			50	
Common Mode Rejection Ratio	CMRR	$0\text{ V} \leq V_{CM} \leq 0.9\text{ V}$	50	63		dB
Power Supply Rejection Ratio	PSRR	$1.8\text{ V} \leq V_{CC} \leq 5\text{ V}$ , $V_O = 1\text{ V}$ , $V_{CM} = 1\text{ V}$	62	100		dB
Input Common-Mode Voltage Range	$V_{CM}$	For CMRR $\geq 50\text{ dB}$	0 to 0.9	-0.2 to 0.9		V
Large Signal Voltage Gain (Note 2)	$A_V$	$R_L = 600\Omega$	83	100		dB
		$T_A = -40^\circ\text{C to } +85^\circ\text{C}$	80			
		$R_L = 2\text{ k}\Omega$	83	100		
		$T_A = -40^\circ\text{C to } +85^\circ\text{C}$	80			
Output Swing	$V_{OH}$	$R_L = 600\Omega\text{ to } 0.9\text{ V}$ $T_A = -40^\circ\text{C to } +85^\circ\text{C}$	1.65 1.63			V
	$V_{OL}$	$R_L = 600\Omega\text{ to } 0.9\text{ V}$ $T_A = -40^\circ\text{C to } +85^\circ\text{C}$		75	100 120	mV
	$V_{OH}$	$R_L = 2\text{ k}\Omega\text{ to } 0.9\text{ V}$ $T_A = -40^\circ\text{C to } +85^\circ\text{C}$	1.5 1.4	1.76		V
	$V_{OL}$	$R_L = 2\text{ k}\Omega\text{ to } 0.9\text{ V}$ $T_A = -40^\circ\text{C to } +85^\circ\text{C}$		25	35 40	mV
Output Short Circuit Current (Note 2)	$I_O$	Sourcing = $V_O = 0\text{ V}$ Sinking = $V_O = 1.8\text{ V}$	10 20	60 160		mA
Supply Current	$I_{CC}$	$T_A = -40^\circ\text{C to } +85^\circ\text{C}$			185	$\mu\text{A}$

**1.8 V AC ELECTRICAL CHARACTERISTICS** (Unless otherwise specified, all limits are guaranteed for  $T_A = 25^\circ\text{C}$ ,  $V_{CC} = 1.8\text{ V}$ ,  $R_L = 1\text{ M}\Omega$ ,  $V_{EE} = 0\text{ V}$ ,  $V_O = V_{CC}/2$ )

Parameter	Symbol	Condition	Min	Typ	Max	Unit
Slew Rate	$S_R$			1		$\text{V}/\mu\text{s}$
Gain Bandwidth Product	GBWP	$C_L = 200\text{ pF}$		1		MHz
Phase Margin	$\Theta_m$			60		$^\circ$
Gain Margin	$G_m$			10		dB
Input-Referred Voltage Noise	$e_n$	$f = 50\text{ kHz}$		50		$\text{nV}/\sqrt{\text{Hz}}$
Total Harmonic Distortion	THD	$A_V = +1$ , $V = 1\text{ V}_{PP}$ , $R_L = 10\text{ kW}$ , $f = 1\text{ kHz}$		0.01		%

2. Guaranteed by design and/or characterization.

# LMV301

**2.7 V DC ELECTRICAL CHARACTERISTICS** (Unless otherwise specified, all limits are guaranteed for  $T_A = 25^\circ\text{C}$ ,  $V_{CC} = 2.7\text{ V}$ ,  $R_L = 1\text{ M}\Omega$ ,  $V_{EE} = 0\text{ V}$ ,  $V_O = V_{CC}/2$ )

Parameter	Symbol	Condition	Min	Typ	Max	Unit
Input Offset Voltage	$V_{IO}$	$T_A = -40^\circ\text{C to } +85^\circ\text{C}$		1.7	9	mV
Input Offset Voltage Average Drift	$T_C V_{IO}$	$T_A = -40^\circ\text{C to } +85^\circ\text{C}$		5		$\mu\text{V}/^\circ\text{C}$
Input Bias Current (Note 2)	$I_B$			3	35	pA
		$T_A = -40^\circ\text{C to } +85^\circ\text{C}$			50	
Common Mode Rejection Ratio	CMRR	$0\text{ V} \leq V_{CM} \leq 1.35\text{ V}$	50	63		dB
Power Supply Rejection Ratio	PSRR	$1.8\text{ V} \leq V_{CC} \leq 5\text{ V}$ , $V_O = 1\text{ V}$ , $V_{CM} = 1\text{ V}$	62	100		dB
Input Common-Mode Voltage Range	$V_{CM}$	For CMRR $\geq 50\text{ dB}$	0 to 1.35	-0.2 to 1.35		V
Large Signal Voltage Gain (Note 2)	$A_V$	$R_L = 600\ \Omega$	83	100		dB
		$T_A = -40^\circ\text{C to } +85^\circ\text{C}$	80			
		$R_L = 2\text{ k}\Omega$	83	100		
		$T_A = -40^\circ\text{C to } +85^\circ\text{C}$	80			
Output Swing	$V_{OH}$	$R_L = 600\ \Omega \text{ to } 1.35\text{ V}$ $T_A = -40^\circ\text{C to } +85^\circ\text{C}$	2.55 2.53	2.62		V
	$V_{OL}$	$R_L = 600\ \Omega \text{ to } 1.35\text{ V}$ $T_A = -40^\circ\text{C to } +85^\circ\text{C}$		78	100 280	mV
	$V_{OH}$	$R_L = 2\text{ k}\Omega \text{ to } 1.35\text{ V}$ $T_A = -40^\circ\text{C to } +85^\circ\text{C}$	2.65 2.64	2.675		V
	$V_{OL}$	$R_L = 2\text{ k}\Omega \text{ to } 1.35\text{ V}$ $T_A = -40^\circ\text{C to } +85^\circ\text{C}$		75	100 110	mV
Output Short Circuit Current (Note 2)	$I_O$	Sourcing = $V_O = 0\text{ V}$ Sinking = $V_O = 2.7\text{ V}$	10 20	60 160		mA
Supply Current	$I_{CC}$	$T_A = -40^\circ\text{C to } +85^\circ\text{C}$			185	$\mu\text{A}$

**2.7 V AC ELECTRICAL CHARACTERISTICS** (Unless otherwise specified, all limits are guaranteed for  $T_A = 25^\circ\text{C}$ ,  $V_{CC} = 2.7\text{ V}$ ,  $R_L = 1\text{ M}\Omega$ ,  $V_{EE} = 0\text{ V}$ ,  $V_O = V_{CC}/2$ )

Parameter	Symbol	Condition	Min	Typ	Max	Unit
Slew Rate	$S_R$			1		$\text{V}/\mu\text{s}$
Gain Bandwidth Product	GBWP	$C_L = 200\text{ pF}$		1		MHz
Phase Margin	$\Theta_m$			60		$^\circ$
Gain Margin	$G_m$			10		dB
Input-Referred Voltage Noise	$e_n$	$f = 50\text{ kHz}$		50		$\text{nV}/\sqrt{\text{Hz}}$
Total Harmonic Distortion	THD	$A_V = +1$ , $V = 1\text{ V}_{PP}$ , $R_L = 10\text{ kW}$ , $f = 1\text{ kHz}$		0.01		%

2. Guaranteed by design and/or characterization.

# LMV301

**5.0 V DC ELECTRICAL CHARACTERISTICS** (Unless otherwise specified, all limits are guaranteed for  $T_A = 25^\circ\text{C}$ ,  $V_{CC} = 5.0\text{ V}$ ,  $R_L = 1\text{ M}\Omega$ ,  $V_{EE} = 0\text{ V}$ ,  $V_O = V_{CC}/2$ )

Parameter	Symbol	Condition	Min	Typ	Max	Unit
Input Offset Voltage	$V_{IO}$	$T_A = -40^\circ\text{C to } +85^\circ\text{C}$		1.7	9	mV
Input Offset Voltage Average Drift	$T_C V_{IO}$	$T_A = -40^\circ\text{C to } +85^\circ\text{C}$		5		$\mu\text{V}/^\circ\text{C}$
Input Bias Current (Note 2)	$I_B$			3	35	pA
		$T_A = -40^\circ\text{C to } +85^\circ\text{C}$			50	
Common Mode Rejection Ratio	CMRR	$0\text{ V} \leq V_{CM} \leq 4\text{ V}$	50	63		dB
Power Supply Rejection Ratio	PSRR	$1.8\text{ V} \leq V_{CC} \leq 5\text{ V}$ , $V_O = 1\text{ V}$ , $V_{CM} = 1\text{ V}$	62	100		dB
Input Common-Mode Voltage Range	$V_{CM}$	For CMRR $\geq 50\text{ dB}$	0 to 4	-0.2 to 4.2		V
Large Signal Voltage Gain (Note 2)	$A_V$	$R_L = 600\ \Omega$	83	100		dB
		$T_A = -40^\circ\text{C to } +85^\circ\text{C}$	80			
		$R_L = 2\text{ k}\Omega$	83	100		
		$T_A = -40^\circ\text{C to } +85^\circ\text{C}$	80			
Output Swing	$V_{OH}$	$R_L = 600\ \Omega$ to $2.5\text{ V}$ $T_A = -40^\circ\text{C to } +85^\circ\text{C}$	4.850 4.840			V
	$V_{OL}$	$R_L = 600\ \Omega$ to $2.5\text{ V}$ $T_A = -40^\circ\text{C to } +85^\circ\text{C}$			150 160	mV
	$V_{OH}$	$R_L = 2\text{ k}\Omega$ to $2.5\text{ V}$ $T_A = -40^\circ\text{C to } +85^\circ\text{C}$	4.935 4.900			V
	$V_{OL}$	$R_L = 2\text{ k}\Omega$ to $2.5\text{ V}$ $T_A = -40^\circ\text{C to } +85^\circ\text{C}$			65 75	mV
Output Short Circuit Current (Note 2)	$I_O$	Sourcing = $V_O = 0\text{ V}$ Sinking = $V_O = 5\text{ V}$	10 10	60 160		mA
Supply Current	$I_{CC}$	$T_A = -40^\circ\text{C to } +85^\circ\text{C}$			200	$\mu\text{A}$

**5.0 V AC ELECTRICAL CHARACTERISTICS** (Unless otherwise specified, all limits are guaranteed for  $T_A = 25^\circ\text{C}$ ,  $V_{CC} = 5.0\text{ V}$ ,  $R_L = 1\text{ M}\Omega$ ,  $V_{EE} = 0\text{ V}$ ,  $V_O = V_{CC}/2$ )

Parameter	Symbol	Condition	Min	Typ	Max	Unit
Slew Rate	$S_R$			1		$\text{V}/\mu\text{s}$
Gain Bandwidth Product	GBWP	$C_L = 200\text{ pF}$		1		MHz
Phase Margin	$\Theta_m$			60		$^\circ$
Gain Margin	$G_m$			10		dB
Input-Referred Voltage Noise	$e_n$	$f = 50\text{ kHz}$		50		$\text{nV}/\sqrt{\text{Hz}}$
Total Harmonic Distortion	THD	$A_V = +1$ , $V - 1\text{ V}_{PP}$ , $R_L = 10\text{ kW}$ , $f = 1\text{ kHz}$		0.01		%

2. Guaranteed by design and/or characterization.

# LMV301

## TYPICAL CHARACTERISTICS

( $T_A = 25^\circ\text{C}$  and  $V_S = 5\text{ V}$  unless otherwise specified)

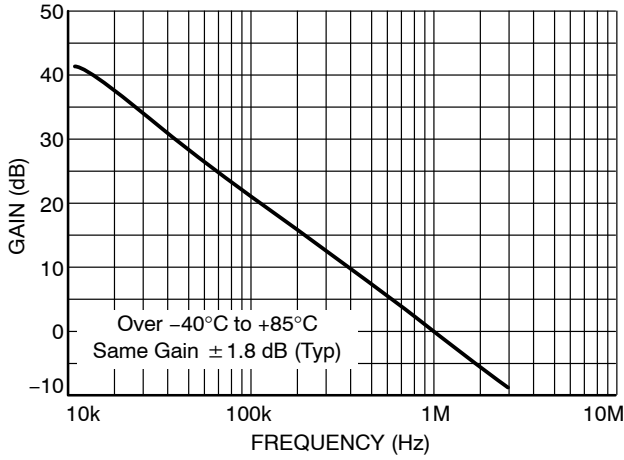

**Figure 1. Open Loop Frequency Response**  
( $R_L = 2\text{ k}\Omega$ ,  $T_A = 25^\circ\text{C}$ ,  $V_S = 5\text{ V}$ )

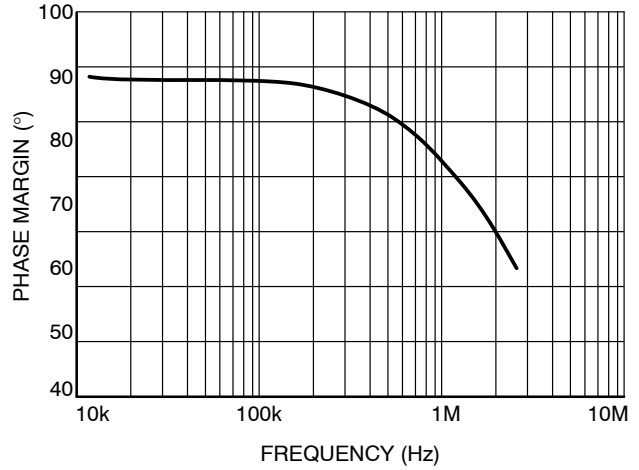

**Figure 2. Open Loop Phase Margin**  
( $R_L = 2\text{ k}\Omega$ ,  $T_A = 25^\circ\text{C}$ )

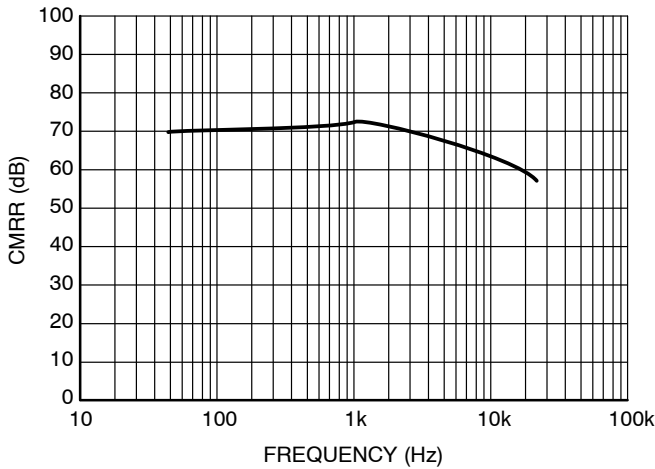

**Figure 3. CMRR vs. Frequency**  
( $R_L = 5\text{ k}\Omega$ ,  $V_S = 5\text{ V}$ )

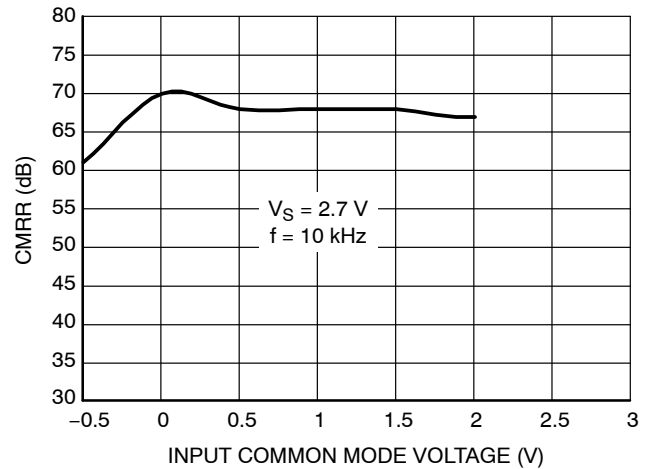

**Figure 4. CMRR vs. Input Common Mode Voltage**

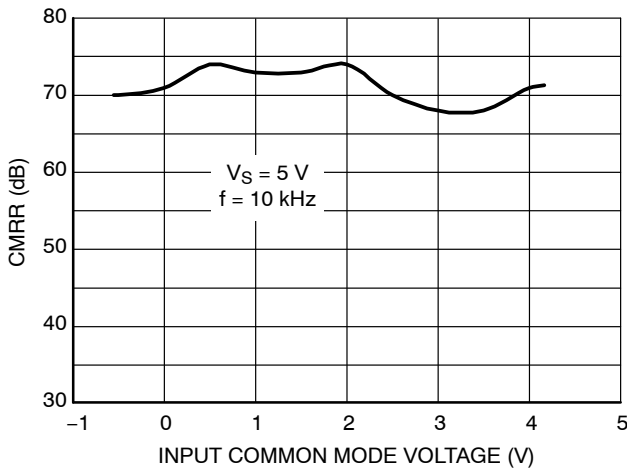

**Figure 5. CMRR vs. Input Common Mode Voltage**

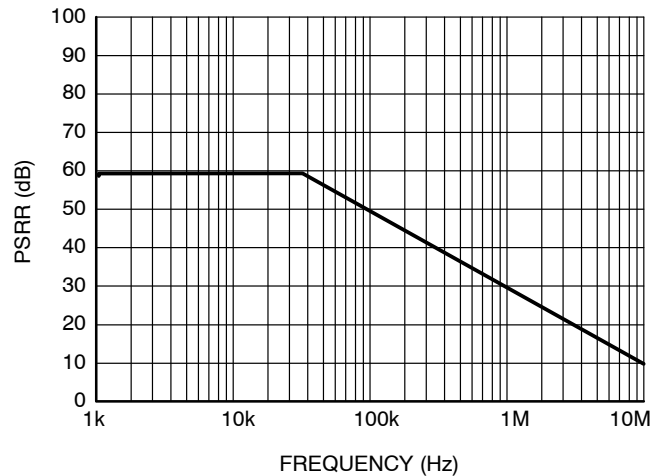
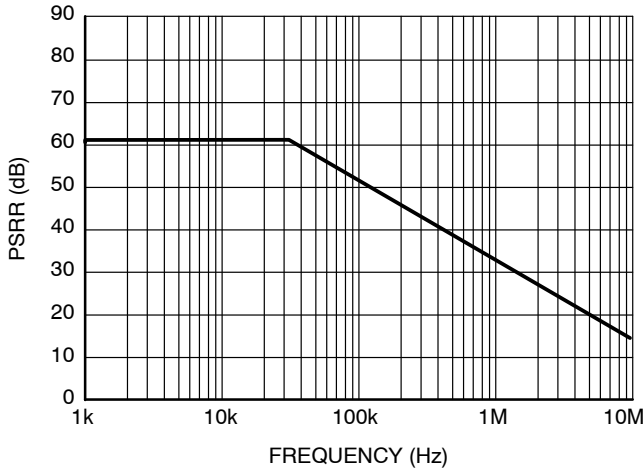

**Figure 6. PSRR vs. Frequency**  
( $R_L = 5\text{ k}\Omega$ ,  $V_S = 2.7\text{ V}$ , +PSRR)

# LMV301

## TYPICAL CHARACTERISTICS

( $T_A = 25^\circ\text{C}$  and  $V_S = 5\text{ V}$  unless otherwise specified)



**Figure 7. PSRR vs. Frequency**  
( $R_L = 5\text{ k}\Omega$ ,  $V_S = 2.7\text{ V}$ ,  $-\text{PSRR}$ )

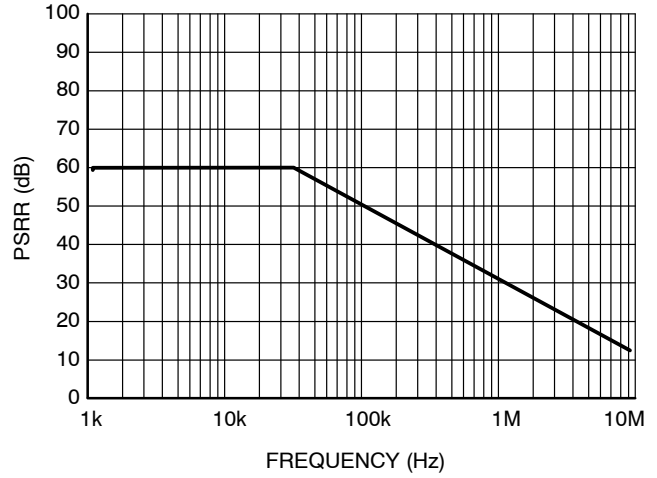

**Figure 8. PSRR vs. Frequency**  
( $R_L = 5\text{ k}\Omega$ ,  $V_S = 5\text{ V}$ ,  $+\text{PSRR}$ )

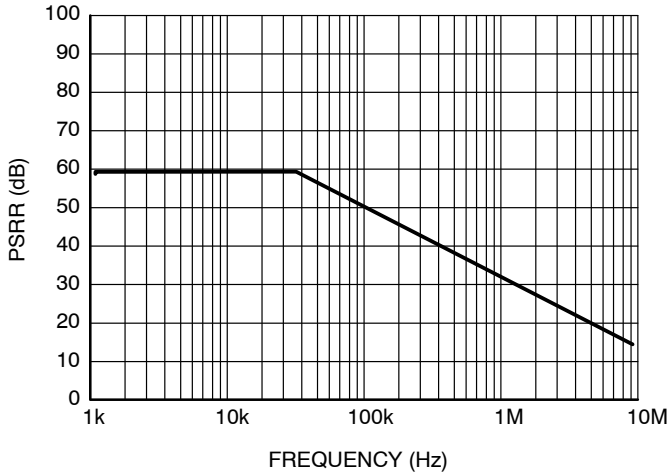

**Figure 9. PSRR vs. Frequency**  
( $R_L = 5\text{ k}\Omega$ ,  $V_S = 5\text{ V}$ ,  $-\text{PSRR}$ )

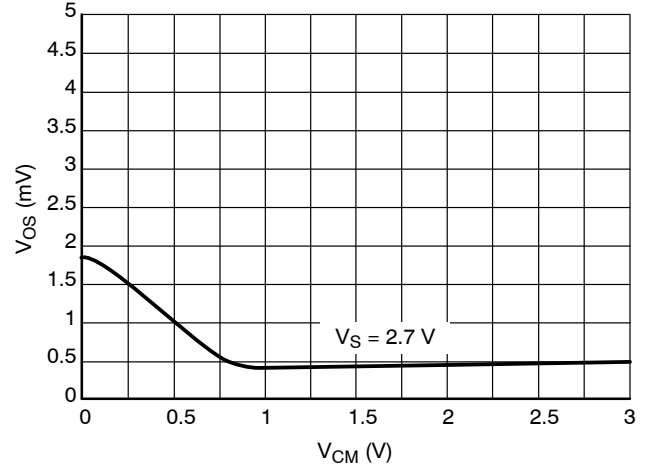

**Figure 10.  $V_{OS}$  vs. CMR**

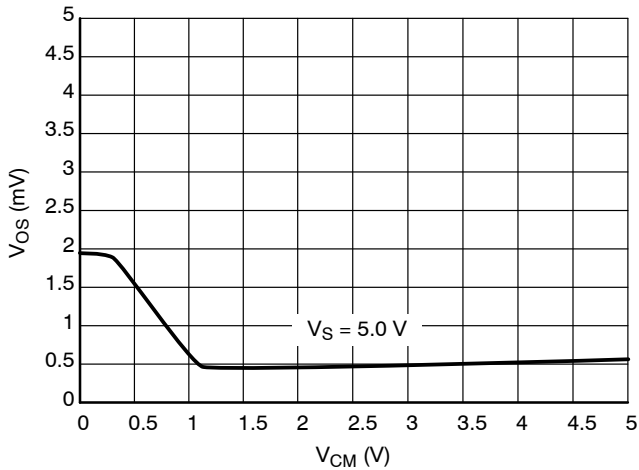

**Figure 11.  $V_{OS}$  vs. CMR**

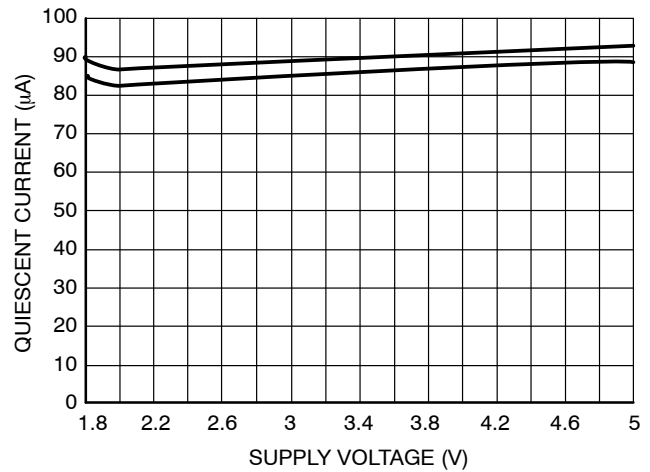

**Figure 12. Supply Current vs. Supply Voltage**

# LMV301

## TYPICAL CHARACTERISTICS

( $T_A = 25^\circ\text{C}$  and  $V_S = 5\text{ V}$  unless otherwise specified)



Figure 13. THD+N vs Frequency

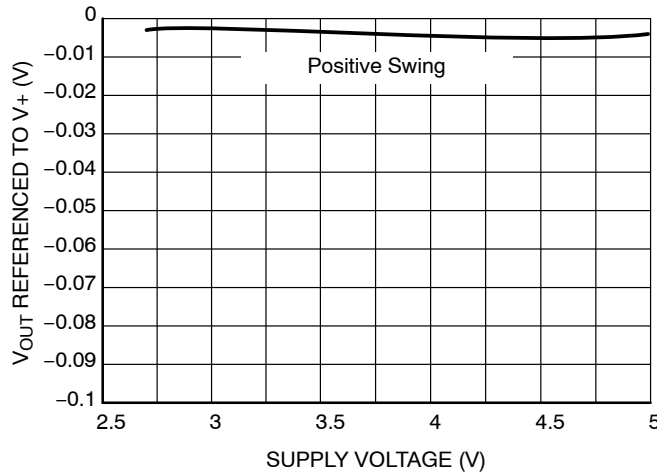

Figure 14. Output Voltage Swing vs Supply Voltage ( $R_L = 10\text{ k}$ )

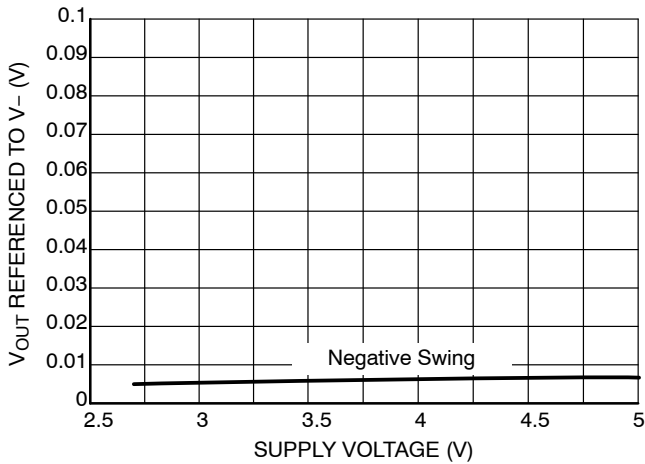

Figure 15. Output Voltage Swing vs Supply Voltage ( $R_L = 10\text{ k}$ )

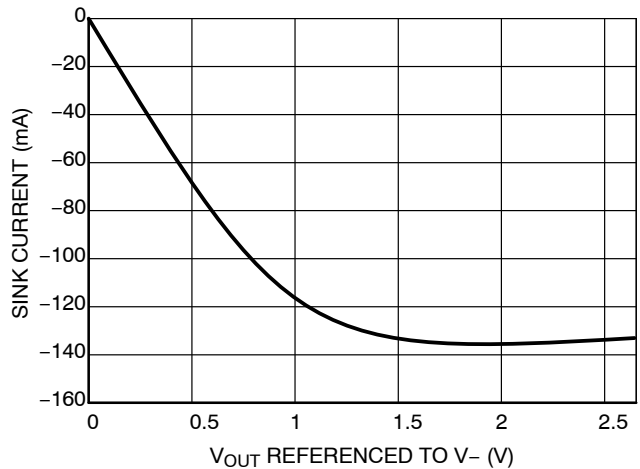

Figure 16. Sink Current vs. Output Voltage  
 $V_S = 2.7\text{ V}$

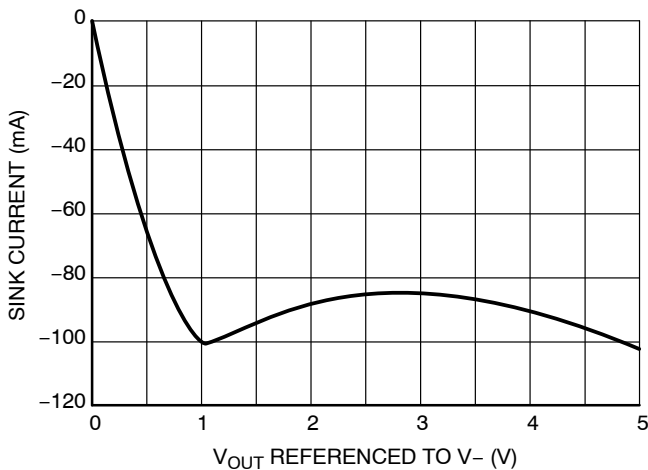

Figure 17. Sink Current vs. Output Voltage  
 $V_S = 5.0\text{ V}$

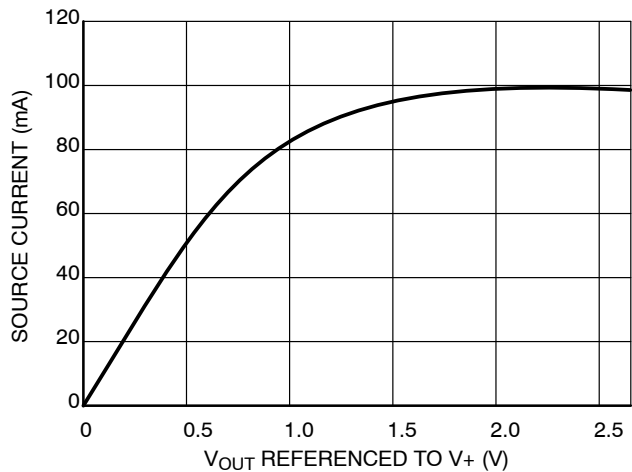

Figure 18. Source Current vs. Output Voltage  
 $V_S = 2.7\text{ V}$



# LMV301

## TYPICAL CHARACTERISTICS

( $T_A = 25^\circ\text{C}$  and  $V_S = 5\text{ V}$  unless otherwise specified)

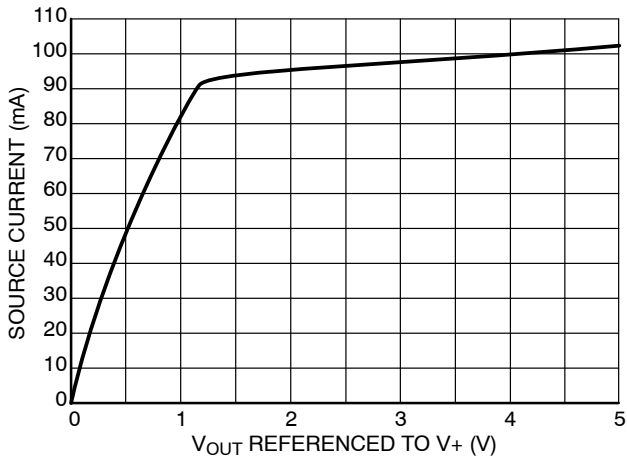

**Figure 19. Source Current vs. Output Voltage**  
 $V_S = 5.0\text{ V}$

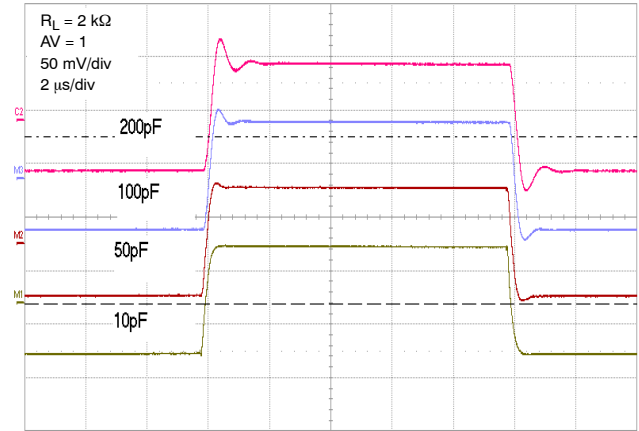

**Figure 20. Settling Time vs. Capacitive Load**

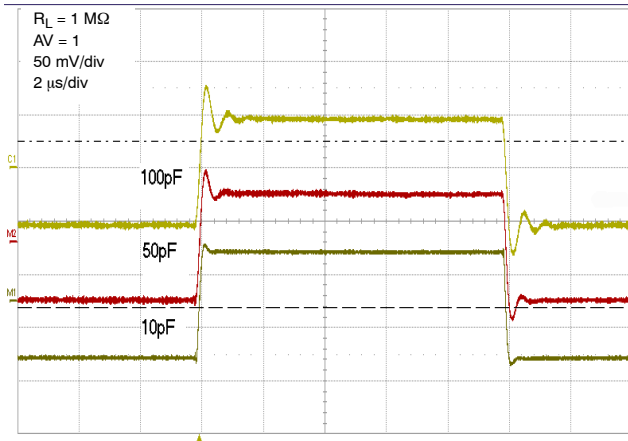

**Figure 21. Settling Time vs. Capacitive Load**

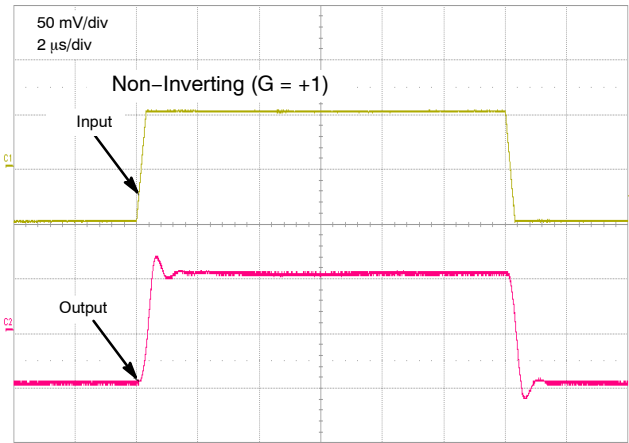

**Figure 22. Step Response - Small Signal**

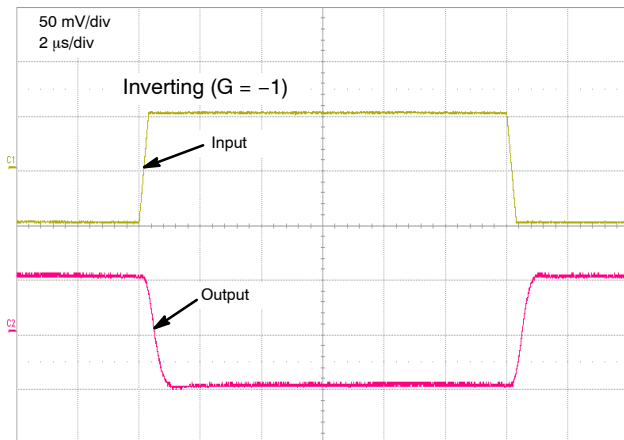

**Figure 23. Step Response - Small Signal**

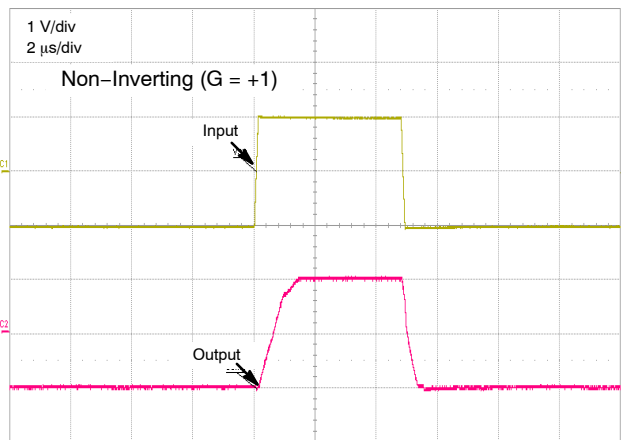

**Figure 24. Step Response - Large Signal**

# LMV301

## TYPICAL CHARACTERISTICS

( $T_A = 25^\circ\text{C}$  and  $V_S = 5\text{ V}$  unless otherwise specified)



**Figure 25. Step Response – Large Signal**

# LMV301

## APPLICATIONS

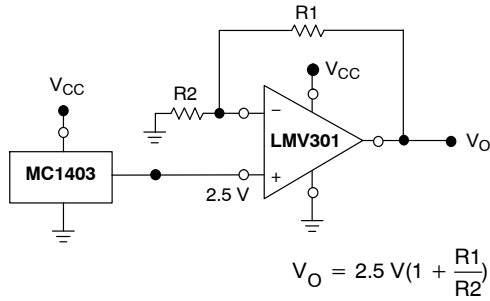

Figure 26. Voltage Reference

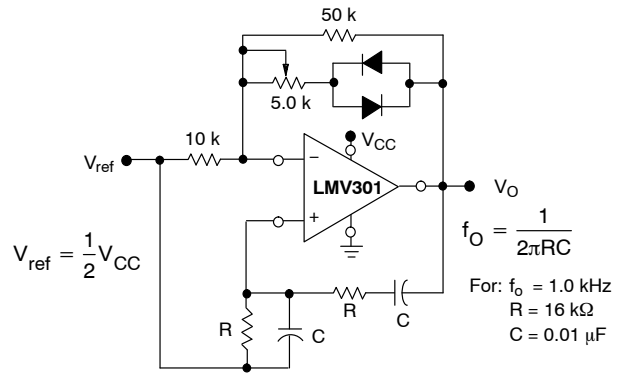

Figure 27. Wien Bridge Oscillator

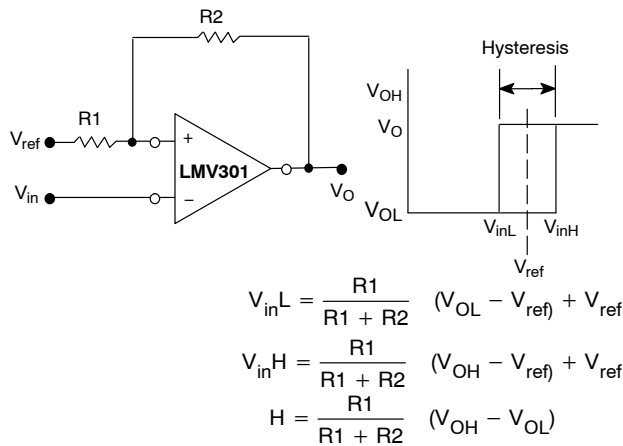
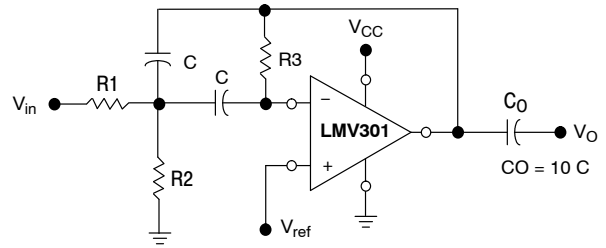

Figure 28. Comparator with Hysteresis



Given:  $f_o$  = center frequency  
 $A(f_o)$  = gain at center frequency

Choose value  $f_o, C$

$$\text{Then: } R_3 = \frac{Q}{\pi f_o C}$$

$$R_1 = \frac{R_3}{2 A(f_o)}$$

$$R_2 = \frac{R_1 R_3}{4Q^2 R_1 - R_3}$$

For less than 10% error from operational amplifier,  
 $((Q_o f_o)/BW) < 0.1$  where  $f_o$  and  $BW$  are expressed in Hz.  
 If source impedance varies, filter may be preceded with  
 voltage follower buffer to stabilize filter parameters.

Figure 29. Multiple Feedback Bandpass Filter

### ORDERING INFORMATION

Device	Pinout Style	Marking	Package	Shipping†
LMV301SQ3T2G	Style 3	AAD	SC70-5 (Pb-Free)	3000 / Tape & Reel

†For information on tape and reel specifications, including part orientation and tape sizes, please refer to our Tape and Reel Packaging Specifications Brochure, BRD8011/D.

# MECHANICAL CASE OUTLINE PACKAGE DIMENSIONS



SCALE 2:1

## SC-88A (SC-70-5/SOT-353) CASE 419A-02 ISSUE M

DATE 11 APR 2023

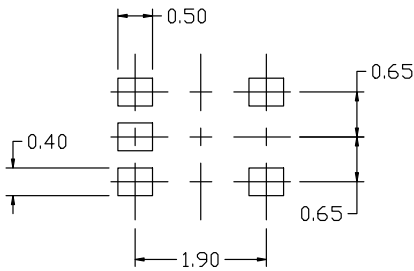
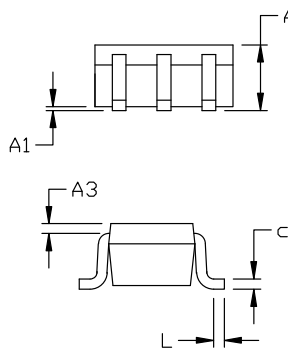
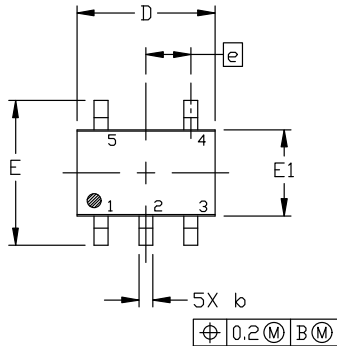

### RECOMMENDED MOUNTING FOOTPRINT

\* For additional information on our Pb-Free strategy and soldering details, please download the ON Semiconductor Soldering and Mounting Techniques Reference Manual, SOLDERM/D.

### NOTES:

1. DIMENSIONING AND TOLERANCING PER ANSI Y14.5M, 1982.
2. CONTROLLING DIMENSION: MILLIMETERS
3. 419A-01 OBSOLETE. NEW STANDARD 419A-02
4. DIMENSIONS D AND E1 DO NOT INCLUDE MOLD FLASH, PROTRUSIONS, OR GATE BURRS. MOLD FLASH, PROTRUSIONS, OR GATE BURRS SHALL NOT EXCEED 0.1016MM PER SIDE.

DIM	MILLIMETERS		
	MIN.	NOM.	MAX.
A	0.80	0.95	1.10
A1	---	---	0.10
A3	0.20 REF		
b	0.10	0.20	0.30
c	0.10	---	0.25
D	1.80	2.00	2.20
E	2.00	2.10	2.20
E1	1.15	1.25	1.35
e	0.65 BSC		
L	0.10	0.15	0.30

### GENERIC MARKING DIAGRAM\*

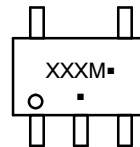

\*This information is generic. Please refer to device data sheet for actual part marking. Pb-Free indicator, "G" or microdot "▪", may or may not be present. Some products may not follow the Generic Marking.

XXX = Specific Device Code

M = Date Code

▪ = Pb-Free Package

(Note: Microdot may be in either location)

#### STYLE 1:

1. BASE
2. EMITTER
3. BASE
4. COLLECTOR
5. COLLECTOR

#### STYLE 2:

1. ANODE
2. EMITTER
3. BASE
4. COLLECTOR
5. CATHODE

#### STYLE 3:

1. ANODE 1
2. N/C
3. ANODE 2
4. CATHODE 2
5. CATHODE 1

#### STYLE 4:

1. SOURCE 1
2. DRAIN 1/2
3. SOURCE 1
4. GATE 1
5. GATE 2

#### STYLE 5:

1. CATHODE
2. COMMON ANODE
3. CATHODE 2
4. CATHODE 3
5. CATHODE 4

#### STYLE 6:

1. EMITTER 2
2. BASE 2
3. EMITTER 1
4. COLLECTOR
5. COLLECTOR 2/BASE 1

#### STYLE 7:

1. BASE
2. EMITTER
3. BASE
4. COLLECTOR
5. COLLECTOR

#### STYLE 8:

1. CATHODE
2. COLLECTOR
3. N/C
4. BASE
5. EMITTER

#### STYLE 9:

1. ANODE
2. CATHODE
3. ANODE
4. ANODE
5. ANODE

Note: Please refer to datasheet for style callout. If style type is not called out in the datasheet refer to the device datasheet pinout or pin assignment.

<b>DOCUMENT NUMBER:</b>	<b>98ASB42984B</b>	Electronic versions are uncontrolled except when accessed directly from the Document Repository. Printed versions are uncontrolled except when stamped "CONTROLLED COPY" in red.
<b>DESCRIPTION:</b>	<b>SC-88A (SC-70-5/SOT-353)</b>	<b>PAGE 1 OF 1</b>

onsemi and ONSEMI are trademarks of Semiconductor Components Industries, LLC dba onsemi or its subsidiaries in the United States and/or other countries. onsemi reserves the right to make changes without further notice to any products herein. onsemi makes no warranty, representation or guarantee regarding the suitability of its products for any particular purpose, nor does onsemi assume any liability arising out of the application or use of any product or circuit, and specifically disclaims any and all liability, including without limitation special, consequential or incidental damages. onsemi does not convey any license under its patent rights nor the rights of others.

# MECHANICAL CASE OUTLINE PACKAGE DIMENSIONS



## TSOP-5 3.00x1.50x0.95, 0.95P CASE 483 ISSUE P

DATE 01 APR 2024

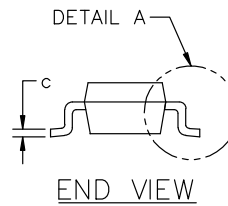
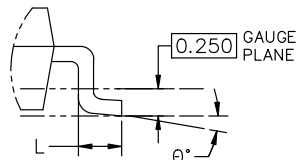

NOTES:

1. DIMENSIONING AND TOLERANCING CONFORM TO ASME Y14.5-2018.
2. ALL DIMENSION ARE IN MILLIMETERS (ANGLES IN DEGREES).
3. MAXIMUM LEAD THICKNESS INCLUDES LEAD FINISH THICKNESS. MINIMUM LEAD THICKNESS IS THE MINIMUM THICKNESS OF BASE MATERIAL.
4. DIMENSIONS D AND E1 DO NOT INCLUDE MOLD FLASH, PROTRUSIONS OF GATE BURRS. MOLD FLASH, PROTRUSIONS, OR GATE BURRS SHALL NOT EXCEED 0.15 PER SIDE. DIMENSION D.
5. OPTIONAL CONSTRUCTION: AN ADDITIONAL TRIMMED LEAD IS ALLOWED IN THIS LOCATION. TRIMMED LEAD NOT TO EXTEND MORE THAN 0.2 FROM BODY.

DIM	MILLIMETERS		
	MIN.	NOM.	MAX.
A	0.900	1.000	1.100
A1	0.010	0.055	0.100
A2	0.950 REF.		
b	0.250	0.375	0.500
c	0.100	0.180	0.260
D	2.850	3.000	3.150
E	2.500	2.750	3.000
E1	1.350	1.500	1.650
e	0.950 BSC		
L	0.200	0.400	0.600
$\theta$	0°	5°	10°

### GENERIC MARKING DIAGRAM\*

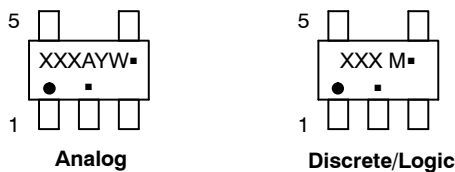

- XXX = Specific Device Code    XXX = Specific Device Code  
 A = Assembly Location        M = Date Code  
 Y = Year                            ▪ = Pb-Free Package  
 W = Work Week
- = Pb-Free Package

(Note: Microdot may be in either location)

\*This information is generic. Please refer to device data sheet for actual part marking. Pb-Free indicator, "G" or microdot "▪", may or may not be present. Some products may not follow the Generic Marking.

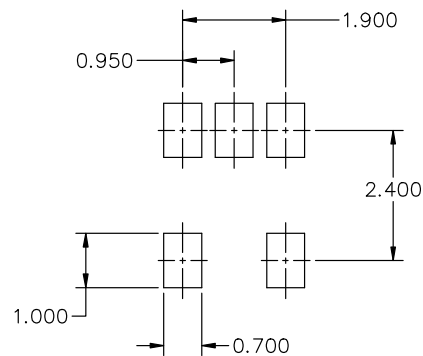

\* FOR ADDITIONAL INFORMATION ON OUR Pb-FREE STRATEGY AND SOLDERING DETAILS, PLEASE DOWNLOAD THE ON SEMICONDUCTOR SOLDERING AND MOUNTING TECHNIQUES REFERENCE MANUAL, SOLDERM/D.

DOCUMENT NUMBER:	98ARB18753C	Electronic versions are uncontrolled except when accessed directly from the Document Repository. Printed versions are uncontrolled except when stamped "CONTROLLED COPY" in red.
DESCRIPTION:	TSOP-5 3.00x1.50x0.95, 0.95P	PAGE 1 OF 1

onsemi and ONSEMI are trademarks of Semiconductor Components Industries, LLC dba onsemi or its subsidiaries in the United States and/or other countries. onsemi reserves the right to make changes without further notice to any products herein. onsemi makes no warranty, representation or guarantee regarding the suitability of its products for any particular purpose, nor does onsemi assume any liability arising out of the application or use of any product or circuit, and specifically disclaims any and all liability, including without limitation special, consequential or incidental damages. onsemi does not convey any license under its patent rights nor the rights of others.

**onsemi**, **Onsemi**, and other names, marks, and brands are registered and/or common law trademarks of Semiconductor Components Industries, LLC dba "**onsemi**" or its affiliates and/or subsidiaries in the United States and/or other countries. **onsemi** owns the rights to a number of patents, trademarks, copyrights, trade secrets, and other intellectual property. A listing of **onsemi**'s product/patent coverage may be accessed at [www.onsemi.com/site/pdf/Patent-Marking.pdf](http://www.onsemi.com/site/pdf/Patent-Marking.pdf). **onsemi** reserves the right to make changes at any time to any products or information herein, without notice. The information herein is provided "as-is" and **onsemi** makes no warranty, representation or guarantee regarding the accuracy of the information, product features, availability, functionality, or suitability of its products for any particular purpose, nor does **onsemi** assume any liability arising out of the application or use of any product or circuit, and specifically disclaims any and all liability, including without limitation special, consequential or incidental damages. Buyer is responsible for its products and applications using **onsemi** products, including compliance with all laws, regulations and safety requirements or standards, regardless of any support or applications information provided by **onsemi**. "Typical" parameters which may be provided in **onsemi** data sheets and/or specifications can and do vary in different applications and actual performance may vary over time. All operating parameters, including "Typicals" must be validated for each customer application by customer's technical experts. **onsemi** does not convey any license under any of its intellectual property rights nor the rights of others. **onsemi** products are not designed, intended, or authorized for use as a critical component in life support systems or any FDA Class 3 medical devices or medical devices with a same or similar classification in a foreign jurisdiction or any devices intended for implantation in the human body. Should Buyer purchase or use **onsemi** products for any such unintended or unauthorized application, Buyer shall indemnify and hold **onsemi** and its officers, employees, subsidiaries, affiliates, and distributors harmless against all claims, costs, damages, and expenses, and reasonable attorney fees arising out of, directly or indirectly, any claim of personal injury or death associated with such unintended or unauthorized use, even if such claim alleges that **onsemi** was negligent regarding the design or manufacture of the part. **onsemi** is an Equal Opportunity/Affirmative Action Employer. This literature is subject to all applicable copyright laws and is not for resale in any manner.

## ADDITIONAL INFORMATION

### TECHNICAL PUBLICATIONS:

Technical Library: [www.onsemi.com/design/resources/technical-documentation](http://www.onsemi.com/design/resources/technical-documentation)  
onsemi Website: [www.onsemi.com](http://www.onsemi.com)

### ONLINE SUPPORT: [www.onsemi.com/support](http://www.onsemi.com/support)

For additional information, please contact your local Sales Representative at [www.onsemi.com/support/sales](http://www.onsemi.com/support/sales)