



The Future of Analog IC Technology®

EV3428A-L-00A

19A, 600kHz 20V Wide Input Synchronous Boost Converter EV Board

DESCRIPTION

The EV3428A-L-00A Evaluation Board is designed to demonstrate the performances of MPS' MP3428A, which has excellent protection and can provide load with 12V/2A power from typical 3.3V input.

The MP3428A is a 600 kHz fixed frequency, high efficiency, wide input range, current mode boost converter with optional internal or external current sensing configuration for high integration and high power application. It features internally a 10mΩ, 24V power switch and a synchronous gate driver for high conversion efficiency. The MP3428A is available in a low profile 22-pin 3mmx4mm QFN package.

This board is configured for 12V application, the maximum output current is determined by current limit, permitted temperature rising and input voltage.

ELECTRICAL SPECIFICATION

Parameter	Symbol	Value	Units
Supply Voltage	V _{IN}	3 – 10	V
Output Voltage	V _{OUT}	12	V
Output Current	I _{OUT}	0– OCP ⁽¹⁾	A

Note:

- maximum output current depends on current limit, permitted temperature rising and input voltage.

FEATURES

- 3V-to-10V⁽²⁾ Wide Input Range
- Integrated 10mΩ Low-side Power FET
- SDR Driver for Synchronous Solution
- 19A Internal Switch Current Limit or External Programmable Input Current Limit
- Input Disconnect and Output SCP Protection
- External Soft-Start and Compensation for Higher Flexibility
- Programmable UVLO and Hysteresis
- < 1μA Shutdown Current
- Thermal Shutdown at 150°C
- Available in 3x4mm QFN-22 Package

Note:

- 3V-to-10V is suggested for this evaluation board, MP3428A IN pin can support up to 20V voltage.

APPLICATIONS

- Thunderbolt Interface
- Notebook and Tablet
- Bluetooth Audio
- Power Banks
- Electrical Cigarettes
- POS Systems

All MPS parts are lead-free, halogen free, and adhere to the RoHS directive. For MPS green status, please visit MPS website under Quality Assurance.

"MPS" and "The Future of Analog IC Technology" are Registered Trademarks of Monolithic Power Systems, Inc.

EV3428A-L-00A EVALUATION BOARD



(L × W × H) 6.3cm × 6.3cm × 1.3cm

EV3428A-L-00A	MP3428AGL
EV3428A-L-00A	MP3428A

Efficiency vs. Output Current

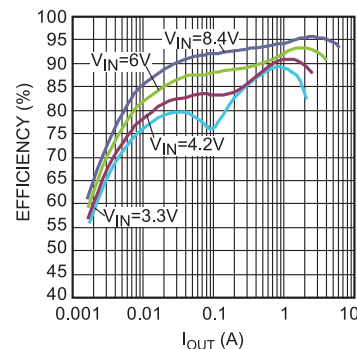

EVALUATION BOARD SCHEMATIC

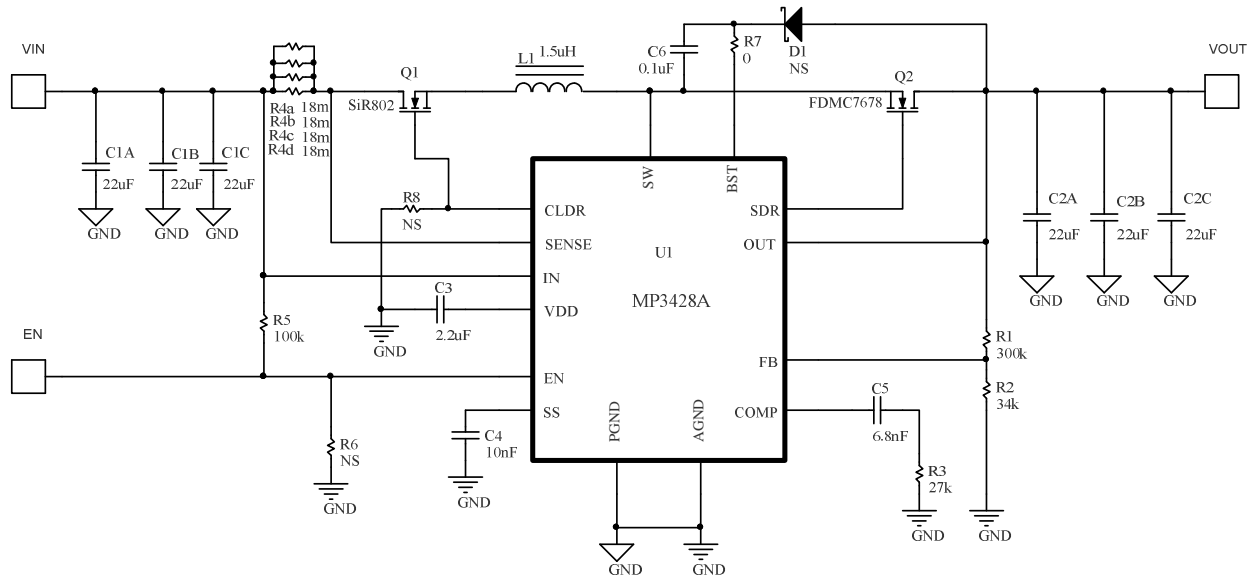

EV3428A-L-00A BILL OF MATERIALS

Qty	Ref	Value	Description	Package	Manufacturer	Manufacturer P/N
6	C1A, C1B, C1C, C2A, C2B, C2C	22 μ F	25V, ceramic Capacitor	1210	muRata	GRM32R71E226KL
1	C3	2.2 μ F	25V, ceramic Capacitor	0805	muRata	GRM21AR71E225KL
1	C4	10nF	50V ceramic capacitor	0603	muRata	GRM188R71H103KL
1	C5	6.8nF	50V ceramic capacitor	0603	muRata	GRM188R71H682KL
1	C6	0.1 μ F	50V, ceramic Capacitor	0603	muRata	GRM188R71H104KL
1	R1	300k	Film resistor, 1%	0603	YAGEO	RC0603FR-07300KL
1	R2	34k	Film resistor, 1%	0603	YAGEO	RC0603FR-0734KL
1	R3	27k	Film resistor, 1%	0603	YAGEO	RC0603FR-0727KL
4	R4a, R4b, R4c, R4d	18m	low ohmic Film resistor, 1%	0805	YAGEO	PR0805FKF070R018L
1	R5	100k	Film resistor, 5%	0603	YAGEO	RC0603JR-07100KL
0	R6, R8	NS		0603		
1	R7	0	Film resistor, 5%	0603	YAGEO	RC0603JR-070RL
0	D1	NS		SOD-323		
1	L1	1.5 μ H	4.3m Ω , 11A inductor	SMD	Würth	744314150
1	Q1	SiR802	20V, 4.6m Ω 18A, N-Channel MOSFET	PowerPAK SO-8	VISHAY	SiR802DP
		SiS612EDNT	20V, 3.2m Ω 19A, N-Channel MOSFET	PowerPAK 1212-8	VISHAY	SiS612EDNT-T1-GE3
1	FDMC7678	Q2	30V, 5.1m Ω 19A, 8.5nC Qg, N-Channel MOSFET	MLP(3X3)	FairChild	FDMC7678
	Si4386		30V, 5.8m Ω ,11A , 11nC, N-Channel MOSFET	SOIC-8	VISHAY	Si4386DY
1	U1	MP3428A	3~20V, 19A, 600kHz boost converter	QFN-22(3X4)	MPS	MP3428AGL

EVB TEST RESULTS

Performance waveforms are tested on the evaluation board.

$V_{IN} = 3.3V$, $V_{OUT} = 12V$, $L = 1.5\mu H$, $I_{OUT}=2A$, $C_{OUT}=22\mu F*3$, $R_{SENSE}=4.5m\Omega$, $T_A = 25^\circ C$, unless otherwise noted.

Efficiency vs. Output Current

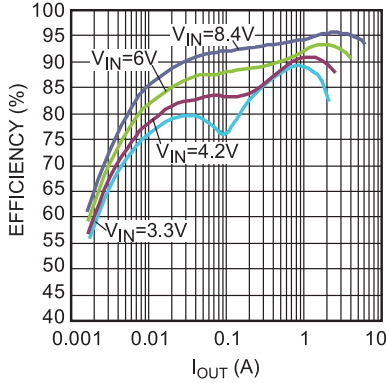

Efficiency vs. Output Current

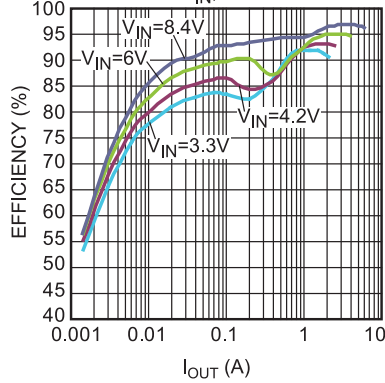

Load Regulation

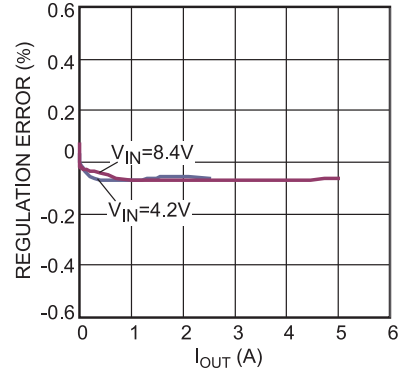

Line Regulation

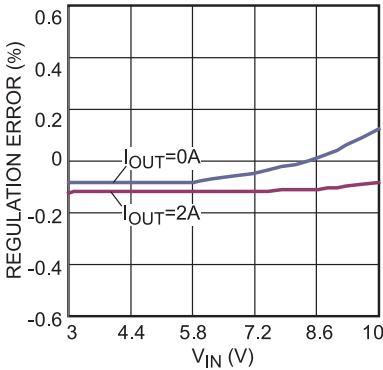

Case Temperature Rise

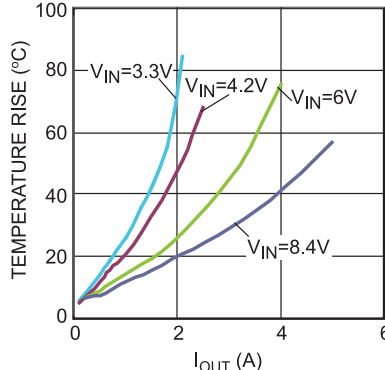

Case Temperature Rise

Remove Q1 and R4, connect L to V_{IN} , $R8=0\Omega$

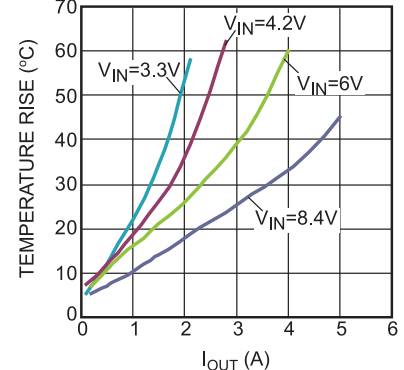

Bode Plot

$V_{IN}=3.3V$, $I_{OUT}=2A$

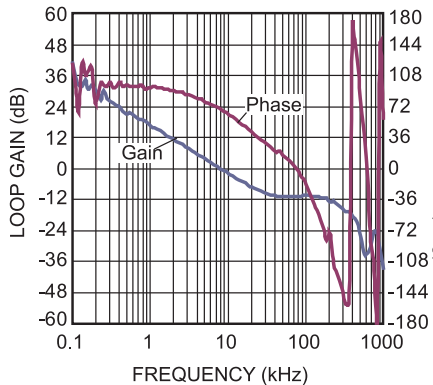

Bode Plot

$V_{IN}=6V$, $I_{OUT}=4A$

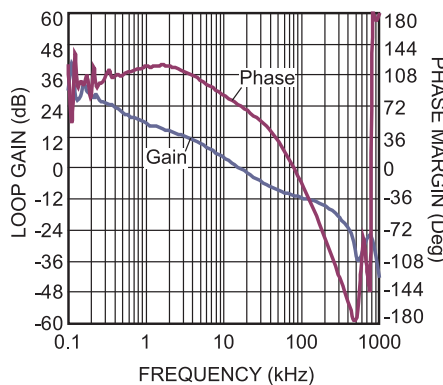

EVB TEST RESULTS (continued)

Performance waveforms are tested on the evaluation board.

$V_{IN} = 3.3V$, $V_{OUT} = 12V$, $L = 1.5\mu H$, $I_{OUT}=2A$, $C_{OUT}=22\mu F \times 3$, $R_{SENSE}=4.5m\Omega$, $T_A = 25^\circ C$, unless otherwise noted.

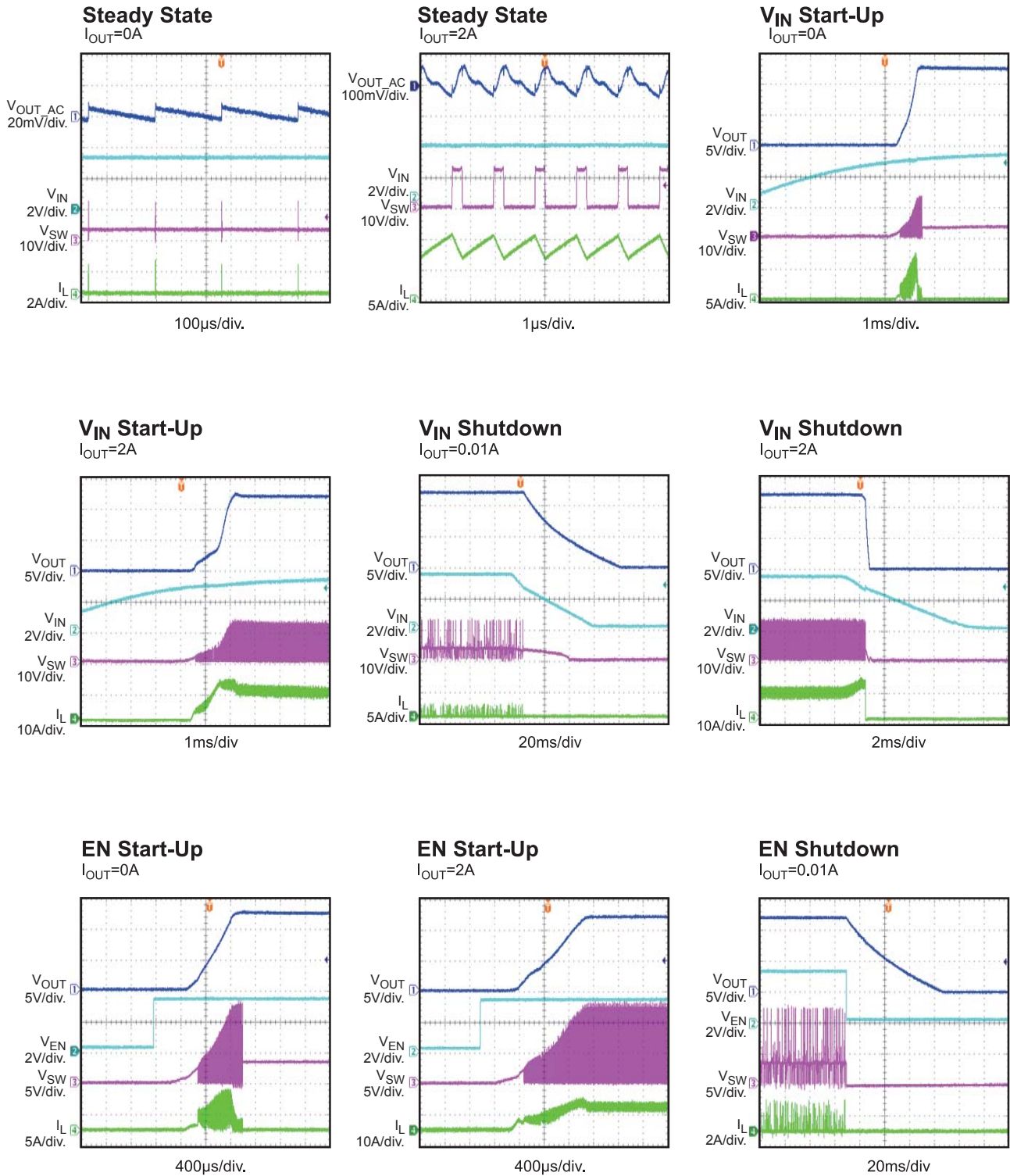

0)
1)

EVB TEST RESULTS (continued)

Performance waveforms are tested on the evaluation board.

$V_{IN} = 3.3V$, $V_{OUT} = 12V$, $L = 1.5\mu H$, $I_{OUT}=2A$, $C_{OUT}=22\mu F*3$, $R_{SENSE}=4.5m\Omega$, $T_A = 25^\circ C$, unless otherwise noted.

EN Shutdown

$I_{OUT}=2A$

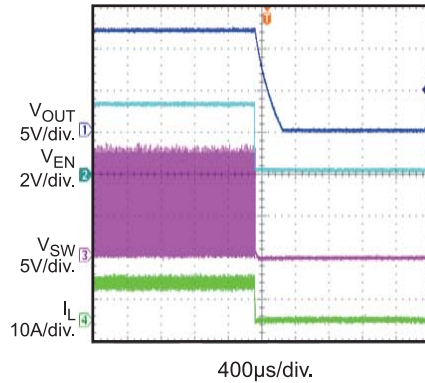

Response to Transient Load

$V_{IN}=6V$, $I_{OUT}=0.1A$ to $1A@25mA/\mu s$

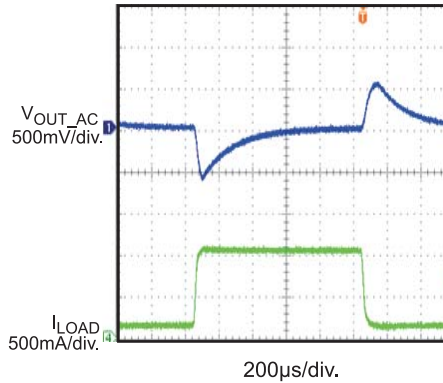

Response to Transient Load

$V_{IN}=6V$, $I_{OUT}=1A$ to $2A@25mA/\mu s$

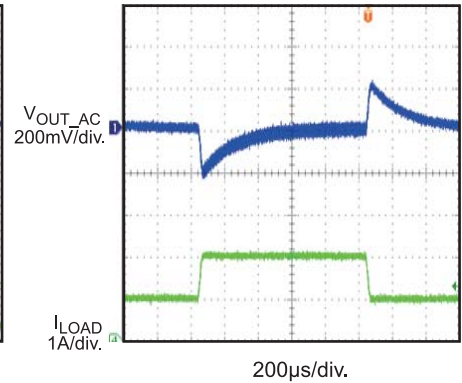

Response to Output Short

$I_{OUT}=2A$

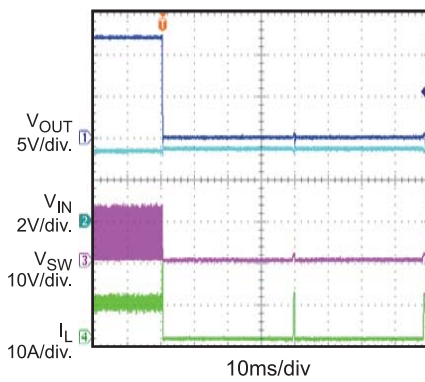

Recovery from Output Short

$I_{OUT}=2A$

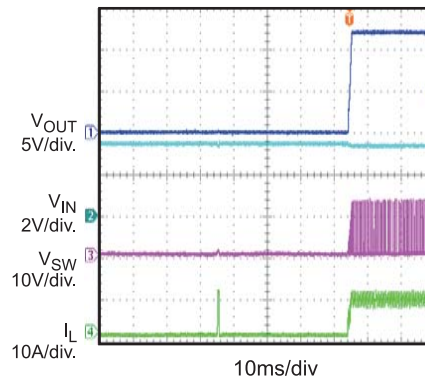

PRINTED CIRCUIT BOARD LAYOUT

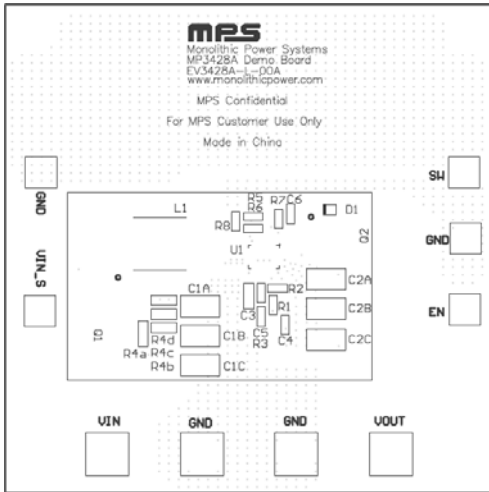

Figure 1: Top Silkscreen Layer

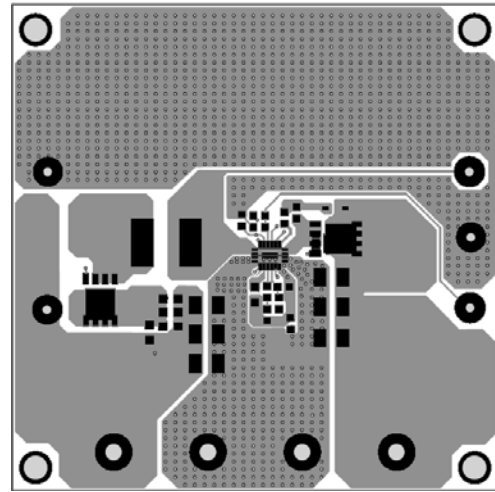

Figure 2: Top Layer

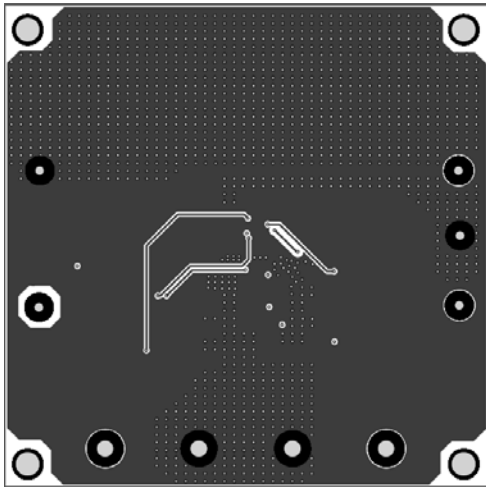

Figure 3: Middle Layer 1

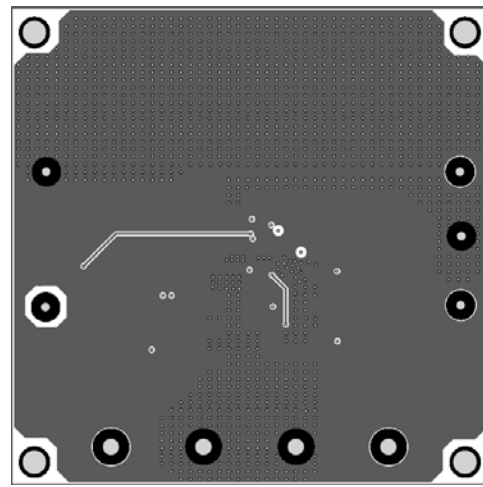

Figure 4: Middle Layer 2

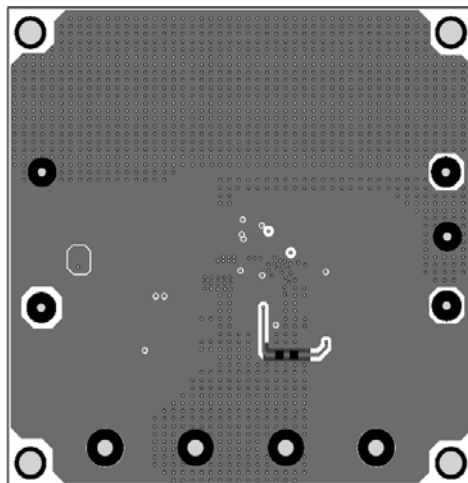

Figure 5: Bottom Layer

QUICK START GUIDE

The output voltage of this board is set to 12V. The board layout accommodates most commonly used inductors and output capacitors. With an input ranging from 3V to 10V, this board can provide load with 3A current from 6V input or 2A current from 3.3V input. To use this EVB for evaluation, you can do as below:

1. Preset Power Supply to between 3V and 10V.
2. Turn Power Supply off.
3. Preset Load to a value, for example, 2A.
4. Connect Power Supply terminals to:
 - a. Positive (+): VIN
 - b. Negative (-): GND
5. Connect Load to:
 - a. Positive (+): VOUT
 - b. Negative (-): GND
5. Turn Power Supply on after making connections. The MP3428A will automatically startup to work.

The output voltage VOUT can be programmed by changing R2. And the value of R2 can be calculated by the following formula:

$$R2 = R1 \times \frac{V_{FB}}{V_{OUT} - V_{FB}}$$

Where R1=300kΩ, and V_{FB}=1.225V.

If EN functions is preferred, apply a high level (>1.39V) turns on MP3428A, low level (<0.4V) turns off MP3428A. After being turned off, output voltage will be discharged to 0V due to input disconnect function.

The default configuration of this board is using external sensing resistor. To use the internal sensing block, first shut off power supply, then connect CLDR pin (find it by looking for R8 on the board) to GND through R8 of which the value should be 0Ω. After power-on, MP3428A automatically uses internal sensing resistor.

NOTICE: The information in this document is subject to change without notice. Please contact MPS for current specifications. Users should warrant and guarantee that third party Intellectual Property rights are not infringed upon when integrating MPS products into any application. MPS will not assume any legal responsibility for any said applications.