

6-100525-3 ✓ ACTIVE

Z-PACK | Z-PACK 2mm HM

TE Internal #: 6-100525-3

Coding Key, Pastel Orange, Z-PACK 2mm HM

[View on TE.com >](#)



Connectors > Connector Accessories > Connector Hardware

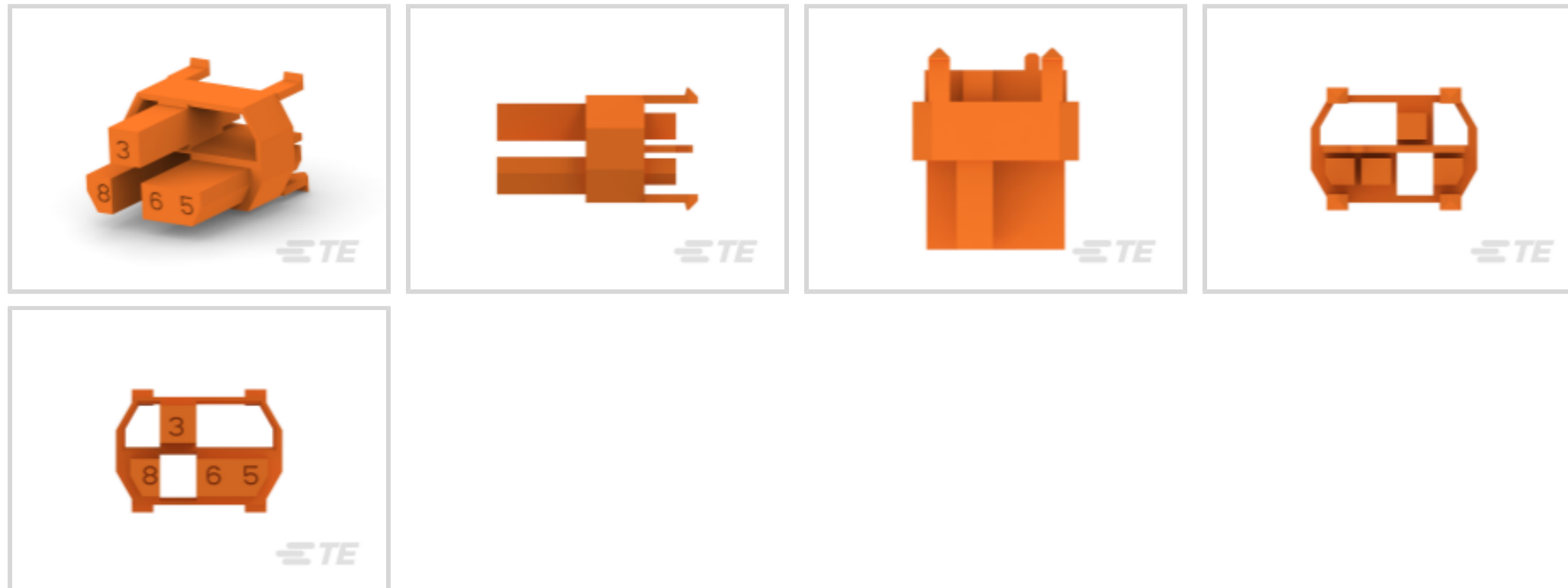

Hardware Accessory Function: **Coding & Keying**

Connector Hardware Accessory Type: **Coding Key**

Primary Product Color: **Pastel Orange**

## Features

### Product Type Features

|                                   |                 |
|-----------------------------------|-----------------|
| Hardware Accessory Function       | Coding & Keying |
| Connector Hardware Accessory Type | Coding Key      |

### Body Features

|                         |               |
|-------------------------|---------------|
| Connector & Keying Code | 3568          |
| Primary Product Color   | Pastel Orange |

### Usage Conditions

|                                 |      |
|---------------------------------|------|
| Compatible With Connector Style | Plug |
|---------------------------------|------|

### Packaging Features

|                    |     |
|--------------------|-----|
| Packaging Quantity | 500 |
| Packaging Method   | Bag |

## Product Compliance

[For compliance documentation, visit the product page on TE.com>](#)

|   |   |
|---|---|
| EU RoHS Directive 2011/65/EU                  | Compliant                               |
| EU ELV Directive 2000/53/EC                   | Compliant                               |
| China RoHS 2 Directive MIIT Order No 32, 2016 | No Restricted Materials Above Threshold |

EU REACH Regulation (EC) No. 1907/2006

Current ECHA Candidate List: JUNE 2024 (241)

Candidate List Declared Against: JUNE 2024 (241)

Does not contain REACH SVHC

Halogen Content

Low Halogen - Br, Cl, F, I < 900 ppm per homogenous material. Also BFR/CFR/PVC Free

Solder Process Capability

Not applicable for solder process capability

Product Compliance Disclaimer

This information is provided based on reasonable inquiry of our suppliers and represents our current actual knowledge based on the information they provided. This information is subject to change. The part numbers that TE has identified as EU RoHS compliant have a maximum concentration of 0.1% by weight in homogenous materials for lead, hexavalent chromium, mercury, PBB, PBDE, DBP, BBP, DEHP, DIBP, and 0.01% for cadmium, or qualify for an exemption to these limits as defined in the Annexes of Directive 2011/65/EU (RoHS2). Finished electrical and electronic equipment products will be CE marked as required by Directive 2011/65/EU. Components may not be CE marked. Additionally, the part numbers that TE has identified as EU ELV compliant have a maximum concentration of 0.1% by weight in homogenous materials for lead, hexavalent chromium, and mercury, and 0.01% for cadmium, or qualify for an exemption to these limits as defined in the Annexes of Directive 2000/53/EC (ELV). Regarding the REACH Regulation, the information TE provides on SVHC in articles for this part number is based on the latest European Chemicals Agency (ECHA) 'Guidance on requirements for substances in articles' posted at this URL: <https://echa.europa.eu/guidance-documents/guidance-on-reach>

## Compatible Parts



## Also in the Series | Z-PACK 2mm HM

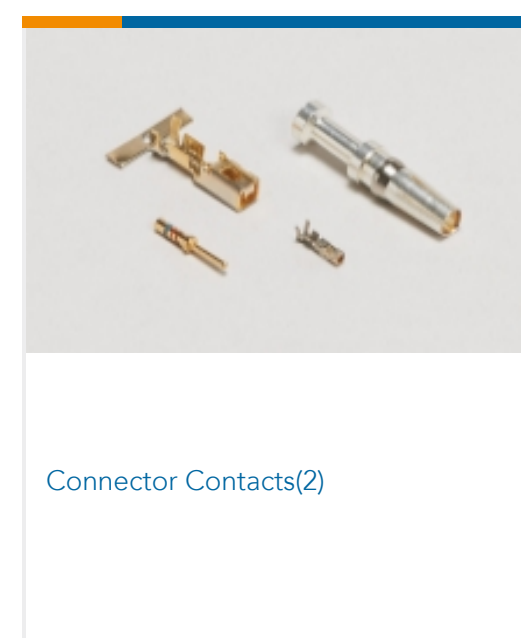
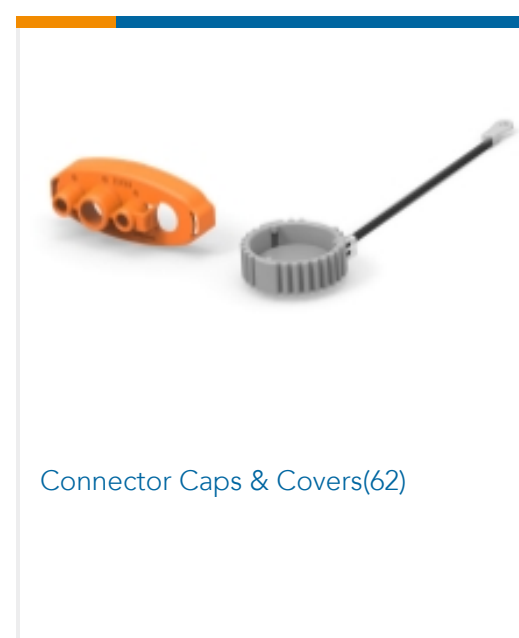
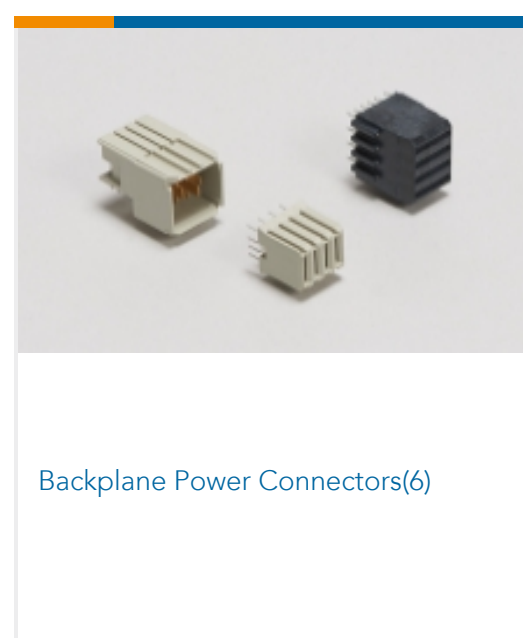
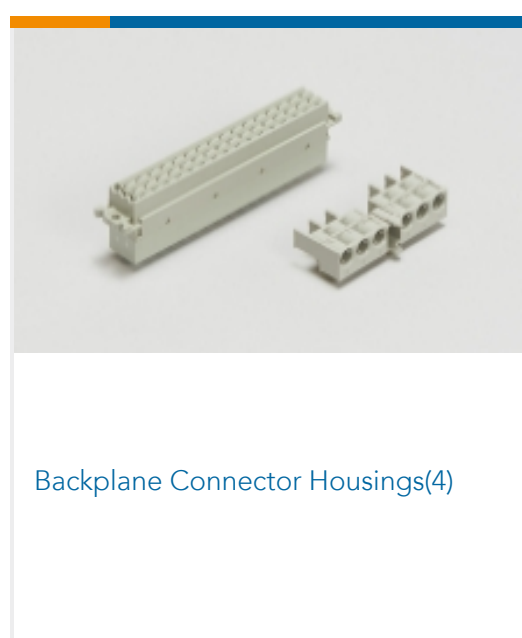



Connector Hardware(97)

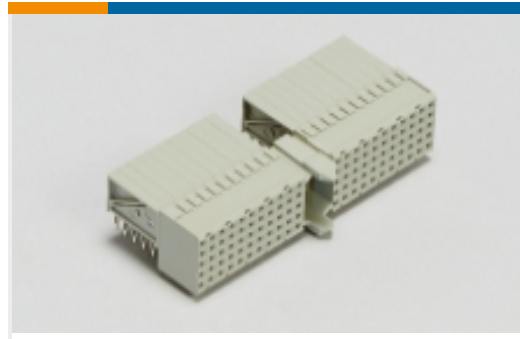

Hard Metric Backplane Connectors (267)

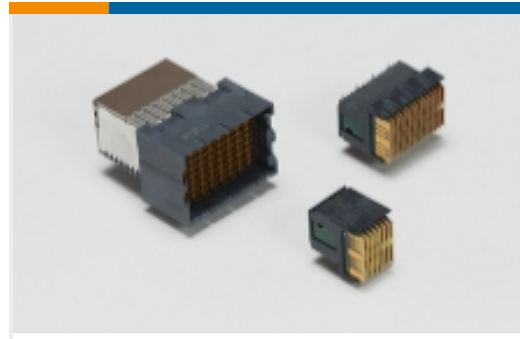

High Speed Backplane Connectors(1)

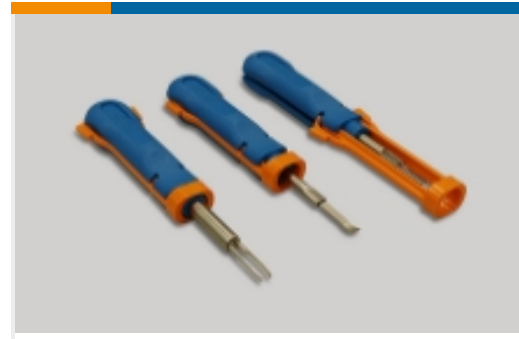

Insertion & Extraction Tools(2)



Rectangular Power Connectors(87)

## Customers Also Bought



TE Part #5352152-1  
Z-PACK/B22 RAF 110P



TE Part #1-1827864-4  
DYNAMIC 1200D REC HSG 8P X  
BLACK



TE Part #5146888-1  
1FHP,64,30A/S,S,C,S10,12,13,15

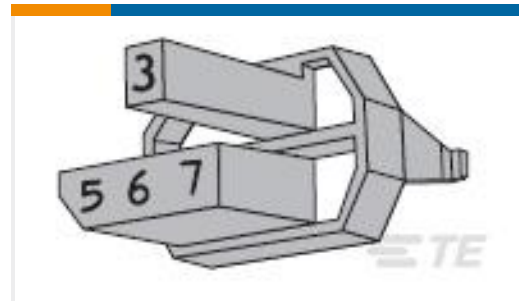

TE Part #5-100526-4  
CODING DEV INSRT COLOR GREEN



TE Part #172211-4  
EIS CAP HSG FREE HANG 4P  
NATUTURAL



TE Part #2007198-1  
SFP+ 1x1 Cage Assembly, Press-



TE Part #171825-4  
TYPE V EIS CONNECTOR 4P ASSY



TE Part #NB15982001  
RT-375-1/4-X-STK



TE Part #3-1414937-3  
V23134J0065X497-EV-CBOX

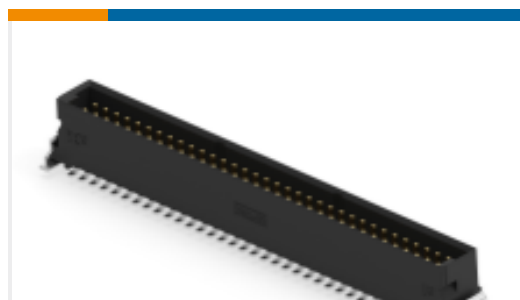

TE Part #244839-E  
SMCQ 68 M AB VV 8-13 CL \* H007 137  
E005

## Documents



## Product Drawings

### CODING DEV INSRT COLOR ORANGE

English

---

## CAD Files

### 3D PDF

3D

#### Customer View Model

[ENG\\_CVM\\_CVM\\_6-100525-3\\_C.2d\\_dxf.zip](#)

English

#### Customer View Model

[ENG\\_CVM\\_CVM\\_6-100525-3\\_C.3d\\_igs.zip](#)

English

#### Customer View Model

[ENG\\_CVM\\_CVM\\_6-100525-3\\_C.3d\\_stp.zip](#)

English

By downloading the CAD file I accept and agree to the [Terms and Conditions](#) of use.

---

## Product Specifications

### Application Specification

English