



SCHROFF

Project - 0 item(s)

MY PROJECT LIST

- PRODUCTS
- APPLICATIONS
- INDUSTRIES
- NEW PRODUCTS
- CONFIGURATORS
- Products ▾
- Search

Home > Handle, static, trapeziform, aluminum

Handle, static, trapeziform, aluminum

SCHROFF

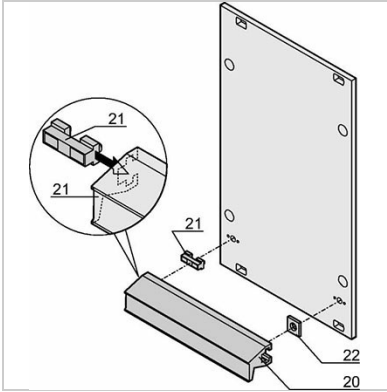

Other Views

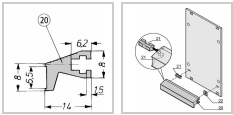

Catalog Number: 20809-287

[Back To Product](#)

- Aluminium profile handle

Note:

Only PCB bracket 60807-011 can be used Fixing materials M2.5 pan head screw x 12FPCS PCB brackets are unsuitable

Specification:

IEC 60297-3-101

Handle:

AL Profile

Type:

Individual Components

Standard:

VME

Individual Component Type:

Handle

Standard pack quantity (SPQ):

Please take into consideration that deliveries may be carried out in the stated SPQs (SPQ, e.g. 5 pieces, 10 pieces, 50 pieces, etc.). Differing order quantities (e.g. 2 pieces) may be changed to the next possible delivery quantity = Standard Pack Quantity.

Delivery Includes:

kit

Product family:

Plug-in units



Select product specifications before modifying or adding to project list or requesting a quote.

Width-HP-defining

[Clear Selection](#)

Quantity

Add Item to Project List +

Documents

Main Catalog - Plug-in units

Links

Native CAD files

Technical Data

Width mm	44.3
Qty	1 piece (SPQ 10)
Delivery is exclusively made in Standard Pack Quantity (SPQ)	10
Material	Al, Anodized
Width HP	9

Delivery Comprises:

20	1	Al extrusion, anodised
21	1	Fixing parts, POM, black
22	1	Square nut, St, nickel-plated

Accessories

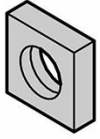

Square nut, M2.5, St, nickel-plated, PU 100 pieces 21100-359

Add Item to Project List +

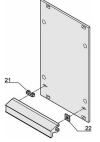

Fixing part for Al profile handle, 100 pieces 21100-476

Add Item to Project List +

EXPLORE

- About Us
- Services & Capabilities
- News & Events
- Newsletter Subscriptions
- Strategic Partnerships
- Investor Relations

CONTACT

- Customer Service
- Find a Sales Office or Distributor
- Global Locations
- Product Compliance & Certifications
- Partner Login

DOWNLOAD

- Download Center
- Reference Projects
- Videos
- Product Configurators
- Warranties and Terms of Sale & Procurement

© 2018 nVent. All rights reserved | [Privacy Policy](#) | [Terms of Use](#) | [Cookie Policy](#) | [Imprint](#) | [Site Map](#)

Connect With Us

