

X5 Frequency Multiplier

RMK-5-571+

50Ω Output 350 to 575 MHz



CASE STYLE: TTT1114

The Big Deal

- High input power, +22 to +24 dBm
- Low conversion loss, 22 dB typ.
- Excellent harmonic suppression, F4, 43 dBc; F6, 42 dBc typ.

Product Overview

Mini-Circuits' RMK-5-571+ is a surface mount frequency multiplier with a multiplication factor of 5, converting input frequencies of 70 to 115 MHz into output frequencies of 350 to 575 MHz. It provides high input power handling with low conversion loss and excellent harmonic suppression. The multiplier comes housed in a shielded 6-lead surface-mount package (0.38 x 0.50 x 0.15") with wraparound terminations for excellent solderability.

Feature	Advantages
Low conversion loss, 22 dB typ.	Low conversion loss results in higher output signal power, reducing the need for amplification at later stages.
Excellent harmonic suppression: <ul style="list-style-type: none">• F4, 40 dBc• F6, 40 dBc	Reduces spurious signals and the need for additional filtering. Reduces spectral regrowth in multiple-channel systems.
High input power +22 to +24 dBm	High input power handling accommodates high input signal levels while maintaining a low conversion loss.
Low cost	Provides an easy, cost-effective solution for generating high-frequency signals from a lower frequency signal source.
Small size (0.38 x 0.50 x 0.15")	Saves space in dense circuit board layouts.

Notes

- A. Performance and quality attributes and conditions not expressly stated in this specification document are intended to be excluded and do not form a part of this specification document.
B. Electrical specifications and performance data contained in this specification document are based on Mini-Circuit's applicable established test performance criteria and measurement instructions.
C. The parts covered by this specification document are subject to Mini-Circuits standard limited warranty and terms and conditions (collectively, "Standard Terms"); Purchasers of this part are entitled to the rights and benefits contained therein. For a full statement of the Standard Terms and the exclusive rights and remedies thereunder, please visit Mini-Circuits' website at www.minicircuits.com/MCLStore/terms.jsp



X5 Frequency Multiplier

50Ω Output 350 to 575 MHz

RMK-5-571+



CASE STYLE: TTT1114

+RoHS Compliant

The +Suffix identifies RoHS Compliance. See our web site for RoHS Compliance methodologies and qualifications



Available Tape and Reel at no extra cost

Reel Size	Devices/Reel
7"	10, 20, 50, 100, 200
13"	500

Maximum Ratings

Operating Temperature	-40°C to 85°C
Storage Temperature	-55°C to 100°C
RF Input Power	25 dBm

Permanent damage may occur if any of these limits are exceeded.

Pin Connections

INPUT	2
OUTPUT	1
GROUND	3,4,5,6

Features

- higher input power, +23 dBm
- low conversion loss, 22 dB typ.
- high adjacent harmonic rejection, F4, 43 dBc typ., F6, 42 dBc typ.
- aqueous washable

Applications

- synthesizers
- local oscillators
- satellite up and down converters

Electrical Specifications at 25°C

Parameter	Min.	Typ.	Max.	Unit
Multiplier Factor		5		
Frequency Range, Input (F1)		70-115		MHz
Frequency Range, Output (F5)		350-575		MHz
Input Power	22		24	dBm
Conversion Loss	—	21	25.5	dB
Harmonic Output*	F1	-3	2	—
	F2	40	58	—
	F3	-9	0	—
	F4	36	43	—
	F6	35	42	—
F7	-2	4	—	

* Harmonics of input frequency below the power level of F5

Outline Drawing

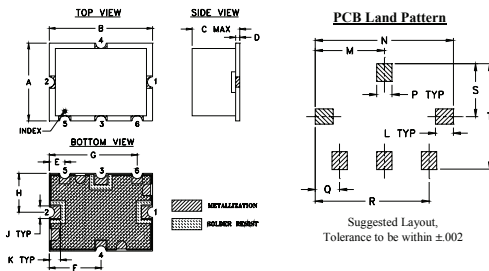

Outline Dimensions (inch/mm)

A	B	C	D	E	F	G	H	J	K
.38	.50	.15	.020	.075	.250	.425	.187	.050	.050
9.65	12.70	3.81	0.51	1.91	6.35	10.80	4.75	1.27	1.27
L	M	N	P	Q	R	S	T	WT.	GRAM
.070	.270	.540	.060	.095	.445	.208	.415		
1.78	6.86	13.72	1.52	2.41	11.30	5.28	10.54		0.8

Demo Board MCL P/N: TB-12 Suggested PCB Layout (PL-079)

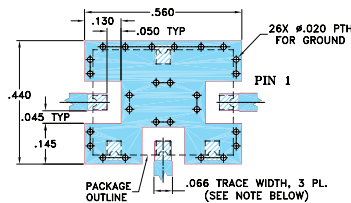

Typical Performance Data

Frequency	Harmonic Rejection Below F5 (dBc) at RF Input Power 22 dBm							
	Input (MHz)	Output (MHz)	Conv. Loss (dB) F5	F1	F2	F3	F4	F6
70	350	22.75	10.65	58.93	3.25	50.77	46.41	3.04
75	375	21.67	10.42	62.95	2.94	63.12	51.35	4.15
80	400	20.96	9.95	52.96	2.34	42.33	40.27	5.30
85	425	20.71	9.21	60.87	1.57	50.02	49.06	6.46
90	450	21.13	7.95	66.13	0.22	61.08	66.37	8.05
95	475	21.82	6.50	67.33	1.13	65.31	63.27	9.71
100	500	22.02	5.41	64.73	2.26	63.86	62.86	10.63
105	525	21.80	4.71	62.50	3.02	61.90	62.61	10.58
110	550	21.90	3.72	60.56	3.97	60.50	61.97	10.65
115	575	22.89	2.02	58.60	5.46	59.39	60.97	12.31

at RF Input Power 24 dBm

70	350	23.58	11.16	55.61	4.02	44.21	39.34	1.89
75	375	22.52	10.95	58.57	3.70	51.46	47.58	3.08
80	400	21.71	10.55	55.91	3.16	46.55	42.78	4.11
85	425	21.16	10.01	54.25	2.60	43.34	41.12	4.85
90	450	20.98	9.26	62.62	1.65	57.49	71.24	5.68
95	475	21.18	8.32	63.46	0.59	59.58	68.73	6.71
100	500	21.45	7.26	62.49	0.58	59.79	66.10	7.42
105	525	21.47	6.37	60.96	1.53	59.31	65.16	7.75
110	550	21.55	5.40	59.41	2.46	58.68	64.34	7.80
115	575	22.05	4.16	57.97	3.64	58.60	63.09	8.33

Notes

- Performance and quality attributes and conditions not expressly stated in this specification document are intended to be excluded and do not form a part of this specification document.
- Electrical specifications and performance data contained in this specification document are based on Mini-Circuit's applicable established test performance criteria and measurement instructions.
- The parts covered by this specification document are subject to Mini-Circuit's standard limited warranty and terms and conditions (collectively, "Standard Terms"); Purchasers of this part are entitled to the rights and benefits contained therein. For a full statement of the Standard Terms and the exclusive rights and remedies thereunder, please visit Mini-Circuit's website at www.minicircuits.com/MCLStore/terms.jsp



www.minicircuits.com P.O. Box 350166, Brooklyn, NY 11235-0003 (718) 934-4500 sales@minicircuits.com

REV. A
M151107
ED16359/2
RMK-5-571+
LC/CP/AM
200813
Page 2 of 3

RMK-5-571+

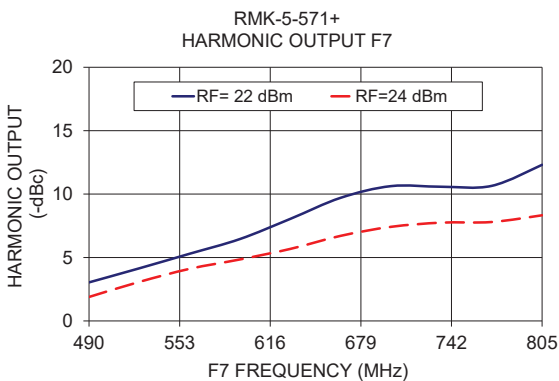
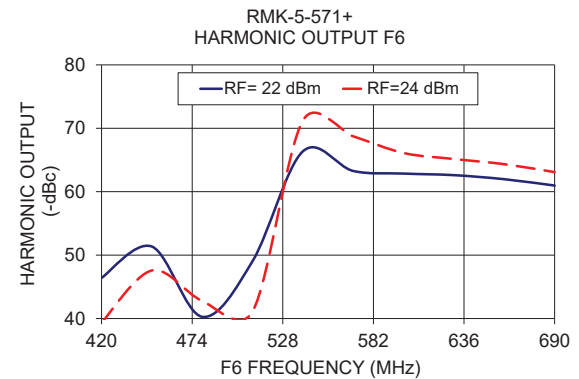
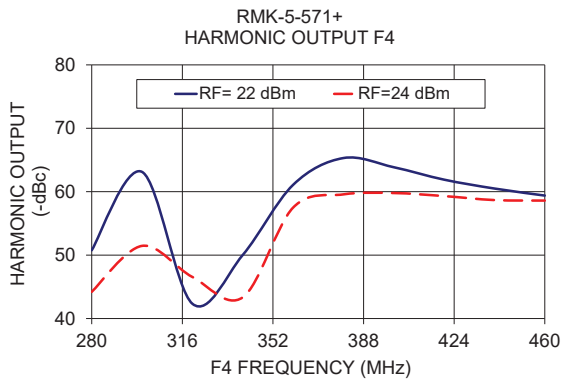
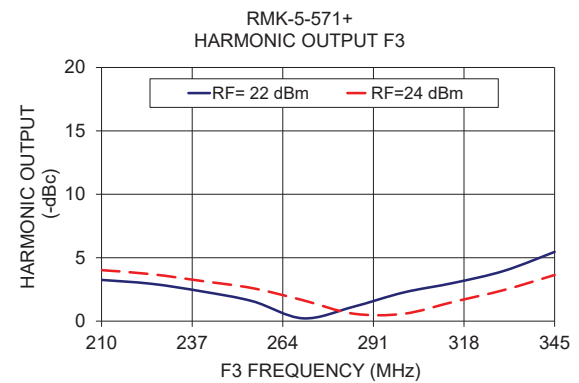
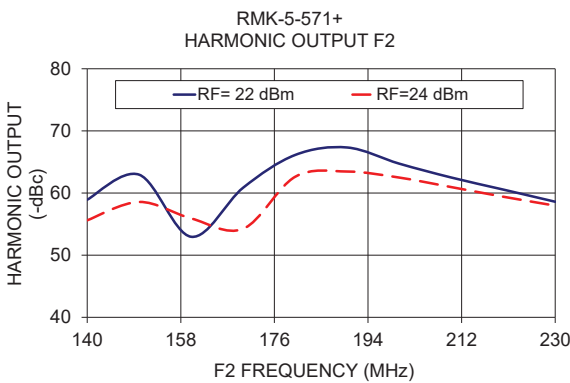
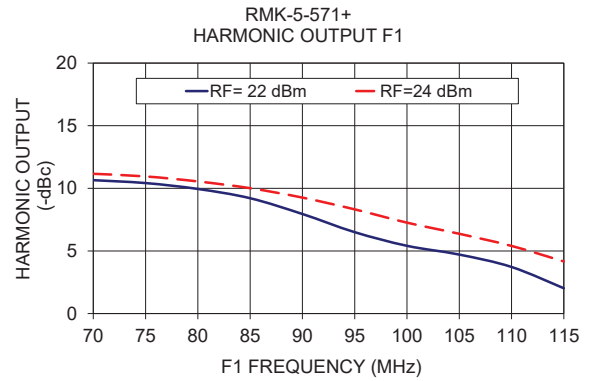
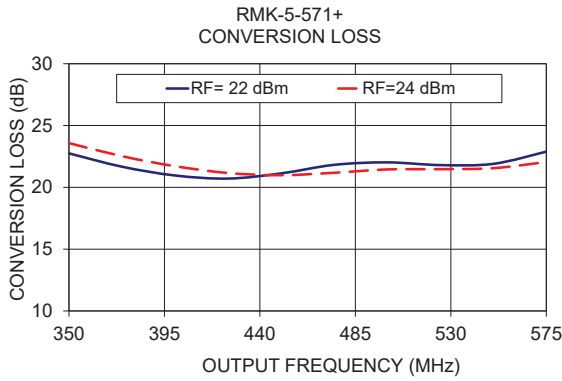

Notes

- A. Performance and quality attributes and conditions not expressly stated in this specification document are intended to be excluded and do not form a part of this specification document.
- B. Electrical specifications and performance data contained in this specification document are based on Mini-Circuit's applicable established test performance criteria and measurement instructions.
- C. The parts covered by this specification document are subject to Mini-Circuits standard limited warranty and terms and conditions (collectively, "Standard Terms"); Purchasers of this part are entitled to the rights and benefits contained therein. For a full statement of the Standard Terms and the exclusive rights and remedies thereunder, please visit Mini-Circuits' website at www.minicircuits.com/MCLStore/terms.jsp



Typical Performance Data

FREQUENCY (MHz)							CONVERSION LOSS (dB)	RF IN = +22 dBm						
								HARMONIC OUTPUT* (-dBc)						
X1 OUTPUT	X2 OUTPUT	X3 OUTPUT	X4 OUTPUT	X5 OUTPUT	X6 OUTPUT	X7 OUTPUT	X5 OUTPUT	X1 OUTPUT	X2 OUTPUT	X3 OUTPUT	X4 OUTPUT	X6 OUTPUT	X7 OUTPUT	
60	120	180	240	300	360	420	25.50	10.71	48.22	3.83	38.28	33.59	1.00	
65	130	195	260	325	390	455	23.92	10.91	56.01	3.46	44.93	40.55	1.90	
70	140	210	280	350	420	490	22.75	10.65	58.93	3.25	50.77	46.41	3.04	
75	150	225	300	375	450	525	21.67	10.42	62.95	2.94	63.12	51.35	4.15	
80	160	240	320	400	480	560	20.96	9.95	52.96	2.34	42.33	40.27	5.30	
85	170	255	340	425	510	595	20.71	9.21	60.87	1.57	50.02	49.06	6.46	
90	180	270	360	450	540	630	21.13	7.95	66.13	0.22	61.08	66.37	8.05	
95	190	285	380	475	570	665	21.82	6.50	67.33	-1.13	65.31	63.27	9.71	
100	200	300	400	500	600	700	22.02	5.41	64.73	-2.26	63.86	62.86	10.63	
105	210	315	420	525	630	735	21.80	4.71	62.50	-3.02	61.90	62.61	10.58	
110	220	330	440	550	660	770	21.90	3.72	60.56	-3.97	60.50	61.97	10.65	
115	230	345	460	575	690	805	22.89	2.02	58.60	-5.46	59.39	60.97	12.31	
120	240	360	480	600	720	840	24.84	-0.43	56.15	-7.47	57.20	60.05	13.79	

* Harmonic Output below power level of X5 Output.

FREQUENCY (MHz)							CONVERSION LOSS (dB)	RF IN = +24 dBm						
								HARMONIC OUTPUT* (-dBc)						
X1 OUTPUT	X2 OUTPUT	X3 OUTPUT	X4 OUTPUT	X5 OUTPUT	X6 OUTPUT	X7 OUTPUT	X5 OUTPUT	X1 OUTPUT	X2 OUTPUT	X3 OUTPUT	X4 OUTPUT	X6 OUTPUT	X7 OUTPUT	
60	120	180	240	300	360	420	26.40	11.12	48.70	4.54	43.62	37.33	-0.27	
65	130	195	260	325	390	455	24.74	11.35	50.93	4.20	41.17	35.64	0.74	
70	140	210	280	350	420	490	23.58	11.16	55.61	4.02	44.21	39.34	1.89	
75	150	225	300	375	450	525	22.52	10.95	58.57	3.70	51.46	47.58	3.08	
80	160	240	320	400	480	560	21.71	10.55	55.91	3.16	46.55	42.78	4.11	
85	170	255	340	425	510	595	21.16	10.01	54.25	2.60	43.34	41.12	4.85	
90	180	270	360	450	540	630	20.98	9.26	62.62	1.65	57.49	71.24	5.68	
95	190	285	380	475	570	665	21.18	8.32	63.46	0.59	59.58	68.73	6.71	
100	200	300	400	500	600	700	21.45	7.26	62.49	-0.58	59.79	66.10	7.42	
105	210	315	420	525	630	735	21.47	6.37	60.96	-1.53	59.31	65.16	7.75	
110	220	330	440	550	660	770	21.55	5.40	59.41	-2.46	58.68	64.34	7.80	
115	230	345	460	575	690	805	22.05	4.16	57.97	-3.64	58.60	63.09	8.33	
120	240	360	480	600	720	840	23.20	2.52	56.53	-5.12	58.35	61.92	9.86	

* Harmonic Output below power level of X5 Output.

Typical Performance Curves

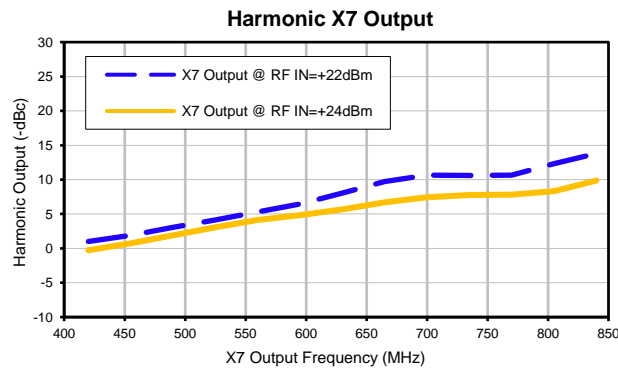
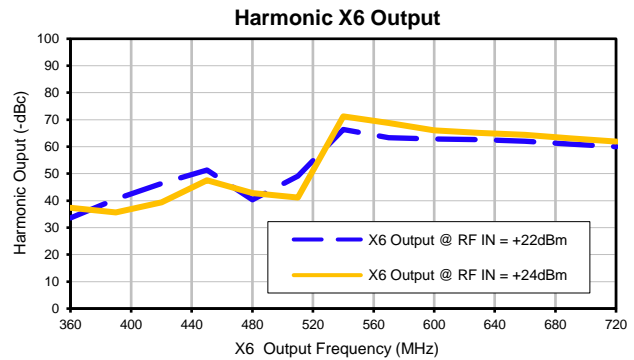
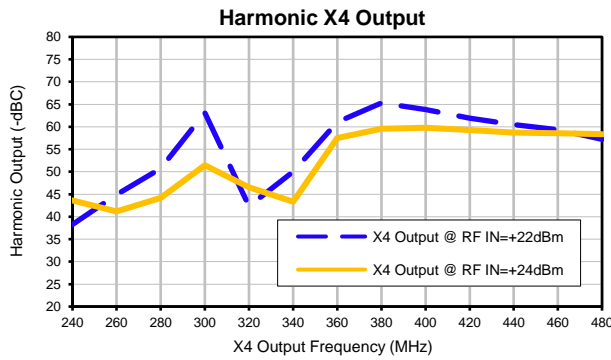
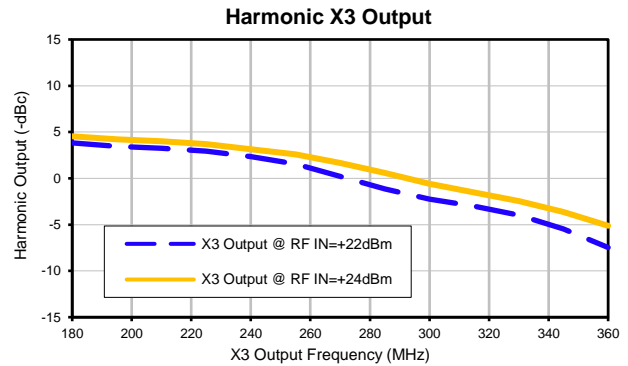
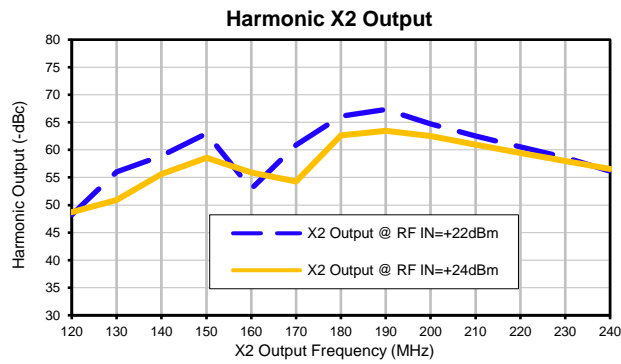
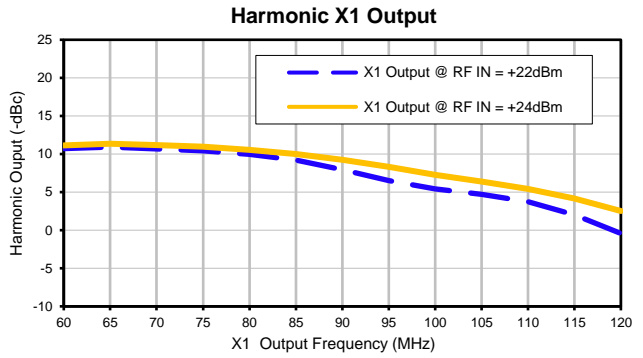
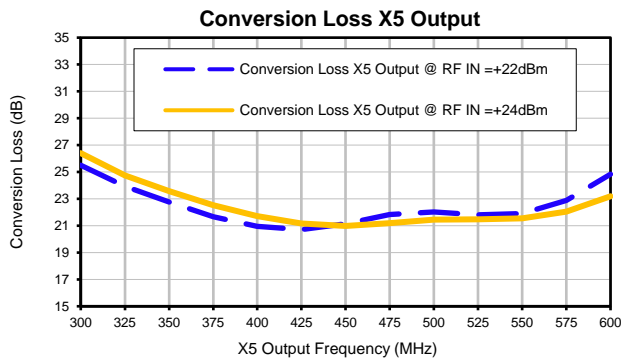

Outline Dimensions

TTT1114

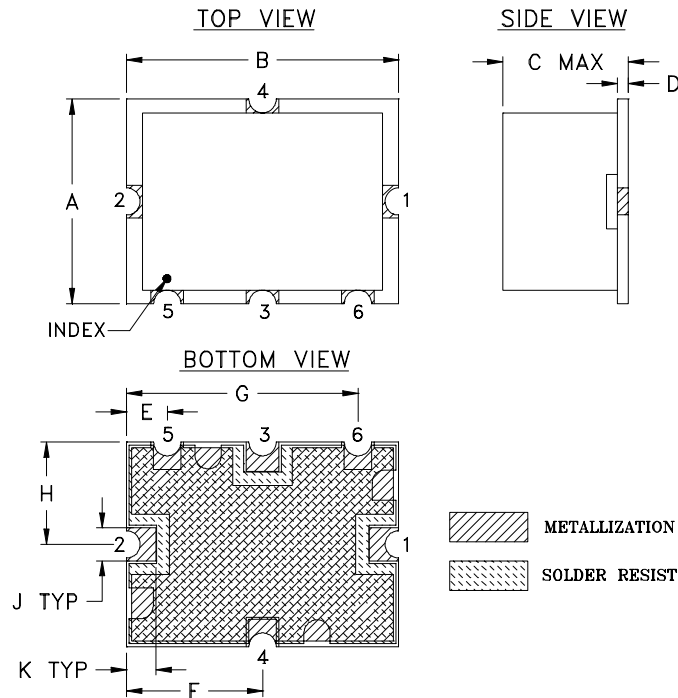

PCB Land Pattern

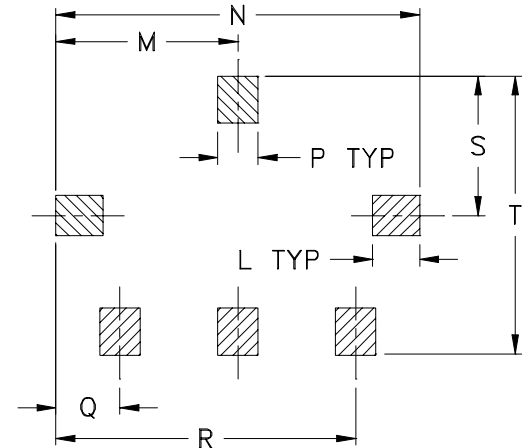

Suggested Layout,
Tolerance to be within $\pm .002$

CASE #	A	B	C	D	E	F	G	H	J	K	L	M	N
TTT1114	.38 (9.65)	.50 (12.70)	.15 (3.81)	.020 (0.51)	.075 (1.91)	.250 (6.35)	.425 (10.80)	.187 (4.75)	.050 (1.27)	.050 (1.27)	.070 (1.78)	.270 (6.86)	.540 (13.72)

CASE #	P	Q	R	S	T	WT. GRAM
TTT1114	.060 (1.52)	.095 (2.41)	.445 (11.30)	.208 (5.28)	.415 (10.54)	.8

Dimensions are in inches (mm). Tolerances: 2 Pl. $\pm .01$; 3 Pl. $\pm .005$

Note:

- Case material: Nickel-Silver alloy.
- Base material: Printed wiring laminate.
- Termination finish:
 - For RoHS Case Styles: 3-5 μ inch (.08-.13 microns) Gold over 120-240 μ inch (3.05-6.10 microns) Nickel plate. All models, (+) suffix.
 - For RoHS -5 Case Style: Tin-Lead plate. All models, no (+) suffix.



INTERNET <http://www.minicircuits.com>

P.O. Box 350166, Brooklyn, New York 11235-0003 (718) 934-4500 Fax (718) 332-4661

Distribution Centers NORTH AMERICA 800-654-7949 • 417-335-5935 • Fax 417-335-5945 • EUROPE 44-1252-832600 • Fax 44-1252-837010

Mini-Circuits ISO 9001 & ISO 14001 Certified

THIRD ANGLE PROJECTION

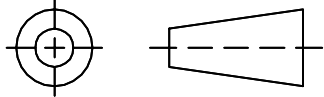

REVISIONS

REV	ECN No.	DESCRIPTION	DATE	DR	AUTH
A	M86762	ADDED CONNECTIONS "lp & lq"	05/23/03	MMG	WL
B	M94598	ADDED CONNECTION "hk"	10/08/04	MMG	HY
C	M102713	UPDATED NOTES & DESCRIPTION	01/14/06	GF	IL
D	M132989	UPDATED NOTE 2	08/24/11	GF	DJ

SUGGESTED MOUNTING CONFIGURATION FOR
 TTT166/167 CASE STYLE, "hk"/"lp"/"lq"
 "x"/"ck"/"ec" PIN CONNECTIONS

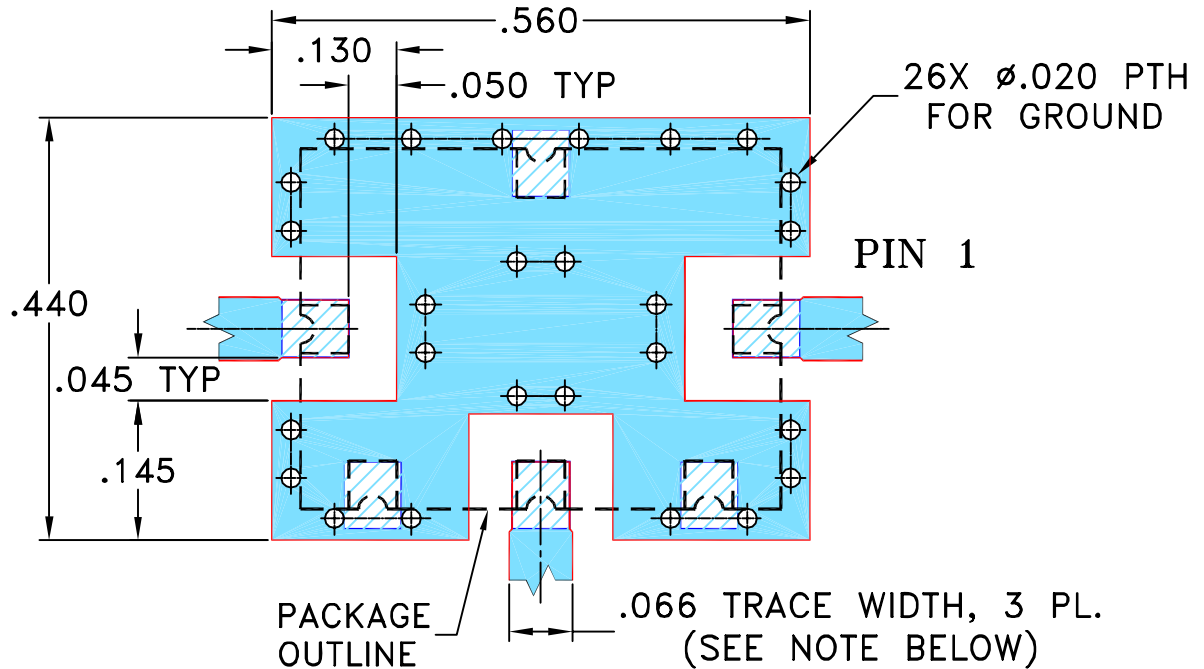

NOTE:

1. TRACE WIDTH IS SHOWN FOR ROGERS R04350B WITH DIELECTRIC THICKNESS .030" ± .002"; COPPER: 1/2 OZ. EACH SIDE. FOR OTHER MATERIALS TRACE WIDTH MAY NEED TO BE MODIFIED.
2. THE USE OF SOLDER MASK OVER THE GROUND AREA UNDER THE UNIT AS SHOWN IS RECOMMENDED TO PREVENT POTENTIAL SHORTING. IF USER CHOOSES TO EXPOSE METAL UNDER THE ENTIRE UNIT GROUND PAD FOR IMPROVED GROUNDING, IT IS RECOMMENDED A SOLDER MASK DAM BE APPLIED AROUND EACH GROUND PAD TO ENSURE FILLET AND CONNECTION AT GROUND PADS.
3. BOTTOM SIDE OF THE PCB IS CONTINUOUS GROUND PLANE.



DENOTES PCB COPPER LAYOUT WITH SMOBC (SOLDER MASK OVER BARE COPPER), SEE NOTE 2.

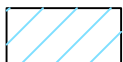

DENOTES COPPER LAND PATTERN FREE OF SOLDER MASK

UNLESS OTHERWISE SPECIFIED

DIMENSIONS ARE IN INCHES
 TOLERANCES ON:
 2 PL DECIMALS ±
 3 PL DECIMALS ± .005
 ANGLES ±
 FRACTIONS ±

	INITIALS	DATE
DRAWN	GF	03/18/03
CHECKED	IL	04/15/03
APPROVED	DJ	04/15/03



Mini-Circuits®

13 Neptune Avenue
 Brooklyn NY 11235

PL, hk/lp/lq/x/ck/ec, TTT166/167,
 SYM/HJK/SYAS/SYPD, TB-12

Mini-Circuits®
 THIS DOCUMENT AND ITS CONTENTS ARE THE PROPERTY OF MINI-CIRCUITS. EXCEPT FOR USE EXPRESSLY GRANTED, IN WRITING, TO ITS VENDORS, VENDEE AND THE UNITED STATES GOVERNMENT, MINI-CIRCUITS RESERVES ALL PROPRIETARY DESIGN, USE, MANUFACTURING AND REPRODUCTION RIGHTS THERETO. THESE CONTENTS SHALL NOT BE USED, DUPLICATED OR DISCLOSED TO ANY OUTSIDE PARTY, IN WHOLE OR IN PART, WITHOUT WRITTEN PERMISSION OF MINI-CIRCUITS.

SIZE A	CODE IDENT 15542	DRAWING NO: 98-PL-079	REV: D
FILE: 98PL079	SCALE: 5:1	SHEET: 1 OF 1	

Evaluation Board and Circuit

For Pin Connections Refer to Data Sheet of the DUT

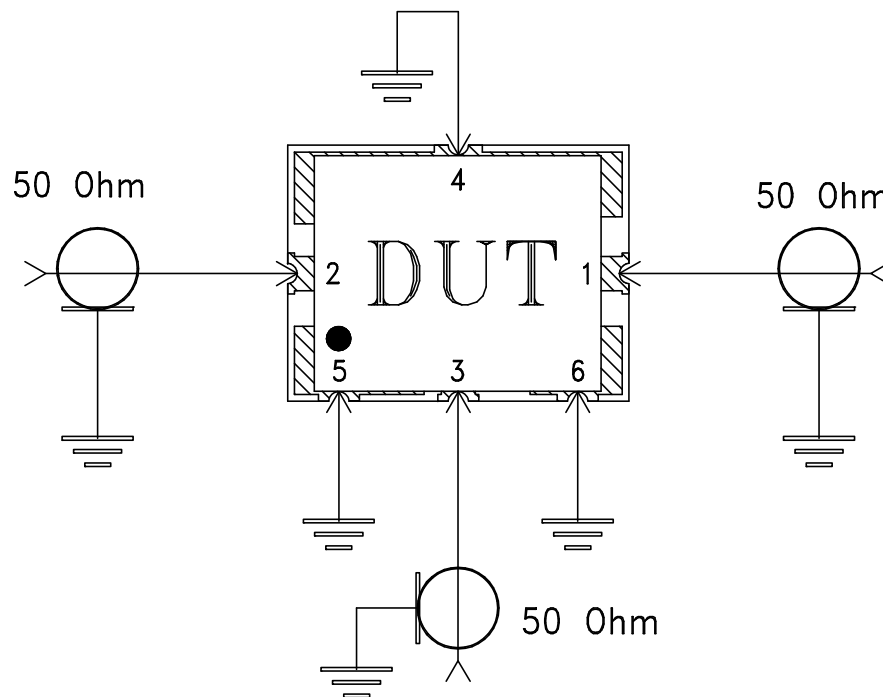
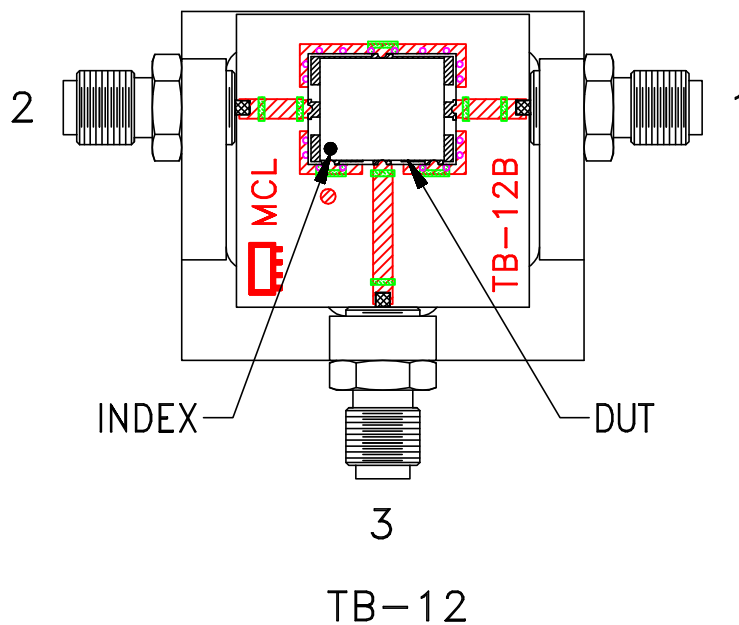

Schematic Diagram

Notes:

1. SMA Female connectors.
2. PCB Material: Rogers R04350 or equivalent, Dielectric Constant=3.5, Thickness=.030 inch.

 **Mini-Circuits®**



All Mini-Circuits products are manufactured under exacting quality assurance and control standards, and are capable of meeting published specifications after being subjected to any or all of the following physical and environmental test.

Specification	Test/Inspection Condition	Reference/Spec
Operating Temperature	-40° to 85°C Ambient Environment	Individual Model Data Sheet
Storage Temperature	-55° to 100° C Ambient Environment	Individual Model Data Sheet
Humidity	90 to 95% RH, 240 hours, 50°C	MIL-STD-202, Method 103, Condition A, Except 50°C and end-point electrical test done within 12 hours
Thermal Shock	-55° to 100°C, 100 cycles	MIL-STD-202, Method 107, Condition A-3, except +100°C
Solder Reflow Heat	Sn-Pb Eutetic Process: 225°C peak Pb-Free Process 245° - 250°C peak	J-STD-020, Table 4-1, 4-2 and 5-2, Figure 5-1
Solderability	10X Magnification	J-STD-002, 95% Coverage
Vibration (High Frequency)	20g peak, 10-2000 Hz, 12 times in each of three perpendicular directions (total 36)	MIL-STD-202, Method 204, Condition D
Mechanical Shock	50g, 11 ms, 1/2-sine, 18 shocks: 3 each direction, each of 3 axes	MIL-STD-202, Method 213, Condition A
Marking Resistance to Solvents	Isopropyl alcohol + mineral spirits at 25°C; terpene defluxer at 25°C; distilled water + proylene glycol monomethyl ether + monoethanolamine at 63°C to 70°C	MIL-STD-202, Method 215