

SOT-23 Dual Common Anode Zeners for ESD Protection 具有靜電保護功能的共陽雙穩壓二極管

■FEATURES 特點

Characteristic 特性參數	Symbol 符號	Max 最大值	Unit 單位
Power dissipation 耗散功率	P_D ($T_a=25^\circ C$)	225	mW
Peak Power dissipation 峰值耗散功率	P_{PK} (5V6A-10VA) (12VA-33VA)	24 40	W
Forward Voltage 正向電壓	V_F (@ $I_F=10mA$)	0.9	V
Reverse Voltage 反向電壓	V_{BR}	5.1-33	V
Junctoin and Storage Temperature 結溫和儲藏溫度	T_J, T_{stg}	125°C, -55to+125°C	

■SOT-23 INTERNAL CONFIGURATION 內部結構

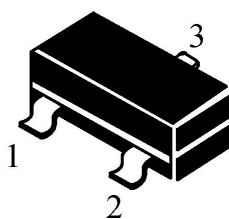
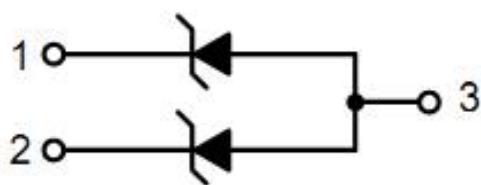

24 and 40 Watt Peak Power Zener Transient Voltage Suppressors

24/40 瓦峰值功率瞬態電壓抑制穩壓管

■ ELECTRICAL CHARACTERISTICS 電特性

($T_A=25^{\circ}\text{C}$ unless otherwise noted 如無特殊說明，溫度為 25°C)

UNIDIRECTIONAL (Circuit tied to Pins 1 and 3 or 2 and 3)

Symbol 符號	Parameter 參數
I_{PP}	Maximum Reverse Peak Pulse Current 最大反向脈衝峰值電流
V_C	Clamping Voltage @ I_{PP} 最大反向脈衝峰值電流下的鉗位電壓
V_{RWM}	Working Peak Reverse Voltage 反向峰值工作電壓
I_R	Maximum Reverse Leakage Current @ V_{RWM} 反向峰值工作電壓下的最大反向漏電流
V_{BR}	Breakdown Voltage @ I_T 測試電流下的擊穿電壓
I_T	Test Current 測試電流
$\Theta_{V_{BR}}$	Maximum Temperature Coefficient of V_{BR} 擊穿電壓的最大溫度效應
I_F	Forward Current 正向電流
V_F	Forward Voltage @ I_F 正向電流下的正向電壓
Z_{ZT}	Maximum Zener Impedance @ I_{ZT} 反向測試電流下的最大阻抗
I_{ZK}	Reverse Current 反向電流
Z_{ZK}	Maximum Zener Impedance @ I_{ZK} 反向電流下的最大阻抗

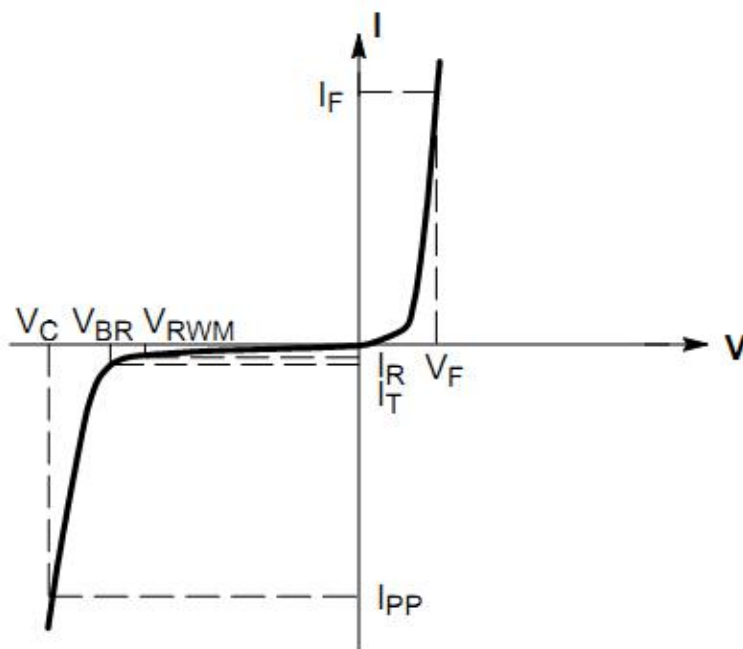

Uni-Directional TVS

UNIDIRECTIONAL (Circuit tied to Pins 1 and 3 or 2 and 3)

Device Number	Device Marking	V _{RWM}	I _R @ V _{RWM}	Breakdown Voltage				Max Zener Impedance			V _C @I _{PP}		ΘV _{BR}
				V _{BR} (V)			@I _T	Z _{ZT} @I _T	Z _{ZK} @I _{ZK}	V _C	I _{PP}		
		V	uA	Min	Nom	Max	mA	Ω	Ω	mA	V	A	mV/°C
MMBZ5V1A	5A1	2.0	2.0	4.85	5.1	5.35	5	80	500	1	7.5	3.0	1.26
MMBZ5V6A	5A6	3.0	5.0	5.32	5.6	5.88	20	11	1600	0.25	8.0	3.0	1.26
MMBZ6V2A	6A2	3.0	0.5	5.89	6.2	6.51	1.0	-	-	-	8.7	2.8	2.80
MMBZ6V8A	6A8	4.5	0.5	6.46	6.8	7.14	1.0	-	-	-	9.6	2.5	3.4
MMBZ9V1A	9A1	6.0	0.3	8.65	9.1	9.56	1.0	-	-	-	14	1.7	7.5
MMBZ10VA	10A	6.5	0.3	9.50	10	10.5	1.0	-	-	-	14	1.7	7.5

UNIDIRECTIONAL (Circuit tied to Pins 1 and 3 or 2 and 3)

Device Number	Device Marking	V _{RWM}	I _R @ V _{RWM}	Breakdown Voltage				V _C @I _{PP}		ΘV _{BR}
				V _{BR} (V)			@I _T	V _C	I _{PP}	
		V	nA	Min	Nom	Max	mA	V	A	mV/°C
MMBZ12VA	12A	8.5	200	11.4	12	12.6	1.0	17	2.35	7.5
MMBZ15VA	15A	12	50	14.25	15	15.75	1.0	21	1.9	12.3
MMBZ18VA	18A	14.5	50	17.10	18	18.90	1.0	25	1.6	15.3
MMBZ20VA	20A	17	50	19.00	20	21.00	1.0	28	1.4	17.2
MMBZ27VA	27A	22	50	25.65	27	28.35	1.0	40	1.0	24.3
MMBZ33VA	33A	26	50	31.35	33	34.65	1.0	46	0.87	30.4

■ **TYPICAL CHARACTERISTIC CURVE 典型特性曲线**

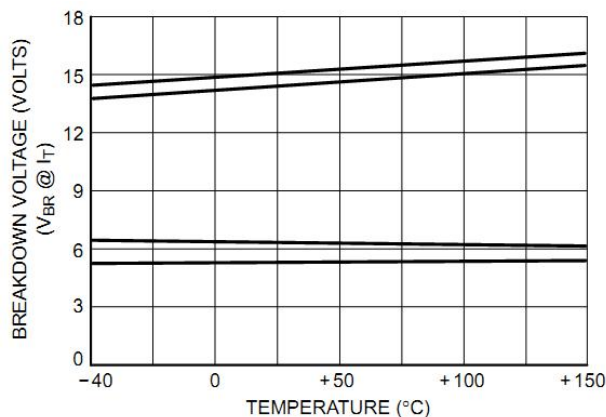

Figure 1. Typical Breakdown Voltage versus Temperature

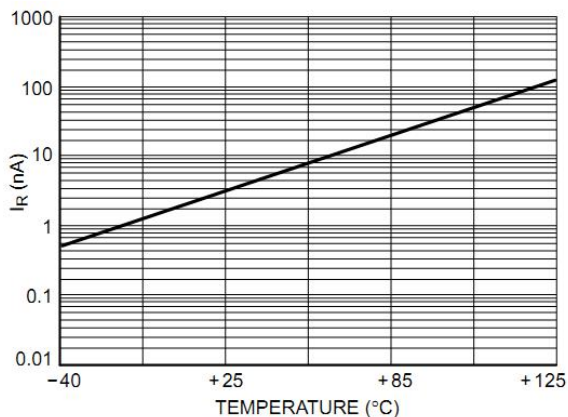

Figure 2. Typical Leakage Current versus Temperature

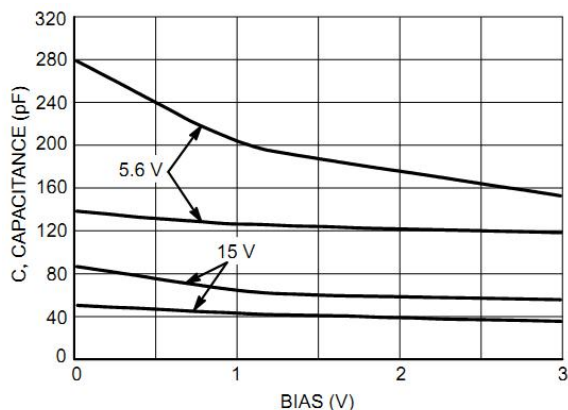

Figure 3. Typical Capacitance versus Bias Voltage

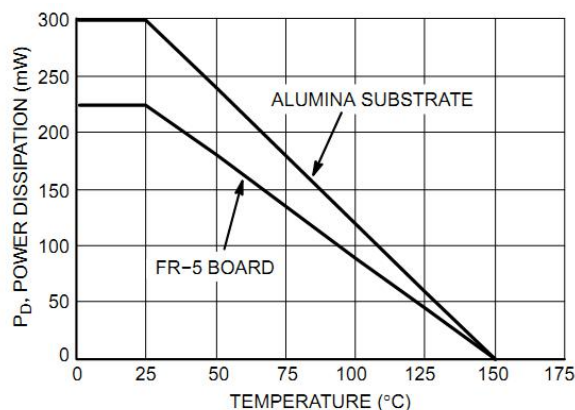

Figure 4. Steady State Power Derating Curve

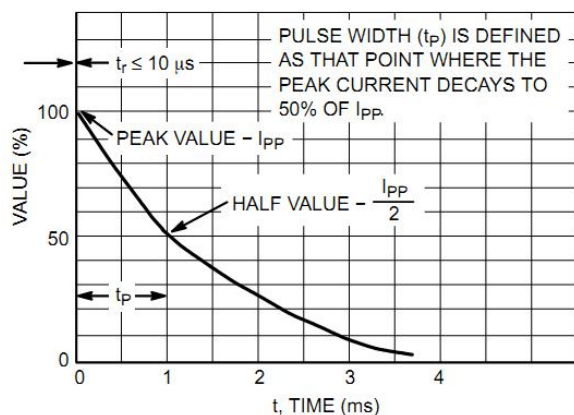

Figure 5. Pulse Waveform

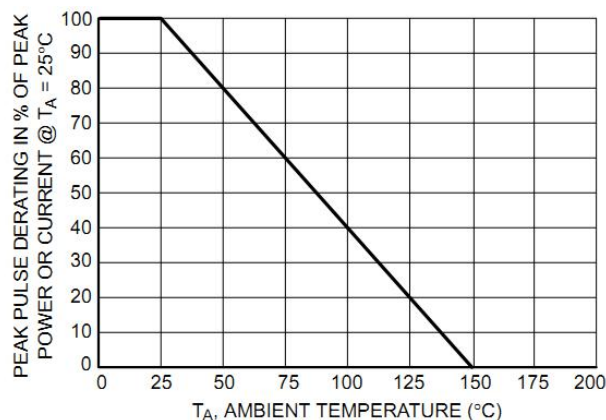
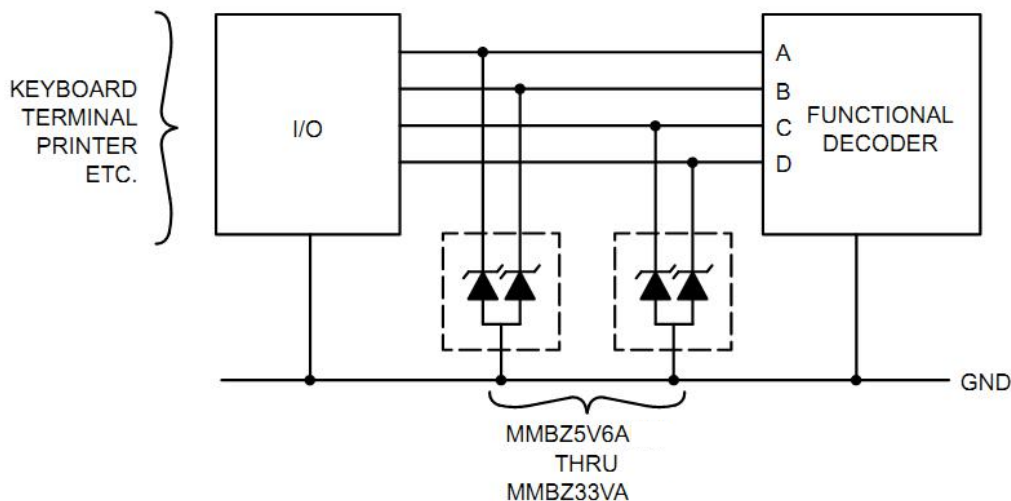

Figure 6. Pulse Derating Curve

■ TYPICAL COMMON ANODE APPLICATIONS 典型共陽極應用

A quad junction common anode design in a SOT-23 package protects four separate lines using only one package. This adds flexibility and creativity to PCB design especially when board space is at a premium. Two simplified examples of TVS applications are illustrated below.

Computer Interface Protection



Microprocessor Protection

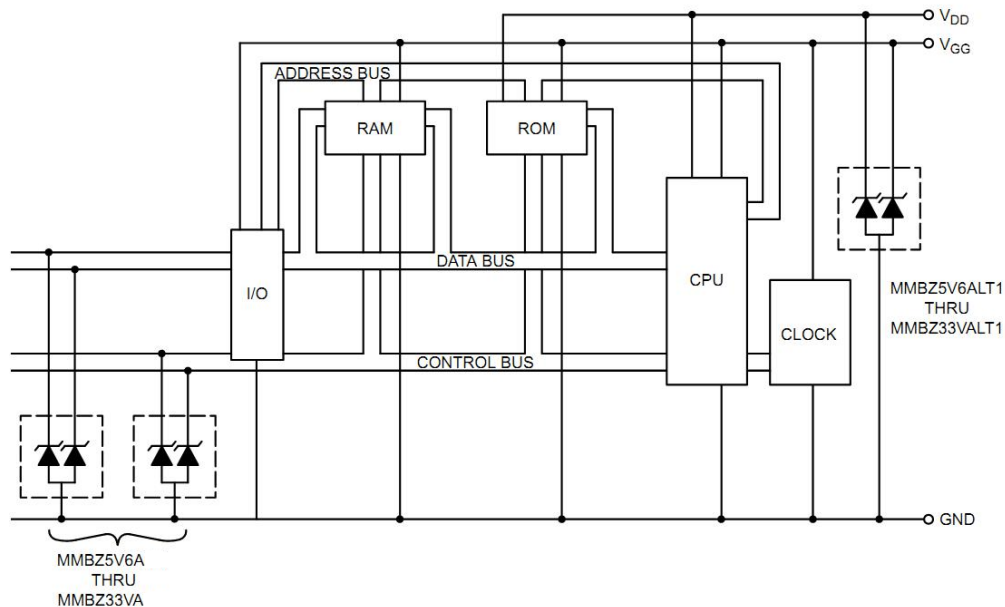

■ DIMENSION 外形封裝尺寸

單位(UNIT): mm

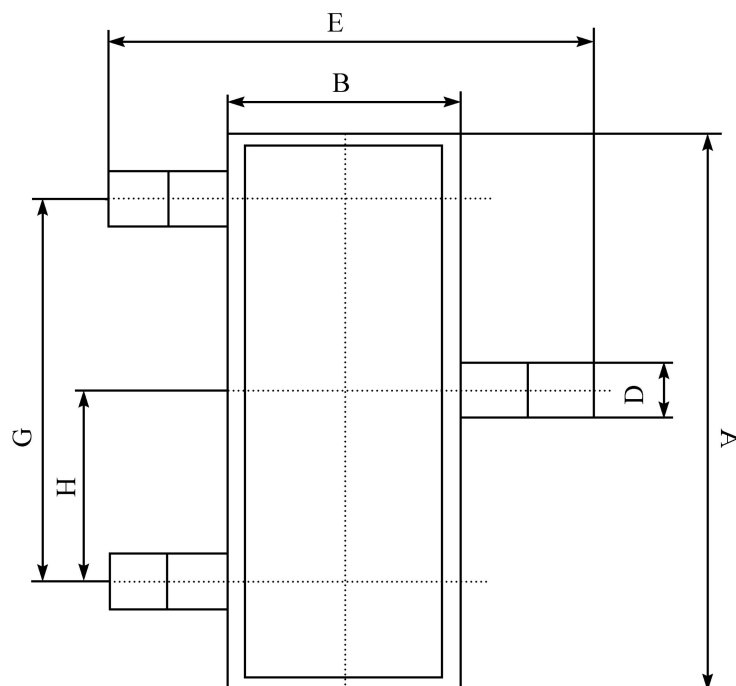

序號	數值及公差
A	2.90 ± 0.10
B	1.30 ± 0.10
C	1.00 ± 0.10
D	0.40 ± 0.10
E	2.40 ± 0.20
G	1.90 ± 0.10
H	0.95 ± 0.05
J	0.13 ± 0.05
K	$0.00 - 0.10$
M	≥ 0.2
N	0.60 ± 0.10
P	$7 \pm 2^\circ$

