

# NGRV5030UG1R575G1TRF

## 1575 MHz GNSS Vertical Chip Antenna



### Features

- Stable and reliable performance
- GNSS Vertical Antenna
- Low Profile, Compact Size
- RoHs Complaint

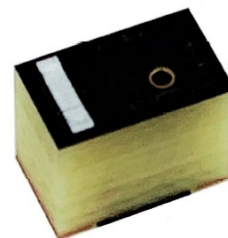

### Applications

- GNSS ( Global Navigation Satellite System)
- Handheld Devices when GPS/ bds/Glonass & Galileo functions are needed, e.g. PDA, Smart phone, PND.

### Specifications

Electrical	
Frequency Range	1560~1606MHz
Center Frequency	1575.42 MHz
Gain	1.5 dBi typ.
Efficiency	55.8% typ.
V.S.W.R	2.0 Max
Maximum Input Power	2 W
Polarization	Linear
Impedance	50Ω
Environmental	
Operating Temperature	-40°C~+85°C
Storage Temperature	-5°C~+40°C -40°C~+85°C - After mounting on PCB
Relative Humidity	10% to 70% - Operating & Storage after mounting on PCB 20% to 70% - Storage
Shelf Life	1 year
RoHs Compliant	Yes

# NGRV5030UG1R575G1TRF

1575 MHz GNSS Vertical Chip Antenna



## Part Number Breakdown

NGRV5030UG1R575G1TRF

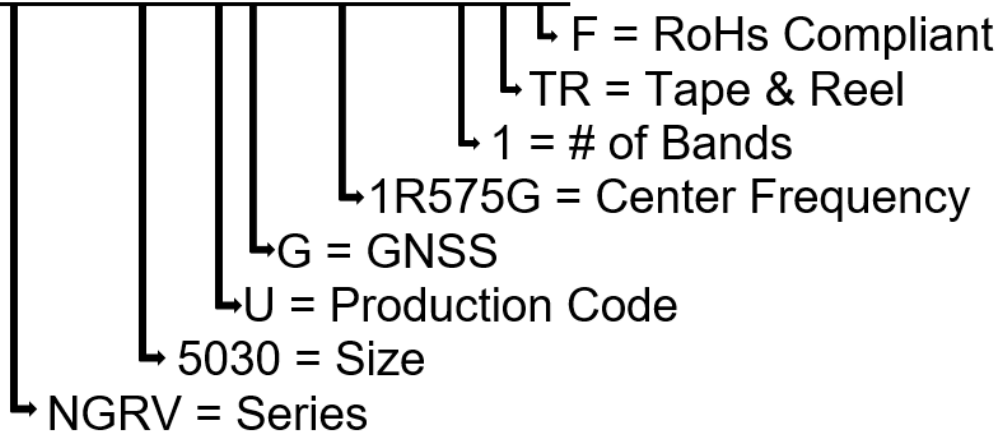

## Pin Definition

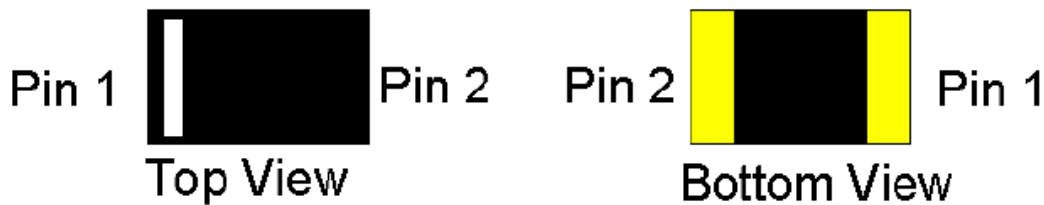

PIN	1	2
Soldering PAD	Signal	N/C

# NGRV5030UG1R575G1TRF

1575 MHz GNSS Vertical Chip Antenna



## Dimension Drawing

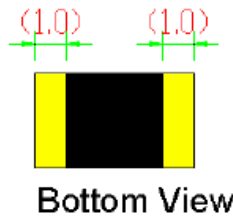
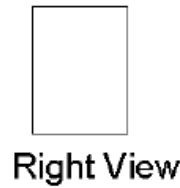
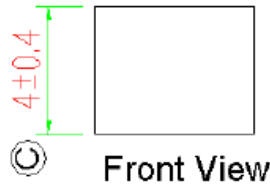
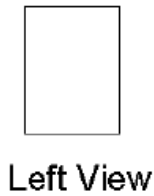
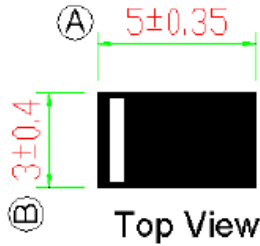

**NOTE:**  
1. All materials are RoHS 2.0 compliant.  
2. "A~C" Critical Dimensions.  
3. "( )" Reference Dimensions.

## Dimensions (mm) & Mechanical

Body Length (A)	5.0 ± 0.15
Width (B)	3.0 ± 0.15
Thickness (C)	4.0 ± 0.15
Connection Type	SMT
Ground Plane	100 mm x 50 mm
Material	FR4

# NGRV5030UG1R575G1TRF

1575 MHz GNSS Vertical Chip Antenna



## Evaluation Board

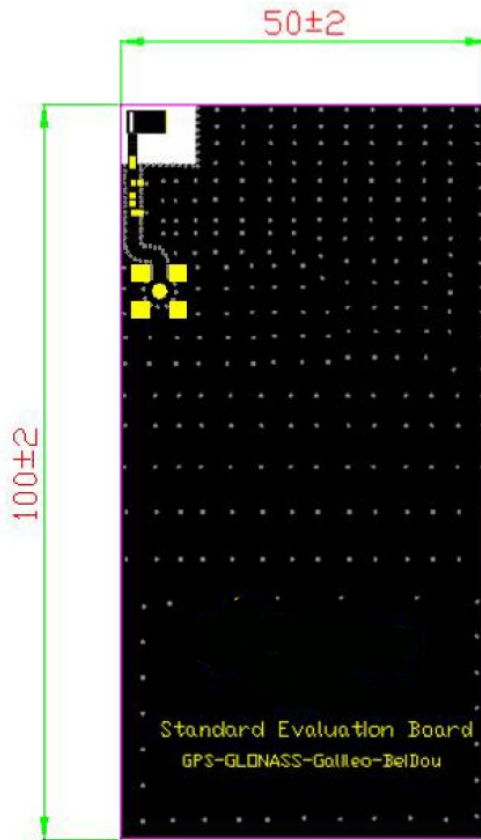

Unit: mm

## Frequency Vs VSWR and Total Radiation Gain

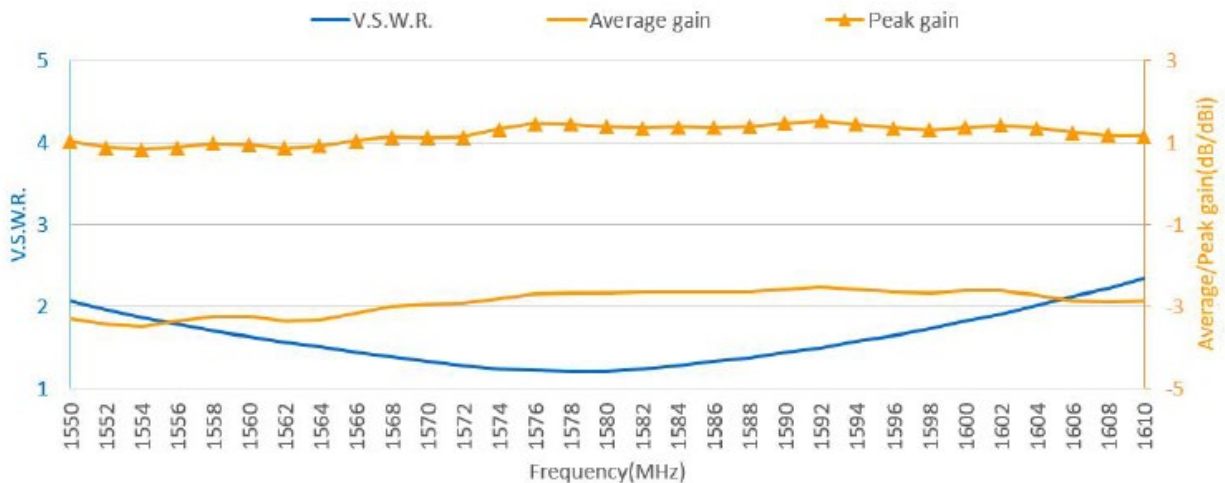

# NGRV5030UG1R575G1TRF

1575 MHz GNSS Vertical Chip Antenna



## Solder Land Pattern

The gold areas represent the solder land pattern. Any recommendations on the matching circuit will be provided according to the customer's installation conditions.

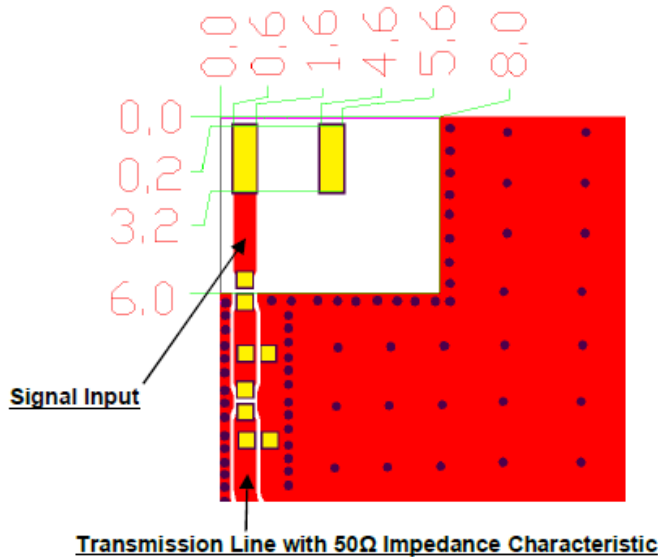

Top View

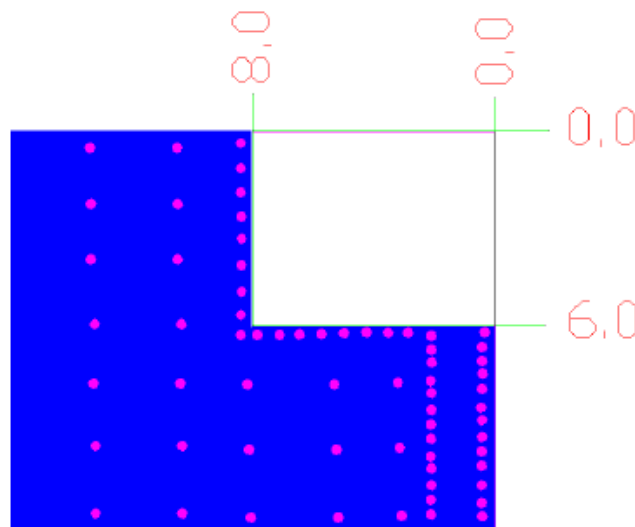

Bottom View

### Soldering Conditions

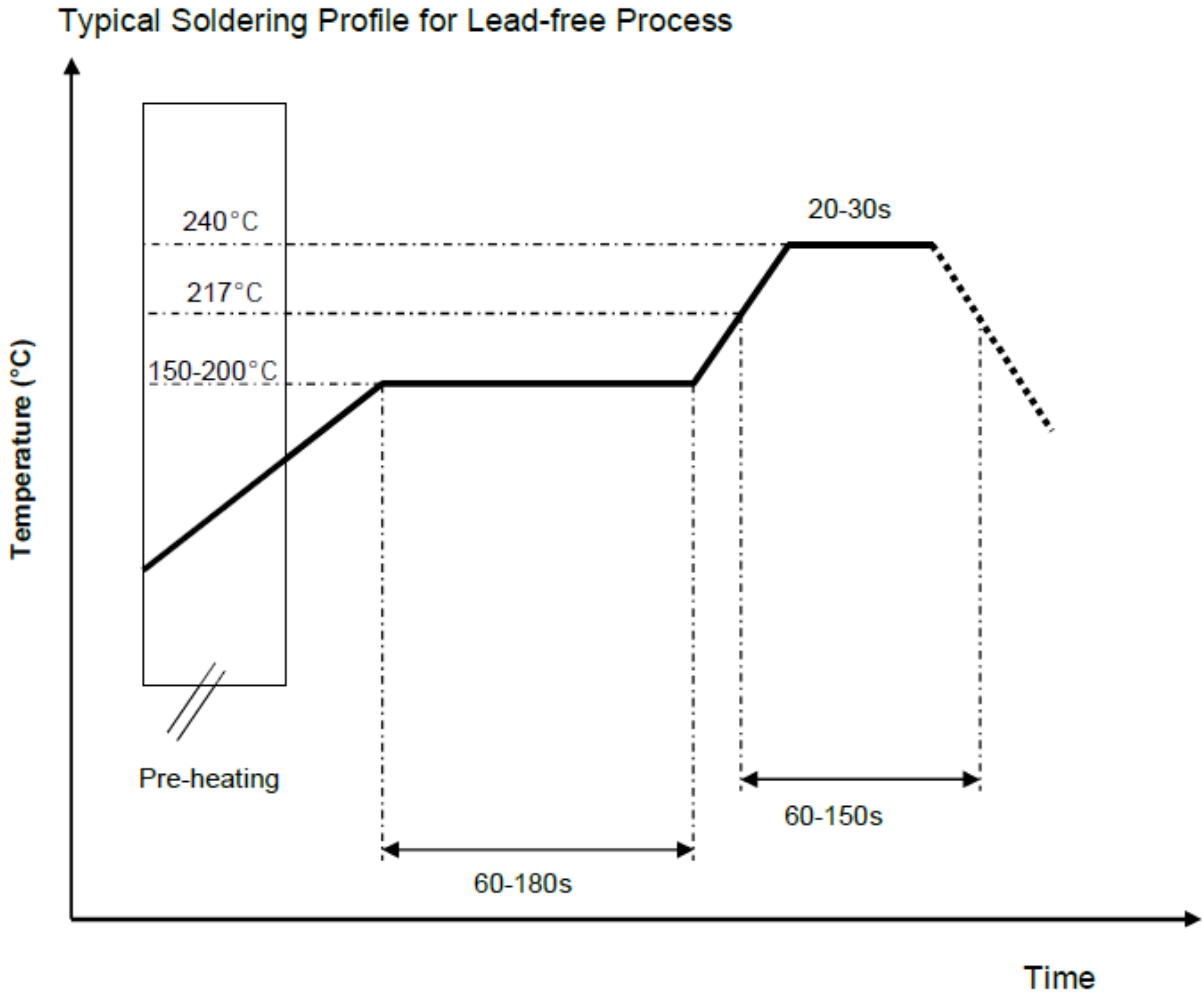

# NGRV5030UG1R575G1TRF

1575 MHz GNSS Vertical Chip Antenna



## Radiation Patterns

3D Gain Patterns @ 1575.42 MHz

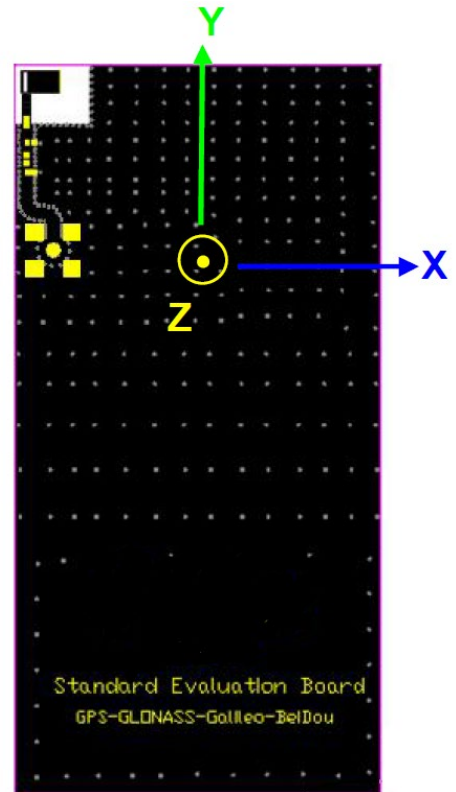
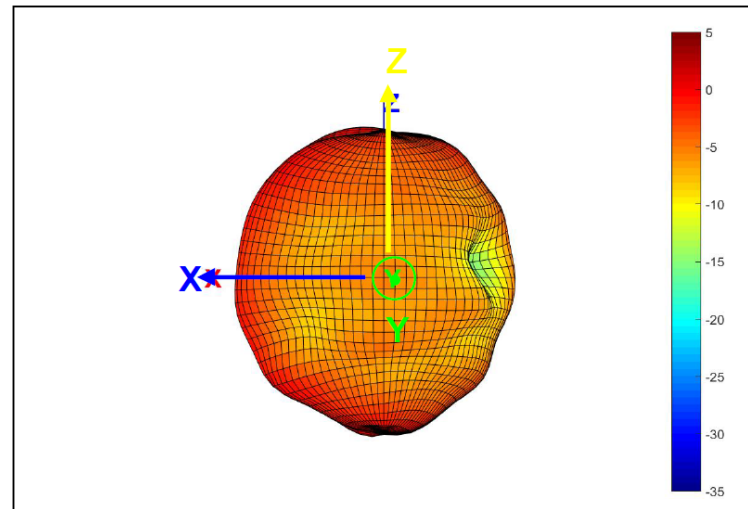
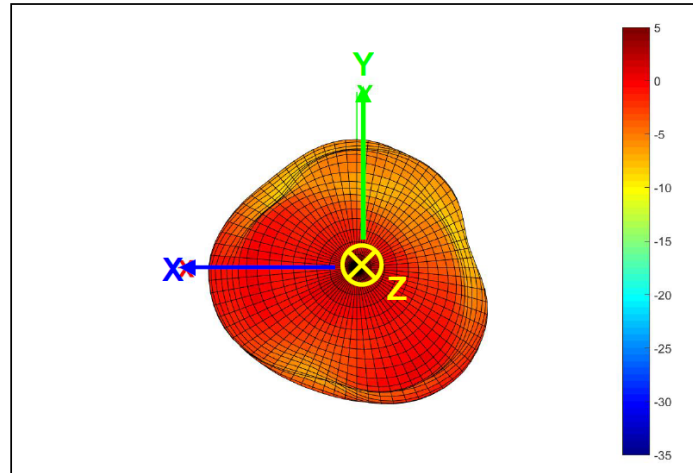
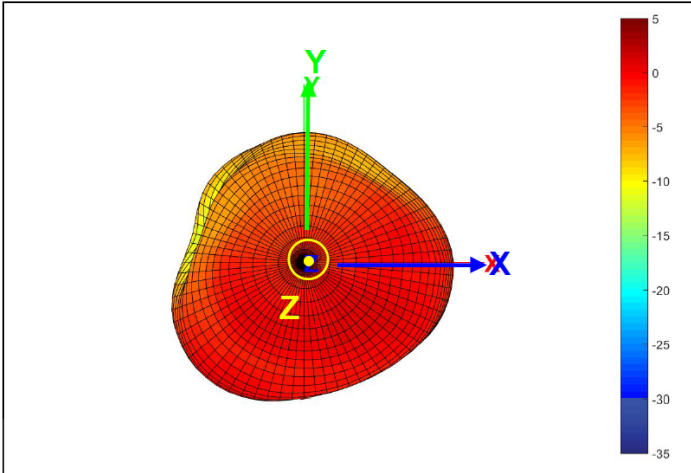

### Frequency Tuning & Matching Circuit

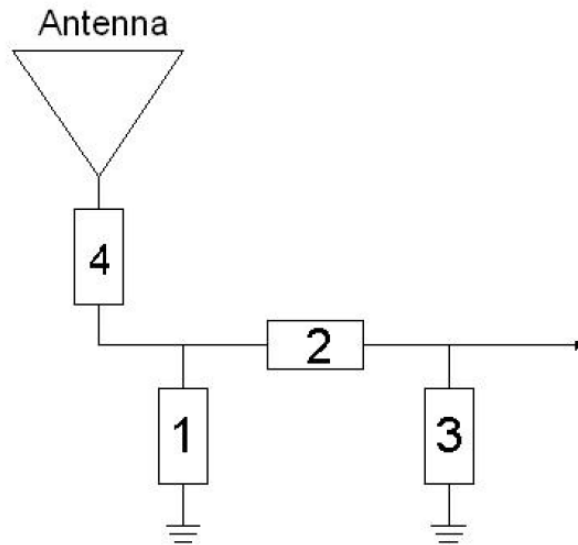
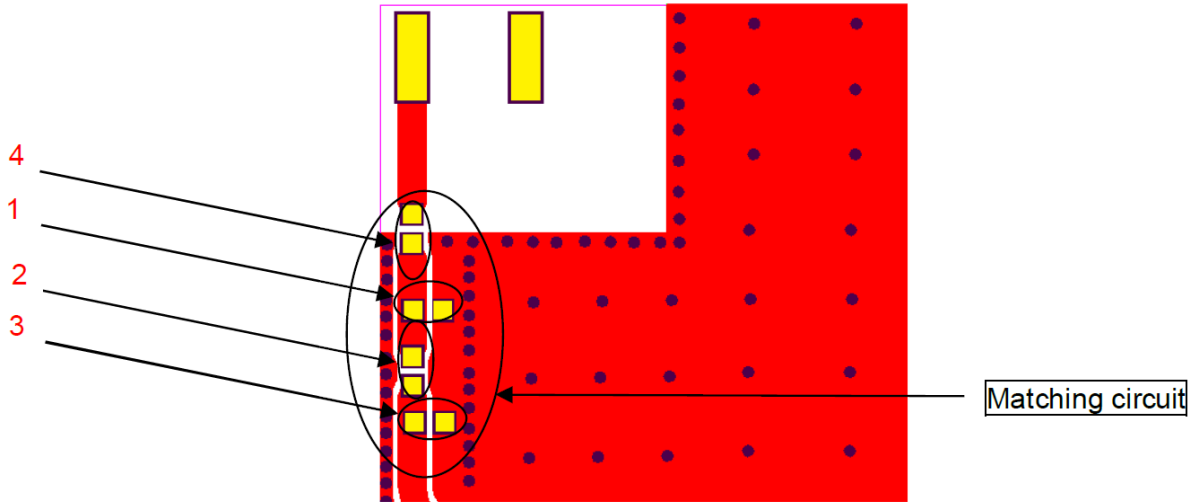



# NGRV5030UG1R575G1TRF

1575 MHz GNSS Vertical Chip Antenna



## System Matching Circuit Component

Location	Description	Tolerance	NIC Part Number
1	2.2nH, (0402)	±0.1nH	<a href="#">NML04B2N2TRF</a>
2	6.8pF, (0402)	±0.05pF	<a href="#">NMC-Q0402NPO6R8A50TRPF</a>
3	-	-	-
4	6.2nH, (0402)	±0.1 nH	<a href="#">NML04B6N2TRF</a>

# NGRV5030UG1R575G1TRF

1575 MHz GNSS Vertical Chip Antenna



## Packing

- (1) Quantity/Reel: 1500 pcs/Reel
- (2) Plastic tape

a. Tape Drawing

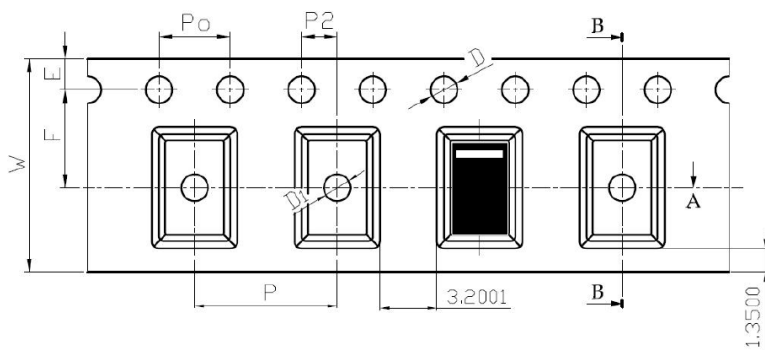

b. Tape Dimensions (unit: mm)

Feature	Specifications	Tolerances
W	12.00	±0.30
P	8.00	±0.10
E	1.75	±0.10
F	5.50	±0.10
P2	2.00	±0.10
D	1.50	+0.10 -0.00
D1	1.50	+0.10
Po	4.00	±0.10
10Po	40.00	±0.20