

CSD18542KTT 60-V N-Channel NexFET™ Power MOSFET

1 Features

- Ultra-Low Q_g and Q_{gd}
- Low-Thermal Resistance
- Avalanche Rated
- Logic Level
- Lead-Free Terminal Plating
- RoHS Compliant
- Halogen Free
- D²PAK Plastic Package

2 Applications

- DC-DC Conversion
- Secondary Side Synchronous Rectifier
- Motor Control

3 Description

This 60-V, 3.3-m Ω , D²PAK (TO-263) NexFET™ power MOSFET is designed to minimize losses in power conversion applications.

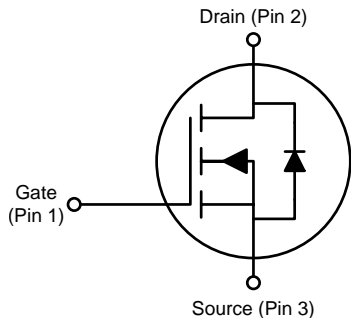

Product Summary

$T_A = 25^\circ\text{C}$		TYPICAL VALUE		UNIT
V_{DS}	Drain-to-Source Voltage	60		V
Q_g	Gate Charge Total (10 V)	44		nC
Q_{gd}	Gate Charge Gate-to-Drain	6.9		nC
$R_{DS(on)}$	Drain-to-Source On Resistance	$V_{GS} = 4.5\text{ V}$	4.0	m Ω
		$V_{GS} = 10\text{ V}$	3.3	
$V_{GS(th)}$	Threshold Voltage	1.8		V

Device Information⁽¹⁾

DEVICE	QTY	MEDIA	PACKAGE	SHIP
CSD18542KTT	500	13-Inch Reel	D ² PAK Plastic Package	Tape and Reel
CSD18542KTTT	50			

(1) For all available packages, see the orderable addendum at the end of the data sheet.

Absolute Maximum Ratings

$T_A = 25^\circ\text{C}$		VALUE	UNIT
V_{DS}	Drain-to-Source Voltage	60	V
V_{GS}	Gate-to-Source Voltage	± 20	V
I_D	Continuous Drain Current (Package Limited)	200	A
	Continuous Drain Current (Silicon Limited), $T_C = 25^\circ\text{C}$	170	
	Continuous Drain Current (Silicon Limited), $T_C = 100^\circ\text{C}$	120	
I_{DM}	Pulsed Drain Current ⁽¹⁾	400	A
P_D	Power Dissipation	250	W
T_J, T_{stg}	Operating Junction, Storage Temperature	-55 to 175	$^\circ\text{C}$
E_{AS}	Avalanche Energy, Single Pulse $I_D = 75\text{ A}, L = 0.1\text{ mH}, R_G = 25\ \Omega$	281	mJ

(1) Max $R_{\theta JC} = 0.6^\circ\text{C}/\text{W}$, pulse duration $\leq 100\ \mu\text{s}$, duty cycle $\leq 1\%$.

$R_{DS(on)}$ vs V_{GS}

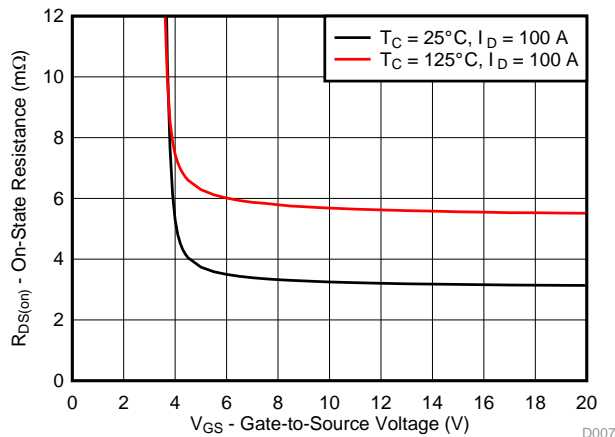

Gate Charge

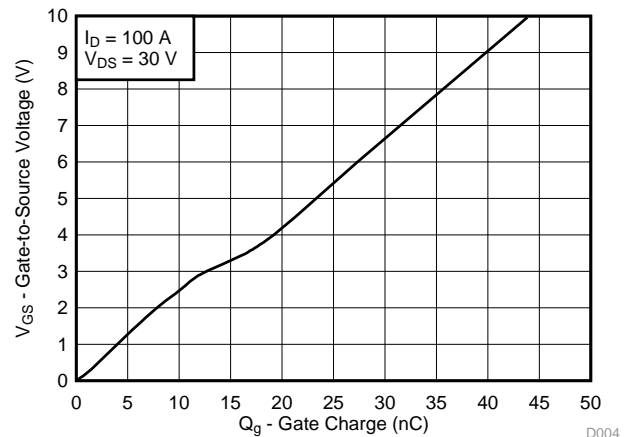

Table of Contents

1 Features	1	6.2 Community Resources.....	7
2 Applications	1	6.3 Trademarks	7
3 Description	1	6.4 Electrostatic Discharge Caution	7
4 Revision History	2	6.5 Glossary	7
5 Specifications	3	7 Mechanical, Packaging, and Orderable Information	8
5.1 Electrical Characteristics.....	3	7.1 KTT Package Dimensions	8
5.2 Thermal Information	3	7.2 Recommended PCB Pattern.....	9
5.3 Typical MOSFET Characteristics.....	4	7.3 Recommended Stencil Opening (0.125 mm Stencil Thickness).....	9
6 Device and Documentation Support	7		
6.1 Receiving Notification of Documentation Updates....	7		

4 Revision History

Changes from Original (March 2016) to Revision A

Page

- Changed the values for C_{OSS} , Q_{gs} , t_r , $t_{d(off)}$, t_f , Q_{rr} , and t_{rr} in the *Electrical Characteristics* table **3**
- Added *Receiving Notification of Documentation Updates* section to the *Device and Documentation Support* section..... **7**

5 Specifications

5.1 Electrical Characteristics

 $T_A = 25^\circ\text{C}$ (unless otherwise stated)

PARAMETER		TEST CONDITIONS	MIN	TYP	MAX	UNIT
STATIC CHARACTERISTICS						
V_{DSS}	Drain-to-source voltage	$V_{GS} = 0\text{ V}, I_D = 250\ \mu\text{A}$	60			V
I_{DSS}	Drain-to-source leakage current	$V_{GS} = 0\text{ V}, V_{DS} = 48\text{ V}$			1	μA
I_{GSS}	Gate-to-source leakage current	$V_{DS} = 0\text{ V}, V_{GS} = 20\text{ V}$			100	nA
$V_{GS(th)}$	Gate-to-source threshold voltage	$V_{DS} = V_{GS}, I_D = 250\ \mu\text{A}$	1.5	1.8	2.2	V
$R_{DS(on)}$	Drain-to-source on resistance	$V_{GS} = 4.5\text{ V}, I_D = 100\text{ A}$		4.0	5.1	m Ω
		$V_{GS} = 10\text{ V}, I_D = 100\text{ A}$		3.3	4.0	
g_{fs}	Transconductance	$V_{DS} = 6\text{ V}, I_D = 100\text{ A}$		198		S
DYNAMIC CHARACTERISTICS						
C_{iss}	Input capacitance	$V_{GS} = 0\text{ V}, V_{DS} = 30\text{ V}, f = 1\text{ MHz}$		3900	5070	pF
C_{oss}	Output capacitance			570	740	pF
C_{rss}	Reverse transfer capacitance			11	14	pF
R_G	Series gate resistance			1.3	2.6	Ω
Q_g	Gate charge total (4.5 V)	$V_{DS} = 30\text{ V}, I_D = 100\text{ A}$		21	27	nC
Q_g	Gate charge total (10 V)			44	57	nC
Q_{gd}	Gate charge gate-to-drain			6.9		nC
Q_{gs}	Gate charge gate-to-source			10		nC
$Q_{g(th)}$	Gate charge at V_{th}			7.3		nC
Q_{oss}	Output charge		$V_{DS} = 30\text{ V}, V_{GS} = 0\text{ V}$		63	
$t_{d(on)}$	Turnon delay time	$V_{DS} = 30\text{ V}, V_{GS} = 10\text{ V}, I_{DS} = 100\text{ A}, R_G = 0\ \Omega$		6		ns
t_r	Rise time			5		ns
$t_{d(off)}$	Turnoff delay time			18		ns
t_f	Fall time			21		ns
DIODE CHARACTERISTICS						
V_{SD}	Diode forward voltage	$I_{SD} = 100\text{ A}, V_{GS} = 0\text{ V}$		0.9	1.0	V
Q_{rr}	Reverse recovery charge	$V_{DS} = 30\text{ V}, I_F = 100\text{ A}, di/dt = 300\text{ A}/\mu\text{s}$		148		nC
t_{rr}	Reverse recovery time			53		ns

5.2 Thermal Information

 $T_A = 25^\circ\text{C}$ (unless otherwise stated)

THERMAL METRIC		MIN	TYP	MAX	UNIT
$R_{\theta JC}$	Junction-to-case thermal resistance			0.6	$^\circ\text{C}/\text{W}$
$R_{\theta JA}$	Junction-to-ambient thermal resistance			62	$^\circ\text{C}/\text{W}$

5.3 Typical MOSFET Characteristics

T_A = 25°C (unless otherwise stated)

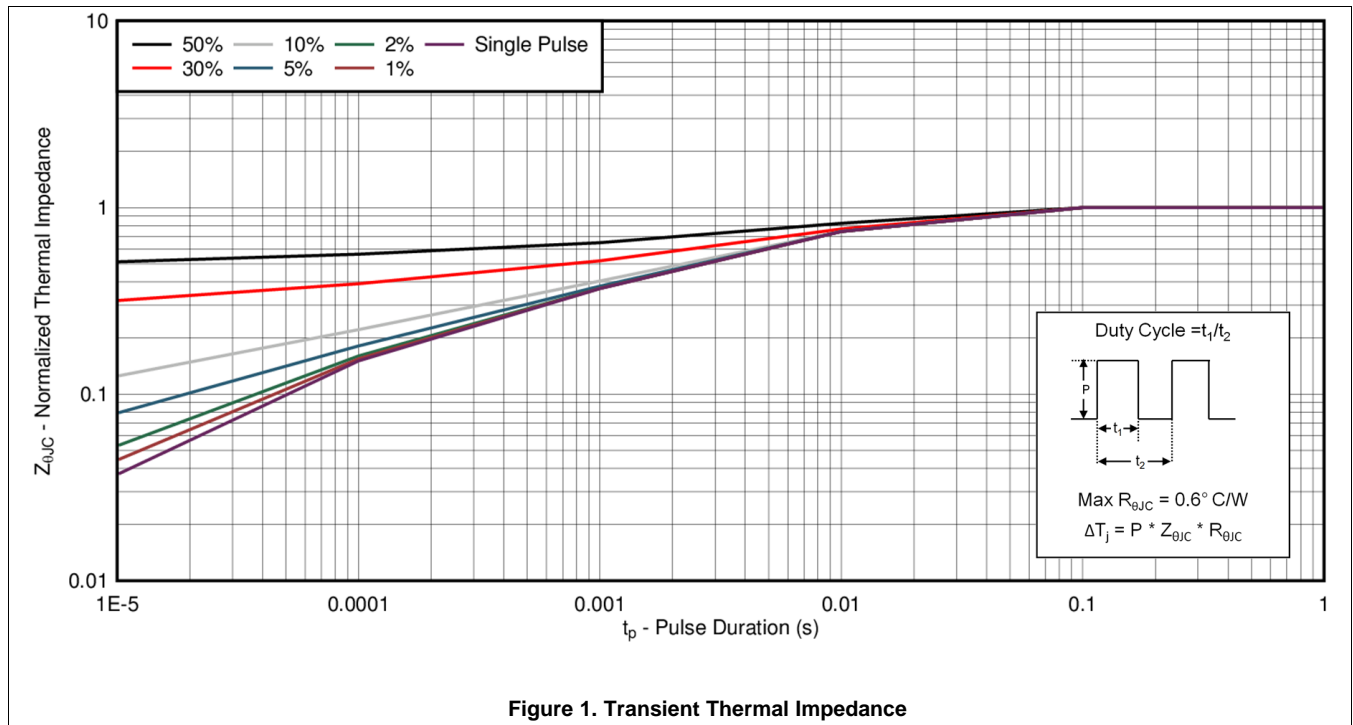

Figure 1. Transient Thermal Impedance

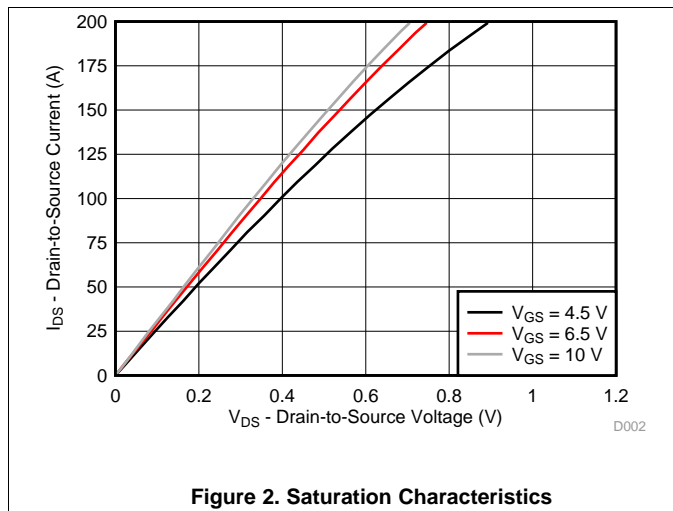

Figure 2. Saturation Characteristics

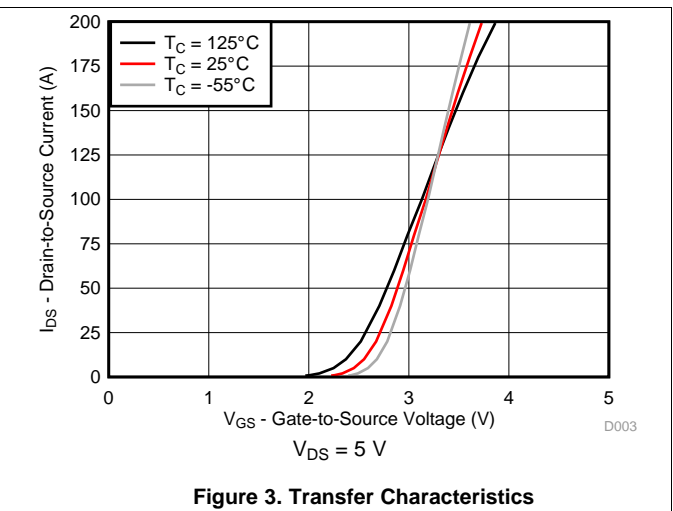
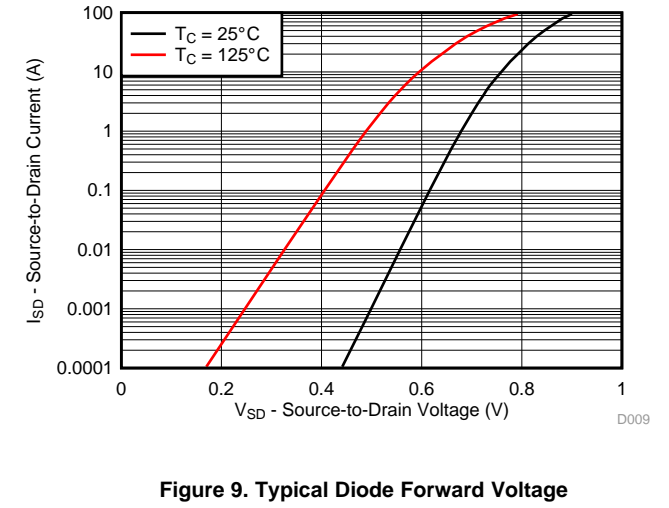
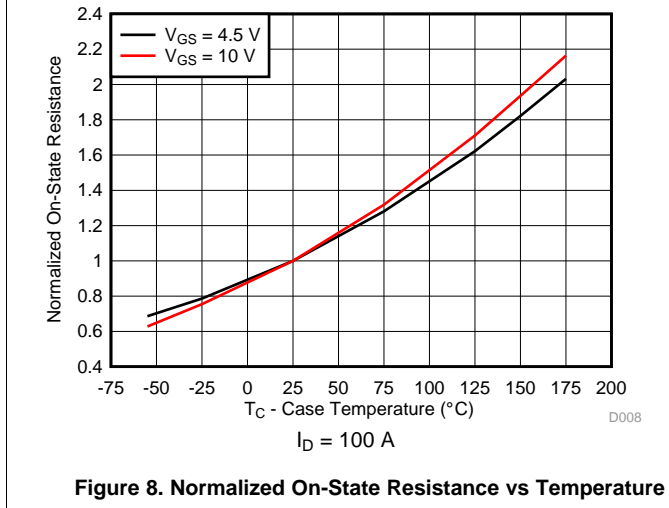
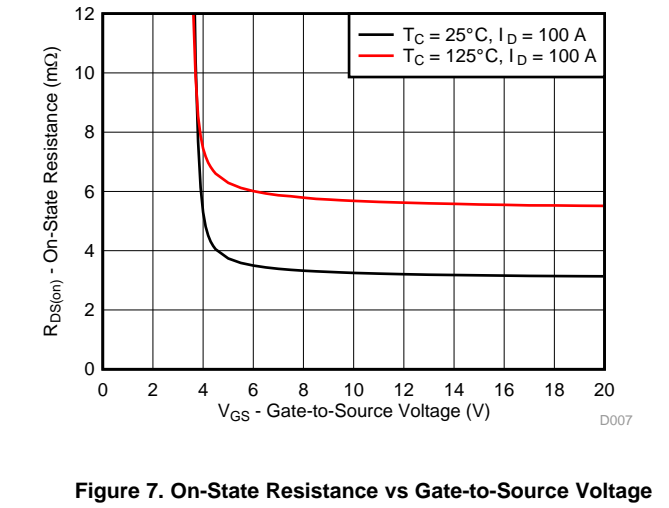
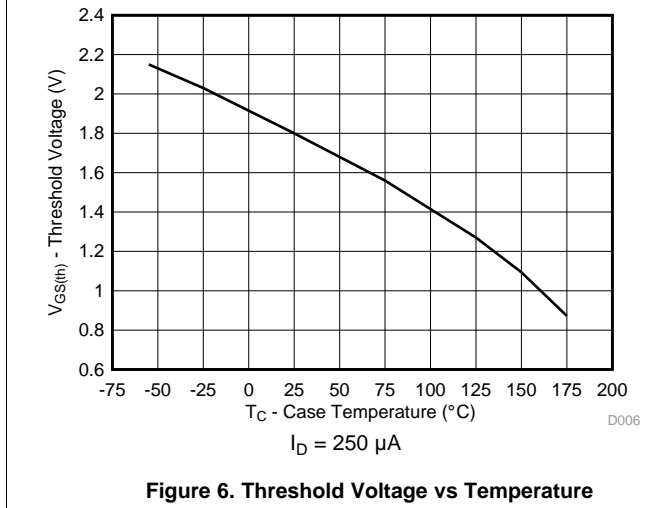
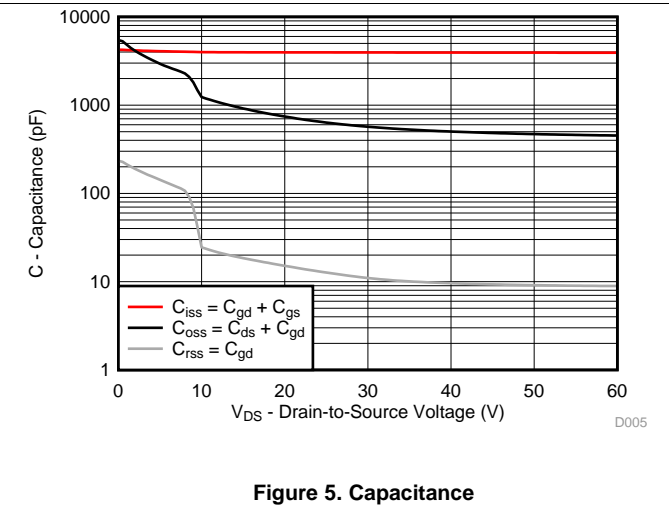
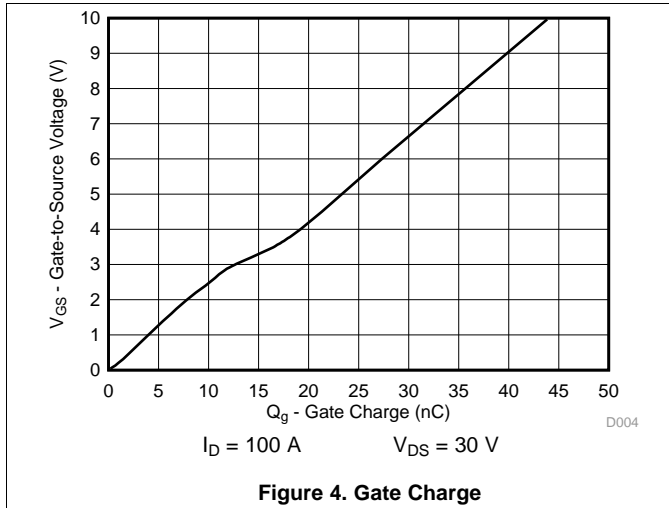

Figure 3. Transfer Characteristics

Typical MOSFET Characteristics (continued)

T_A = 25°C (unless otherwise stated)



Typical MOSFET Characteristics (continued)

$T_A = 25^\circ\text{C}$ (unless otherwise stated)

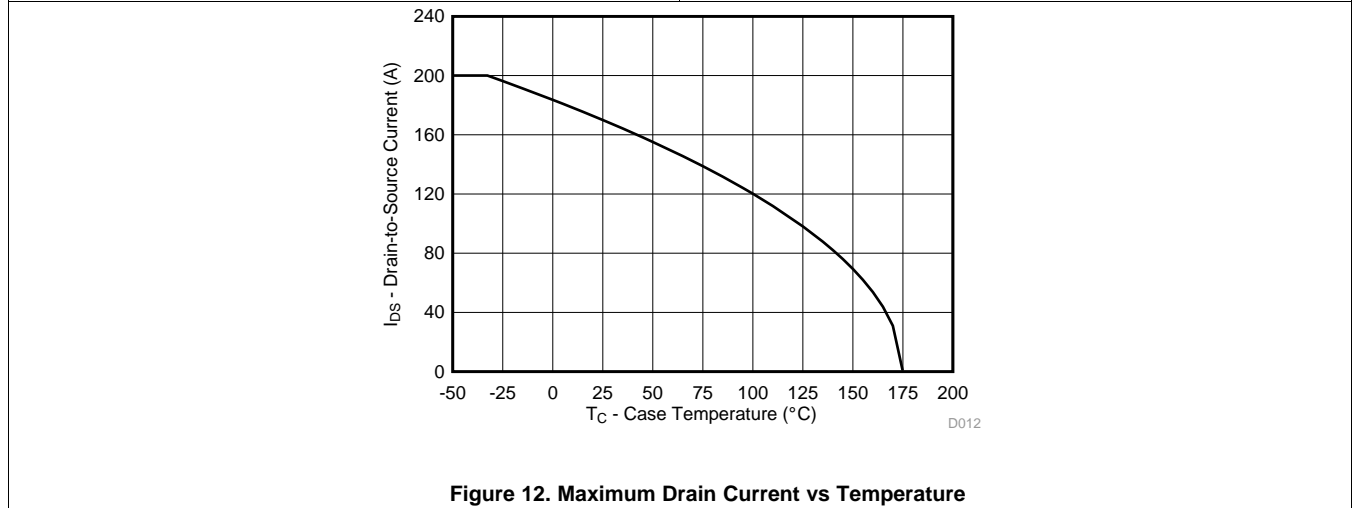
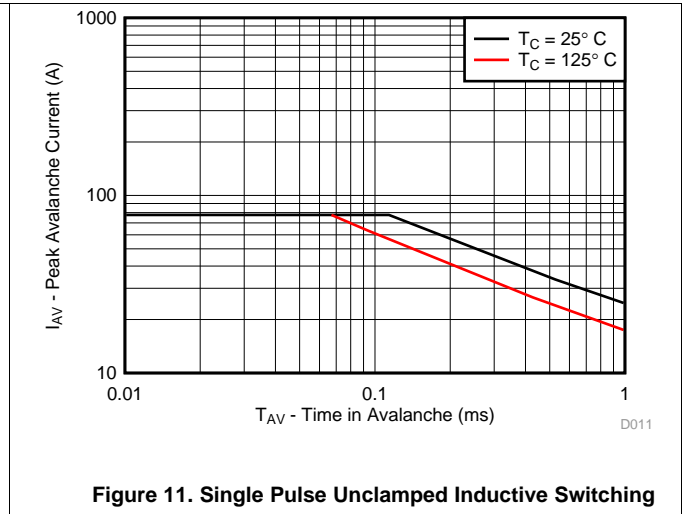
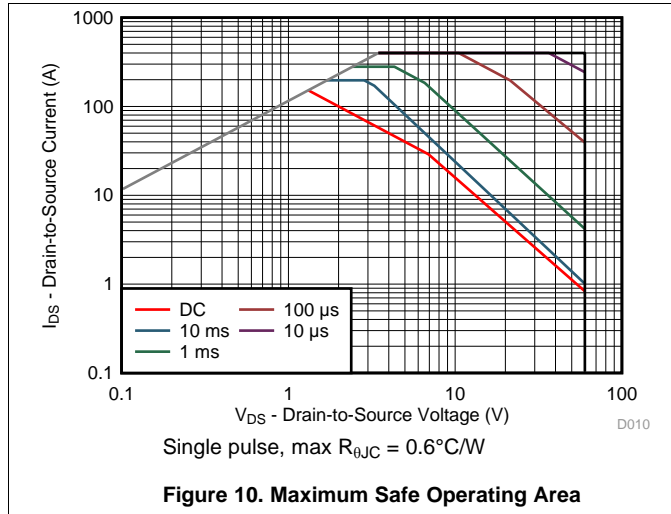

6 Device and Documentation Support

6.1 Receiving Notification of Documentation Updates

To receive notification of documentation updates, navigate to the device product folder on ti.com. In the upper right corner, click on *Alert me* to register and receive a weekly digest of any product information that has changed. For change details, review the revision history included in any revised document.

6.2 Community Resources

The following links connect to TI community resources. Linked contents are provided "AS IS" by the respective contributors. They do not constitute TI specifications and do not necessarily reflect TI's views; see TI's [Terms of Use](#).

TI E2E™ Online Community *TI's Engineer-to-Engineer (E2E) Community*. Created to foster collaboration among engineers. At e2e.ti.com, you can ask questions, share knowledge, explore ideas and help solve problems with fellow engineers.

Design Support *TI's Design Support* Quickly find helpful E2E forums along with design support tools and contact information for technical support.

6.3 Trademarks

NexFET, E2E are trademarks of Texas Instruments.
All other trademarks are the property of their respective owners.

6.4 Electrostatic Discharge Caution



These devices have limited built-in ESD protection. The leads should be shorted together or the device placed in conductive foam during storage or handling to prevent electrostatic damage to the MOS gates.

6.5 Glossary

[SLYZ022](#) — *TI Glossary*.

This glossary lists and explains terms, acronyms, and definitions.

7 Mechanical, Packaging, and Orderable Information

The following pages include mechanical, packaging, and orderable information. This information is the most current data available for the designated devices. This data is subject to change without notice and revision of this document. For browser-based versions of this data sheet, refer to the left-hand navigation.

7.1 KTT Package Dimensions

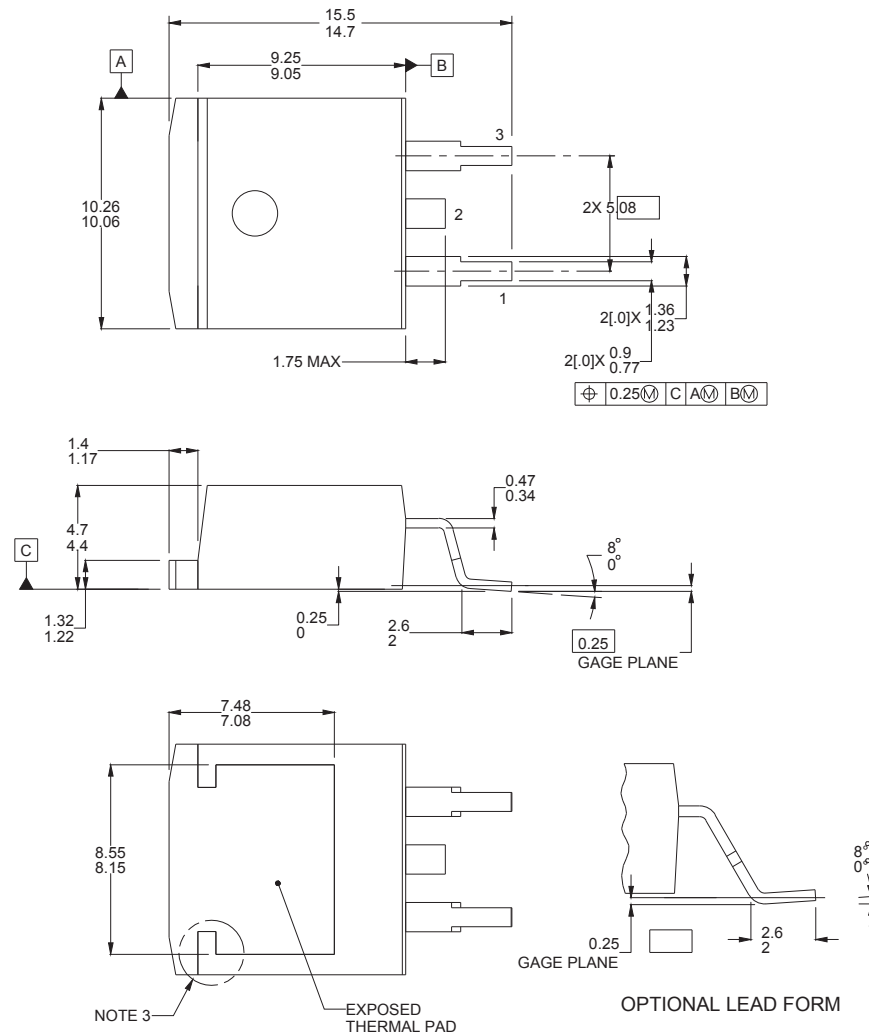

Notes:

1. All linear dimensions are in millimeters. Any dimensions in parenthesis are for reference only. Dimensioning and tolerancing per ASME Y14.5M.
2. This drawing is subject to change without notice.
3. Features may not exist and shape may vary per different assembly sites.

Table 1. Pin Configuration

POSITION	DESIGNATION
Pin 1	Gate
Pin 2 / Tab	Drain
Pin 3	Source

7.2 Recommended PCB Pattern

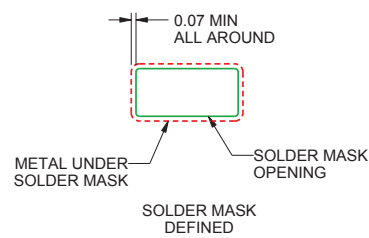
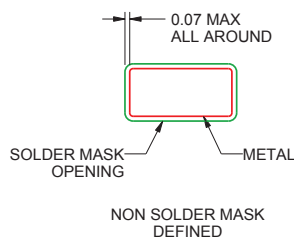
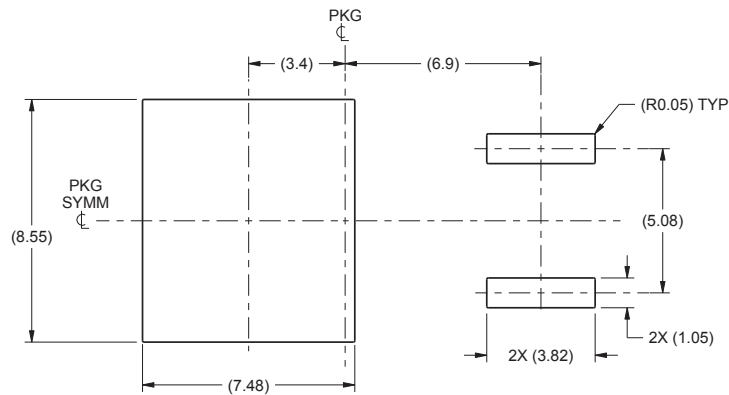

For recommended circuit layout for PCB designs, see [Reducing Ringing Through PCB Layout Techniques \(SLPA005\)](#).

7.3 Recommended Stencil Opening (0.125 mm Stencil Thickness)

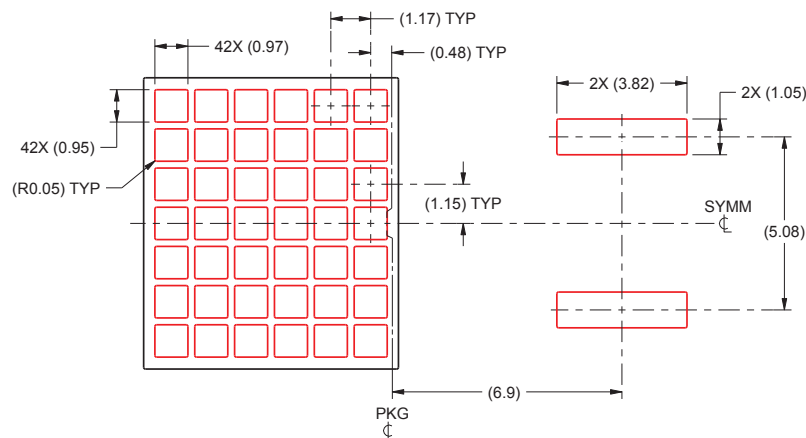

Notes:

1. This package is designed to be soldered to a thermal pad on the board. See application notes [PowerPAD Thermally Enhanced Package \(SLMA002\)](#) and [PowerPAD Made Easy \(SLMA004\)](#) for more information.
2. Laser cutting apertures with trapezoidal walls and rounded corners may offer better paste release. IPC-7525 may have alternate design recommendations.
3. Board assembly site may have different recommendations for stencil design.

PACKAGING INFORMATION

Orderable Device	Status (1)	Package Type	Package Drawing	Pins	Package Qty	Eco Plan (2)	Lead/Ball Finish (6)	MSL Peak Temp (3)	Op Temp (°C)	Device Marking (4/5)	Samples
CSD18542KTT	ACTIVE	DDPAK/ TO-263	KTT	3	500	Pb-Free (RoHS Exempt)	CU SN	Level-2-260C-1 YEAR	-55 to 175	CSD18542KTT	Samples
CSD18542KTTT	ACTIVE	DDPAK/ TO-263	KTT	3	50	Pb-Free (RoHS Exempt)	CU SN	Level-2-260C-1 YEAR	-55 to 175	CSD18542KTT	Samples

(1) The marketing status values are defined as follows:

ACTIVE: Product device recommended for new designs.

LIFEBUY: TI has announced that the device will be discontinued, and a lifetime-buy period is in effect.

NRND: Not recommended for new designs. Device is in production to support existing customers, but TI does not recommend using this part in a new design.

PREVIEW: Device has been announced but is not in production. Samples may or may not be available.

OBSOLETE: TI has discontinued the production of the device.

(2) Eco Plan - The planned eco-friendly classification: Pb-Free (RoHS), Pb-Free (RoHS Exempt), or Green (RoHS & no Sb/Br) - please check <http://www.ti.com/productcontent> for the latest availability information and additional product content details.

TBD: The Pb-Free/Green conversion plan has not been defined.

Pb-Free (RoHS): TI's terms "Lead-Free" or "Pb-Free" mean semiconductor products that are compatible with the current RoHS requirements for all 6 substances, including the requirement that lead not exceed 0.1% by weight in homogeneous materials. Where designed to be soldered at high temperatures, TI Pb-Free products are suitable for use in specified lead-free processes.

Pb-Free (RoHS Exempt): This component has a RoHS exemption for either 1) lead-based flip-chip solder bumps used between the die and package, or 2) lead-based die adhesive used between the die and leadframe. The component is otherwise considered Pb-Free (RoHS compatible) as defined above.

Green (RoHS & no Sb/Br): TI defines "Green" to mean Pb-Free (RoHS compatible), and free of Bromine (Br) and Antimony (Sb) based flame retardants (Br or Sb do not exceed 0.1% by weight in homogeneous material)

(3) MSL, Peak Temp. - The Moisture Sensitivity Level rating according to the JEDEC industry standard classifications, and peak solder temperature.

(4) There may be additional marking, which relates to the logo, the lot trace code information, or the environmental category on the device.

(5) Multiple Device Markings will be inside parentheses. Only one Device Marking contained in parentheses and separated by a "~" will appear on a device. If a line is indented then it is a continuation of the previous line and the two combined represent the entire Device Marking for that device.

(6) Lead/Ball Finish - Orderable Devices may have multiple material finish options. Finish options are separated by a vertical ruled line. Lead/Ball Finish values may wrap to two lines if the finish value exceeds the maximum column width.

Important Information and Disclaimer: The information provided on this page represents TI's knowledge and belief as of the date that it is provided. TI bases its knowledge and belief on information provided by third parties, and makes no representation or warranty as to the accuracy of such information. Efforts are underway to better integrate information from third parties. TI has taken and continues to take reasonable steps to provide representative and accurate information but may not have conducted destructive testing or chemical analysis on incoming materials and chemicals. TI and TI suppliers consider certain information to be proprietary, and thus CAS numbers and other limited information may not be available for release.

In no event shall TI's liability arising out of such information exceed the total purchase price of the TI part(s) at issue in this document sold by TI to Customer on an annual basis.

KTT (R-PSFM-G3)

PLASTIC FLANGE-MOUNT PACKAGE

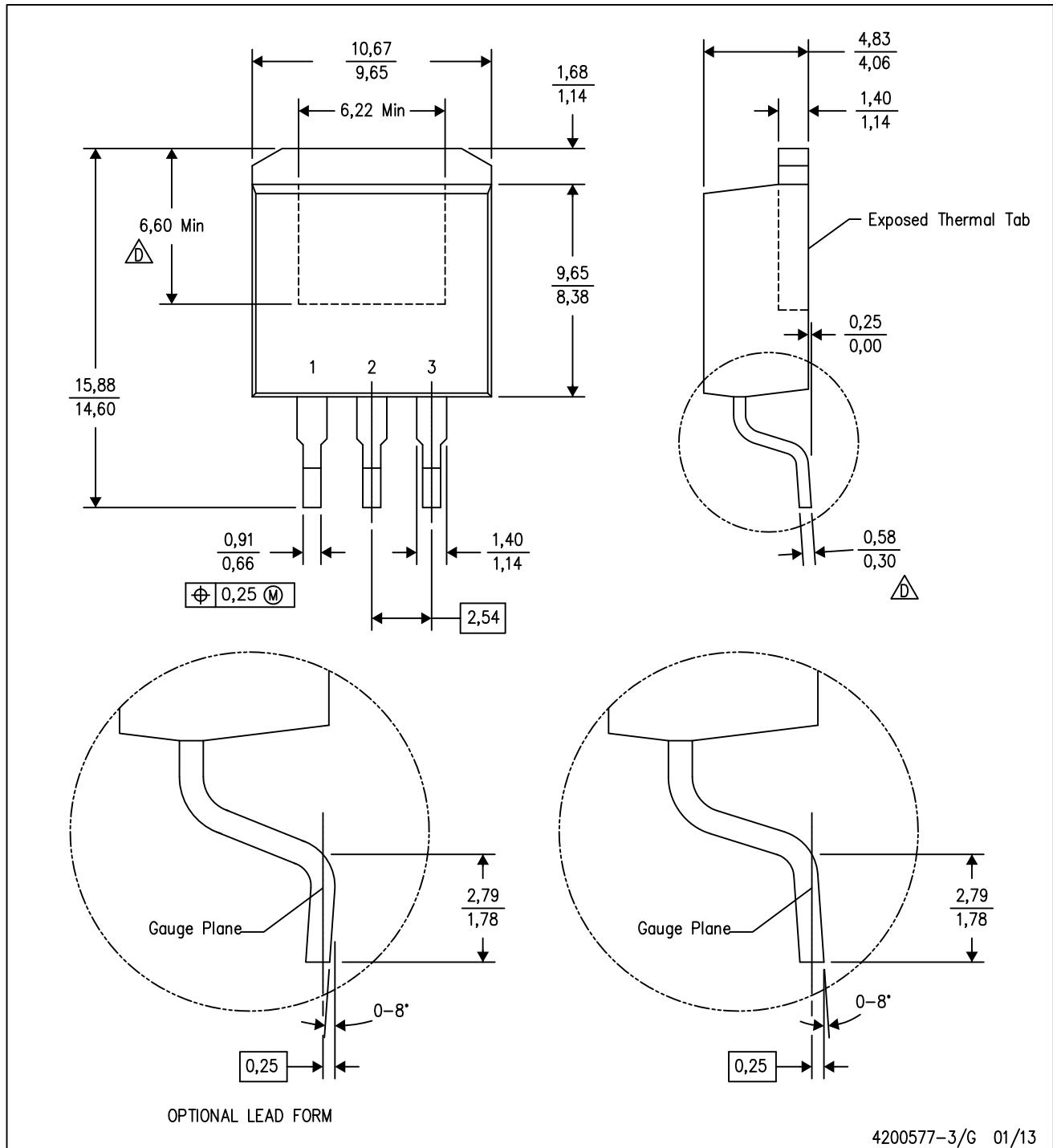

- NOTES:
- A. All linear dimensions are in millimeters.
 - B. This drawing is subject to change without notice.
 - C. Body dimensions do not include mold flash or protrusion. Mold flash or protrusion not to exceed 0.005 (0,13) per side.
- Falls within JEDEC TO-263 variation AA, except minimum lead thickness and minimum exposed pad length.

IMPORTANT NOTICE

Texas Instruments Incorporated (TI) reserves the right to make corrections, enhancements, improvements and other changes to its semiconductor products and services per JESD46, latest issue, and to discontinue any product or service per JESD48, latest issue. Buyers should obtain the latest relevant information before placing orders and should verify that such information is current and complete.

TI's published terms of sale for semiconductor products (<http://www.ti.com/sc/docs/stdterms.htm>) apply to the sale of packaged integrated circuit products that TI has qualified and released to market. Additional terms may apply to the use or sale of other types of TI products and services.

Reproduction of significant portions of TI information in TI data sheets is permissible only if reproduction is without alteration and is accompanied by all associated warranties, conditions, limitations, and notices. TI is not responsible or liable for such reproduced documentation. Information of third parties may be subject to additional restrictions. Resale of TI products or services with statements different from or beyond the parameters stated by TI for that product or service voids all express and any implied warranties for the associated TI product or service and is an unfair and deceptive business practice. TI is not responsible or liable for any such statements.

Buyers and others who are developing systems that incorporate TI products (collectively, "Designers") understand and agree that Designers remain responsible for using their independent analysis, evaluation and judgment in designing their applications and that Designers have full and exclusive responsibility to assure the safety of Designers' applications and compliance of their applications (and of all TI products used in or for Designers' applications) with all applicable regulations, laws and other applicable requirements. Designer represents that, with respect to their applications, Designer has all the necessary expertise to create and implement safeguards that (1) anticipate dangerous consequences of failures, (2) monitor failures and their consequences, and (3) lessen the likelihood of failures that might cause harm and take appropriate actions. Designer agrees that prior to using or distributing any applications that include TI products, Designer will thoroughly test such applications and the functionality of such TI products as used in such applications.

TI's provision of technical, application or other design advice, quality characterization, reliability data or other services or information, including, but not limited to, reference designs and materials relating to evaluation modules, (collectively, "TI Resources") are intended to assist designers who are developing applications that incorporate TI products; by downloading, accessing or using TI Resources in any way, Designer (individually or, if Designer is acting on behalf of a company, Designer's company) agrees to use any particular TI Resource solely for this purpose and subject to the terms of this Notice.

TI's provision of TI Resources does not expand or otherwise alter TI's applicable published warranties or warranty disclaimers for TI products, and no additional obligations or liabilities arise from TI providing such TI Resources. TI reserves the right to make corrections, enhancements, improvements and other changes to its TI Resources. TI has not conducted any testing other than that specifically described in the published documentation for a particular TI Resource.

Designer is authorized to use, copy and modify any individual TI Resource only in connection with the development of applications that include the TI product(s) identified in such TI Resource. NO OTHER LICENSE, EXPRESS OR IMPLIED, BY ESTOPPEL OR OTHERWISE TO ANY OTHER TI INTELLECTUAL PROPERTY RIGHT, AND NO LICENSE TO ANY TECHNOLOGY OR INTELLECTUAL PROPERTY RIGHT OF TI OR ANY THIRD PARTY IS GRANTED HEREIN, including but not limited to any patent right, copyright, mask work right, or other intellectual property right relating to any combination, machine, or process in which TI products or services are used. Information regarding or referencing third-party products or services does not constitute a license to use such products or services, or a warranty or endorsement thereof. Use of TI Resources may require a license from a third party under the patents or other intellectual property of the third party, or a license from TI under the patents or other intellectual property of TI.

TI RESOURCES ARE PROVIDED "AS IS" AND WITH ALL FAULTS. TI DISCLAIMS ALL OTHER WARRANTIES OR REPRESENTATIONS, EXPRESS OR IMPLIED, REGARDING RESOURCES OR USE THEREOF, INCLUDING BUT NOT LIMITED TO ACCURACY OR COMPLETENESS, TITLE, ANY EPIDEMIC FAILURE WARRANTY AND ANY IMPLIED WARRANTIES OF MERCHANTABILITY, FITNESS FOR A PARTICULAR PURPOSE, AND NON-INFRINGEMENT OF ANY THIRD PARTY INTELLECTUAL PROPERTY RIGHTS. TI SHALL NOT BE LIABLE FOR AND SHALL NOT DEFEND OR INDEMNIFY DESIGNER AGAINST ANY CLAIM, INCLUDING BUT NOT LIMITED TO ANY INFRINGEMENT CLAIM THAT RELATES TO OR IS BASED ON ANY COMBINATION OF PRODUCTS EVEN IF DESCRIBED IN TI RESOURCES OR OTHERWISE. IN NO EVENT SHALL TI BE LIABLE FOR ANY ACTUAL, DIRECT, SPECIAL, COLLATERAL, INDIRECT, PUNITIVE, INCIDENTAL, CONSEQUENTIAL OR EXEMPLARY DAMAGES IN CONNECTION WITH OR ARISING OUT OF TI RESOURCES OR USE THEREOF, AND REGARDLESS OF WHETHER TI HAS BEEN ADVISED OF THE POSSIBILITY OF SUCH DAMAGES.

Unless TI has explicitly designated an individual product as meeting the requirements of a particular industry standard (e.g., ISO/TS 16949 and ISO 26262), TI is not responsible for any failure to meet such industry standard requirements.

Where TI specifically promotes products as facilitating functional safety or as compliant with industry functional safety standards, such products are intended to help enable customers to design and create their own applications that meet applicable functional safety standards and requirements. Using products in an application does not by itself establish any safety features in the application. Designers must ensure compliance with safety-related requirements and standards applicable to their applications. Designer may not use any TI products in life-critical medical equipment unless authorized officers of the parties have executed a special contract specifically governing such use. Life-critical medical equipment is medical equipment where failure of such equipment would cause serious bodily injury or death (e.g., life support, pacemakers, defibrillators, heart pumps, neurostimulators, and implantables). Such equipment includes, without limitation, all medical devices identified by the U.S. Food and Drug Administration as Class III devices and equivalent classifications outside the U.S.

TI may expressly designate certain products as completing a particular qualification (e.g., Q100, Military Grade, or Enhanced Product). Designers agree that it has the necessary expertise to select the product with the appropriate qualification designation for their applications and that proper product selection is at Designers' own risk. Designers are solely responsible for compliance with all legal and regulatory requirements in connection with such selection.

Designer will fully indemnify TI and its representatives against any damages, costs, losses, and/or liabilities arising out of Designer's non-compliance with the terms and provisions of this Notice.