

IGS236

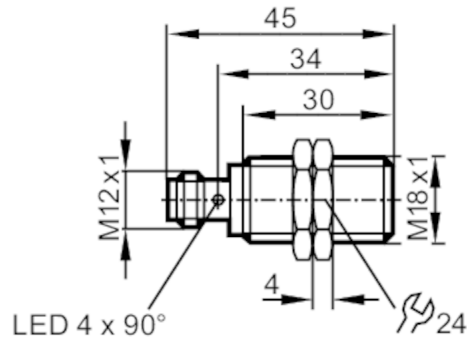

Inductive sensor

IGB3008BBPKG/US-104



Product characteristics

Electrical design	PNP
Output function	normally open
Sensing range [mm]	8
Housing	threaded type
Dimensions [mm]	M18 x 1 / L = 45

Application

Special feature	Gold-plated contacts; Increased sensing range
Application	Suitable for industrial, mobile, cooling and lubricating applications; Industrial applications / factory automation

Electrical data

Operating voltage [V]	10...30 DC
Current consumption [mA]	< 10
Protection class	III
Reverse polarity protection	yes

Outputs

Electrical design	PNP
Output function	normally open
Max. voltage drop switching output DC [V]	2.5
Permanent current rating of switching output DC [mA]	100
Switching frequency DC [Hz]	400
Short-circuit protection	yes
Overload protection	yes

Detection zone

Sensing range [mm]	8
Real sensing range Sr [mm]	8 ± 10 %
Operating distance [mm]	0...6.48
Increased sensing range	yes

Accuracy / deviations

Correction factor	steel: 1 / stainless steel: 0.7 / brass: 0.5 / aluminium: 0.4 / copper: 0.3
-------------------	---

IGS236



Inductive sensor

IGB3008BBPKG/US-104

Hysteresis	[% of Sr]	3...15
Switch point drift	[% of Sr]	-10...10

Operating conditions

Ambient temperature	[°C]	-40...85
Protection		IP 65; IP 66; IP 67; IP 68; IP 69K

Tests / approvals

EMC	EN 61000-4-2 ESD	4 kV CD / 8 kV AD
	EN 61000-4-3 HF radiated	10 V/m
	EN 61000-4-4 Burst	2 kV
	EN 61000-4-6 HF conducted	10 V
	EN 55011	class B
Vibration resistance	EN 60068-2-6 Fc	20 g (10...3000 Hz) / 50 sweep cycles, 1 octave per minute, in 3 axes
Shock resistance	EN 60068-2-27 Ea	100 g 11 ms half-sine; 3 shocks each in every direction of the 3 coordinate axes
Continuous shock resistance	EN 60068-2-27	40 g 6 ms; 4000 shocks each in every direction of the 3 coordinate axes
Fast temperature change	EN 60068-2-14 Na	TA = -40 °C; TB = 85 °C; t1 = 30 min; t2 = < 10 s; 50 cycles
Salt spray test	EN 60068-2-52 Kb	severity level 5 (4 test cycles)
MTTF	[years]	1134
Embedded software included		yes
UL approval	Ta	-25...70 °C
	Enclosure type	Type 1
	power supply	Limited Voltage/Current
	UL Approval no.	A001
	File number UL	E174191

Mechanical data

Weight	[g]	42.2
Housing		threaded type
Mounting		flush mountable
Dimensions	[mm]	M18 x 1 / L = 45
Thread designation		M18 x 1
Materials		brass white bronze coated; sensing face: PBT orange; LED window: PEI; lock nuts: brass white bronze coated

Displays / operating elements

Display	switching status	4 x LED, yellow
---------	------------------	-----------------

Accessories

Items supplied		lock nuts: 2
----------------	--	--------------

Remarks

Pack quantity		1 pcs.
---------------	--	--------

IGS236



Inductive sensor

IGB3008BBPKG/US-104

Electrical connection - plug

Connector: 1 x M12; coding: A; Contacts: gold-plated

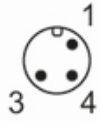

Connection

