

CGHV1J006D

6 W, 18.0 GHz, GaN HEMT Die

Description

The CGHV1J006D is a high voltage gallium nitride (GaN) High Electron Mobility Transistor (HEMT) on a silicon carbide substrate, using a 0.25 μm gate length fabrication process. This GaN-on-SiC product offers superior high frequency, high efficiency features. It is ideal for a variety of applications operating from 10 MHz to 18 GHz at 40 V with a high breakdown voltage.

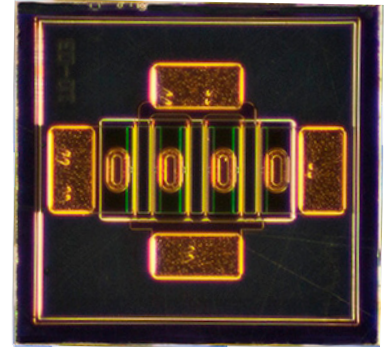

PN: CGHV1J006D

Features

- 17 dB Typ. Small Signal Gain at 10 GHz
- 60% Typ. PAE at 10 GHz
- 6 W Typical P_{SAT}
- 40 V Operation
- Up to 18 GHz Operation

Applications

- Satellite Communications
- PTP Communications Links
- Marine Radar
- Pleasure Craft Radar
- Port Vessel Traffic Services
- Broadband Amplifiers
- High Efficiency Amplifiers



Packaging Information

- Bare die are shipped in Gel-Pak® containers
- Non-adhesive tacky membrane immobilizes die during shipment



Large Signal Models Available for ADS and MWO



Absolute Maximum Ratings (not simultaneous)

Parameter	Symbol	Rating	Units	Conditions
Drain-source Voltage	V_{DS}	100	V_{DC}	25°C
Gate-source Voltage	V_{GS}	-10, +2		
Storage Temperature	T_{STG}	-65, +150	°C	
Operating Junction Temperature	T_J	225		
Maximum Forward Gate Current	I_{GMAX}	1.2	mA	25°C
Maximum Drain Current ¹	I_{DMAX}	0.8	A	
Thermal Resistance, Junction to Case (packaged) ²	$R_{\theta JC}$	17.5	°C/W	85°C
Thermal Resistance, Junction to Case (die only) ²		13.2		
Mounting Temperature	T_S	320	°C	30 seconds

Notes:

¹ Current limit for long term, reliable operation.² Eutectic die attach using 80/20 AuSn mounted to a 40 mil thick CuMoCu carrier.

Electrical Characteristics (Frequency = 10 GHz unless otherwise stated; $T_c = 25^\circ\text{C}$)

Characteristics	Symbol	Min.	Typ.	Max.	Units	Conditions
DC Characteristics						
Gate Threshold Voltage	$V_{(GS)TH}$	-3.8	-3.0	-2.3	V	$V_{DS} = 10\text{ V}, I_D = 1.2\text{ mA}$
Gate Quiescent Voltage	$V_{(GS)Q}$	-	-2.7	-	V_{DC}	$V_{DD} = 40\text{ V}, I_{DQ} = 70\text{ mA}$
Saturated Drain Current ¹	I_{SAT}	1.0	1.1	-	A	$V_{DS} = 6.0\text{ V}, V_{GS} = 2.0\text{ V}$
Drain-Source Breakdown Voltage	V_{BD}	100	-	-	V	$V_{GS} = -8\text{ V}, I_D = 1.2\text{ mA}$
On Resistance	R_{ON}	-	2.3	-	Ω	$V_{DS} = 0.1\text{ V}, V_{GS} = 0\text{ V}$
Gate Forward Voltage	V_{G-ON}	-	1.85	-	V	$I_{GS} = 1.2\text{ mA}$
RF Characteristics						
Small Signal Gain	G_{SS}	-	17	-	dB	$V_{DD} = 40\text{ V}, I_{DQ} = 70\text{ mA}$
Saturated Power Output ¹	P_{SAT}	-	6	-	W	
Drain Efficiency ²	η	-	60	-	%	$V_{DD} = 40\text{ V}, I_{DQ} = 70\text{ mA}, P_{OUT} = 6\text{ W PEP}$
Intermodulation Distortion	IM3	-	-30	-	dBc	
Output Mismatch Stress	VSWR	-	-	10 : 1	Ψ	No damage at all phase angles, $V_{DD} = 40\text{ V}, I_{DQ} = 70\text{ mA},$ $P_{OUT} = 6\text{ W CW}$
Dynamic Characteristics						
Input Capacitance	C_{GS}	-	2.0	-	pF	$V_{DS} = 40\text{ V}, V_{GS} = -8\text{ V}, f = 1\text{ MHz}$
Output Capacitance	C_{DS}	-	0.35	-		
Feedback Capacitance	C_{GD}	-	0.5	-		

Notes:

¹ Scaled from PCM unit cell³ Drain Efficiency = P_{OUT} / P_{DC} ² P_{SAT} is defined as $I_G = 0.12\text{ mA}$

2

MACOM Technology Solutions Inc. (MACOM) and its affiliates reserve the right to make changes to the product(s) or information contained herein without notice. Visit www.macom.com for additional data sheets and product information.

For further information and support please visit:
<https://www.macom.com/support>

Rev. 2.0, 2022-7-27

Die Dimensions (units in microns)

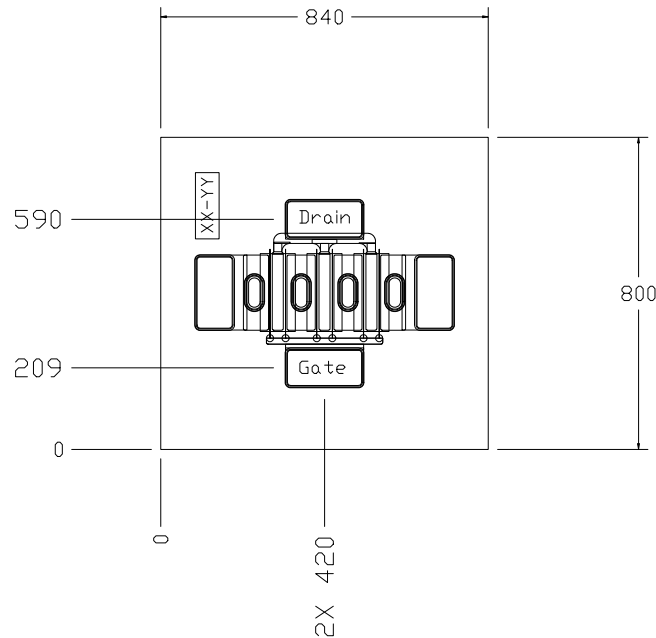

Overall die size 800 x 840 (+0/-50) microns, die thickness 100 (+/-10) microns.
All Gate and Drain pads must be wire bonded for electrical connection.

Pad	Size (microns)
Drain	202 x 102
Gate	202 x 102

Assembly Notes

- Recommended solder is AuSn (80/20) solder. Refer to the website for the Eutectic Die Attach Procedure application note
- Vacuum collet is the preferred method of pick-up
- The backside of the die is the Source (ground) contact
- Die back side gold plating is 5 microns thick minimum
- Thermosonic ball or wedge bonding are the preferred connection methods
- Gold wire must be used for connections
- Use the die label (XX-YY) for correct orientation

Electrostatic Discharge (ESD) Classifications

Parameter	Symbol	Class	Classification Level	Test Methodology
Human Body Model	HBM	1A	ANSI/ESDA/JEDEC JS-001 Table 3	JEDEC JESD22 A114-D

G_{MAX} and K Factor

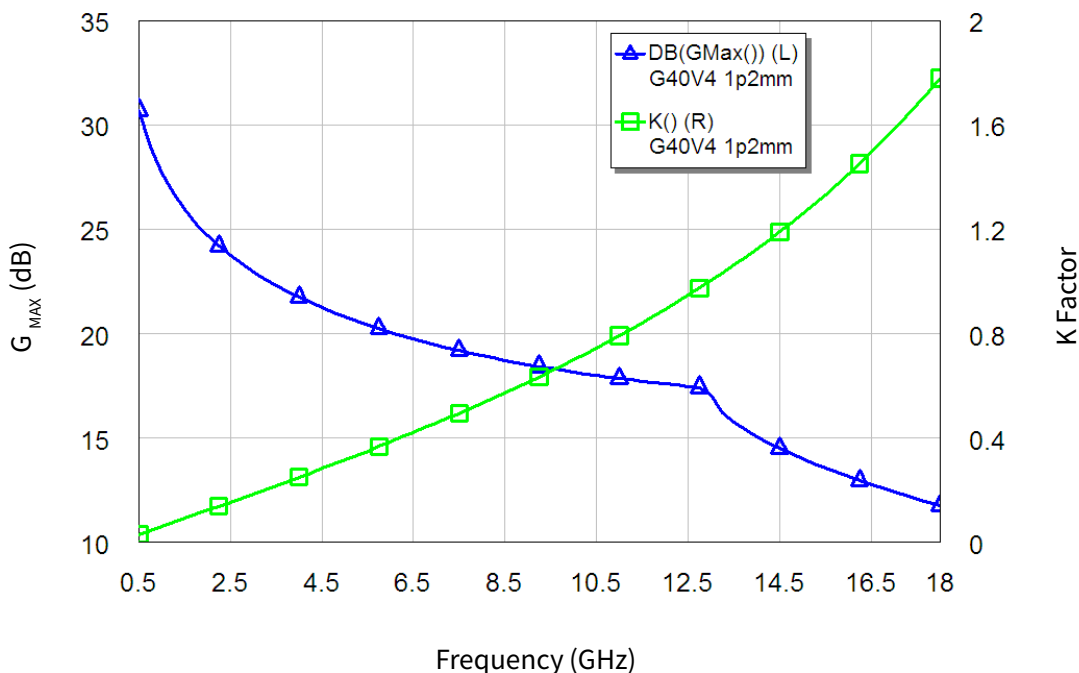

Figure 1. CGHV1J006D - Stability with G_{MAX} and K Factor
 $V_{DD} = 40\text{ V}$, $I_{DS} = 30\text{ mA}$

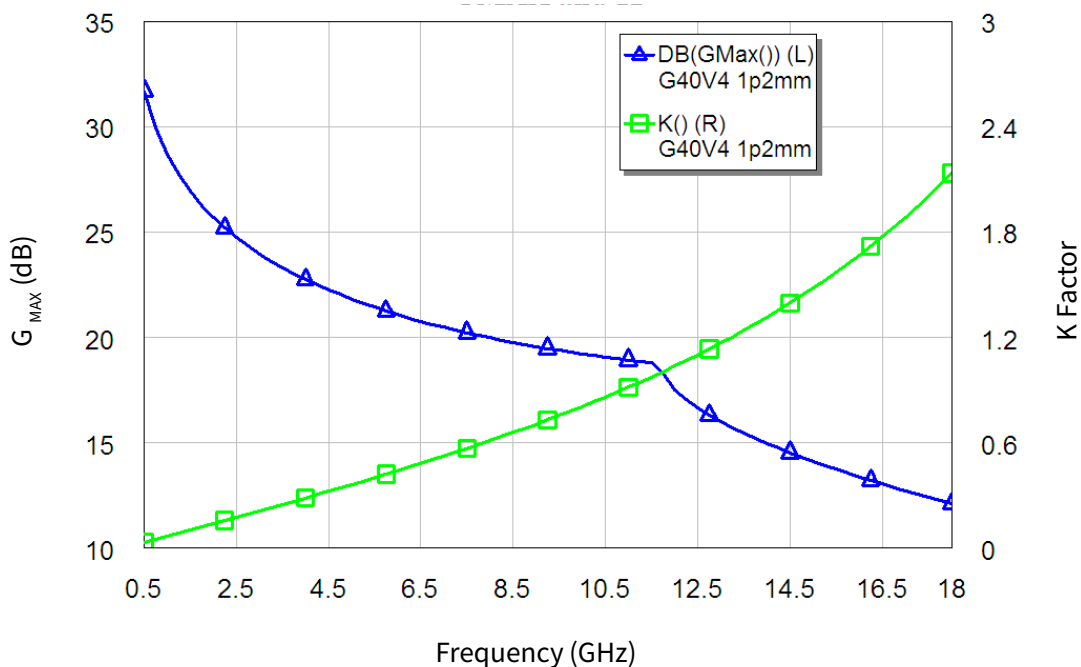
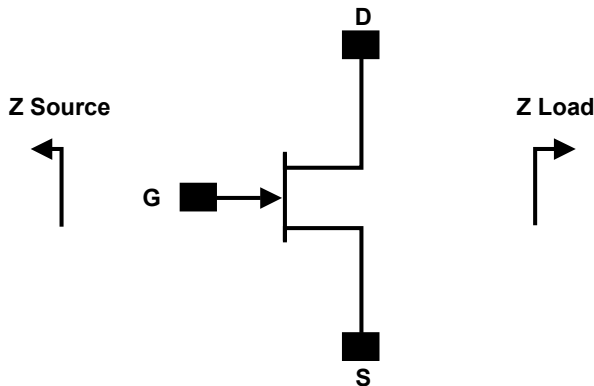

Figure 2. CGHV1J006D - Stability with G_{MAX} and K Factor
 $V_{DD} = 40\text{ V}$, $I_{DS} = 60\text{ mA}$

Source and Load Impedances



Note: $V_{DD} = 40\text{ V}$, $I_{DQ} = 45\text{ mA}$

Frequency (GHz)	Z Source	Z Load
1.0	33.5 + j43.4	136.8 + j99
2.0	14.8 + j19.9	66.1 + j103.5
3.0	8.92 + j13.2	36.3 + j81.3
4.0	7.28 + j9.64	25 + j69.1
5.0	6.25 + j7.2	19.1 + j58
6.0	5.4 + j5.2	13.47 + j49.5
7.0	4.9 + j3.54	11 + j43.4
8.0	4.67 + j2.39	9.84 + j38.5
9.0	4 + j1.21	8.76 + j34.2
10.0	3.56 + j0.155	7.93 + j30.75
11.0	3.2 - j0.226	7.68 + j27.87
12.0	1.7 - j0.35	7.36 + j24.8
13.0	1.68 - j1.27	6.76 + j23
14.0	1.73 - j2.18	5.59 + j20.5
15.0	1.99 - j3.04	4.88 + j18.76
16.0	2.41 - j3.89	4.27 + j17.11
17.0	1.72 - j4.84	3.9 + j15.26
18.0	2.1 - j5.71	3.4 + j14

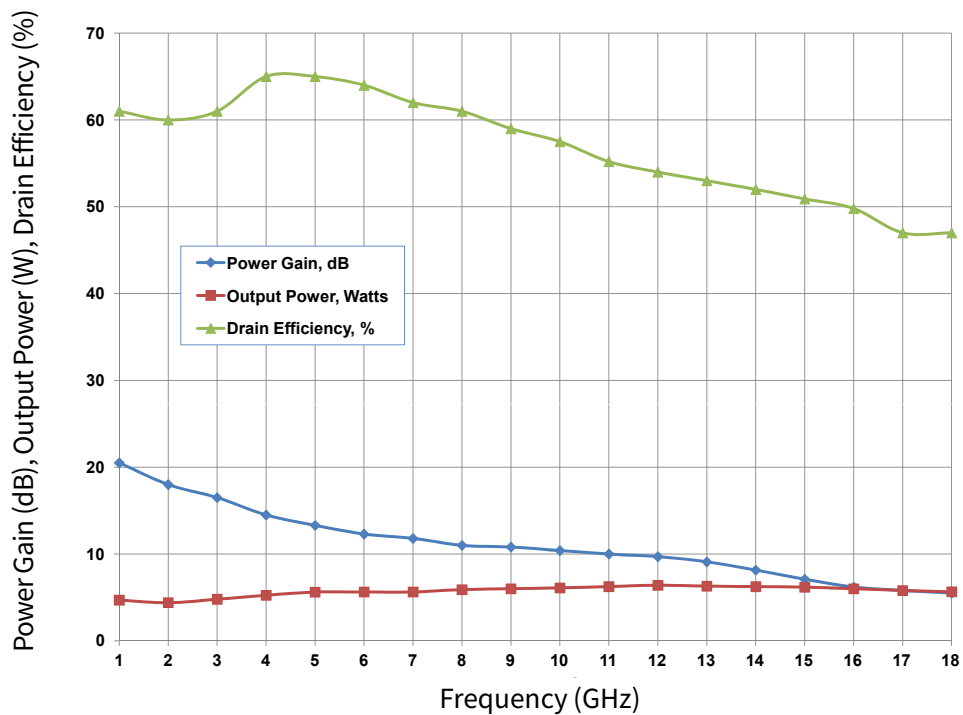

Figure 3. CGHV1J006D - Power Gain, Output Power and Drain Efficiency using Source and Load Pull Impedances (Series gate stability resistor values chosen to make $K > 1$)

Typical S-Parameters for CGHV1J006D
(Small Signal, $V_{DS} = 40$ V, $I_{DQ} = 30$ mA, angle in degrees)

Frequency	Mag S11	Ang S11	Mag S21	Ang S21	Mag S12	Ang S12	Mag S22	Ang S22
500 MHz	0.987	-38.19	15.03	156.70	0.013	67.25	0.827	-13.92
1.00 GHz	0.962	-69.56	12.91	137.32	0.022	48.44	0.769	-25.11
1.50 GHz	0.940	-92.69	10.74	122.53	0.027	34.21	0.717	-33.51
2.00 GHz	0.925	-109.31	8.96	111.22	0.030	23.46	0.681	-40.24
2.50 GHz	0.915	-121.46	7.56	102.25	0.032	15.04	0.660	-46.13
3.00 GHz	0.910	-130.61	6.48	94.83	0.033	8.18	0.649	-51.59
3.50 GHz	0.906	-137.71	5.63	88.46	0.033	2.38	0.646	-56.81
4.00 GHz	0.904	-143.40	4.95	82.85	0.033	-2.67	0.647	-61.83
4.50 GHz	0.903	-148.06	4.39	77.79	0.033	-7.17	0.651	-66.69
5.00 GHz	0.903	-151.98	3.93	73.16	0.033	-11.24	0.658	-71.37
5.50 GHz	0.903	-155.34	3.54	68.86	0.032	-14.97	0.666	-75.87
6.00 GHz	0.904	-158.26	3.21	64.84	0.032	-18.42	0.675	-80.19
6.50 GHz	0.904	-160.85	2.93	61.05	0.031	-21.64	0.685	-84.33
7.00 GHz	0.905	-163.18	2.68	57.46	0.030	-24.66	0.695	-88.30
7.50 GHz	0.906	-165.28	2.47	54.05	0.030	-27.50	0.706	-92.09
8.00 GHz	0.908	-167.22	2.27	50.79	0.029	-30.19	0.716	-95.71
8.50 GHz	0.909	-169.00	2.11	47.66	0.028	-32.73	0.726	-99.18
9.00 GHz	0.910	-170.67	1.95	44.67	0.027	-35.14	0.736	-102.49
9.50 GHz	0.911	-172.24	1.82	41.78	0.027	-37.44	0.746	-105.65
10.00 GHz	0.912	-173.72	1.70	39.01	0.026	-39.63	0.755	-108.67
10.50 GHz	0.914	-175.12	1.59	36.33	0.025	-41.71	0.764	-111.56
11.00 GHz	0.915	-176.47	1.49	33.74	0.024	-43.70	0.773	-114.33
11.50 GHz	0.916	-177.75	1.40	31.23	0.024	-45.60	0.781	-116.99
12.00 GHz	0.917	-179.00	1.31	28.80	0.023	-47.41	0.788	-119.53
12.50 GHz	0.918	-179.80	1.24	26.45	0.022	-49.15	0.796	-121.97
13.00 GHz	0.919	-178.64	1.17	24.16	0.021	-50.81	0.803	-124.31
13.50 GHz	0.920	-177.51	1.10	21.94	0.021	-52.40	0.809	-126.57
14.00 GHz	0.921	-176.41	1.05	19.78	0.020	-53.91	0.816	-128.74
14.50 GHz	0.922	-175.33	0.99	17.67	0.019	-55.37	0.822	-130.82
15.00 GHz	0.922	-174.27	0.94	15.62	0.019	-56.75	0.827	-132.84
15.25 GHz	0.923	-173.75	0.92	14.61	0.018	-57.42	0.830	-133.82
15.50 GHz	0.923	-173.24	0.90	13.62	0.018	-58.08	0.833	-134.78
15.75 GHz	0.923	-172.73	0.87	12.64	0.017	-58.71	0.835	-135.73
16.00 GHz	0.924	-172.22	0.85	11.66	0.017	-59.34	0.838	-136.66
16.25 GHz	0.924	-171.72	0.83	10.70	0.017	-59.95	0.840	-137.57
16.50 GHz	0.924	-171.22	0.81	9.75	0.016	-60.54	0.843	-138.47
16.75 GHz	0.925	-170.72	0.79	8.81	0.016	-61.12	0.845	-139.36
17.00 GHz	0.925	-170.23	0.78	7.88	0.016	-61.68	0.847	-140.23
17.25 GHz	0.925	-169.74	0.76	6.96	0.015	-62.23	0.849	-141.09
17.50 GHz	0.926	-169.26	0.74	6.05	0.015	-62.77	0.851	-141.93
17.75 GHz	0.926	-168.77	0.72	5.15	0.015	-63.29	0.853	-142.76
18.00 GHz	0.926	-168.29	0.71	4.26	0.015	-63.79	0.855	-143.58

To download the s-parameters in s2p format, go to the CGHV1J006D Product page.

Typical S-Parameters for CGHV1J006D
 (Small Signal, $V_{DS} = 40\text{ V}$, $I_{DQ} = 60\text{ mA}$, angle in degrees)

Frequency	Mag S11	Ang S11	Mag S21	Ang S21	Mag S12	Ang S12	Mag S22	Ang S22
500 MHz	0.984	-43.78	18.23	153.94	0.012	64.52	0.776	-15.67
1.00 GHz	0.956	-77.79	15.10	133.43	0.020	44.60	0.706	-27.34
1.50 GHz	0.935	-101.29	12.21	118.66	0.025	30.42	0.650	-35.52
2.00 GHz	0.922	-117.38	9.99	107.78	0.027	20.12	0.616	-41.92
2.50 GHz	0.914	-128.78	8.34	99.30	0.028	12.23	0.598	-47.57
3.00 GHz	0.909	-137.20	7.10	92.33	0.029	5.85	0.590	-52.89
3.50 GHz	0.906	-143.67	6.14	86.37	0.029	0.48	0.590	-58.01
4.00 GHz	0.905	-148.80	5.38	81.10	0.029	-4.20	0.594	-62.98
4.50 GHz	0.904	-153.01	4.76	76.33	0.028	-8.37	0.601	-67.78
5.00 GHz	0.904	-156.53	4.26	71.95	0.028	-12.16	0.610	-72.42
5.50 GHz	0.905	-159.55	3.84	67.88	0.028	-15.63	0.620	-76.88
6.00 GHz	0.905	-162.19	3.48	64.05	0.027	-18.86	0.631	-81.15
6.50 GHz	0.906	-164.52	3.17	60.43	0.027	-21.87	0.643	-85.25
7.00 GHz	0.907	-166.62	2.90	56.99	0.026	-24.70	0.655	-89.17
7.50 GHz	0.908	-168.54	2.67	53.70	0.025	-27.38	0.667	-92.91
8.00 GHz	0.909	-170.29	2.46	50.56	0.025	-29.90	0.679	-96.48
8.50 GHz	0.910	-171.92	2.28	47.54	0.024	-32.30	0.691	-99.90
9.00 GHz	0.912	-173.45	2.12	44.63	0.023	-34.58	0.702	-103.16
9.50 GHz	0.913	-174.89	1.97	41.83	0.023	-36.75	0.713	-106.27
10.00 GHz	0.914	-176.25	1.84	39.12	0.022	-38.81	0.724	-109.25
10.50 GHz	0.915	-177.55	1.72	36.51	0.021	-40.78	0.734	-112.10
11.00 GHz	0.916	-178.80	1.62	33.97	0.021	-42.65	0.744	-114.83
11.50 GHz	0.917	-180.00	1.52	31.52	0.020	-44.44	0.753	-117.45
12.00 GHz	0.918	-178.84	1.43	29.14	0.019	-46.14	0.762	-119.96
12.50 GHz	0.919	-177.72	1.35	26.82	0.019	-47.77	0.770	-122.37
13.00 GHz	0.920	-176.62	1.27	24.57	0.018	-49.31	0.778	-124.68
13.50 GHz	0.921	-175.56	1.20	22.38	0.017	-50.79	0.786	-126.90
14.00 GHz	0.922	-174.52	1.14	20.25	0.017	-52.19	0.793	-129.05
14.50 GHz	0.922	-173.49	1.08	18.16	0.016	-53.52	0.800	-131.11
15.00 GHz	0.923	-172.49	1.03	16.13	0.015	-54.78	0.806	-133.10
15.25 GHz	0.923	-172.00	1.00	15.14	0.015	-55.38	0.810	-134.07
15.50 GHz	0.924	-171.51	0.98	14.15	0.015	-55.97	0.813	-135.02
15.75 GHz	0.924	-171.02	0.95	13.18	0.015	-56.53	0.816	-135.96
16.00 GHz	0.924	-170.54	0.93	12.21	0.014	-57.09	0.818	-136.88
16.25 GHz	0.925	-170.06	0.91	11.26	0.014	-57.62	0.821	-137.79
16.50 GHz	0.925	-169.58	0.89	10.32	0.014	-58.13	0.824	-138.68
16.75 GHz	0.925	-169.11	0.87	9.38	0.013	-58.63	0.827	-139.55
17.00 GHz	0.926	-168.63	0.85	8.46	0.013	-59.11	0.829	-140.42
17.25 GHz	0.926	-168.16	0.83	7.54	0.013	-59.57	0.832	-141.27
17.50 GHz	0.926	-167.70	0.81	6.64	0.012	-60.02	0.834	-142.10
17.75 GHz	0.926	-167.23	0.79	5.74	0.012	-60.44	0.836	-142.93
18.00 GHz	0.927	-166.77	0.78	4.86	0.012	-60.84	0.839	-143.74

To download the s-parameters in s2p format, go to the CGHV1J006D Product page.

Part Number System

CGHV1J006D

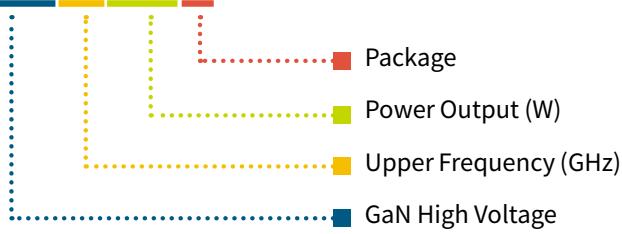

Table 1.

Parameter	Value	Units
Lower Frequency	DC	GHz
Upper Frequency ¹	18.0	GHz
Power Output	6	W
Package	Bare Die	-

Notes:

¹ Alpha characters used in frequency code indicate a value greater than 9.9 GHz. See Table 2 for value

Table 2.

Parameter	Value
A	0
B	1
C	2
D	3
E	4
F	5
G	6
H	7
J	8
K	9
Examples:	1A = 10.0 GHz 2H = 27.0 GHz

Product Ordering Information

Order Number	Description	Unit of Measure
CGHV1J006D	GaN HEMT Bare Die	Each

Notes & Disclaimer

MACOM Technology Solutions Inc. ("MACOM"). All rights reserved.

These materials are provided in connection with MACOM's products as a service to its customers and may be used for informational purposes only. Except as provided in its Terms and Conditions of Sale or any separate agreement, MACOM assumes no liability or responsibility whatsoever, including for (i) errors or omissions in these materials; (ii) failure to update these materials; or (iii) conflicts or incompatibilities arising from future changes to specifications and product descriptions, which MACOM may make at any time, without notice. These materials grant no license, express or implied, to any intellectual property rights.

THESE MATERIALS ARE PROVIDED "AS IS" WITH NO WARRANTY OR LIABILITY, EXPRESS OR IMPLIED, RELATING TO SALE AND/OR USE OF MACOM PRODUCTS INCLUDING FITNESS FOR A PARTICULAR PURPOSE, MERCHANTABILITY, INFRINGEMENT OF INTELLECTUAL PROPERTY RIGHT, ACCURACY OR COMPLETENESS, OR SPECIAL, INDIRECT, INCIDENTAL, OR CONSEQUENTIAL DAMAGES WHICH MAY RESULT FROM USE OF THESE MATERIALS.

MACOM products are not intended for use in medical, lifesaving or life sustaining applications. MACOM customers using or selling MACOM products for use in such applications do so at their own risk and agree to fully indemnify MACOM for any damages resulting from such improper use or sale.