

Rev No.	Description of Revision	Date	Name	Approved	ECN No.

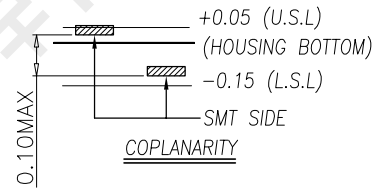
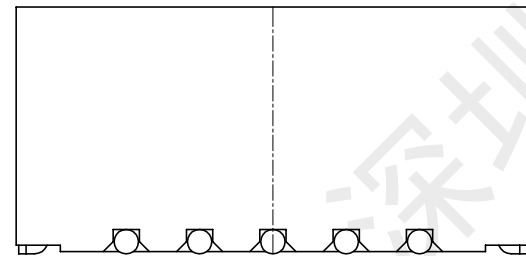
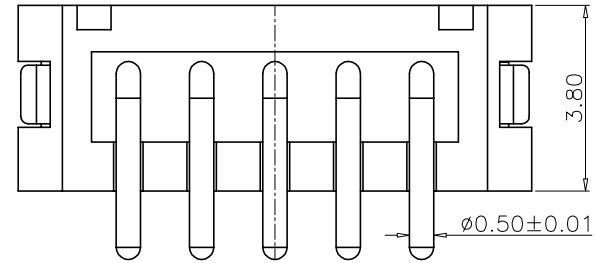
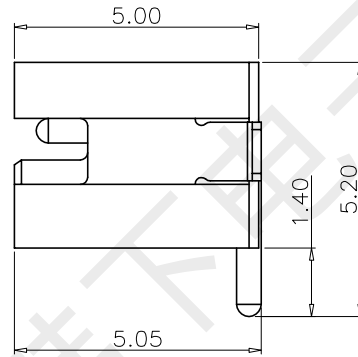
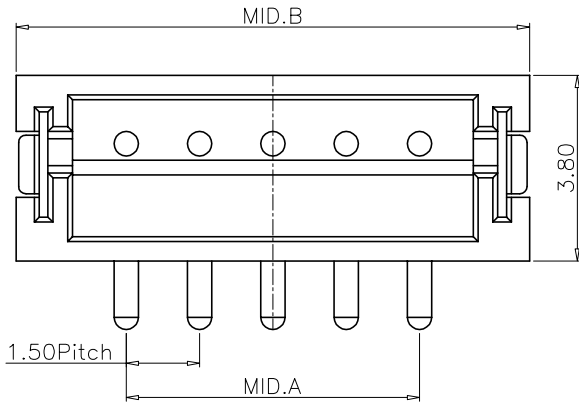
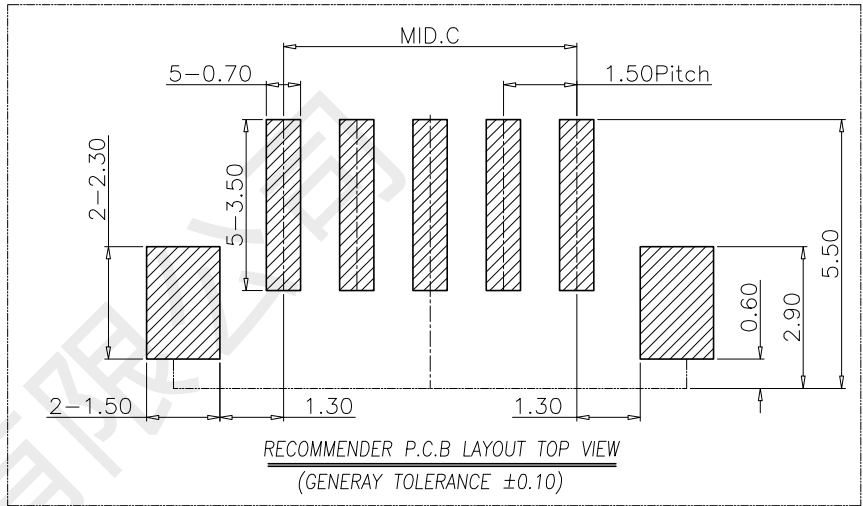
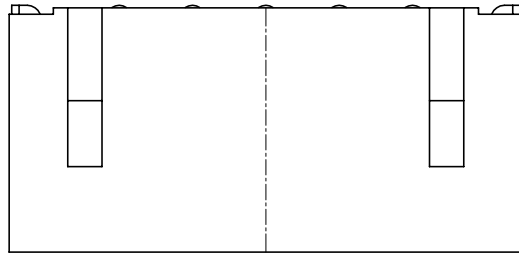

PIN数	MID. A	MID. B	MID. C
2P	1.50	6.00	1.50
3P	3.00	7.50	3.00
4P	4.50	9.00	4.50
5P	6.00	10.50	6.00

序号	配件名称	材质	电镀颜色	数量
③	圆针	黄铜H65	镀亮锡	5PCS
②	固定片	黄铜H65	镀亮锡	2PCS
①	塑胶主体	LCP	本色	1PCS

Specifications:

1. Rated Voltage :125V AC/DC
2. Rated Current : 2A AC,DC
3. Withstand Voltage :200V AC/minute
4. Contact Resistance:50mΩ (MAX.)
5. Insulation Resistance:100mΩ (MIN.)
6. Storage Temperature Range:-40°C~+85°C;
7. Operation Temperature Range:-25°C~+70°C;

UNLESS OTHERWISE SPECIFIED TOLERANCES

深圳市韩下电子有限公司
 TITLE: HX-ZH1.5-4ALB

DECIMALS:	ANGLES	Drwn:	PART NO.
X. ±0.15	X' ±2'	黄彬	WF005-LT15002-02
X.X ±0.10	X.X' ±1'	Checked: 张伟	SCALE: 1:8
X.XX ±0.05	X.XX' ±0.5'	Approved: 罗小春	UNIT: mm
X.XXX ±0.03			PROJ:
			SIZE: A4
			SHEET: 1 OF 1
			REV: A

CUSTOMER COPY