

Trench gate field-stop, 1200 V, 8 A, low-loss M series IGBT in a TO-220 package

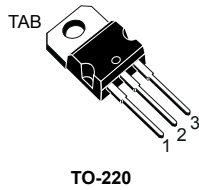

TO-220

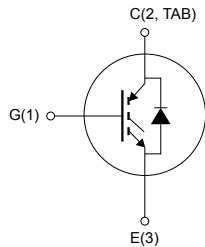

NG1E3C2T

Features

- 10 μ s of minimum short-circuit withstand time
- $V_{CE(sat)} = 1.85$ V (typ.) @ $I_C = 8$ A
- Tight parameter distribution
- Positive $V_{CE(sat)}$ temperature coefficient
- Low thermal resistance
- Soft and very fast recovery antiparallel diode
- Maximum junction temperature: $T_J = 175$ °C

Applications

- Industrial drives
- UPS
- Solar
- Welding
- General-purpose inverters

Description

This device is an IGBT developed using an advanced proprietary trench gate field-stop structure. The device is part of the M series IGBTs, which represent an optimal balance between inverter system performance and efficiency where low-loss and short-circuit functionality are essential. Furthermore, the positive $V_{CE(sat)}$ temperature coefficient and tight parameter distribution result in safer paralleling operation.

Product status link

[STGP8M120DF3](#)

Product summary

Order code	STGP8M120DF3
Marking	G8M120DF3
Package	TO-220
Packing	Tube

1 Electrical ratings

Table 1. Absolute maximum ratings

Symbol	Parameter	Value	Unit
V_{CES}	Collector-emitter voltage ($V_{GE} = 0$ V)	1200	V
I_C	Continuous collector current at $T_C = 25$ °C	16	A
	Continuous collector current at $T_C = 100$ °C	8	A
$I_{CP}^{(1)}$	Pulsed collector current	32	A
V_{GE}	Gate-emitter voltage	±20	V
I_F	Continuous forward current at $T_C = 25$ °C	16	A
	Continuous forward current at $T_C = 100$ °C	8	A
$I_{FP}^{(1)}$	Pulsed forward current	32	A
P_{TOT}	Total dissipation at $T_C = 25$ °C	167	W
T_{STG}	Storage temperature range	-55 to 150	°C
T_J	Operating junction temperature range	-55 to 175	°C

1. Pulse width is limited by maximum junction temperature.

Table 2. Thermal data

Symbol	Parameter	Value	Unit
R_{thJC}	Thermal resistance junction-case IGBT	0.9	°C/W
	Thermal resistance junction-case diode	1.47	°C/W
R_{thJA}	Thermal resistance junction-ambient	50	°C/W

2 Electrical characteristics

$T_C = 25\text{ °C}$ unless otherwise specified

Table 3. Static characteristics

Symbol	Parameter	Test conditions	Min.	Typ.	Max.	Unit
$V_{(BR)CES}$	Collector-emitter breakdown voltage	$V_{GE} = 0\text{ V}$, $I_C = 2\text{ mA}$	1200			V
$V_{CE(sat)}$	Collector-emitter saturation voltage	$V_{GE} = 15\text{ V}$, $I_C = 8\text{ A}$		1.85	2.3	V
		$V_{GE} = 15\text{ V}$, $I_C = 8\text{ A}$, $T_J = 125\text{ °C}$		2.1		
		$V_{GE} = 15\text{ V}$, $I_C = 8\text{ A}$, $T_J = 175\text{ °C}$		2.2		
V_F	Forward on-voltage	$I_F = 8\text{ A}$		2.4	3.35	V
		$I_F = 8\text{ A}$, $T_J = 125\text{ °C}$		1.75		
		$I_F = 8\text{ A}$, $T_J = 175\text{ °C}$		1.55		
$V_{GE(th)}$	Gate threshold voltage	$V_{CE} = V_{GE}$, $I_C = 500\text{ }\mu\text{A}$	5	6	7	V
I_{CES}	Collector cut-off current	$V_{CE} = 1200\text{ V}$			25	μA
I_{GES}	Gate-emitter leakage current	$V_{GE} = \pm 20\text{ V}$			± 250	μA

Table 4. Dynamic characteristics

Symbol	Parameter	Test conditions	Min.	Typ.	Max.	Unit
C_{ies}	Input capacitance	$V_{CE} = 25\text{ V}$, $f = 1\text{ MHz}$, $V_{GE} = 0\text{ V}$	-	542	-	pF
C_{oes}	Output capacitance		-	74.4	-	
C_{res}	Reverse transfer capacitance		-	21	-	
Q_g	Total gate charge	$V_{CC} = 960\text{ V}$, $I_C = 8\text{ A}$, $V_{GE} = 0\text{ to }15\text{ V}$ (see Figure 29. Gate charge test circuit)	-	32	-	nC
Q_{ge}	Gate-emitter charge		-	4.5	-	
Q_{gc}	Gate-collector charge		-	18.5	-	

Table 5. IGBT switching characteristics (inductive load)

Symbol	Parameter	Test conditions	Min.	Typ.	Max.	Unit	
$t_{d(on)}$	Turn-on delay time	$V_{CE} = 600\text{ V}$, $I_C = 8\text{ A}$, $V_{GE} = 15\text{ V}$, $R_G = 33\ \Omega$ (see Figure 28. Test circuit for inductive load switching)		20	-	ns	
t_r	Current rise time			8.4	-	ns	
$(di/dt)_{on}$	Turn-on current slope			800	-	A/ μ s	
$t_{d(off)}$	Turn-off-delay time			126	-	ns	
t_f	Current fall time			136	-	ns	
$E_{on(1)}$	Turn-on switching energy			0.39	-	mJ	
$E_{off(2)}$	Turn-off switching energy			0.37	-	mJ	
E_{ts}	Total switching energy			0.76	-	mJ	
$t_{d(on)}$	Turn-on delay time		$V_{CE} = 600\text{ V}$, $I_C = 8\text{ A}$, $V_{GE} = 15\text{ V}$, $R_G = 33\ \Omega$, $T_J = 175\text{ }^\circ\text{C}$ (see Figure 28. Test circuit for inductive load switching)		19	-	ns
t_r	Current rise time				9.8	-	ns
$(di/dt)_{on}$	Turn-on current slope			656	-	A/ μ s	
$t_{d(off)}$	Turn-off-delay time			134	-	ns	
t_f	Current fall time			222	-	ns	
$E_{on(1)}$	Turn-on switching energy			0.66	-	mJ	
$E_{off(2)}$	Turn-off switching energy			0.58	-	mJ	
E_{ts}	Total switching energy			1.24	-	mJ	
t_{sc}	Short-circuit withstand time	$V_{CC} \leq 600\text{ V}$, $V_{GE} = 15\text{ V}$, $T_{Jstart} \leq 150\text{ }^\circ\text{C}$		10		-	μ s

1. Including the reverse recovery of the diode
2. Including the tail of the collector current

Table 6. Diode switching characteristics (inductive load)

Symbol	Parameter	Test conditions	Min.	Typ.	Max.	Unit	
t_{rr}	Reverse recovery time	$I_F = 8\text{ A}$, $V_R = 600\text{ V}$, $V_{GE} = 15\text{ V}$, $R_G = 33\ \Omega$, $di/dt = 1000\text{ A}/\mu\text{s}$ (see Figure 28. Test circuit for inductive load switching)	-	103	-	ns	
Q_{rr}	Reverse recovery charge			-	0.87	-	μ C
I_{rrm}	Reverse recovery current			-	19.2	-	A
di_{rr}/dt	Peak rate of fall of reverse recovery current during t_b			-	720	-	A/ μ s
E_{rr}	Reverse recovery energy			-	211	-	μ J
t_{rr}	Reverse recovery time		$I_F = 8\text{ A}$, $V_R = 600\text{ V}$, $V_{GE} = 15\text{ V}$, $R_G = 33\ \Omega$, $T_J = 175\text{ }^\circ\text{C}$, $di/dt = 840\text{ A}/\mu\text{s}$ (see Figure 28. Test circuit for inductive load switching)	-	280	-	ns
Q_{rr}	Reverse recovery charge			-	1.9	-	μ C
I_{rrm}	Reverse recovery current			-	21.8	-	A
di_{rr}/dt	Peak rate of fall of reverse recovery current during t_b			-	450	-	A/ μ s
E_{rr}	Reverse recovery energy			-	404	-	μ J

2.1 Electrical characteristics (curves)

Figure 1. Power dissipation vs case temperature

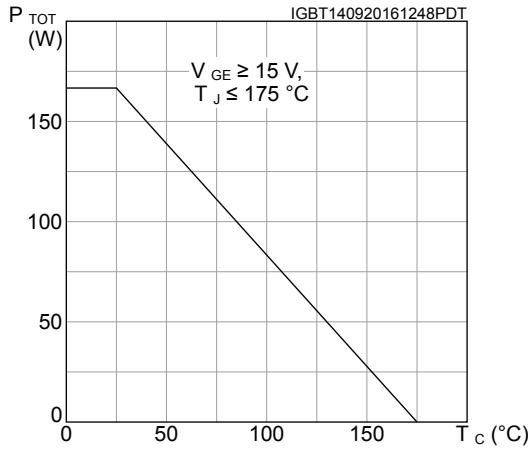

Figure 2. Collector current vs case temperature

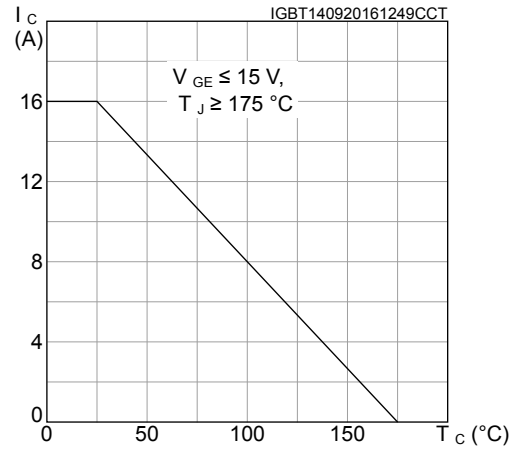

Figure 3. Output characteristics ($T_J = 25\text{ °C}$)

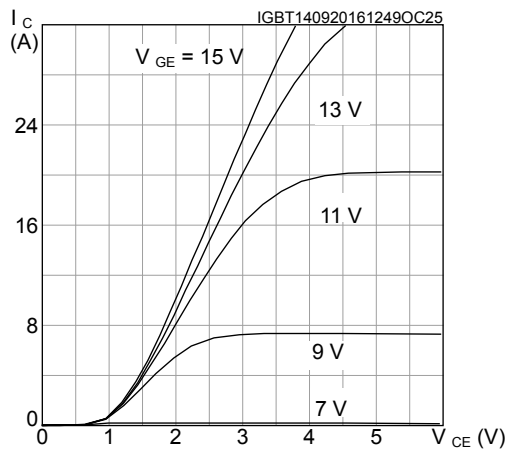

Figure 4. Output characteristics ($T_J = 175\text{ °C}$)

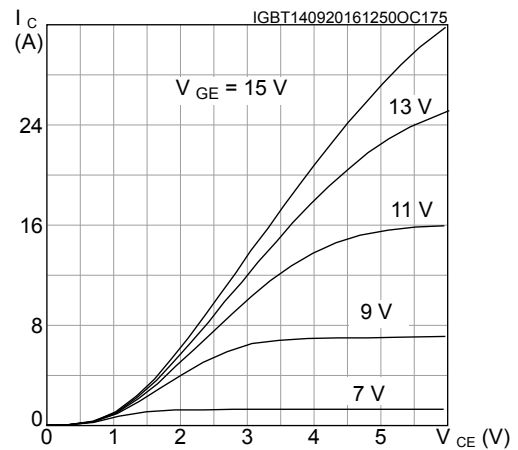

Figure 5. $V_{CE(sat)}$ vs junction temperature

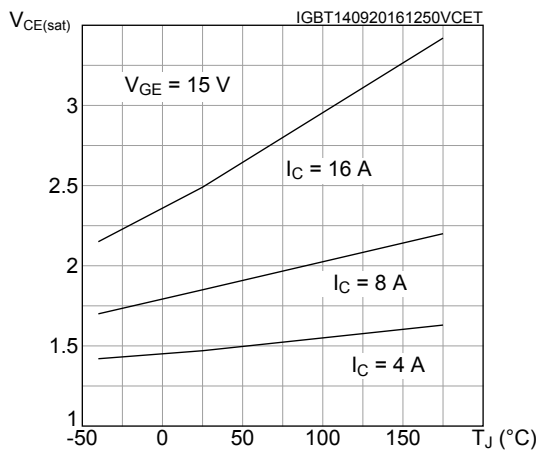

Figure 6. $V_{CE(sat)}$ vs collector current

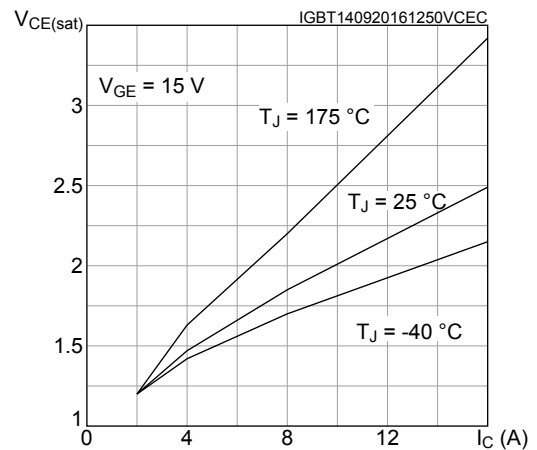

Figure 7. Collector current vs switching frequency

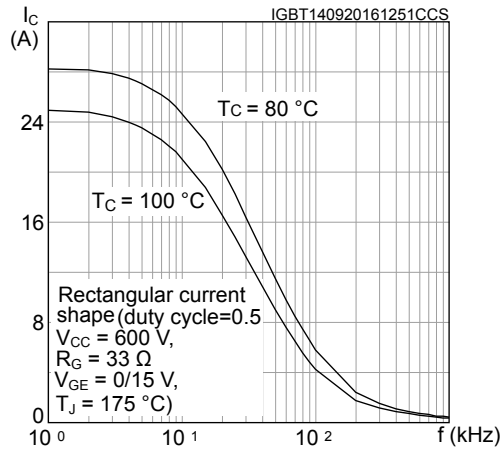

Figure 8. Forward bias safe operating area

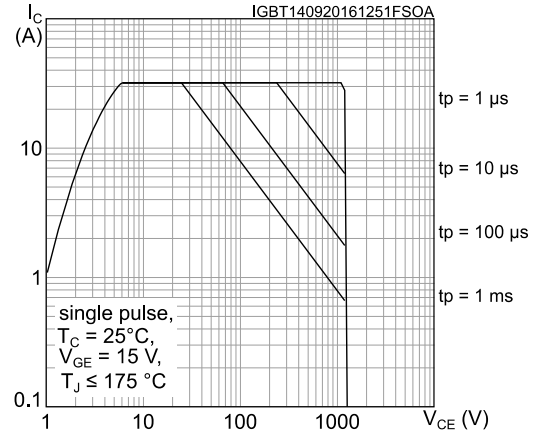

Figure 9. Transfer characteristics

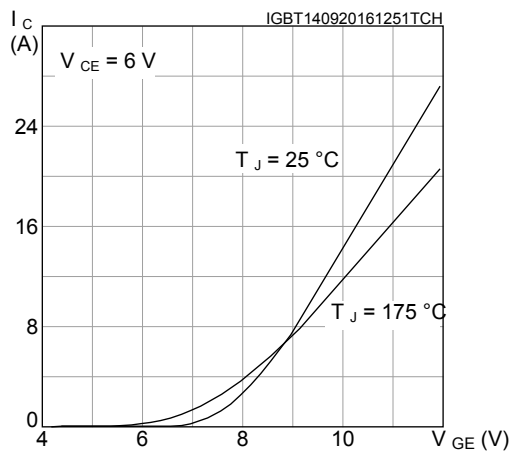

Figure 10. Diode V_F vs forward current

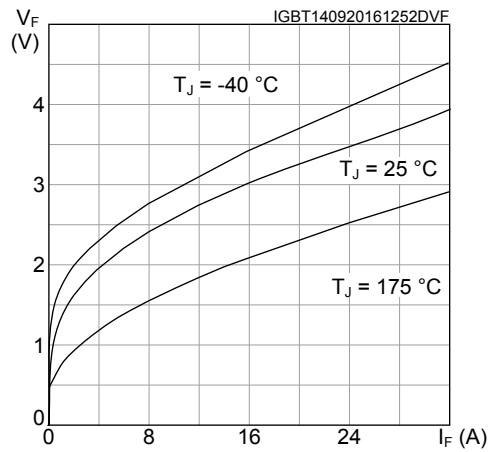

Figure 11. Normalized V_GE(th) vs junction temperature

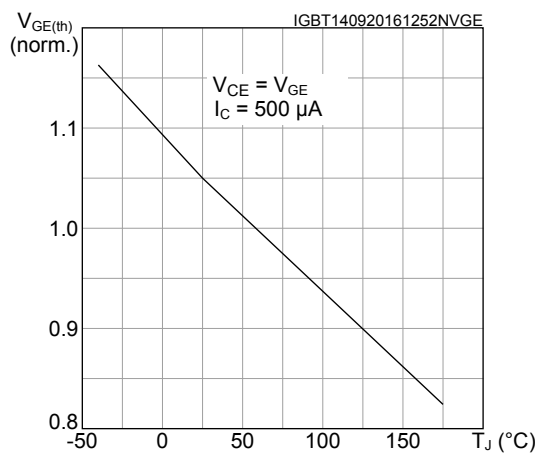

Figure 12. Normalized V_(BR)CES vs junction temperature

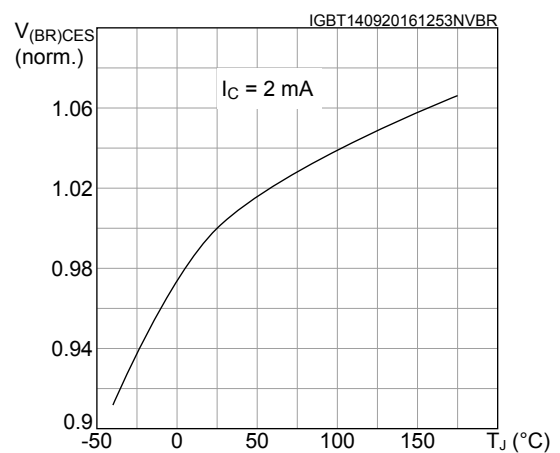

Figure 13. Capacitance variations

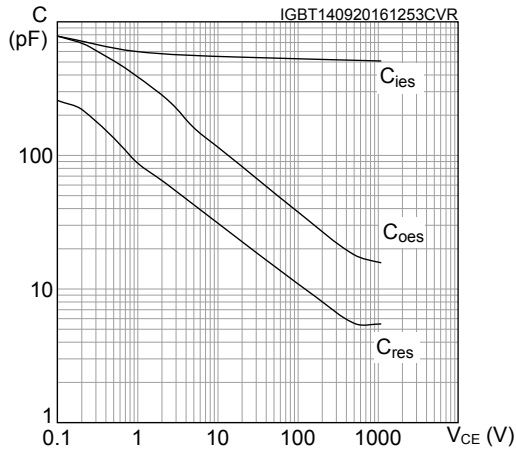

Figure 14. Gate charge vs gate-emitter voltage

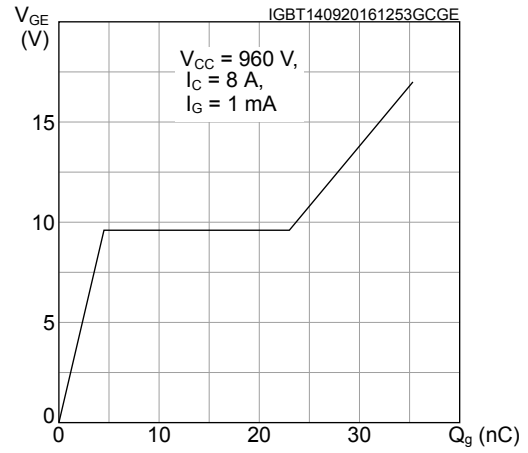

Figure 15. Switching energy vs collector current

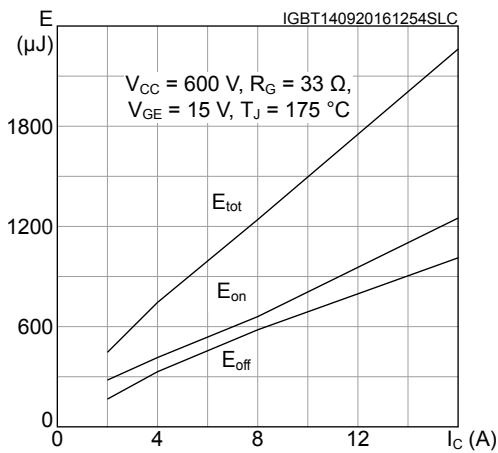

Figure 16. Switching energy vs gate resistance

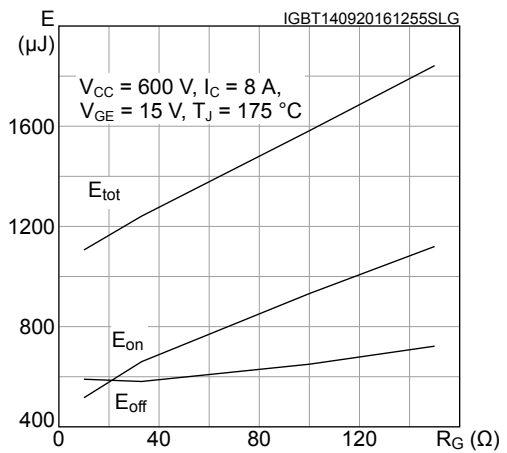

Figure 17. Switching energy vs temperature

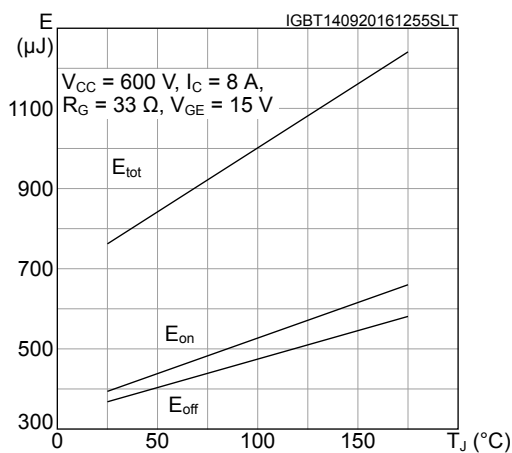

Figure 18. Switching energy vs collector emitter voltage

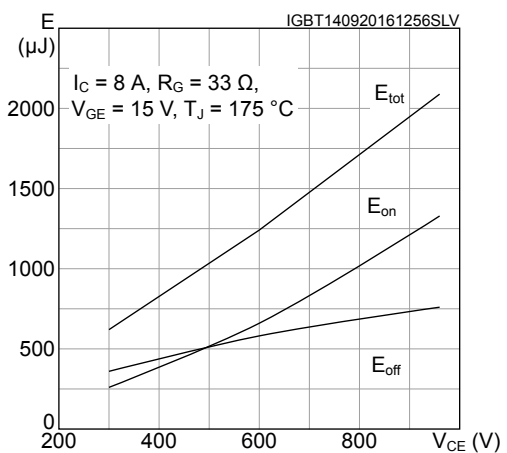

Figure 19. Short-circuit time and current vs V_{GE}

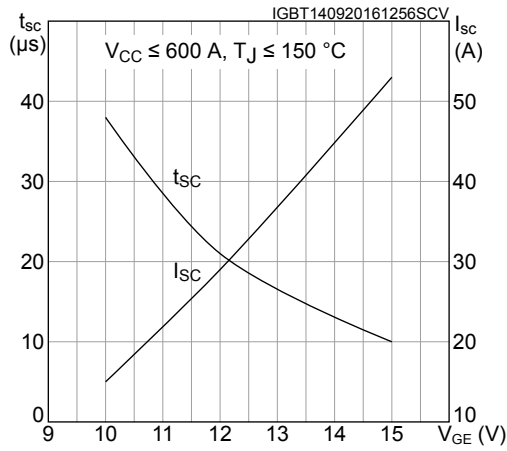

Figure 20. Switching times vs collector current

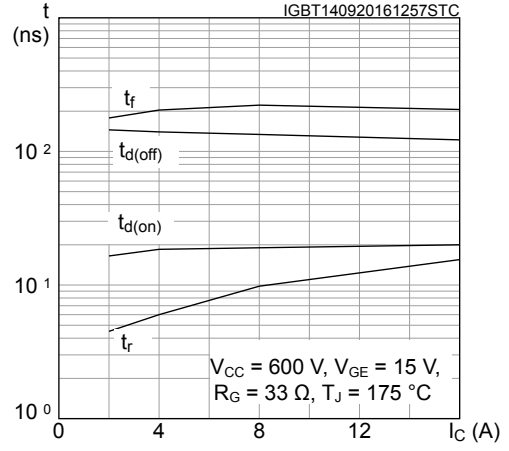

Figure 21. Switching times vs gate resistance

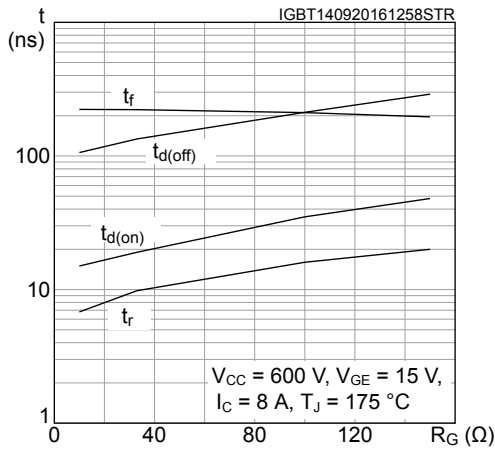

Figure 22. Reverse recovery current vs diode current slope

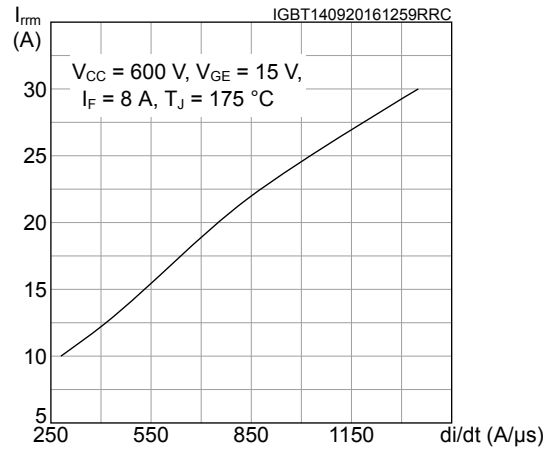

Figure 23. Reverse recovery time vs diode current slope

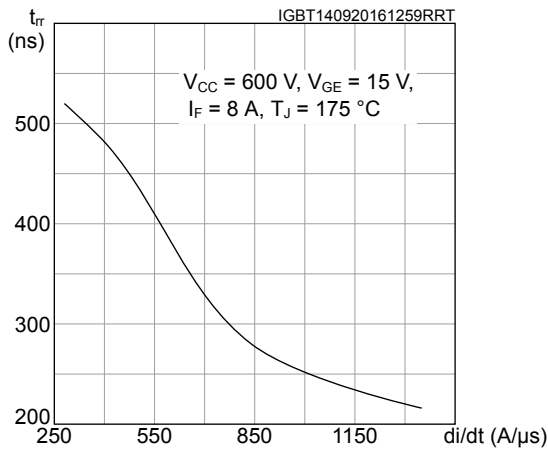

Figure 24. Reverse recovery charge vs diode current slope

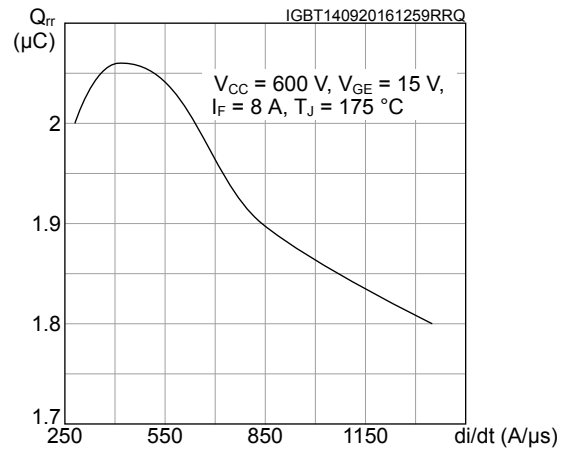

Figure 25. Reverse recovery energy vs diode current slope

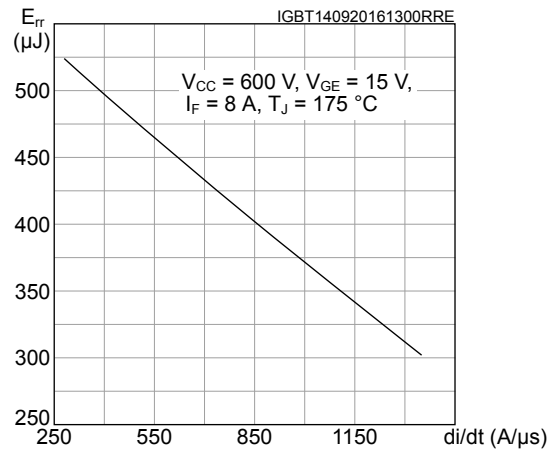

Figure 26. Thermal impedance for IGBT

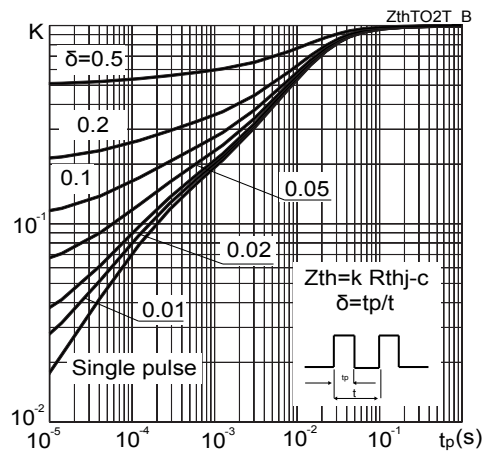
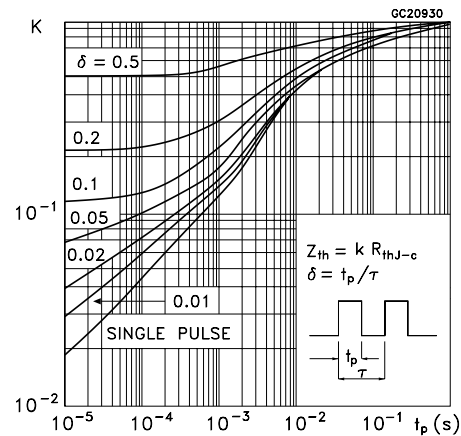
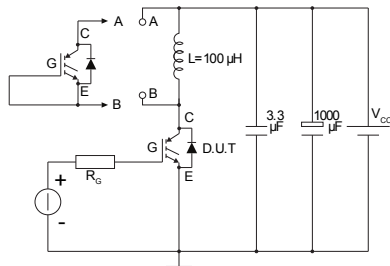

Figure 27. Thermal impedance for diode



3 Test circuits

Figure 28. Test circuit for inductive load switching

AM01504v1

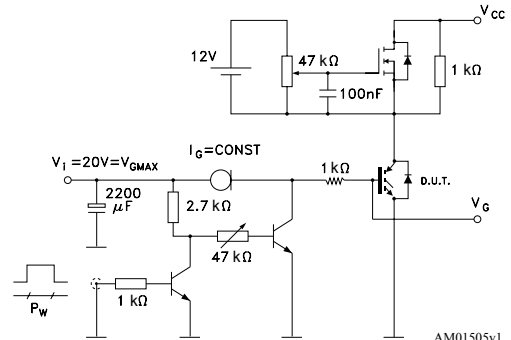
Figure 29. Gate charge test circuit

AM01505v1

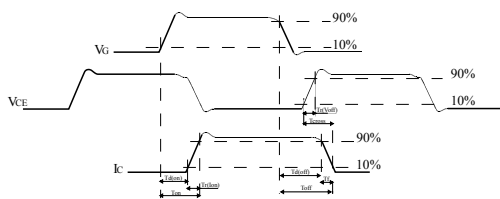
Figure 30. Switching waveform

AM01506v1

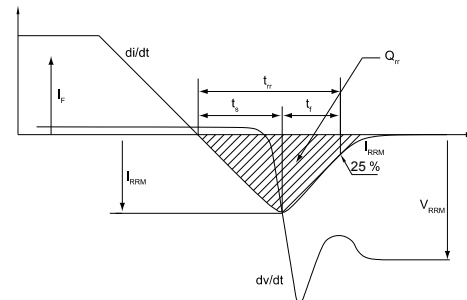
Figure 31. Diode reverse recovery waveform

AM01507v1

4 Package information

In order to meet environmental requirements, ST offers these devices in different grades of ECOPACK® packages, depending on their level of environmental compliance. ECOPACK® specifications, grade definitions and product status are available at: www.st.com. ECOPACK® is an ST trademark.

4.1 TO-220 type A package information

Figure 32. TO-220 type A package outline

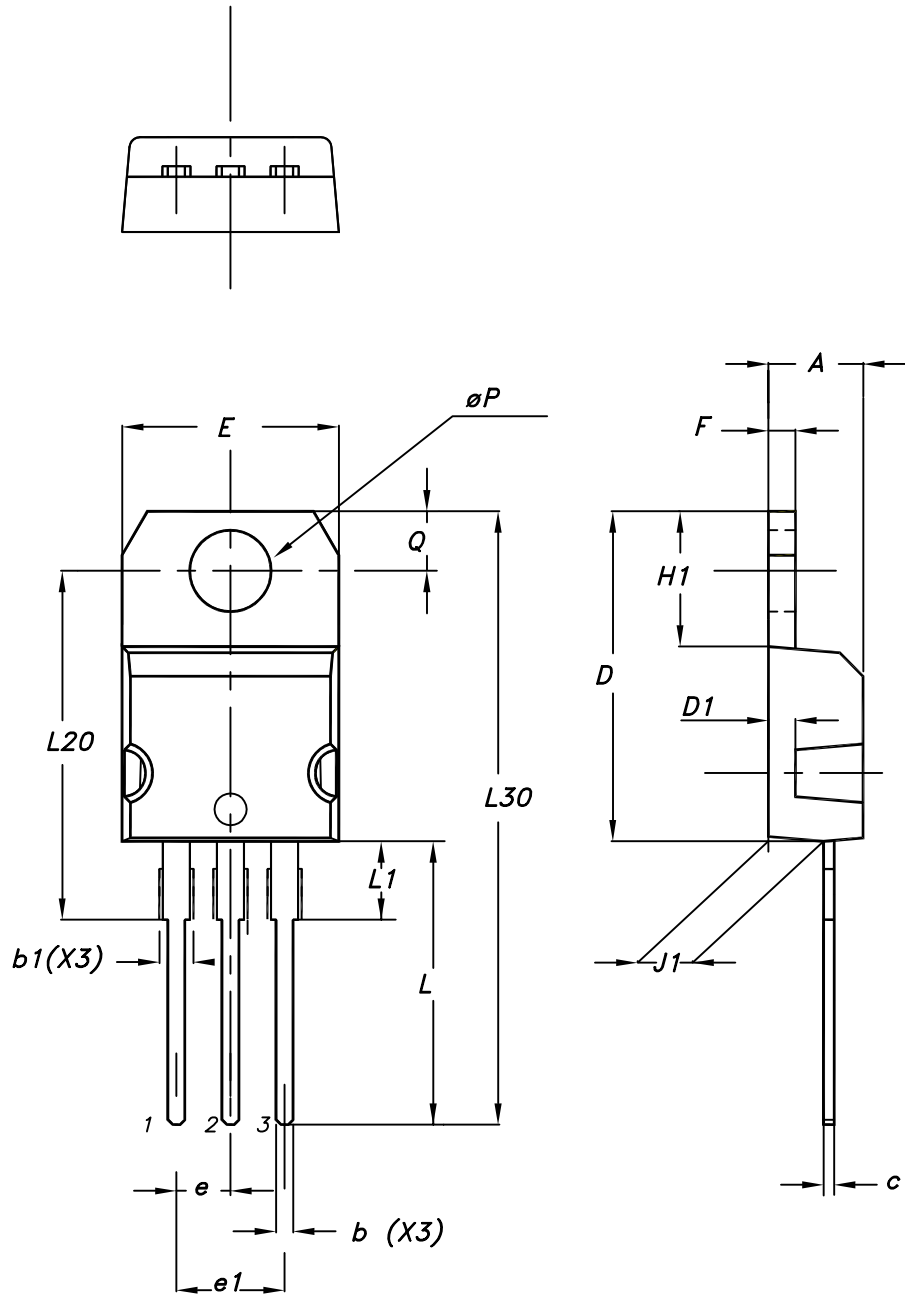

0015988_typeA_Rev_21

Table 7. TO-220 type A package mechanical data

Dim.	mm		
	Min.	Typ.	Max.
A	4.40		4.60
b	0.61		0.88
b1	1.14		1.55
c	0.48		0.70
D	15.25		15.75
D1		1.27	
E	10.00		10.40
e	2.40		2.70
e1	4.95		5.15
F	1.23		1.32
H1	6.20		6.60
J1	2.40		2.72
L	13.00		14.00
L1	3.50		3.93
L20		16.40	
L30		28.90	
øP	3.75		3.85
Q	2.65		2.95

Revision history

Table 8. Document revision history

Date	Revision	Changes
26-Sep-2016	1	First release.
19-Apr-2018	2	Removed maturity status indication from cover page. The document status is production data. Updated features and applications. Minor text changes

IMPORTANT NOTICE – PLEASE READ CAREFULLY

STMicroelectronics NV and its subsidiaries (“ST”) reserve the right to make changes, corrections, enhancements, modifications, and improvements to ST products and/or to this document at any time without notice. Purchasers should obtain the latest relevant information on ST products before placing orders. ST products are sold pursuant to ST’s terms and conditions of sale in place at the time of order acknowledgement.

Purchasers are solely responsible for the choice, selection, and use of ST products and ST assumes no liability for application assistance or the design of Purchasers’ products.

No license, express or implied, to any intellectual property right is granted by ST herein.

Resale of ST products with provisions different from the information set forth herein shall void any warranty granted by ST for such product.

ST and the ST logo are trademarks of ST. All other product or service names are the property of their respective owners.

Information in this document supersedes and replaces information previously supplied in any prior versions of this document.

© 2018 STMicroelectronics – All rights reserved