

SERIES **F** TOGGLE · PUSHBUTTON · LEVER & ROCKER SWITCHES

UL Standard Listed: Series F all 6A, 125V, 250V A.C. File E58109
C.S.A. Certified: Series F all 6A, 125V, 250V A.C. File LR51097

1 ACTUATORS

Wide choice of levers i.e., standard, large, short long, flatted and locking levers available to meet varying requirements in panel design and applications.

2 LEVER-STOP DEVICE

Toggle lever-stopper is built in to prevent "push-in" when a downward force is applied to the lever.

3 INDIVIDUAL SPRING

Individual spring for each pole is employed to provide stable and reliable contacts.

4 NEW FRAME DESIGN

New frame design assures high insulation and stability.

5 GLASS-FILLED POLYESTER CASE (UL94V-0)

The case is manufactured from UL94V-0 which has excellent heat and arc resistant properties and high insulation resistance. Creepage barriers are featured in all Multipole Switches providing increased creepage between contacts.

6 MOVING CONTACT SUPPORT

Unlike many other switches that rely on the molding to provide support for the moving contact, series F does utilize a unique system to

fulfill this important function, greatly increasing the mechanical life of the switch.

7 TERMINAL PITCH

Spacing between terminals is 0.2" (5.08mm) conforming to ISO standard P/C board hole matrix.

8 GOLD-FLASHED TERMINALS

Available in 6 different configurations such as half-hollow cylindrical, P/C, right angle and wire-wrapping terminals. All gold-flashed to prevent perfectly oxidation and for ease of soldering.

9 MOLDED-IN TERMINAL CONSTRUCTION

Molded-in terminals prevent the ingress of solder flux and contaminants.

10 FINE SILVER CONTACTS

Ensure long life and contact reliability (For option of gold contact, please contact us.)

11 COMMON MOUNTING HEIGHT FROM SP TO 4P

The height of SP to 4P switches is identical enabling various switches to be mounted on the same P/C board.

12 STAINLESS STEEL FRAME

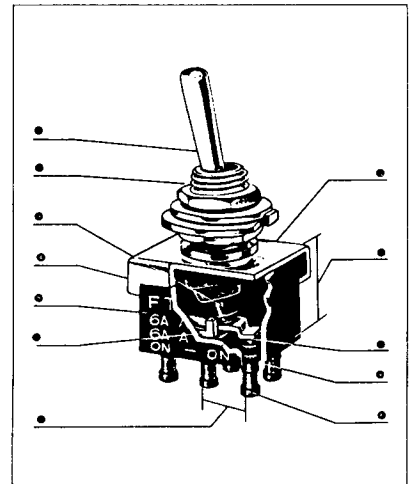

NOTE:

- Special designs are always considered. (O.E.M.)
- Contact Rating 0.4VA 28V DC MAX. is also available with contact and terminal options in Gold.

HOW TO ORDER

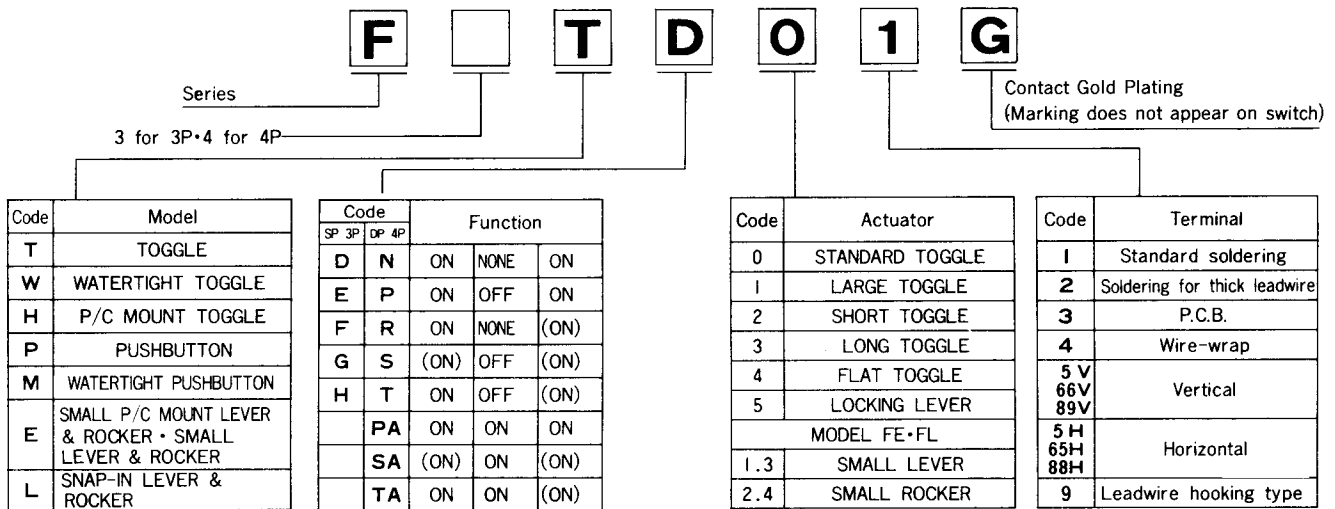

SPECIFICATIONS Series F (all models)

- Contact Rating : 6A 125V A.C. 250V A.C.
- Moisture Resistance : Over 10 Megohms measured after a sample switch remains left for 48 hours under the temperature of 40°C ± 2°C and the relative humidity of 95%.
- Overload : Capable of switching 50 cycles at the rate of 5 times per minute with 150% of the rated current value flowed.
- Electrical Life : 25,000 to 50,000 cycles
- Mechanical Life : 50,000 to 100,000 cycles
- Temperature Rise : Below 30°C at the rated current
- Heat Resistance : No trace of electrical and mechanical defects admitted after a sample switch remains left for 1 hour under the temperature of 150°C ± 3°C.
- Vibration Resistance : No trace of electrical or mechanical defects detectable when applied to vibration force of 600 - 3,300 c/m with the total amplitude of 1.5 mm.
- Shock Resistance : No trace of electrical or mechanical defects detectable when force of 50G is applied to switch mounted on the panel.
- Actuator Strength : No trace of electrical or mechanical defects detectable when force of 4 kg is applied to the actuator.
- Terminal Strength : No trace of electrical or mechanical defects detectable when force of 2.5 kg is applied to the terminal.
- Operating Temperature : -20°C ~ +80°C

SERIES **F** STANDARD TOGGLE · LARGE TOGGLE SWITCHES

● Standard Toggle

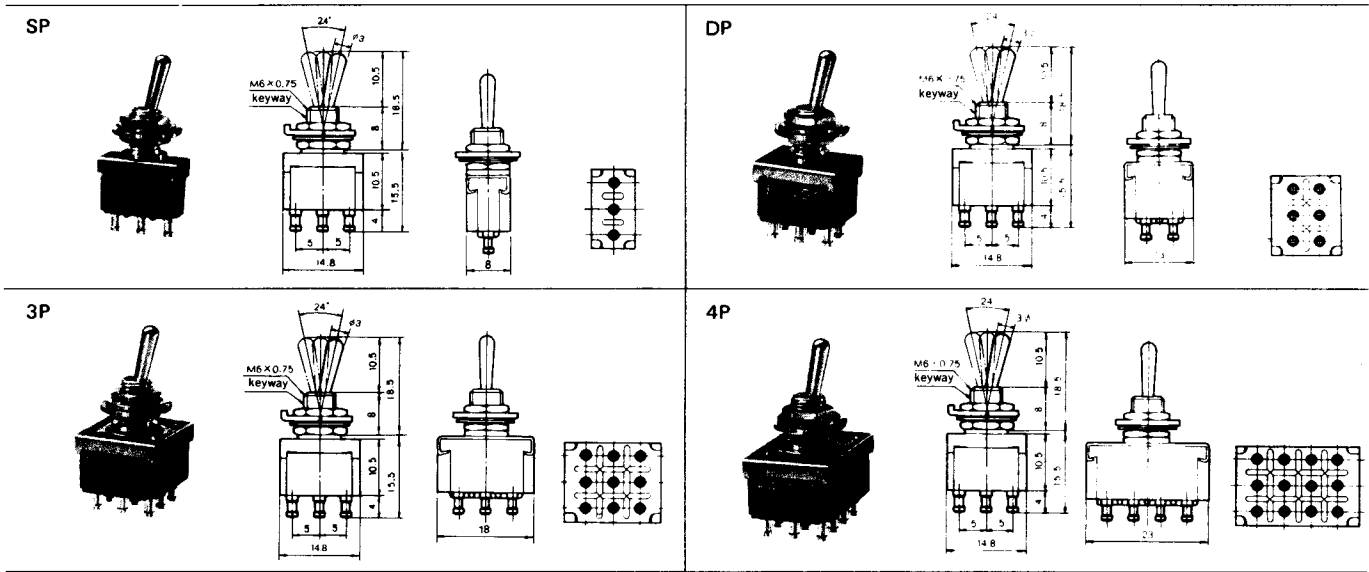

● Mounting Hole Cut-out

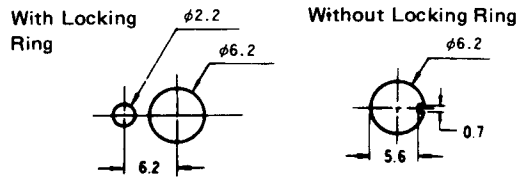

● Mounting Hardware & Accessories

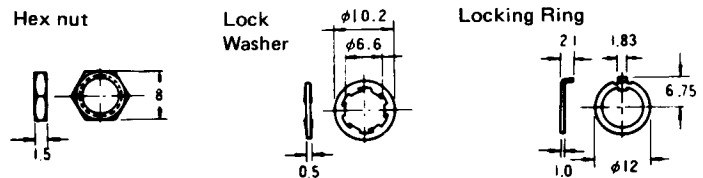

● Large Toggle

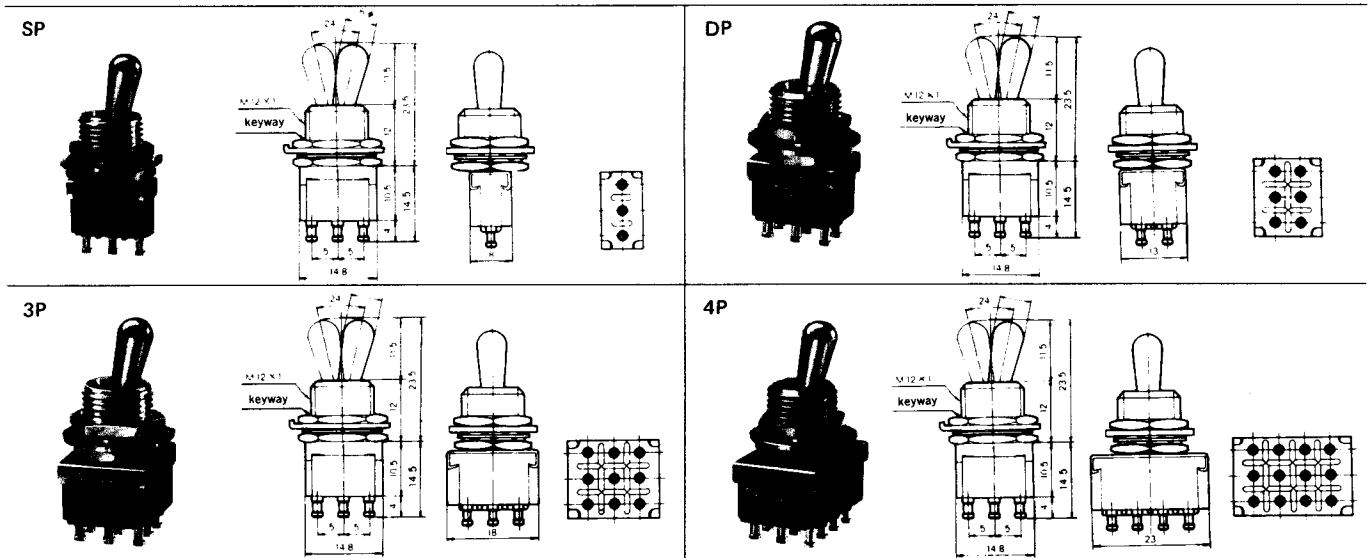

● Mounting Hole Cut-out

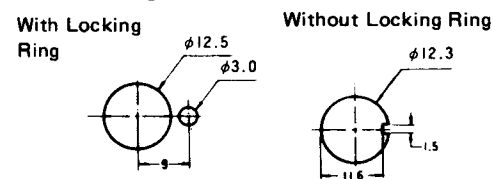

● Mounting Accessories

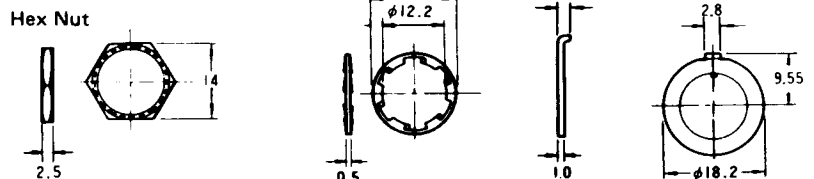

SERIES **F** SHORT TOGGLE · LONG TOGGLE · FLAT TOGGLE SWITCHES

● Short Toggle Switches

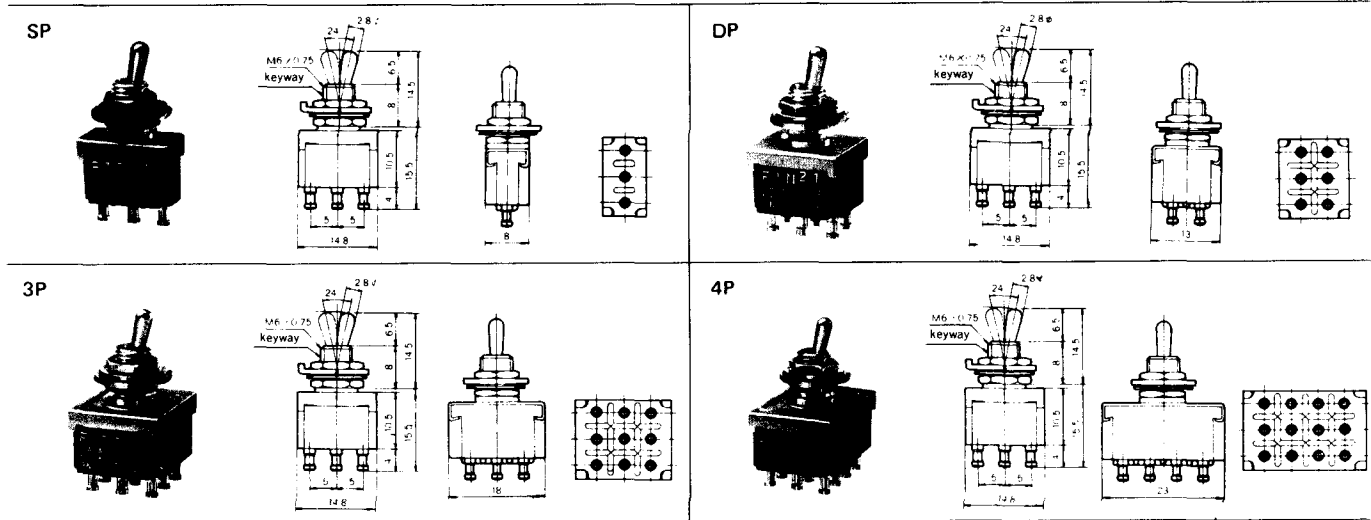

● Long Toggle Switches

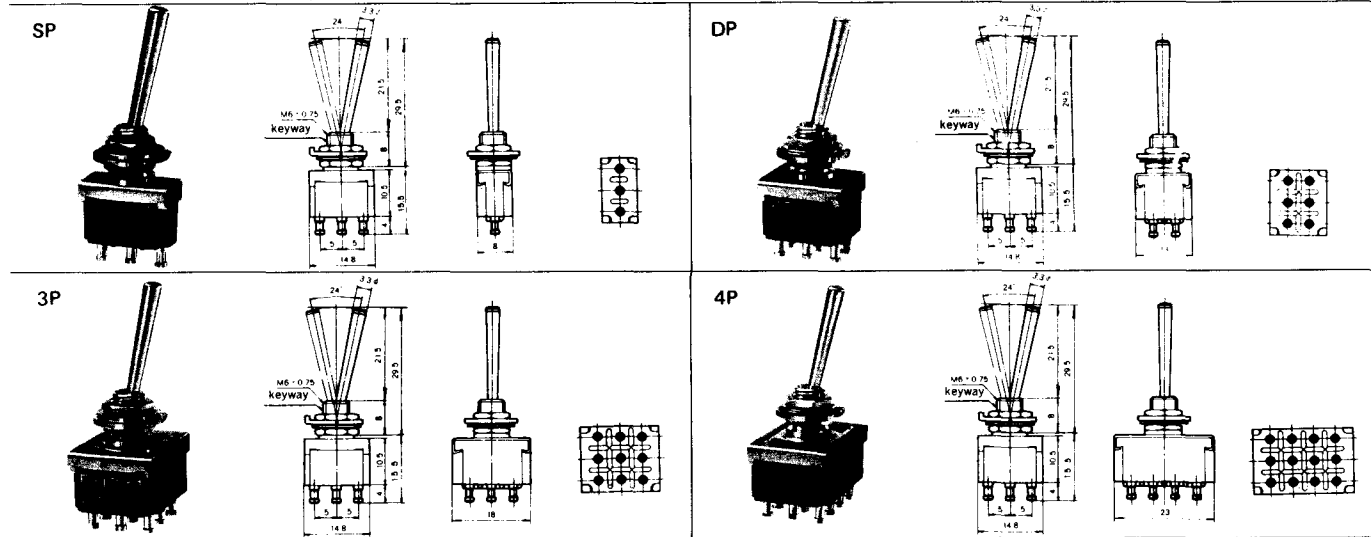

● Flat Toggle Switches

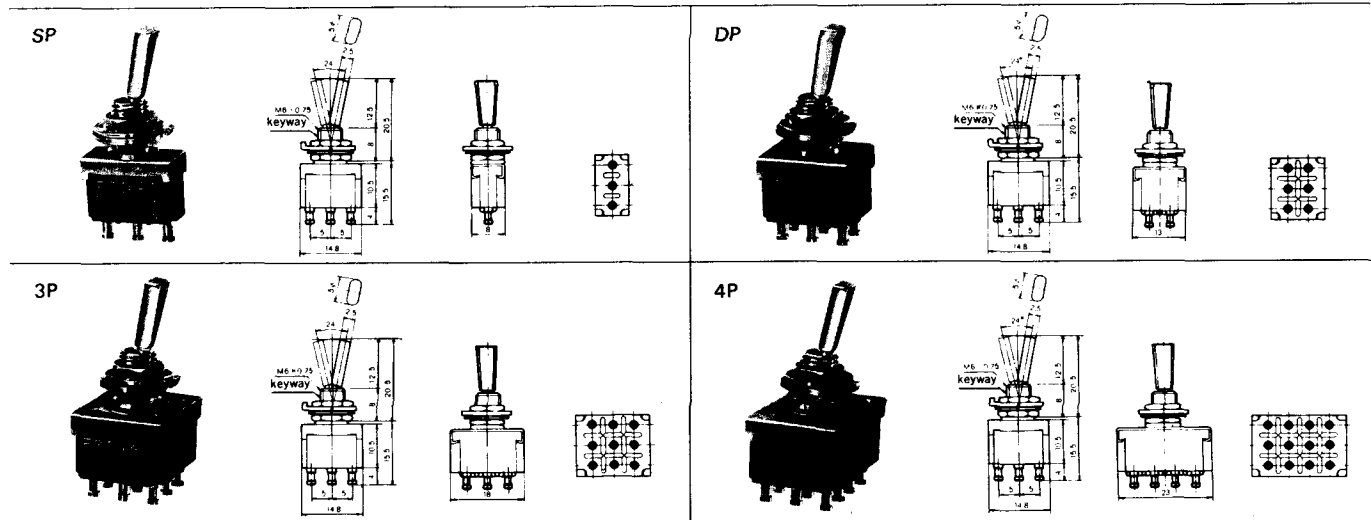

SERIES **F** LOCKING LEVER SWITCHES

FEATURES & OPERATION

The locking lever toggle switch has a special PULL-to-UNLOCK feature with a spring-loaded locking mechanism built in beneath the lever. For operation, the toggle lever must be pulled upward and then it must be locked in place.

Typical applications include such products as measuring instruments, communication equipment, medical equipment, NC equipment, computers, and related peripherals which call for the prevention against accidental switching activation.

● Locking Lever Switches

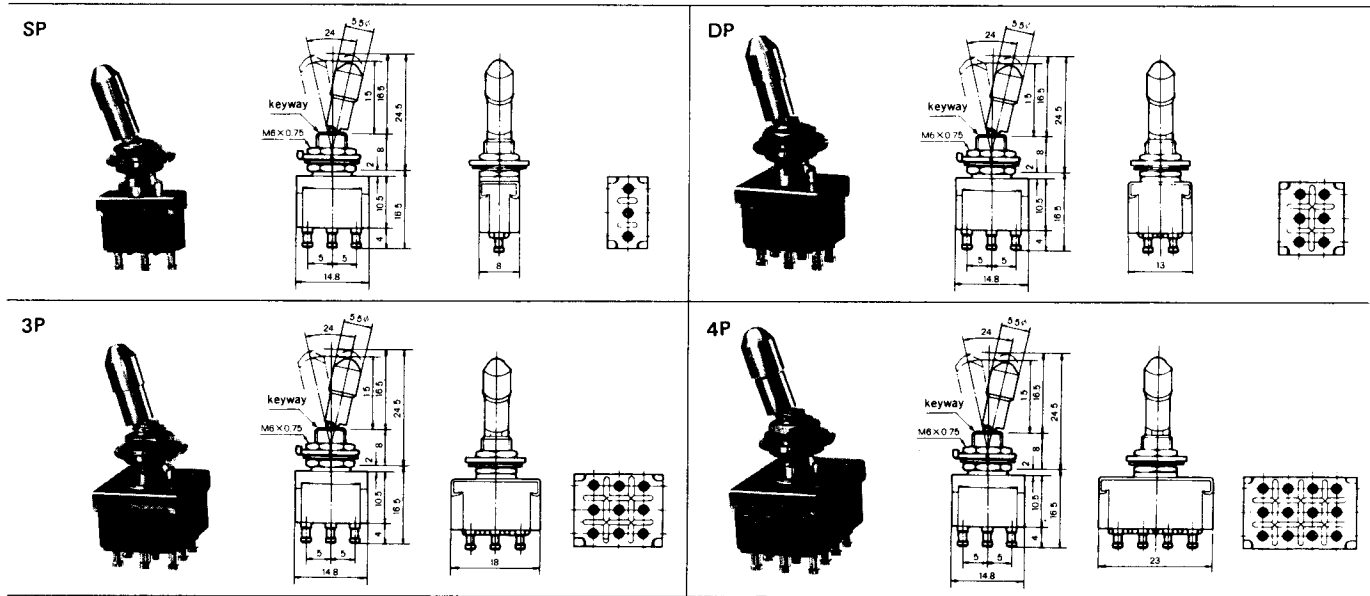

● Locking Lever Cap Shape and Colors

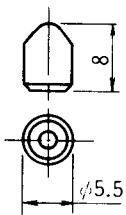

Silver
Black
Red
Blue

Please mention required color for Locking Lever Cap.

FUNCTION	LOCKING CONFIGURATIONS
D.N	keyway
E.P	keyway
F.R	keyway
G.S	keyway
H.T	keyway

● Vinyl Chloride Color Cap for Standard Toggle Switch

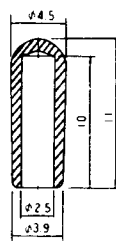

m/m

Code	Color Caps for Toggle Identification
1	White
2	Red
3	Black
4	Blue
5	Yellow
6	Green
7	Pink
8	Grey
9	Orange

SERIES **F** TOGGLE SWITCHES with VERTICAL & HORIZONTAL P.C.B. TERMINALS

● Toggle Switches with Vertical Right Angle P.C. Terminals

● P.C. Hole Pattern

SP

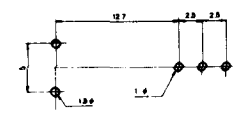
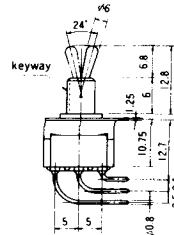
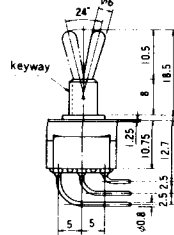
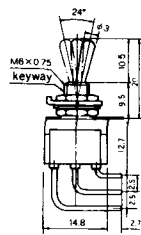

DP

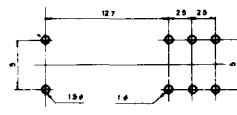
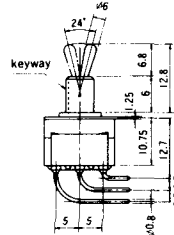
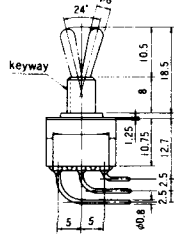
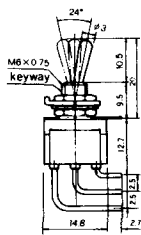

3P

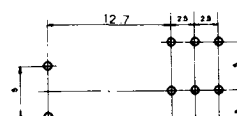
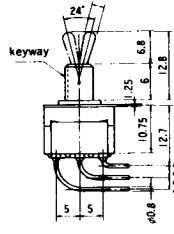
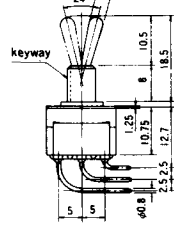
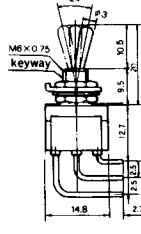

4P

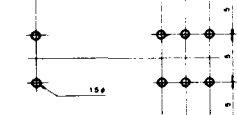
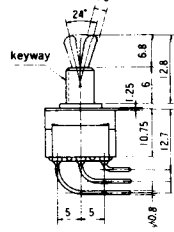
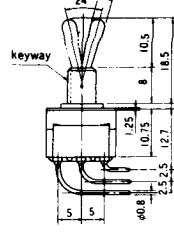
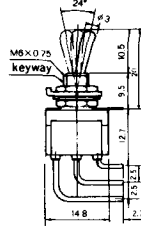

● Toggle Switches with Horizontal Right Angle P.C. Terminals

● P.C. Hole Pattern

SP

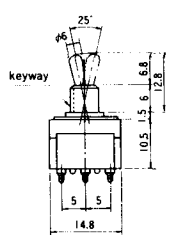
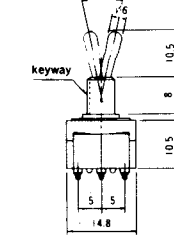
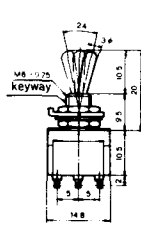

DP

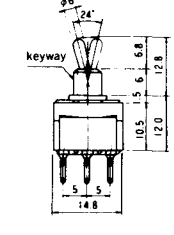
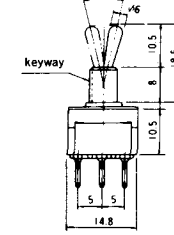
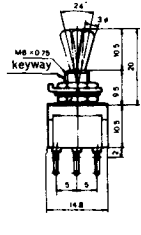

SERIES **F** WATERTIGHT TOGGLE · WATERTIGHT PUSHBUTTON SWITCHES

WATERTIGHT VERSION

The watertight version switch has two "O" rings of Nitril Buna N fitted between the lever, (of toggles or pushbuttons) and bushing, and inside the bushing range to prevent the ingress of water into the switch from the panel surface.

For use in areas of high humidity or where equipment is subjected to spray, etc.

Water-resistant rubber boots are optionally available upon request.

● Watertight Toggle Switches

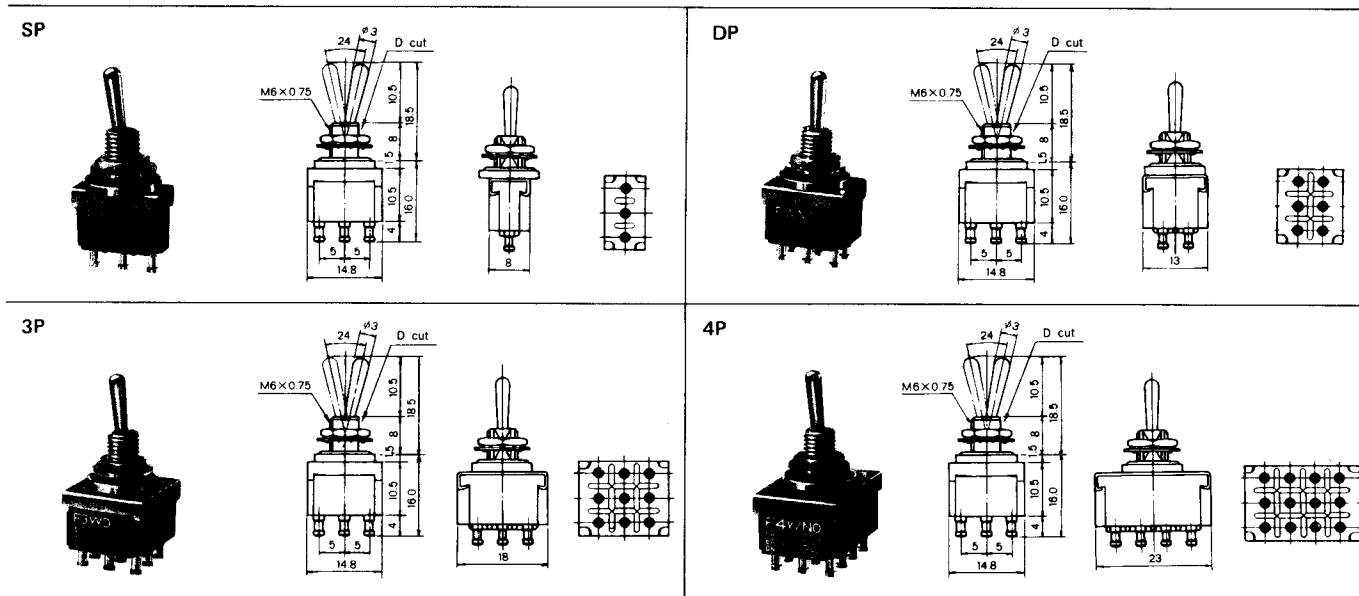

● Watertight Pushbutton Switches

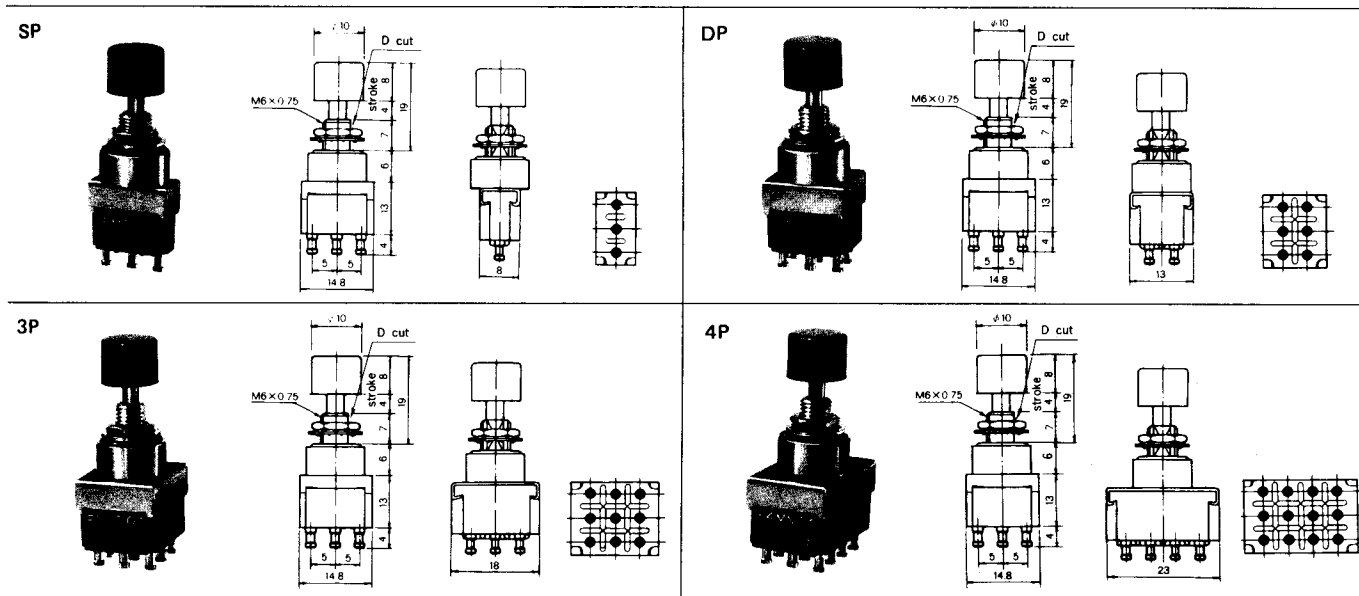



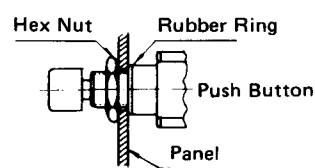
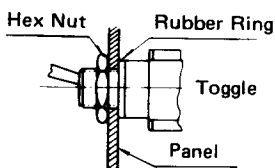
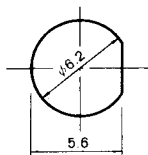





● Mounting Hole Cut-out

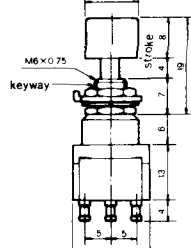

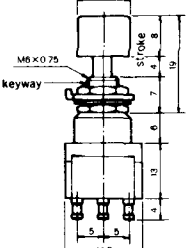
SERIES F STANDARD PUSHBUTTON & LARGE PUSHBUTTON SWITCHES

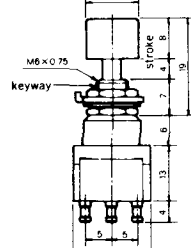
● Standard Pushbutton

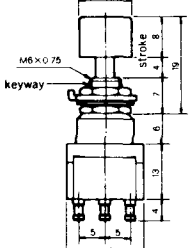
(ON) Indicates Momentary Position.

<p>SP</p> 		<p>Function</p> <p>D ON ON</p> <p>F (ON) ON</p> 	<p>DP</p> 		<p>Function</p> <p>D ON ON</p> <p>F (ON) ON</p> 
<p>3P</p> 		<p>Function</p> <p>D ON ON</p> <p>F (ON) ON</p> 	<p>4P</p> 		<p>Function</p> <p>D ON ON</p> <p>F (ON) ON</p> 

● Mounting Hole Cut-out

● Mounting Hardware & Accessories

With Locking Ring

Without Locking Ring

Hex Nut





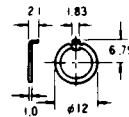
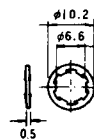
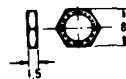
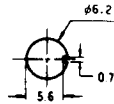
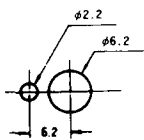

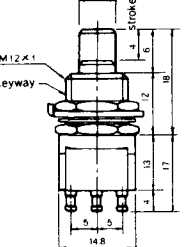

Lockwasher

Locking Ring

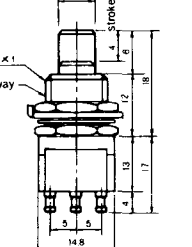

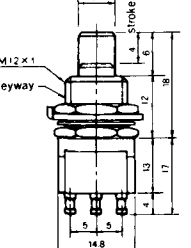
● Large Pushbutton Switches (Splashproof Caps, optionally available.)

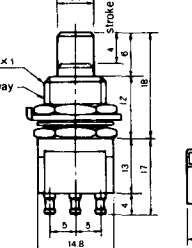
(ON) Indicates Momentary Position.

<p>SP</p> 		<p>Function</p> <p>D ON ON</p> <p>F (ON) ON</p> 	<p>DP</p> 		<p>Function</p> <p>D ON ON</p> <p>F (ON) ON</p> 
<p>3P</p> 		<p>Function</p> <p>D ON ON</p> <p>F (ON) ON</p> 	<p>4P</p> 		<p>Function</p> <p>D ON ON</p> <p>F (ON) ON</p> 

● Mounting Hole Cut-out

● Mounting Hardware & Accessories

With Locking Ring

Without Locking Ring

Hex Nut

Lock Washer

Locking Ring

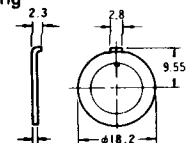
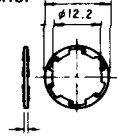
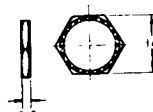
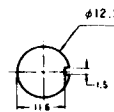
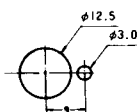

SERIES **F** P.C. B. MOUNT TOGGLE·LEVER & ROCKER SWITCHES

● P.C. Mount Toggle Switches

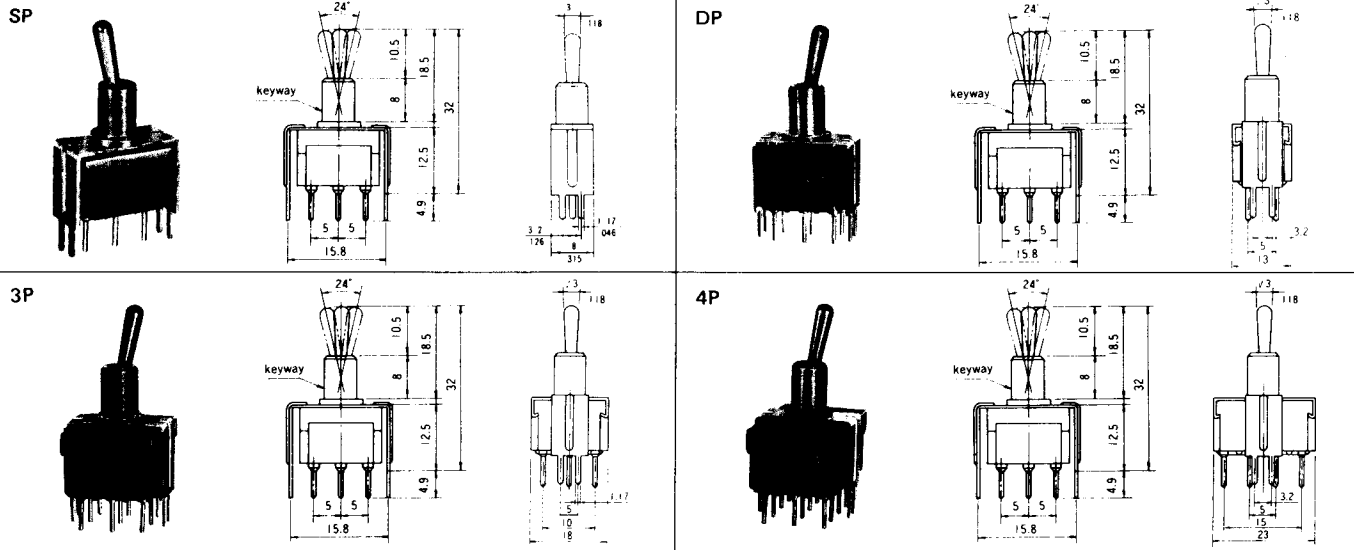

● P.C. Mount Small Lever Switches

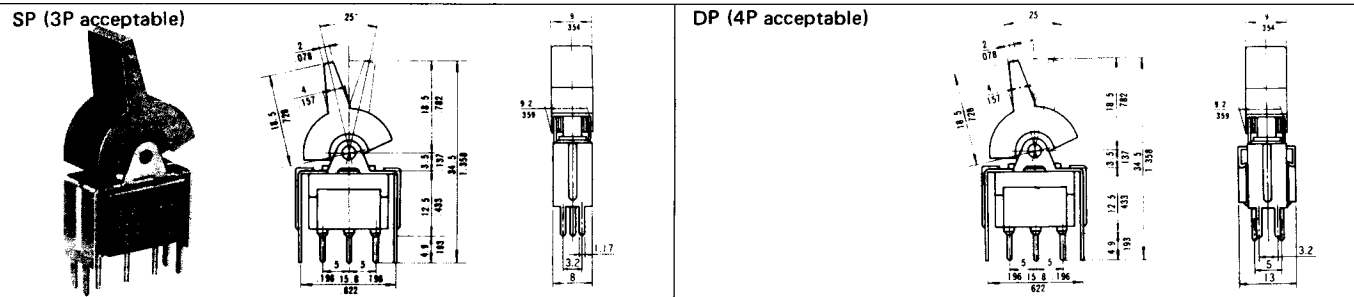

● P.C. Mount Small Rocker Switches

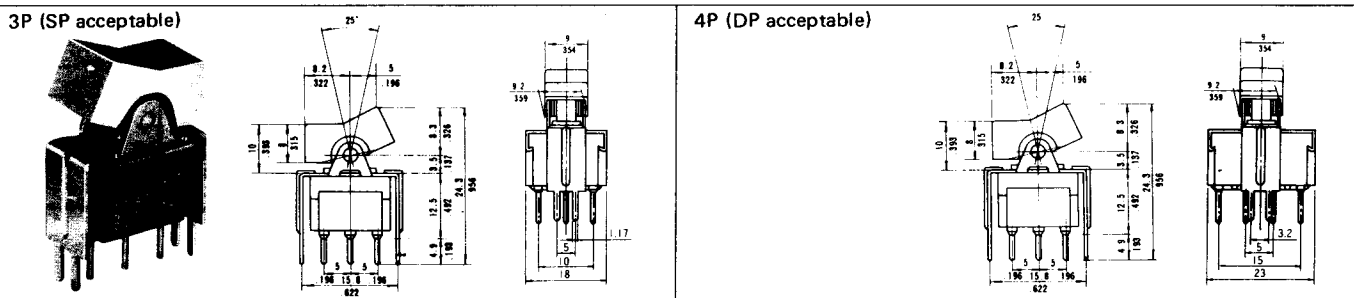

● P.C. Hole Pattern (all models) in mm.

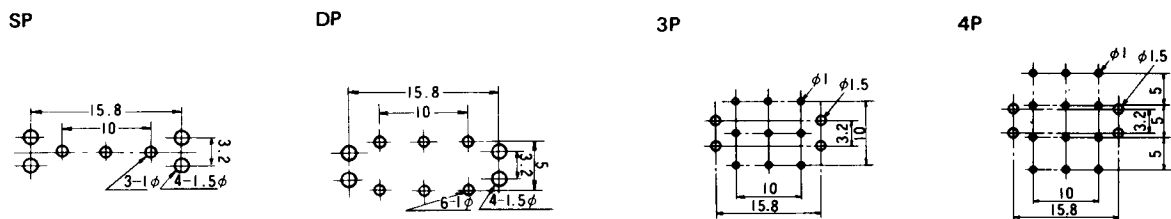

SERIES **F** SMALL LEVER & ROCKER SWITCHES SNAP-IN LEVER & ROCKER SWITCHES

● Small Lever Switches

SP (3P acceptable)

DP (4P acceptable)

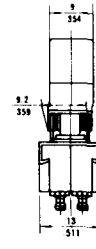
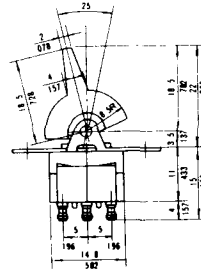
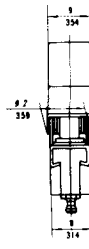
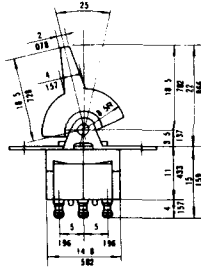
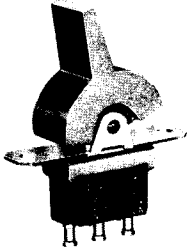

● Mounting Hole Cut-out

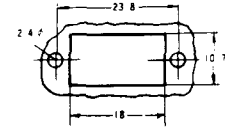

● Small Rocker Switches

3P (SP acceptable)

4P (DP acceptable)

● Mounting Hole Cut-out

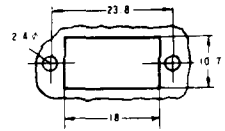
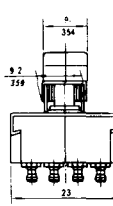
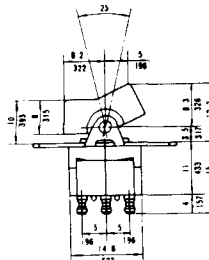
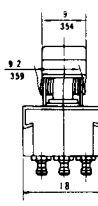
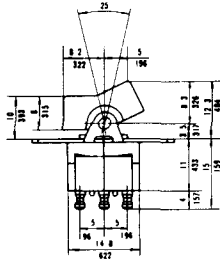
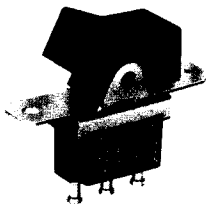

● Snap-in Lever Switches

SP

DP

● Panel Opening

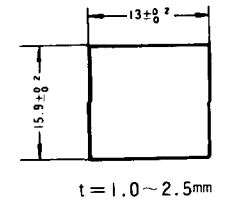
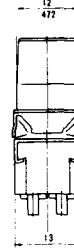
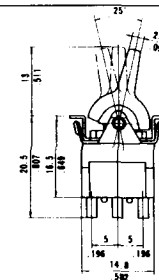
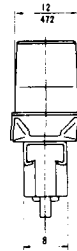
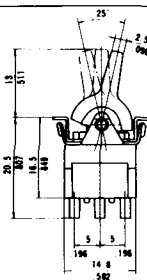

● Snap-in Rocker Switches

SP

DP

● Panel Opening

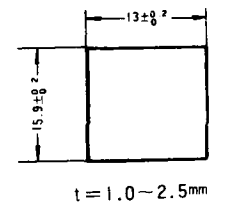
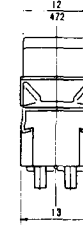
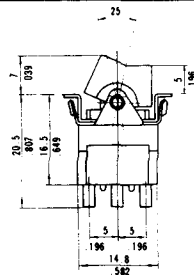
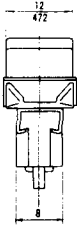
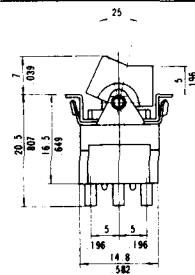

m/m

● Color Actuators

Actuators: Lever & Rocker Switches

1. Lever & Rocker Color (FE & FL models only)

Color	Color Coded	
	Gloss F.	Mat F.
White	01	11
Red	02	12
Black	03	13
Blue	04	14
Yellow	05	15
Green	06	16

Small Lever Switch



Snap-in Lever Switch



Small Rocker Switch



Snap-in Rocker Switch



2. Pushbutton Color (FP & FM models only)

Color	Pushbutton Color Coded	
	φ10	φ15
White	01	11
Red	02	12
Black	03	13
Blue	04	14
Yellow	05	15
Green	06	16

Color Pushbutton

