

BMW65N100UC1

N-Channel Power MOSFET

650 V, 35 A, 100 mΩ

Description

BMW65N100UC1 is power MOSFET using bestirpower' s advanced super junction technology that can realize very low on resistance and gate charge. It will provide much high efficiency by using optimized charge coupling technology. These user friendly devices give an advantage of Low EMI to designers as well as low switching loss.

Applications

- AC/DC power supply.
- PC power.
- Telecom/Sever.
- Solar invertor.

Features

$BV_{DSS} @ T_{J,max}$	I_D	$R_{DS(on),max}$	$Q_{g,typ}$
700 V	35 A	100 mΩ	66 nC

- Ultra-fast body diode.
- Extremely low losses due to very low FOM $R_{dson} * Q_g$ and E_{oss} .
- Very high commutation ruggedness.

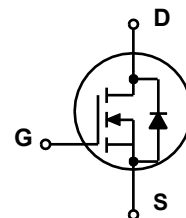
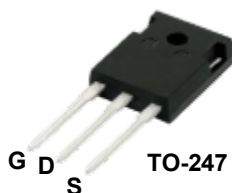

Absolute Maximum Ratings ($T_C = 25^\circ\text{C}$ unless otherwise noted)

Symbol	Parameter	Value max	Unit
V_{DSS}	Drain to Source Voltage(1)	650	V
V_{GSS}	Gate to Source Voltage	± 30	V
I_D	Drain Current(2)	Continuous ($T_C = 25^\circ\text{C}$)	35
		Continuous ($T_C = 125^\circ\text{C}$)	15
I_{DM}	Drain Current	Pulsed	105
E_{AS}	Single Pulsed Avalanche Energy(3)	750	mJ
dv/dt	MOSFET dv/dt ruggedness	50	V/ns
	Peak Diode Recovery dv/dt	50	
P_D	Power Dissipation ($T_C = 25^\circ\text{C}$)	278	W
T_J, T_{STG}	Operating and Storage Temperature Range	-55 to 150	$^\circ\text{C}$
I_S	Continuous diode forward current	35	A
$I_{S \text{ Pulse}}$	Diode pulse current(2)	105	A

1) Limited by T_J max. Maximum duty cycle $D=0.75$.

2) Pulse width t_p limited by T_J,max .

3) $V_{DD}=50\text{V}$, $R_G=25\Omega$, Starting $T_J=25^\circ\text{C}$.

4) $V_{DClink}=400\text{V}$; $V_{DS,peak} < V(BR)_{DSS}$; identical low side and high side switch with identical R_G .

Thermal Characteristics

Symbol	Parameter	Value	Unit
$R_{\theta C}$	Thermal Resistance, Junction to Case, Max.	0.45	$^\circ\text{C/W}$
$R_{\theta A}$	Thermal Resistance, Junction to Ambient, Max.	62	
T_{sold}	Soldering temperature, wavesoldering only allowed at leads	260	$^\circ\text{C}$

Package Marking and Ordering Information

Part Number	Top Marking	Package	Packing Method	Quantity
BMW65N100UC1	BMW65N100UC1	TO247-3	Tube	30 units

Electrical Characteristics (T_C = 25°C unless otherwise noted)

Symbol	Parameter	Test Conditions	Min	Typ	Max	Unit
--------	-----------	-----------------	-----	-----	-----	------

Off Characteristics

BV _{DSS}	Drain to Source Breakdown Voltage	V _{GS} = 0 V, I _D = 1 mA	650	-	-	V
I _{DSS}	Zero Gate Voltage Drain Current	V _{DS} = 650 V, V _{GS} = 0 V	-	-	10	μA
I _{GSS}	Gate-Source Leakage Current	V _{GS} = ±30V, V _{DS} = 0 V	-	-	±100	nA

On Characteristics

V _{GS(th)}	Gate Threshold Voltage	V _{GS} = V _{DS} , I _D = 1 mA	3.5	4.0	4.5	V
R _{DS(on)}	Static Drain to Source On Resistance	V _{GS} = 10 V, I _D = 18A T _J = 25°C	-	82	100	mΩ

Dynamic Characteristics

C _{iss}	Input Capacitance	V _{GS} = 0V, V _{DS} = 50V, f = 250KHz	-	2990	-	pF
C _{oss}	Output Capacitance		-	141	-	pF
C _{rss}	Reverse transfer capacitance		-	5.8	-	pF
C _{o(tr)}	Time Related Output Capacitance ²⁾	V _{DS} = 0 to 400 V, V _{GS} = 0 V	-	452	-	pF
C _{o(er)}	Energy Related Output Capacitance ¹⁾		-	88	-	pF
Q _{g(tot)}	Total Gate Charge at 10 V	V _{DD} = 400 V, I _D = 18A, V _{GS} = 0 to 10 V	-	66	-	nC
Q _{gs}	Gate to Source Charge		-	20	-	nC
Q _{gd}	Gate to Drain "Miller" Charge		-	25	-	nC
V _{plateau}	Gate plateau voltage		-	6.1	-	V
R _G	Gate Resistance	f = 1 MHz	-	2.7	-	Ω
t _{d(on)}	Turn-On Delay Time	V _{DD} = 400 V, I _D = 18A, V _{GS} = 10 V,	-	21	-	ns
t _r	Turn-On Rise Time		-	19	-	ns
t _{d(off)}	Turn-Off Delay Time		-	76	-	ns
t _f	Turn-Off Fall Time		-	8	-	ns

Source-Drain Diode Characteristics

V _{SD}	Diode Forward Voltage	V _{GS} = 0 V, I _F = 18A T _f = 25°C	-	0.88	-	V
t _{rr}	Reverse Recovery Time	V _R = 400 V, I _F = 18 A, di _F /dt = 100 A/μs	-	140	-	ns
Q _{rr}	Reverse Recovery Charge		-	1.15	-	μC
I _{mm}	Peak reverse recovery current		-	15	-	A

1) Co(er) is a fixed capacitance that gives the same stored energy as Coss while VDS is rising from 0 to 400V.

2) Co(tr) is a fixed capacitance that gives the same charging time as Coss while VDS is rising from 0 to 400V.

Typical Performance Characteristics

Figure 1. Power dissipation

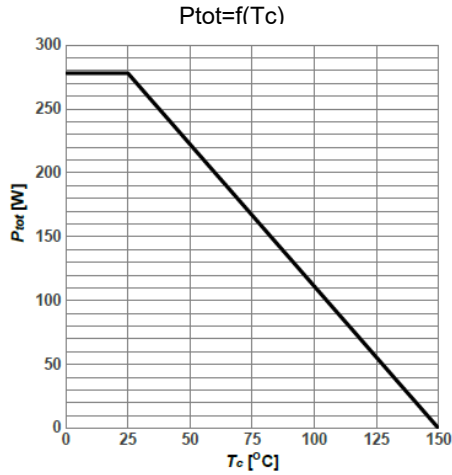

Figure 2: Max. transient thermal impedance

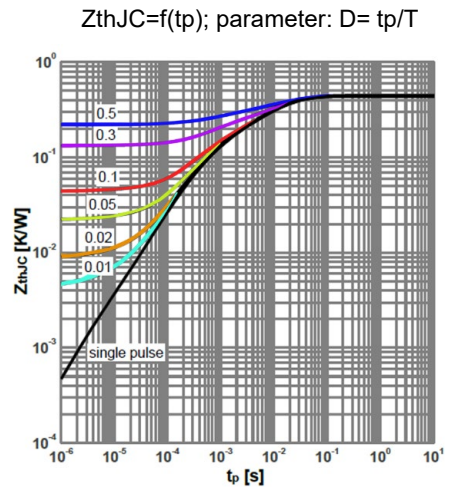

Figure 3: Safe operating area

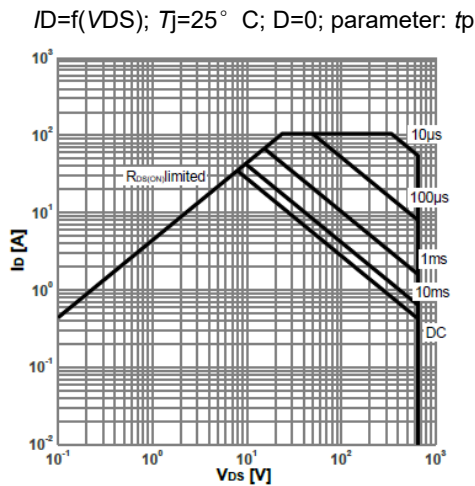

Figure 4: Typ. output characteristics

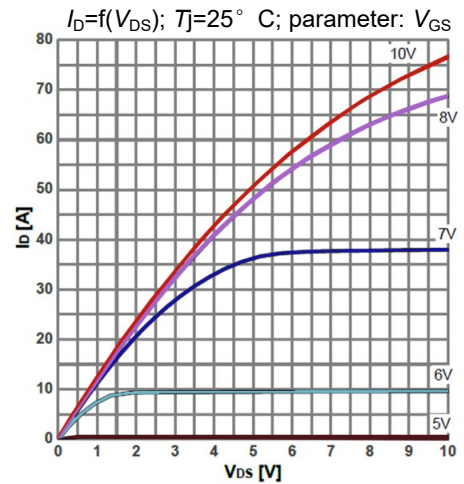

Figure 5: Typ. output characteristics

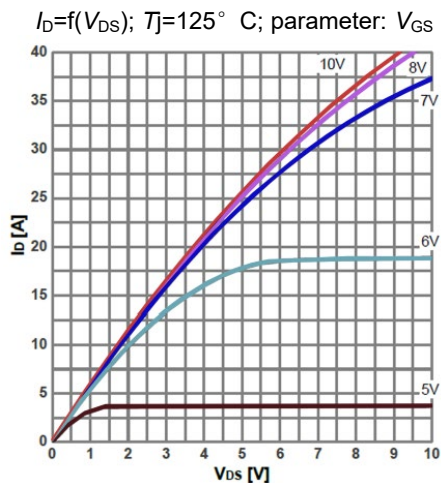
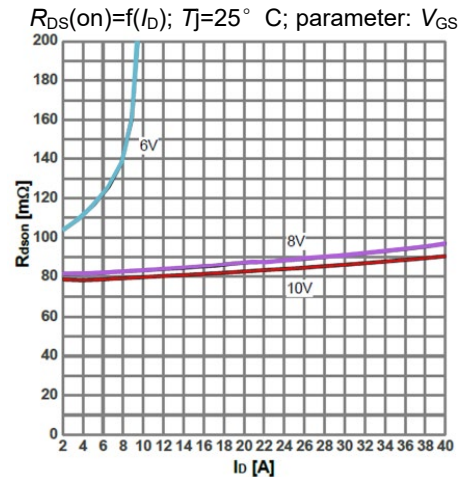

Figure 6: Typ. drain-source on-state resistance



Typical Performance Characteristics

Figure 7: Drain-source on-state resistance

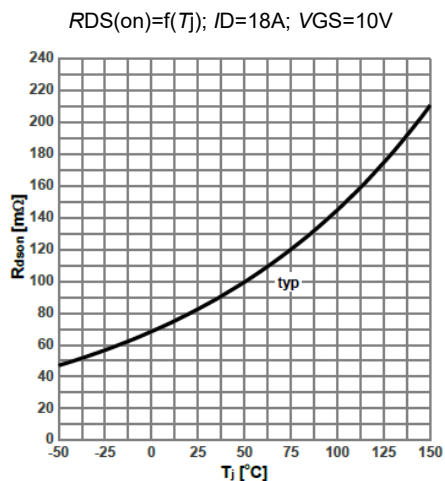

Figure 8: Typ. transfer characteristics

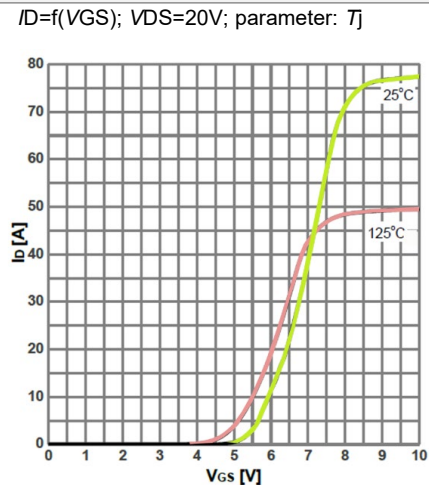

Figure 9: Typ. gate charge

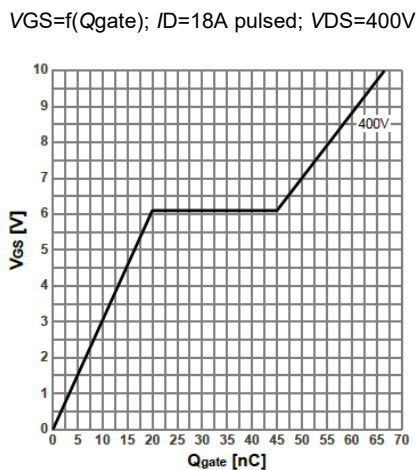

Figure 10: Forward characteristics of reverse diode

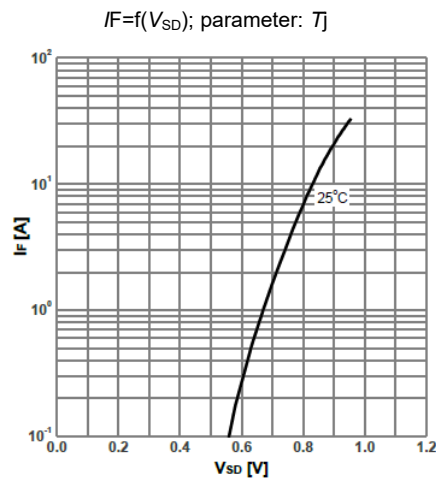

Figure 11: Drain-source breakdown voltage

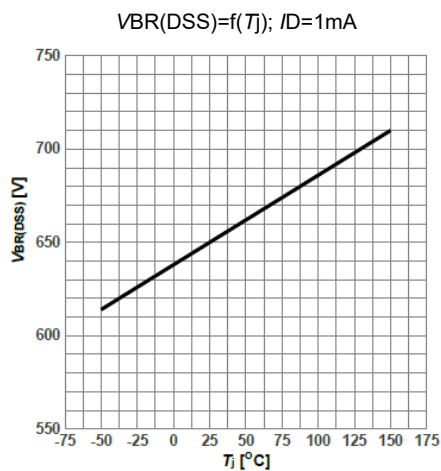
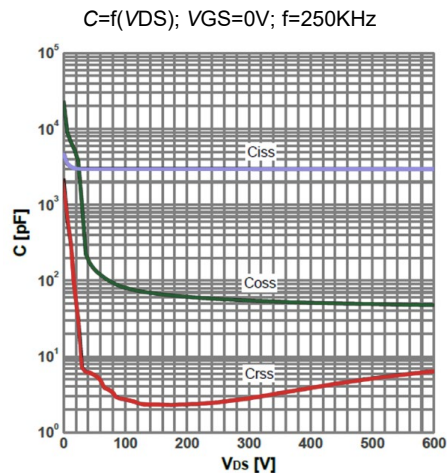

Figure 12: Typ. capacitances



Typical Performance Characteristics

Figure 13: Typ. Coss stored energy

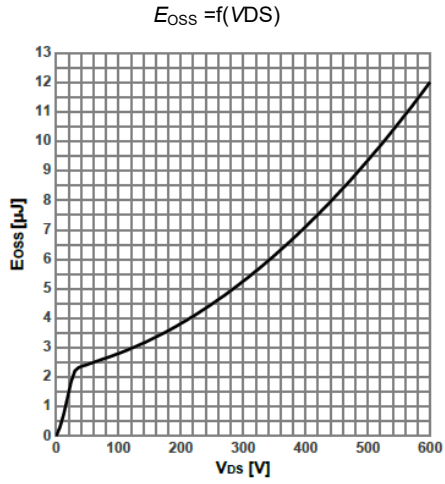
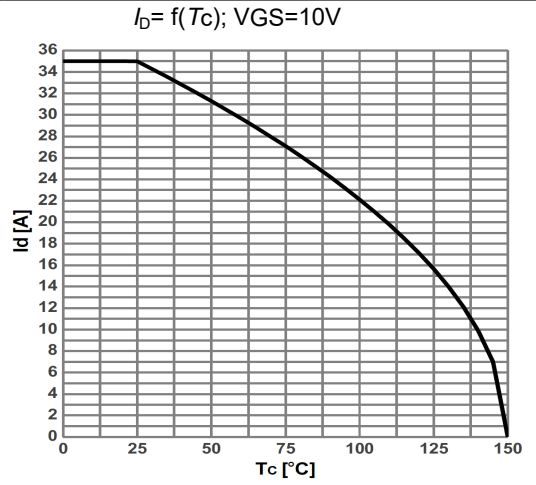
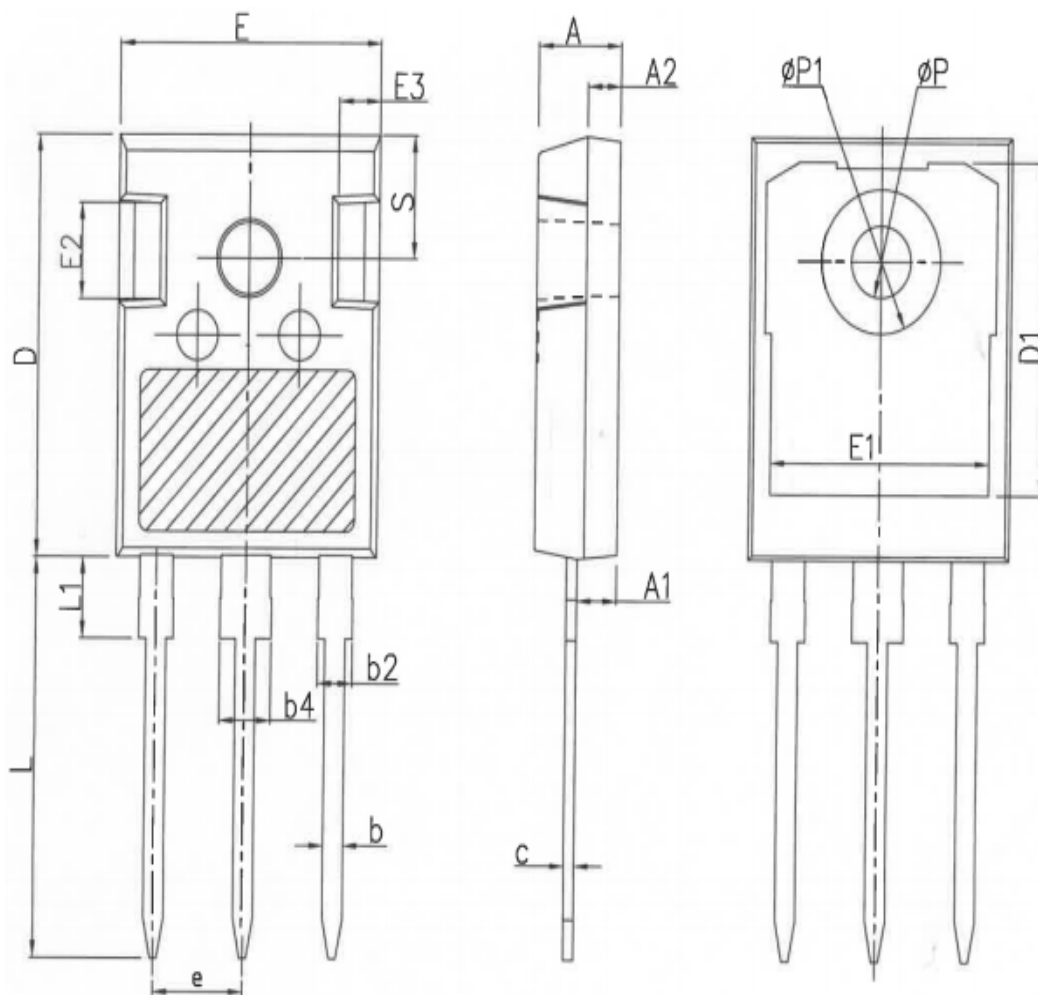

Figure 14: Max. Drain Current



Package Outlines

TO247-3



COMMON DIMENSIONS

SYMBOL	mm		
	MIN	NOM	MAX
A	4.80	5.00	5.20
A1	2.21	2.41	2.59
A2	1.85	2.00	2.15
b	1.11	1.21	1.36
b2	1.91	2.01	2.21
b4	2.91	3.01	3.21
c	0.51	0.61	0.75
D	20.70	21.00	21.30
D1	16.25	16.55	16.85
E	15.50	15.80	16.10
E1	13.00	13.30	13.60
E2	4.80	5.00	5.20
E3	2.30	2.50	2.70
e	5.44BSC		
L	19.62	19.92	20.22
L1	-	-	4.30
ΦP	3.40	3.60	3.80
ΦP1	-	-	7.30
S	6.15BSC		

* Dimensions in millimeters

Disclaimer

Bestirpower reserve the right to make changes, corrections, enhancements, modifications, and improvements to Bestirpower products and/or to this document at any time without notice.

The information given in this document shall in no event be regarded as a guarantee of conditions or characteristics. Bestirpower does not assume any liability for infringement of patents, copyrights, or other intellectual property rights of third parties by or arising from the use of Products or technical information described in this document.

This document is the property of Bestirpower Co., LTD., and not allowed to copy or transformed to other format if not under the authority approval.

© 2024 bestirpower – All rights Reserved