

LQW18ASR27G00#

“#” at the end indicates the package specification code.

Designed under Industrial Global Standard



< List of part numbers with package codes >

LQW18ASR27G00B LQW18ASR27G00D LQW18ASR27G00J

Applications

| | |
|--------------------------|---|
| Unsuitable Applications | Please be sure to read and comply with these "Precautions for use." |
| Specific Applications | Consumer equipment, Medical equipment [GHTF A/B/C] except for implant & surgery & auto injector, Industrial equipment except for transportation & facility & energy equipment Please refer to Our Website and specifications, etc. for information about the performance, functions, quality, management, and safety required for the above applications, and use Products after confirming the performance and reliability of the actual Product. |
| Recommended Applications | Consumer equipment |

Appearance & Shape

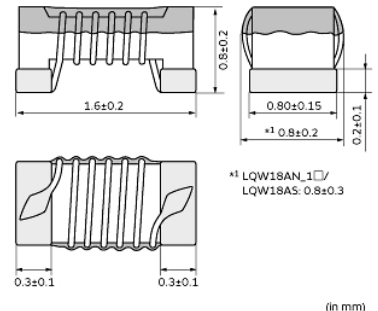
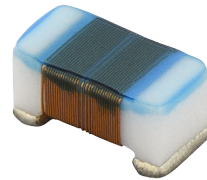

Attention
1. This datasheet is downloaded from the website of Murata Manufacturing Co., Ltd. Therefore, its specifications are subject to change or our products in it may be discontinued without advance notice. Please check with our sales representatives or product engineers before ordering.
2. This datasheet has only typical specifications because there is no space for detailed specifications.
Therefore, please review our product specifications or consult the approval sheet for product specifications before ordering.

LQW18ASR27G00#

“#” at the end indicates the package specification code.



References

| Packaging | Specifications | Standard Packing Quantity |
|-----------|------------------|---------------------------|
| B | Bulk(Bag) | 500 |
| D | 180mm Paper Tape | 4000 |
| J | 330mm Paper Tape | 10000 |

| Mass (typ.) | |
|-------------|--------|
| 1 piece | 0.003g |

Attention

- 1.This datasheet is downloaded from the website of Murata Manufacturing Co., Ltd. Therefore, it's specifications are subject to change or our products in it may be discontinued without advance notice. Please check with our sales representatives or product engineers before ordering.
- 2.This datasheet has only typical specifications because there is no space for detailed specifications.
Therefore, please review our product specifications or consult the approval sheet for product specifications before ordering.

LQW18ASR27G00#

“#” at the end indicates the package specification code.



Specifications

| | |
|---|----------------|
| L size | 1.6±0.2mm |
| W size | 0.8±0.3mm |
| T size | 0.8±0.2mm |
| Size code inch (mm) | 0603 (1608) |
| Inductance | 270nH±2% |
| Inductance Test Frequency | 100MHz |
| Rated current (Itemp) (Based on Temperature rise) | 170mA |
| Max. of DC resistance | 2.3Ω |
| Operating Temperature Range (Self-temperature rise is included) | -40°C to 125°C |
| Class of magnetic shield | Non-Shielded |
| Q(min.) | 24 |
| Q Test Frequency | 100MHz |
| Self resonance frequency (min.) | 900MHz |
| Brand | Murata |
| Series | LQW18AS_00 |

Attention

- 1.This datasheet is downloaded from the website of Murata Manufacturing Co., Ltd. Therefore, it's specifications are subject to change or our products in it may be discontinued without advance notice. Please check with our sales representatives or product engineers before ordering.
- 2.This datasheet has only typical specifications because there is no space for detailed specifications.
Therefore, please review our product specifications or consult the approval sheet for product specifications before ordering.

LQW18ASR27G00#

“#” at the end indicates the package specification code.



Characteristic Data

The charts below may show another part number which shares its characteristics.

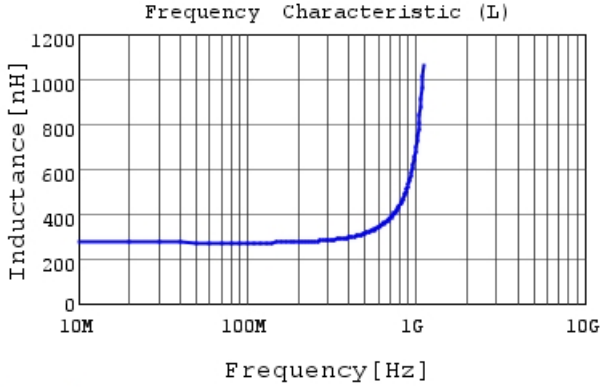

LQW18ASR27G00 L

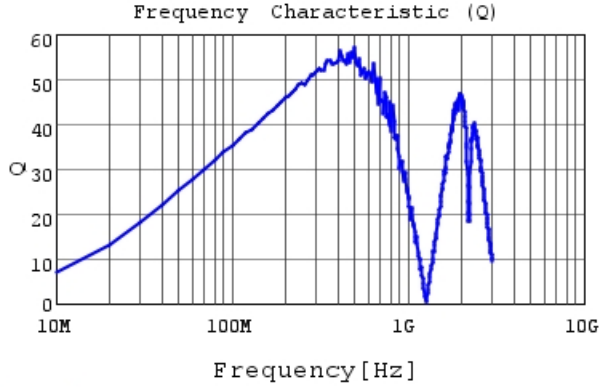

LQW18ASR27G00 Q

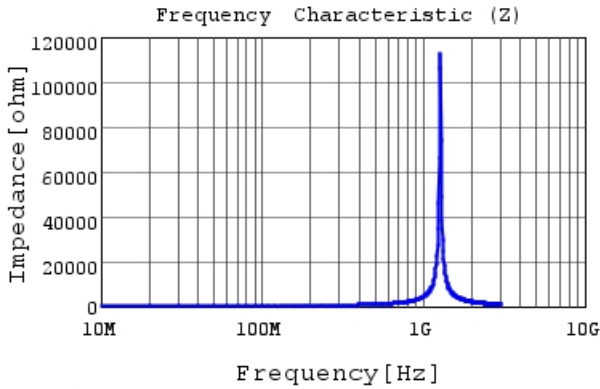

LQW18ASR27G00 |Z|

Attention

- 1.This datasheet is downloaded from the website of Murata Manufacturing Co., Ltd. Therefore, it's specifications are subject to change or our products in it may be discontinued without advance notice. Please check with our sales representatives or product engineers before ordering.
- 2.This datasheet has only typical specifications because there is no space for detailed specifications.
Therefore, please review our product specifications or consult the approval sheet for product specifications before ordering.