Tinymesh™ RF Transceiver Modules

Product Description

The RC11XX(HP) / RC25XX(HP) / RC17xx(HP)-TM RF Transceiver Modules are compact surface-mounted high performance modules for wireless mesh networking applications. The modules feature a fully embedded Tinymesh™ application and multi-hop protocol stack with automatic network forming and self-healing features. The embedded Tinymesh™ application layer supports a full duplex UART, Analogue- Pulse- and Digital inputs, as well as PWM and Digital outputs. Serial application data entered on the UART port is transported automatically to the desired destination node without further interaction from any external processor. The modules are completely shielded, available as Low Power, High Power and Long Range Ultra Narrow Band versions, and pre-certified for operation in license free bands from 169 MHz to 2.4 GHz.

Typical Applications

- Wireless Sensor Networks
- Automatic Meter Reading
- Alarm- and Security Systems
- Building Management
- Telemetry Stations
- Fleet Management
- Asset Tracking
- Street Light Control and Monitoring



Key Features

- Embedded application layer for I/O control and data collection
- Self-forming, self-healing and self-optimizing bi-directional mesh network stack
- AES 128 encryption
- Selectable Gateway, Router and low power End Device configuration
- Configurable digital I/O, PWM (Dimmer) output and analogue inputs
- Full Duplex Serial Port with handshake, streaming support and 256-byte buffer for easy RS232/422/485 wire replacement and MODBUS RTU compatibility
- Pulse counter with configurable de-bounce time and detection feedback output
- 'Walk-by' mode for low power data logging and metering applications
- RSSI and Network connect LED output control for simplified field installation
- Group-, Broadcast- or Individual addressing modes
- Clustered Node Detection and Network Congestion Avoidance (CND/NCA™)
- RF Jamming Detection and Alarm, with alarm output and network alarm messaging
- Analogue- and Digital level triggered event messages.
- Time-generated and event-triggered status messages
- Locator Function for asset tracking applications
- Network Busy Detection for ad hoc networks with multiple, roaming Gateway Devices
- Multiple Gateway support for redundancy and automatic network load sharing
- Small size (12.7 x 25.4 x 3.7 mm), shielded and optimized for SMD mounting
- No external components
- Wide supply voltage range
- RC1x40/80(HP)-TM conforms with EU RED directive (EN 300 220, EN 301 489, EN 60950)
- RC119x-TM conforms with regulations for operation under FCC CFR 47 part 15
- RC117x(HP)-TM complies with G.S.R.564(E) (G.S.R.168(E)).
- RC2500(HP)-TM complies with EN 300 328 (Europe), FCC CFR 47 part 15 (US) and ARIB STD-T66 (Japan)
- RC117x-TM and RC117xHP-TM comply to IEEE 802.15.4.g PHY mode 0 encoding when configured for RF Data Rate 8.

Quick Reference Data

Module version LP HP Long Range, UNB-HP	RC1701HP-TM	RC114x ¹ -TM RC1740HP-TM	RC1760HP-TM	RC117x ¹ -TM RC117xHP ² -TM	RC118x-TM ¹ RC118xHP-TM ¹	RC119x-TM ¹ RC119xHP-TM ¹	RC2500-TM RC2500HP-TM	Unit
Frequency LP HP UNB-HP	169	433 - 434 424 - 447	458-468	865 - 867 865 - 867	868 - 870 868 - 870 865 - 870	902- 927 902- 927	2400 - 2483 2400 - 2483	MHz
Channels LP HP UNB-HP	13	17 173	239	15 15	18 18 94	50 50	83 83	
Data rate LP HP UNB-HP	0.3-100	1.2 - 100 0.3-100	0.3-100	1.2 - 100 1.2 - 100	1.2 - 100 1.2 - 100 0.3 - 100	1.2 - 250 1.2 - 250	1.2 - 250 1.2 - 250	kbit/s
Max TX power LP HP UNB/UNB-HP	27	11 14/27	14/27	11 27	11 27 14/27	11 27	1 18	dBm
Sensitivity 1.2/ 100 kbit/s LP HP UNB-HP	-118 / -102	-110 / -97 -118 / -102	-118 / -102	-110 / -97 -109 / -96	-110 / -97 -109 / -96 -118 / -102	-110 / -97 -109 / -96	-105 / -89 -108/ -91	dBm
Supply voltage LP HP UNB-HP	2.8 - 3.6	2.0 - 3.6 2.8 - 3.6	2.8 - 3.6	2.0 - 3.6 3.0 - 3.3	2.0 - 3.6 3.0 - 3.3 2.8 - 3.6	2.0 - 3.6 3.0 - 3.3	2.0 - 3.6 2.7 - 3.6	Volt
RX/ TX Current LP HP UNB-HP	31/ 407	24 / 35 31/ 318+63	31/ 297+72	24 / 37 24 / 560	24 / 37 24 / 560 31/ 297+72	24 / 37 24 / 560	25 / 27 30 / 155	mA
SLEEP Current LP HP UNB-HP	0.6	0.3 0.6	0.6	0.3 3.4	0.3 3.4 0.6	0.3 3.4	0.4 1.3	uA
Temp. range LP HP UNB-HP	-30 to +85	-40 to +85 -30 to +85	-30 to +85	-40 to +85 -40 to +85	-40 to +85 -40 to +85 -30 to +85	-40 to +85 -40 to +85	-40 to +85 -20 to +85	°C

Typical Application Circuit



Please see additional schematic information regarding recommended Reset and Power supply filtering, LED outputs, configurable I/O pins and how to include a firmware upgrade connector later in this document.

¹ Radiocrafts will deliver RC11x0-TM or RC11x1-TM and RC11x0HP-TM or RC11x1HP-TM depending on availability. The versions performance is identical.

Table of Contents

Product Description	1
Typical Applications	1
Key Features	1
Quick Reference Data	2
Typical Application Circuit	2
Table of Contents	3
Tinymesh™ Application and Protocol Stack	6
Tinymesh™ Devices	6
Gateway Device	6
Router Device	7
End Device	7
Data Integrity	7
Network Formation	7
Self-healing	7
Self-optimizing	8
Network Addressing	8
Multiple Gateway Support	8
Ad Hoc Networks and Hand Held Gateway Devices	9
Alerts and Device Triggered Events	9
Over the Air Configuration	9
Getting Started	10
How do I Form a Network?	10
How do I Transmit Data?	10
How do I Receive Data?	10
What about the Antenna?	11
How do I change the RF Channel or any other Parameter?	11
Module Pin Assignment	12
Pin Description, RC11xx(HP)/ RC25xx(HP) Devices	12
Pin Description, RC17xx Devices	14
Circuit Description	16
Selecting the Right Module for Your Application	16
Indicative Module Selection Guide	17
RCTools	17
Transparent Mode Operation	18
Transparent- Versus Packet- Mode Operation	18
Transparent- and Packet Mode Functions	19
Serial Data Streaming	19
Serial Port Handshake	19
AES Encryption	20
Co-Existence with AES Encrypted and Un-Encrypted Devices	21
Sleep Mode	21
RF Jamming Detection and Alarm	22
RF Jamming Detection in Packet Mode Systems	22
Clustered Node Detection and Network Congestion Avoidance (CND/NCA™)	22
Optimizing Polled Systems	23
LED Indicators	24
LED Indicator Time-Out	24
Pulse Counter Feedback Indicator	24
RSSI Indicator LED	24
Connection Indicator LED	25
Radio RX /TX Indicator LED	25
Configuration mode indicator	25
Packet Mode Operation	26
Gateway in Packet Mode	26
Router in Packet Mode	26
Transmitting Command and Configuration Packets from Gateway	26
Group and Broadcast Addressing	26
Command Acknowledge	27
Command Packet Format	27
Transmit Serial Data Packet from Gateway	28

Received Packet Formats	29
Practical Use of Packet Header Data	31
Device and Network Status Interrogation	31
Serial Data Block Counter	32
Locator Function	32
Network Busy Detection	33
Network ID	33
IMA On Connect Function	33
Automatic Status Reporting	33
Receive Neighbour Function	34
Input / Output Functions	35
Digital Input	35
Digital Input De-bouncing	35
Digital Input 'Trig Hold'	35
Pulse Counter	35
Pulse Counter De-bounce	36
Pulse Count Verification	36
Digital Output control	37
Set Output Comand	37
Toggle Output Command	37
Digital Output Drive	38
PWM (Dimmer) Output	38
Analogue Input	38
Analogue Input Event Triggering	39
Setting the Analogue Input Trigger Level	39
Setting the Analogue Input Sampling Interval.	39
End Device	40
Wake Up from Pulse Counter	40
Wake Up from Digital Input	41
Wake Up from Serial Port UART	41
Wake Up from IMA Timer	41
Battery Lifetime Considerations	41
Analogue Port Sampling by End Devices	42
Module Awake Output Function	42
Fixed Destination and "Walk By" Mode	42
Receive and Transmit Timing	44
Receive RF Packet Timing	44
UART Receive and CTS Timing	45
Memory Configuration Timing	46
RF Frequencies, Output Power and Data Rates	47
Module Configuration	52
Configuration Commands	52
Configuration Mode	52
RSSI Reading (S- Command)	54
Temperature Reading (U- Command)	54
Power Supply Voltage Reading (V- Command)	54
Set Configuration Memory (M- Command)	54
Set Sleep Mode (Z-Command)	55
Alternate Set Sleep Mode (z-Command)	55
Setting and Changing the AES key (K7- Command)	55
Change Calibration Memory Command (HW- Command)	56
Calibrating the Temperature Sensor	56
Setting and Changing the Network ID (NID)	57
Setting and Changing the Fixed Destination ID (FDID)	57
RSSI Sniffer (Test Mode 5)	58
Simple Packet Sniffer (Test Mode 6)	58
Configuration Memory	60
Calibration Memory	66
Demo Board Exercises	67
Transparent Mode Communication	67
Packet Mode Serial Communication, Test and Demo	68
Packet Mode Demo: Digital Output Control, PWM Dimming and Input Trigger	69
End Device Test and Demo, Pulse Counter with Feedback	71
Antenna Connection	72

PCB Layout Recommendations	73
Mechanical Drawings	74
Mechanical drawing, RC11xx / RC25xx	74
Mechanical drawing, RC11xxHP / RC25xxHP	74
Mechanical drawing, RC17xx(HP)	75
Mechanical Dimensions	75
Carrier Tape and Reel Specification	75
Soldering Profile Recommendation	75
Cleaning and welding Recommendation	75
Absolute Maximum Ratings	76
Electrical Specifications	77
Regulatory Compliance Information	82
RED directive (EU)	82
FCC Compliance (US, Canada)	83
WPC Compliance (India)	83
ARIB Compliance	83
Regulatory Compliance Disclaimer	83
Typical Application Circuit	84
Power Supply	86
Appendix: ASCII Table	87
Document Revision History	88
Product Status and Definitions	89
Disclaimer	90
Trademarks	90
Life Support Policy	90
Contact Information	90

Tinymesh™ Application and Protocol Stack

The Tinymesh™ Multi-hop Wireless Mesh Network Protocol Stack is a unique set of multi-hop wireless mesh network protocols that enable devices to send messages or transfer data to and from each other. The embedded Application Layer contains an advanced set of configurable I/O handling mechanisms that enable Tinymesh™ devices to be implemented in most application circuits without need for an external MCU.

The Tinymesh™ Stack requires no external processor for establishing and maintaining the optimum network routing path at all times.

Internet applications may connect to Tinymesh™ Wireless Mesh Network through the equally uncomplicated Tinymesh™ Cloud Services.

Tinymesh™ Multi-hop Wireless Mesh Networks may consist of large numbers of Tinymesh™ enabled devices or nodes where a node is one out of three types as described below. The wireless traffic between the Tinymesh™ enabled devices follows a tree-type topology, where data transfer is up or down in the tree structure.

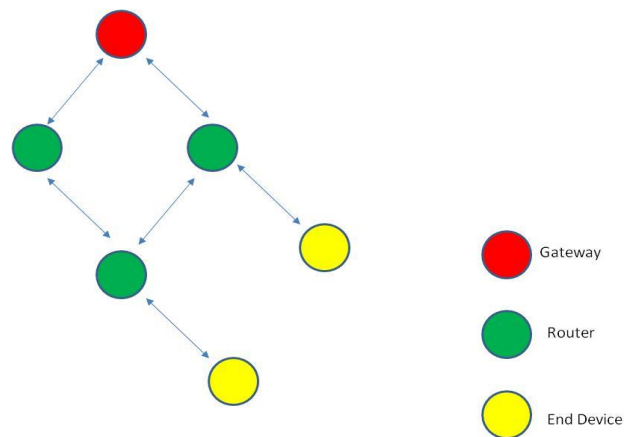

A Tinymesh™ Multi-hop Wireless Mesh Network in its simplest form consists of a single Gateway and a Router. End Devices will not perform packet routing and must connect to a Router or directly to a Gateway. A network may be comprised of thousands of Tinymesh™ enabled devices. There may be several Gateway devices within a network, for redundancy and automatic workload sharing.

The network addressing structure uses four-byte addressing, for a total of 4.3 billion possible unique devices per network. The network tree structure may have a total depth 255 hops.

Tinymesh™ Devices

Any Tinymesh™ enabled device may be configured to function as Gateway, a Router or as an End Device. Single byte configuration commands will set all relevant configuration parameters when changing operating mode.

Gateway Device

A Tinymesh™ network must have at least one Gateway Device. The Gateway Device initiates the network formation and is required to keep the network alive. Gateway Devices provide the connection between the Tinymesh™ Routers and End Devices, and an external host processor, or to a local- or wide area network, such as the Internet.

The Tinymesh™ stack supports implementations with multiple Gateways, where additional Gateway devices provide redundancy and data traffic load sharing.

Gateway devices support full Input / Output control capabilities, similar to Routers and End Devices.

Router Device

Router Devices are full-functioning devices with serial data UART and Input / Output capabilities. Router Devices provide the communication path between individual Router- or End-devices, and the network Gateway.

Router devices must always be powered, to support routing of packets received from other devices.

End Device

A Tinymesh™ END DEVICE will normally be in low power sleep mode for battery operation. End Devices have full input- and output control capabilities but will not accept messages for re-distribution from other devices.

An End Device will wake up to full power mode by external stimuli, such as a digital input level shift, serial data input, pulse counter activity or by internal clock. Wakeup conditions are selectable through configuration settings. After waking up, the End Device will generate an Event Message or a Serial in Message, depending on the wake-up condition. After delivering the message, the End Device will either return directly to sleep condition, or stay awake for a settable time period, to wait for response commands from a server or application outside the Tinymesh™ network.

Data Integrity

The Tinymesh™ stack uses several mechanisms to ensure safe and reliable data delivery with minimal latency.

- Listen Before Talk in accordance with the harmonized EN 300 220-2 standard, to reduce likelihood of RF traffic collision.
- Link level acknowledge on all packet deliveries for positive confirmation of data reception.
- Packet retransmission on missing acknowledge
- Format, data validity and CRC control on check on packet reception
- AES 128 encryption
- Packet duplicate check
- Housekeeping mechanisms to eliminate stray packets that are either too old or have hopped to many times
- Unique numbering of packets to allow duplicate and sequence control by external applications
- Application level command acknowledge to verify and validate command reception.
- Unique timing mechanisms to handle network congestion

Network Formation

A Tinymesh™ Multi-hop Wireless Mesh Network is self-forming, created by Gateway units starting to invite Routers and End Devices within RF range to join in the network. A Router joins the network after verifying the invitation, and immediately starts inviting new nodes to join. Within seconds of powering up the Gateway, a large network may be created automatically.

Gateway and connected Router devices send periodic beacon packets to indicate presence and availability for connection. Tinymesh™ beacon packets, referenced as HIAM packets, contain information of device address (UID), System Identity (SID), Radio Frequency Channel and device Network Level (Hop Level).

Routers and End Devices receive and evaluate connection alternatives by comparing hop level- and received signal strength of HIAM packets on selectable time intervals (Connect Check Time)

Self-healing

Devices in Tinymesh™ networks continuously evaluate alternate connections by comparing the hop level and signal strength of received HIAM packets. In cases where the primary

communication link becomes unresponsive, the device will automatically change to the alternate routing if such routing is available. If the alternate routing is also unresponsive, the device will enter a state where it searches for new routing possibilities. Data received by the device, and event data generated by the device will be stored in the internal device buffers until a valid connection has been established.

Self-optimizing

The communication path offering the least number of hops and the highest link quality is always selected as the primary connection for data delivery. A network optimization process runs continuously as a background task in all Tinymesh™ devices. In changing environments with changing link quality, Tinymesh™ networks dynamically adapt to find optimum routing.

Network Addressing

Tinymesh™ networks utilize a flexible addressing scheme with 4 bytes System address (SID) and 4 bytes for unique device addressing (UID).

The four-byte System ID identifies a local network in the same way as a PAN address. All devices in a local mesh must share the same four-byte SID.

Every Gateway, Router, and End Device belonging to a local mesh network must have unique UIDs. Duplicate UIDs will cause network instability, lost packets and connection issues.

A separate 4-byte Network Address is applied to uniquely distinguish local mesh networks sharing a common platform in a cloud or server controlled environment where local mesh networks may be deployed with similar SID.

The Tinymesh™ Stack supports unique, group and broadcast addressing of individual devices. Routers and End Devices may be assigned to addressing groups, by entering up to eight different single-byte group identifier addresses.

Multiple Gateway Support

Tinymesh™ networks support multiple Gateway devices operating within the same local mesh. In mesh networks with a single Gateway, the Gateway becomes a critical point for system reliability. In a Tinymesh™ network, additional Gateways may be added at any point in time to provide redundancy on the Gateway level. Adding Gateway devices to a local mesh also improves data throughput and network capacity, as the additional Gateway devices will automatically load share the upstream data traffic from for instance a large data collection or sensor network.

Systems with multiple gateways must be controlled by a common server or cloud platform, such as Tinymesh™ Cloud Services. Data originating from Router- or End Devices will automatically be routed through the mesh to the Gateway device that provides the least number of hops and the best signal strength. If two or more Gateway devices offer the same number of hops and equally good signal strength, for instance if the two Gateway devices are located near to each other, the packet will be delivered to the Gateway device that is currently available. The server platform will use the device UID to identify the packet origin, and the packet number contained in the packet header to verify uniqueness.

Commands (downstream data traffic) in multiple Gateway systems should as a rule be entered to all Gateway devices, to ensure reliable delivery. Systems where the Gateway devices are located close by each other, offer an exception to this rule. This will be systems where two or more Gateway devices provide redundancy and added throughput, and where the distance between the individual Gateway devices is less than the distance to the closest Router device. A single Gateway may be selected to dispatch commands in such configurations.

Ad Hoc Networks and Hand Held Gateway Devices

Local mesh systems that are created 'ad hoc' by turning on a portable Gateway device such as a portable CMRI used for data collection in automated metering systems will be formed as a web with the portable Gateway in the centre of the mesh network. Because there is no fixed rule to where a Gateway device is located, or when the mesh is created, there needs to be mechanisms in place to ensure there is only one Gateway device downloading from the mesh at a given time.

A configurable parameter in a Tinymesh™ Gateway device provides a mechanism for the Gateway to detect if a network is already present when the portable Gateway is powered up. Depending on the device configuration, the Gateway device will either refuse connection, provide an alert, or ignore the presence of the other Gateway that is controlling the mesh.

If a portable Gateway device is configured to ignore the presence of an existing mesh, a portable device may be used to temporarily connect to a device that is already connected to a stationary Gateway device. This function could be used in automatic metering systems with permanently installed data collection units (DCU), for individual interrogation or downloading of data directly to a portable device.

The portable device must share the same System ID as the permanent Gateway and must have unique UID. When turning on the portable device, the portable Gateway will connect to the closest Router devices and act as a secondary gateway in the system.

The portable device may interrogate the connected mesh to detect which Router devices have made connection.

After switching off the portable device, the mesh will automatically reconfigure with the permanent DCU as the preferred Gateway.

Alerts and Device Triggered Events

The application layer in the Tinymesh™ stack supports automatic alerts and triggered events from multiple, configurable sources, eliminating the need for traditional status polling as known from wired multi-drop systems.

- Timer triggered status reporting, with time intervals from seconds to days
- Digital input status change, with configurable de-bounce and edge detection
- Analogue level change, with configurable hysteresis, trigger conditions and sample interval
- Power On detection
- Serial data input
- Radio Frequency Jamming detection

Over the Air Configuration

Gateway, Router, and End devices may be reconfigured at any time, even after system deployment. The flexible format configuration command allows setting of any addressable location in the device configuration memory.

Remote reconfiguration capability is a valuable feature for system maintenance and service. Any configurable function, from changing the de-bounce time for digital input detection, to altering the radio frequency channel may be changed over the air.

A special two-step mechanism protects the most sensitive configuration parameters that may cause a device to lose network connection.

Getting Started

A simple Tinymesh™ network may be formed by configuring at least one module as a Gateway (SET GATEWAY MODE command).

Make sure **the Gateway and all Routers have different Unique ID, but same System ID**. This is mandatory for successful self-forming of the network.
Modules are delivered with default setting 'Router', and with non- identical Unique IDs.

How do I Form a Network?

Power up the nodes in any random sequence.

The Gateway Device starts inviting neighbouring nodes to become members of the network. The Gateway Device will flash the RSSI/ TX LED (Red LED on Demo Board) every time a network invite beacon (HIAM) is transmitted.

The RSSI/ TX LED on nodes configured as Router devices (default configuration) will start flashing in a slow pattern, indicating the node is alive and listening, but not connected to the network.

Router devices within acceptable radio range of the Gateway, will detect the invite beacons from the Gateway. If the received signal strength (RSSI) is within predetermined limits of acceptable signal strength, the Router Device will attempt connecting to the Gateway by sending an invite response. If the Gateway properly accepts the invite response, the Router has successfully joined the network, and will signal its new status by changing the LED flash pattern. The red RSSI Indicator LED now reflects the RSSI level of the established connection, and the yellow CONNECTION/ RX LED indicator starts flashing to indicate successful connection.

All Routers that successfully connect to the network will immediately start inviting new Routers to join the network, forming the next level of connected nodes. New Routers will again start inviting the next level of Routers, automatically propagating the network to encompass all Routers with identical System ID that are within radio range of at least one other Router or Gateway in the same network.

No external processing effort in the terms of a network organizer, controller PC or micro controller is required, as each node actively and autonomously participates in the forming of the RF network.

How do I Transmit Data?

This chapter refers to the the default operational mode named “transparent” for transparent, bidirectional data transfer.

Send your data to the RXD pin on the module. Use the UART format with default settings (19200, 8, 1, N, no flow control). Up to 120 payload bytes are buffered in the module. The module will transmit the data when

- the maximum packet length is reached (120 bytes)
- the modem time-out limit is reached (default 20ms)

Modules will by default use the UART CTS signal to indicate when data may be entered.

Routers will hold CTS high when the UART receive buffer is full. After successful connection to a network and delivery of the current contents of the UART buffer, CTS will go low, indicating the node is ready to receive data. CTS will remain low until the data buffer is full, or a byte-to-byte time out has occurred. CTS will then go high, indicating no more data may be entered. As soon as the data packet has been successfully transmitted and the data buffer is emptied, CTS will return low, to indicate new data may be entered.

Data may be entered in binary format, any byte value with proper start- and stop bit is accepted. The time-out limit is configurable in-circuit by changing the SERIAL PORT TIME OUT parameter in Configuration memory. Default setting is 20ms.

How do I Receive Data?

Any data entered at the Gateway (while CTS is low), will be delivered to all Routers that are connected to the network. Received RF data with correct check sum will be presented on the TXD pin of all Router(s).

Data entered at any Router Device (while CTS is low), will be delivered to the Gateway and presented on the Gateway TXD pin.

What about the Antenna?

In most cases, a simple quarter wavelength wire or a PCB track will do. Connect a piece of wire to the RF pin with length corresponding to the quarter of a wavelength. When space is limited, contact Radiocrafts for recommendations for the best antenna solution for your application.

How do I change the RF Channel or any other Parameter?

Configurable parameters such as RF Channel, RF Power or RF Data Rate, are stored in non-volatile memory in the module. There are principally two different ways for changing these parameters. The module must either be entered into CONFIGURATION MODE, for direct input of new parameters on the serial port, or new parameter values may be dispatched to a module in a live mesh network by issuing the SET CONFIGURATION command. Please see MODULE CONFIGURATION for details.

Module Pin Assignment

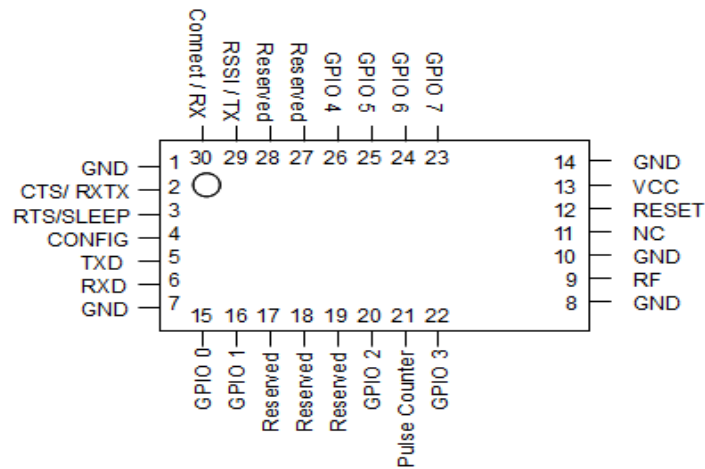



Pin Description, RC11xx(HP)/ RC25xx(HP) Devices

Pin no	Pin name	Pin type	Description	Equivalent circuit
1	GND		System ground	
2	CTS / RXTX	Output	UART CTS or RXTX	
3	RTS / SLEEP	Input	UART RTS or Module Sleep ² . Active low	
4	CONFIG	Input	Configuration Enable. Active low. Should normally be set high ³ .	
5	TXD	Output	UART TX Data	
6	RXD	Input	UART RX Data. <i>Use external max 8k2 pull-up resistor if connected to an open collector output from a host MCU or other high impedance circuitry like level shifters.⁴ Never leave RXD-pin floating.</i>	
7	GND		System ground	
8	GND		System ground	
9	RF		RF I/O connection to antenna	
10	GND		System ground	
11	NC		Not connected	

² The internal pull-up is disabled when configured for SLEEP function.

³ The internal pull-up is disabled when the SET SLEEP MODE (Z-COMMAND) has been used to enter sleep mode

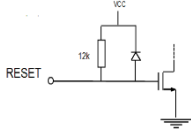
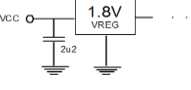
⁴ For UART communication, the TXD and RXD are used for serial data, and CTS for flow control. RXD must be high when not sending data to the module.

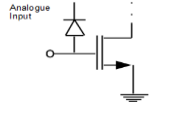
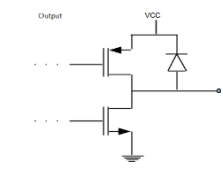
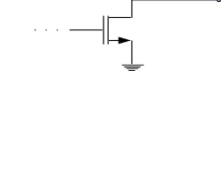
12	RESET	Input	Main reset (active low). Should normally be left open. Internal 12 k pull-up resistor.	
13	VCC		Supply voltage input. Internally regulated.	
14	GND		System ground	
15,16	GPIO 0-GPIO 1	Digital In / out Analogue In	Individually configurable as digital input / output or analogue Input (Internal pull-up disabled)	 Digital Input/ output, Ref pins 2-6
20	GPIO 2-GPIO 6	Digital In / out	Individually configurable as digital input / output	Ref pins 2-6
21	Pulse Counter	Input	Pulse Counter	Ref pins 2-6
22,26,25,24	GPIO 3-GPIO 6	Digital In / out	Individually configurable as digital input / output	Ref pins 2-6
23	GPIO 7	Digital In / out PWM out	Configurable as digital input / output or PWM output	Ref pins 2-6
17-19, 21, 27, 28	RESERVED		Test pins or pins reserved for future use. <i>Do not connect!</i>	
29	RSSI/ TX LED	Output	Direct LED drive output. Flash pattern given for current sourcing: Flash frequency indicates network connection RSSI level for Routers and End Devices. Flash indicates RF TX activity for Gateway Devices.	
30	Connection/ RX LED	Output	Direct LED drive output. Flash pattern given for current sourcing: Flash frequency indicates network connection redundancy for Routers and End Devices. Flash indicates RF RX (received packets) for Gateway Devices	

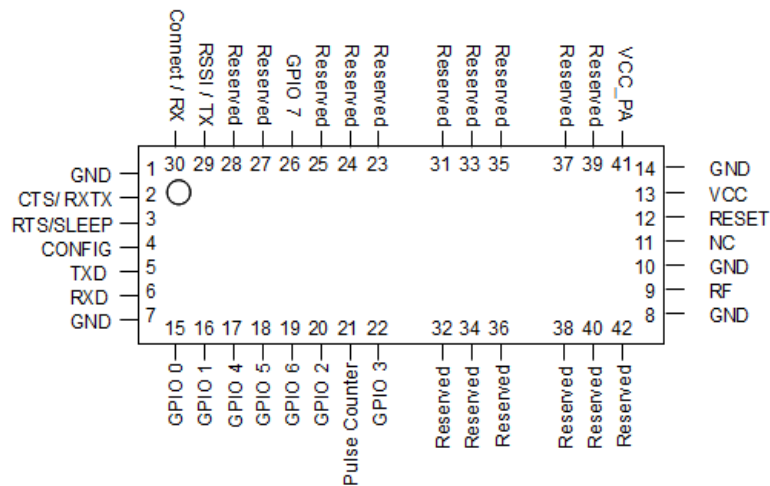



Pin Description, RC17xx Devices

Pin no	Pin name	Pin type	Description	Equivalent circuit
1	GND		System ground	
2	CTS / RXTX	Output	UART CTS or RTX	
3	RTS / SLEEP	Input	UART RTS or Module Sleep ⁵ Active low	
4	CONFIG	Input	Configuration Enable. Active low. Should normally be set high ⁶ .	
5	TXD	Output	UART TX Data	<p>Use external max 8k2 pull-up resistor if connected to an open collector output from a host MCU or other high impedance circuitry like level shifters.⁷ Never leave RXD-pin floating.</p>
6	RXD	Input	UART RX Data.	
7	GND		System ground	
8	GND		System ground	
9	RF		RF I/O connection to antenna	
10	GND		System ground	
11	NC		Not connected	
12	RESET	Input	Main reset (active low). Should normally be left open. Internal 12 k pull-up resistor.	

⁵ The internal pull-up is disabled when configured for SLEEP function.

⁶ The internal pull-up is disabled when the SET SLEEP MODE (Z-COMMAND) command has been used to enter sleep mode

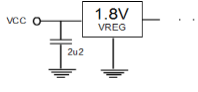
⁷ For UART communication, the TXD and RXD are used for serial data, and CTS for flow control. RXD must be high when not sending data to the module.

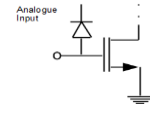
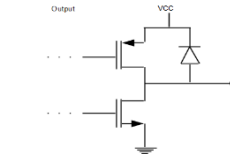
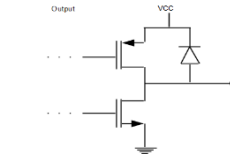
13	VCC		Supply voltage input. Internally regulated.	
14	GND		System ground	
15,16	GPIO 0-GPIO 1	Digital In / out Analogue In	Individually configurable as digital input / output or analogue Input (Internal pull-up disabled)	 Digital Input/ output, Ref pins 2-6
17, 18,19, 20,22, 26	GPIO 2-GPIO 7,	Digital In / out	Individually configurable as digital input / output	Ref pins 2-6
21	Pulse Counter	Digital Input	Pulse Counter	Ref pins 2-6
29	RSSI/ TX LED	Output	Direct LED drive output. Flash pattern given for current sourcing: Flash frequency indicates network connection RSSI level for Routers and End Devices Flash indicates RF TX activity for Gateway Devices	
30	Connection/ RX LED	Output	Direct LED drive output (source). Flash pattern given for current sourcing: Flash frequency indicates network connection redundancy for Routers and End Devices. Flash indicates RF RX (received packets) for Gateway Devices	
41	VCC_PA	Supply voltage input for Power Amplifier stage	Connect to 5V or VCC for RC17x0HP and leave open for RC17xx. When VCC_PA is connected to VCC (3.3V) for RC17x0HP, the max output power is limited to +24 dBm. For RC1701HP, the VCC_PA has the same voltage range as VCC, and supports +27 dBm at 3.3 V.	
23,24, 25,27, 28,31, 32,33, 34,35, 36,37, 38,39, 40,42	RESERVED		Test pins or pins reserved for future use. <i>Do not connect!</i>	

Circuit Description

The Tinymesh™ module contains a communications controller with embedded Tinymesh™ protocol stack firmware, a high-performance RF transceiver and an internal voltage regulator.

The communications controller handles the radio packet protocol, the UART interface and controls the RF transceiver. Data to be sent by the host is received at the RXD pin and buffered in the communications controller. The data packet is then assembled with preamble, start-of-frame delimiter (SOF), network routing information and CRC check sum before it is transmitted on RF.

The RF transceiver modulates the data to be transmitted on the RF frequency and demodulates data that are received. Received data are checked for correct address and CRC by the communication controller. If the address matches the module's own address, and no CRC errors were detected, the data packet is acknowledged before re-transmitted. The asynchronous UART interface consists of RXD, TXD, RTS and CTS. The CTS output will be TRUE LOW when the module is ready to receive data. CTS must be monitored on a **byte-by-byte basis** to avoid losing data when the default CTS handshake configuration is enabled.

When the CONFIG pin is pulled low, the communications controller interprets data received on the RXD pin as configuration commands. There are commands to change the radio channel, the output power, the RF Data Rate etc. Configuration parameters are stored in non-volatile memory. For a full overview of configuration commands, please see MODULE CONFIGURATION

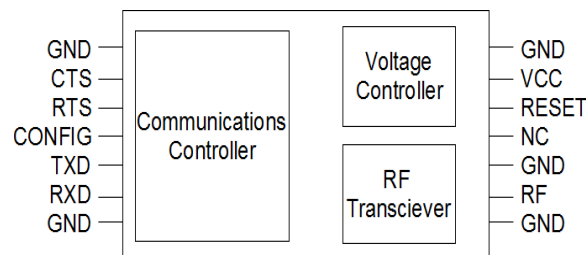

Selecting the Right Module for Your Application

Radiocrafts modules with embedded Tinymesh™ Protocol Stack are available for all the international license free frequency bands, in two different selections of output power, and as high performance, long range Ultra Narrow Band version. As new members are added to the Radiocrafts family of modules, the Tinymesh™ Stack will be introduced on the new platforms.

All Radiocrafts modules are fully tested and footprint-compatible, allowing equipment manufacturers to use the same electronics design for several markets and varying applications.

The inherent capability to select and configure communications parameters in the protocol stack provides an unsurpassed level of flexibility in adapting the design to the application requirements.

The right module for your application may be selected from a decision matrix weighting the importance of radio range coverage, RF compliance requirements, customer requirements, hardware cost and available power supply limitations.

Note: High and Low power modules should not be mixed in the same network, unless the output power settings for all modules are limited to the same dBm level.

Transmission from the high power module may be received by the low power module, while the high powered module will not be able to detect transmission from the low power device.

End Devices or Router Devices configured to transmit in FIXED DESTINATION AND "Walk By" Mode represent an exception to the rule, as these devices will transmit without expecting a response (ACK) and hence will not require a balanced connection link.

Indicative Module Selection Guide

Lower RF frequency	Higher RF frequency
Improved communication range	Shorter and less space demanding antenna
Theoretical Range is approximately inversely proportional to RF frequency. (Double frequency = half range)	2.4 GHz is license free band in many countries and regions.
Lower dependency on direct Line of Sight between devices	
Low Power (standard) Module	High Power (HP) Module
Low Transmit power, simplified power supply design.	Better range, theoretical range improvement approximately double range per+6 dB increase in output power.
Best price performance	
Long Range Ultra Narrow Band (RC17xx)	Wide Band (RC11xx/ RC25xx)
High performance, high selectivity radio Excellent long range and performance	Good performance, good range Best price

RCTools

RCTools is a powerful and easy to use PC suite that helps you during test, development and deployment of the RC11XX(HP) / 25XX(HP)-TM. The tools may be used for both configuration and communication testing. Visit www.radiocrafts.com for a free download and full documentation.

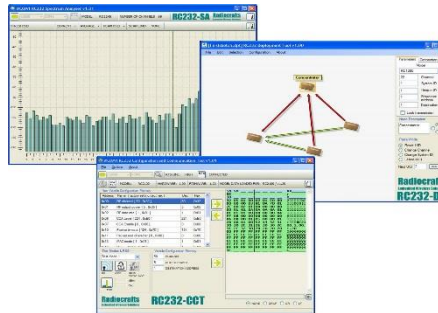

Transparent Mode Operation

The default, factory setting for Tinymesh™ Gateway modules, is transparent mode, well suited for applications requiring serial data transmission only. In transparent mode, UART data entered at the Gateway, will be received by all Routers in the network, and will be output by the Router module UARTs without any changes. The addressing must be handled by the host MCU application.

Data input to a Router or End Device UART will be transported 'transparently' to the network Gateway Device and delivered unchanged by the Gateway Device UART. Regardless of device type (Gateway or Router), the serial port UART is ready to receive data when the CTS output is low, or when the Xon character has been received from the UART. RF transmission will automatically be triggered on serial buffer full or character time-out on the serial port. The connected host MCU should always observe the selected handshake status (CTS or Xon/Xoff) before sending any data, to avoid losing data.

Transparent- Versus Packet- Mode Operation

When configured for PACKET MODE OPERATION, the Gateway Device may be used for controlling Inputs- and Outputs in individual Routers and End- Devices. Analogue and digital input monitoring, digital and PWM output control, and timed or event triggered messages are available through Packet Mode operation. Gateway Commands may be addressed to individual devices, to groups of devices, or may be broadcast to all devices within a network. Serial data entered and received at the Gateway will contain extra bytes for addressing, command and control.

Transparent- and Packet Mode Functions

Serial Data Streaming

When streaming serial data from a Router Device or from a Gateway Device in Transparent Mode, the data stream will automatically be divided into correctly sized Tinymesh™ RF packets before data is transmitted in the mesh network. The Serial Data Input Buffer has a capacity of 256 bytes, allowing for e.g. a complete MODBUS RTU packet to be received. The Tinymesh™ module will signal a full buffer condition by setting the CTS output high, or by issuing an Xoff character, as configured by the UART FLOW CONTROL parameter. The SERIAL BUFFER FULL MARGIN parameter provides for an adjustable margin from the buffer full condition is signalled, until the Serial Data Input Buffer overflows. The default setting of the SERIAL BUFFER FULL MARGIN parameter is 18 bytes, allowing the host MCU a margin of some additional bytes that may be transmitted before the Serial Data Input Buffer in the module runs full. The default value of 18 bytes has been chosen to optimize packet sizes when streaming data. Most host systems and terminal emulators will be able to respond to the 'CTS off' status within the time needed to transmit two bytes. At this point, there will be 240 bytes received in the Serial Data Input Buffer, which is the maximum size of two full Tinymesh™ RF packets.

The host MCU should stop transmitting data as soon as possible after detecting CTS off, or after receiving the Xoff character. After a time period of a few milliseconds, as determined by the SERIAL PORT TIME OUT parameter, the Tinymesh™ module will start forming new RF packets from the received data, and initiate RF transmission.

If the serial data stream does not stop after the module has signalled the 'buffer full' condition, The Tinymesh™ protocol stack will prepare the data for RF transmission immediately after a data buffer completely full condition is present (256 bytes).

Note: Subsequent data delivered to the UART will then be lost if the data stream continues before the module Serial Data Input Buffer is again available.

After successful transmission of the received data, the module will signal to the external MCU that the Serial Data Input Buffer is again available, by setting the hardware handshake CTS signal low, or by transmitting an Xon character.

Serial Port Handshake

The Gateway and Router serial ports (UARTs) offer several optional handshake settings to support reliable connections to an external host controller. The different settings are available by changing the UART FLOW CONTROL parameter in CONFIGURATION MEMORY. The UART FLOW CONTROL parameter is a bitmap of control mechanisms that may be individually enabled by setting the corresponding bit. To combine settings, add the values in the 'Bit Value' column and enter the sum value into the UART FLOW CONTROL parameter in CONFIGURATION MEMORY.

Bit No	Bit Value	Default	Name	Applies to	Function
0	1	1	CTS	Router and Gateway	The CTS control signal will be low when the module is ready to receive data. The external host should monitor the CTS line before transmitting any data, as the module will discard data received while CTS is high. The SERIAL BUFFER FULL MARGIN parameter in Configuration Memory may be used to set CTS off a number of bytes before the buffer is completely full, thereby allowing the host system time to respond to the CTS off situation. This function is important when for instance using hardware handshake on a system with USB serial ports.
1	2	0	RTS	Gateway	The RTS control signal may be used by an external host to signal that the host is ready to receive data. When enabled, the module will observe the RTS line before transmitting any byte. No data will be transmitted while RTS is high. <i>Note: If RTS is enabled, and the host does not set RTS TRUE</i>

Bit No	Bit Value	De-fault	Name	Applies to	Function
					<i>(Low), a connected Gateway Device will not be able to deliver data, and consequently the Gateway will not receive data from the mesh network. The mesh network will disconnect.</i>
2	4	0	RXTX	Router and Gateway	The RXTX mode is provided for direction control of RS485 drivers. When RXTX is enabled, the module UART will set CTS HIGH during data transmission. CTS will be driven high immediately before the first start-bit is transmitted and will return low immediately following the last stop bit from the UART.
3	8	0	Xon/Xoff	Router and Gateway	When the Xon/ Xoff function is enabled, the module UART will transmit an Xoff character (Value 0x13, ASCII DC3) a settable number of bytes (SERIAL BUFFER FULL MARGIN) before the buffer runs full. The external host MCU should then halt further data transfer until an Xon (0x11, ASCII DC1) character has been received. An Xon character will be transmitted continuously at 1 second intervals while the module is ready to receive data. The Gateway Device will only support Xon/ Xoff when in transparent mode. Please also note that binary data transfer will not work with Xon/ Xoff, as the binary data may contain the Xon / Xoff characters.
4	16	0	ACK/NAK	Gateway	When enabled, the Gateway Device will answer any received data on the serial port with a COMMAND RECEIVED AND EXECUTED or a COMMAND REJECTED, NOT EXECUTED message. In this mode, the Gateway will do a format- and validity control of received commands before transmitting in the RF mesh network. The MESSAGE DATA MSB will contain the user selected Command Number. If the packet is not accepted by the Gateway Device, the MESSAGE DATA LSB in the returned COMMAND REJECTED, NOT EXECUTED message will indicate why the packet was not accepted.
5	32	0	Wait For ACK	Gateway	When enabled, the Gateway Device will expect an ACK character (0x06, ASCII ACK) response to any packet delivered to the host. If the ACK is not received within a 1second time frame, the packet will be repeated until a valid response has been received. The Gateway device will dispatch a NAK character (0x07, ASCII NAK) on receiving incomplete or illegal commands when Wait For Ack is active ¹³
6	64	0	Append CRC ⁸	Gateway	When enabled, the Gateway Device will append a two-byte CRC16 checksum to the packet. The packet start byte will be incremented by 2 to indicate the longer packet length. Note that the CRC append feature only applies to packets FROM the Gateway device. CRC is calculated per CRC-16/BUYPASS (CRC16/VERIFONE, CRC-16/UMTS) Using 0x800 polynom and 0x0000 seed.
7	128				Reserved

AES Encryption

Changing the SECURITY LEVEL parameter in CONFIGURATION MEMORY will enable automatic AES data encryption. When AES encryption is enabled, the payload portion of all RF data packets are encrypted using the 128 bit AES encryption algorithm.

The Gateway and Router Device must share a common AES key, settable by the SETTING AND CHANGING THE AES KEY (K7- COMMAND).

The encryption key is stored in a hidden and secure memory location.

The AES key is retained even after an @TM factory-reset command.

Encrypted and unencrypted Router Devices may co-exist and will connect to a common network. A Gateway Device will be able to receive data from encrypted, as well as

⁸ Available from firmware release 1.51

unencrypted, Router Devices, but an unencrypted Router Device will not be able to receive and interpret encrypted commands.

Co-Existence with AES Encrypted and Un-Encrypted Devices

Nodes with encryption enabled, may co-exist with unencrypted nodes in a common system. Encrypted data packets are slightly larger than unencrypted packets. SECURITY LEVEL 2 (Compatible mode) is provided for backwards compatibility to field deployed systems where encryption has not been enabled.

In systems with a mixture of encrypted and unencrypted nodes, the following rules will apply:

- Encrypted packets will be transported by unencrypted nodes to their final destination.
- Un-encrypted packets will be transported by encrypted nodes to their final destination.
- Encrypted nodes will not accept receipt of unencrypted packets (commands or serial out packets)
- Un-encrypted nodes will not accept receipt of encrypted packets (commands or serial out packets)
- An encrypted Gateway will accept and decrypt messages from encrypted nodes, as well as accept data packets from unencrypted nodes.
- An un-encrypted Gateway will only accept messages from un-encrypted nodes.

Sleep Mode

A Tinymesh™ Device may be set to sleep mode to reduce power consumption.

Note: When asleep, a Router Device will not provide network routing for other devices, and a Sleeping Gateway device will not issue HIAM beacons.

Tinymesh™ networks will disconnect if no Gateway Device is active.

These conditions must be considered when designing a network with sleeping devices.

Sleep mode may be entered either by issuing the SET SLEEP MODE command while the module is in CONFIGURATION MODE, or by pulling the RTS / SLEEP pin low, after activating the SLEEP function through proper configuration setting (SLEEP OR RTS).

The sleeping Device will wake up, go through a full Power-On Reset cycle and resume operation when:

- The Configuration pin is driven high, if SET SLEEP MODE-command was used for entering sleep mode.
- The UART RXD pin is driven low from start bit detection, if the ALTERNATE SET SLEEP MODEAlternate Set Sleep ModeAlternate Set Sleep ModeAlternate Set Sleep ModeAlternate Set Sleep Mode command was used for entering sleep mode.
- When driving the RTS / SLEEP pin high, if the RTS / SLEEP pin was used to enter sleep mode.

To enter/ exit sleep mode using the RTS / SLEEP pin input:

1. Activate the RTS / SLEEP pin by setting SLEEP OR RTS configuration= 1.
2. Pull the RTS/SLEEP input low to enter sleep mode
3. Drive the RTS/SLEEP input high to exit sleep mode.

Note: The internal RTS/ SLEEP and CONFIG input pull-up resistors are disabled during sleep mode to reduce excessive power leakage. The CONFIG and SLEEP inputs must therefore be actively driven to the logic high state to exit sleep mode.

On exiting sleep mode, the Router Device will assume normal operation and connection to the mesh:

- CTS will be high while the module is going through the Reset cycle, and then go low when the module has made a valid network connection.

- If XON/XOFF protocol is enabled, (UART FLOW CONTROL), a single Xoff character will be issued after completed reset cycle. The first Xon character will be issued after successful connection to the mesh.
- The CONNECTION INDICATOR LED will start flashing.
- A DEVICE RESET message will be issued.
- A STATUS MESSAGE (IMA) will be issued if IMA ON CONNECT is enabled.

RF Jamming Detection and Alarm

The RF Jamming Detection feature is a unique Tinymesh™ function, providing timed logging and alarming of RF conditions that may inhibit radio communication. Radio Frequency interference that may influence RF connectivity may be present in form of intended (jamming) disturbance, or unintended noise from electrical equipment or RF transmitters.

The following Configurable parameters control the RF Jamming alarm feature:

- The RF JAMMING DETECT parameter sets the number of minutes of RF jamming that constitutes an alarm condition. The default value is 0 = off.
- The RF JAMMING ALARM PORT parameter selects the GPIO number (0-7) for local alarm output.
- The GPIO parameter sets the selected GPIO function as active low or active high output.

RF Jamming Detection in Packet Mode Systems

When RF Jamming Detection has been enabled by setting the RF JAMMING DETECT parameter, the Tinymesh™ module will create an RF JAMMING DETECTED message that will be transmitted through the mesh as soon as RF communication is re-established. The RF JAMMING DETECTED message MESSAGE DATA MSB will indicate the duration of the jamming situation in minutes, and the MESSAGE DATA LSB will indicate the time since the jamming condition ended in hours.

Clustered Node Detection and Network Congestion Avoidance (CND/NCA™)

The Clustered Node Detection feature is a unique Tinymesh™ function, provided to prevent RF network congestion in situations where multiple Tinymesh™ devices are located densely together. In, for instance, energy metering installations, large groups of meters may often be located side-by-side, forming clusters of devices ranging from a handful of units, to tens or hundreds of meters in the same location.

In such clustered situations, there is a risk of excessive amounts of radio traffic, causing network congestion and bad connectivity, as the RF bandwidth will be filled with radio packets intended for network maintenance, and there will be very little bandwidth available for data packets containing payload data.

The Clustered Node Detection feature is controllable through the following, configurable parameters:

CLUSTERED NODE RSSI. The default RSSI setting is 60 (-30 dBm). Lower settings will effectively disable this function, as the value will be lower than the RX saturation level for the radio. By increasing the value, the cluster detection function may be adapted to situations with modules using lower TX output power.

CLUSTERED NODE DEVICE LIMIT. The default setting is 10, forcing the clustered node detection function to start reducing unnecessary RF traffic when more than ten devices are located closely together.

Optimizing Polled Systems

Wireless Tinymesh™ networks are well suited for replacement of wired multi-drop systems, offering significantly lower installation and infrastructure cost. Transparent as well as Packet mode configurations of Tinymesh™ may satisfy the requirement for an RS485 or similar multi-drop replacement.

Multi-drop systems often use a polled communication protocol, with a master device sending individually addressed, or broadcast 'poll' commands, asking for response from slave devices.

A wireless mesh will generally provide less communication bandwidth as compared to a wired system, and unnecessary communication overhead should be avoided when possible, to increase payload throughput. The Tinymesh™ protocol stack provides a number of mechanisms that serve to improve data throughput in master-slave systems.

In systems configured for TRANSPARENT MODE OPERATION, it is advisable that the master (Gateway) performs broadcast polling rather than sending individual device poll commands.

Note: Successful implementation of broadcast polling requires that the networked devices will respond with data packets containing the device address as part of the data payload.

When receiving a command broadcast, the networked devices will attempt communicating the command response more or less simultaneously after executing the received command. The Tinymesh™ Router Device that first detects a clear RF channel when performing the Listen Before Talk procedure, will immediately start transmission. Other devices will detect that the radio channel is busy and will retry communication after a random time period. This automatic retry mechanism will ensure that responses from all devices are communicated to the master (Gateway) Device error free and within an optimum time period.

Tinymesh™ Packet mode configuration provides additional means for creating efficient replacements for wired, polled systems. In Tinymesh™ wireless networks configured for PACKET MODE OPERATION, the ORIGIN ID of the response packet may be used to identify the individual device, eliminating the requirement for having device address as part of the data payload. Individual Tinymesh™ devices may also be set to generate automatic, time generated status reports, and devices may be configured to automatically generate messages on digital or analogue input status changes, eliminating the need for the master controller poll function. For further information, please reference the later chapter on AUTOMATIC STATUS REPORTING.

LED Indicators

Module pins RSSI/ TX LED and CONNECTION/ RX LED are designed to directly drive LEDs. The Red LED (D1) of the Radiocrafts Demo Board is connected to module pin RSSI/ TX LED, and the Yellow LED (D2) is connected to module pin CONNECTION/ RX LED.

We recommend that these LED outputs are also implemented in target hardware. The LED signals will be useful for system deployment and configuration.

Flash patterns as documented in the data sheet assume the outputs to be sourcing power to the LEDs. This is the recommended configuration, that will also work for low power, battery operated devices while in sleep mode.

If using the outputs as power sinks, the LED flash patterns will be inverted, and connected LEDs will leak power while the module is in sleep mode.

LED Indicator Time-Out

In many applications, the LED indicators will be useful during installation or for field service purposes. After installation, the indicators may in some applications no longer be desirable. For battery operated End-Devices the indicators will represent an undesired power consumption.

The configurable INDICATORS ON⁹ parameter determines the time the indicator outputs are active after a power-up reset. By default, this parameter is set to 255 = permanently ON for Gateway and Router Devices. For End Devices, the parameter will automatically be set to default value 1 for a one-minute time-out, when using the 'N' - SET END DEVICE MODE configuration command to change between operational modes.

Setting the INDICATORS ON to 0 will permanently disable the indicator function.

Pulse Counter Feedback Indicator

Any GPIO may be configured as a feedback output for the pulse counter mode. Please see

PULSE Count Verification for details on the Pulse Counter Feedback function.

The duration of the pulse counter feedback is also controlled by the INDICATORS ONINDICATORS ON parameter, which will optionally disable this output after a pre-set time-out.

RSSI Indicator LED

When configured as a Router or End Device, an LED connected to module pin RSSI/ TX LED (Radiocrafts Demo Board Red LED, D1), will function as an RSSI indicator for TinyMesh™ Router or End Device modules. The LED will flash with one of the following frequencies/ intervals, based on RSSI level for the established connection:

1. Very fast flash (Five flashes per second):
RSSI is better than configured EXCELLENT RSSI LEVEL
2. Fast flash, (Two flashes per second):
RSSI is good, at least CONNECTION CHANGE MARGIN better than RSSI ACCEPTANCE LEVEL
3. Moderate flash, on for 1 second, off for 1 second:
RSSI is acceptable for reliable communication
4. Very slow (2 seconds ON, 2 seconds off):
RSSI is below the RSSI ACCEPTANCE LEVEL that will allow new connection. No new connections will be established at this low RSSI, but existing connection may still exist if the Connection LED is still flashing

⁹ Available from TinyMesh™ firmware release 1.40

Connection Indicator LED

When configured as a Router or End Device an LED connected to module pin CONNECTION/ RX LED (Radiocrafts Demo Board Yellow LED, D2), will function as a connection indicator. The LED will flash with one of the following patterns:

1. Steady ON:
The device has established direct connection to a Gateway Device, and at least one more Gateway Device is available for alternate routing.
2. Rapid flash, 5 times per second:
The device has established direct connection to a single Gateway Device.
3. Fast flash, 2 times per second:
The device has established connection to a Router Device, and at least one more Router Device is available on the same jump level, as an alternate route (redundant connection)
4. Moderate flash, ON for one second and OFF for one second:
The device has established connection to a single Router Device, and no alternatives exist on the same jump level.
5. No light: The device is disconnected
6. The Connection LED is flashing in sync with the RSSI Indicator LED immediately from module Reset / Power up: The Device is configured with a FIXED DESTINATION ID

Both LED outputs from the module may also be monitored by an external MCU for other visualization of RSSI level and network connection quality.

The device connection status may be included in the data field of STATUS MESSAGE (IMA) messages¹¹.

Radio RX /TX Indicator LED

When configured as a Gateway Device, an LED connected to module pin RSSI/ TX LED (Radiocrafts Demo Board Red LED), will flash every time an RF packet is transmitted. An LED connected to module pin CONNECTION/ RX LED (Radiocrafts Demo Board Yellow LED), will flash every time an RF packet with valid formatting and valid CRC is received.

Configuration mode indicator

When TinyMesh™ modules enter into Configuration mode, the two LEDs will both be turned ON. On exit from Configuration Mode, the LEDs will resume original function as either RX/TX indicator for Gateway Devices, or Connection Quality indicators for Router Devices.

Packet Mode Operation

When configured for packet mode operation, serial data and command packets may be broadcast to all devices, addressed to a group of devices, or addressed to a specific Router or End Device. Packet mode allows for setting and reading of the GPIO pins on the module, as well as reading the two analogue inputs, and activating the PWM output control for dimmer or speed control applications. Digital and analogue inputs may be set to trigger messages on input condition changes.

Routers will acknowledge receipt and acceptance of commands and data. The Acknowledge packet will be available on the Gateway UART.

The Gateway Device will provide additional, bi directional ACK / NAK handshake for error free connection to an external host

Gateway in Packet Mode

All data entered on the Gateway UART in Packet mode must follow strict formatting rules. The following tables describe packet formatting for transmitted and received packets. Please note data must be entered in one, contiguous string of bytes.

Note: Any time gap of more than the configured SERIAL PORT TIME OUT value will cause the Gateway to treat the entered data as a complete packet. If a time-out should occur before the intended end of the packet, the Gateway will not recognize the packet format, and the packet will be discarded (lost).

Router in Packet Mode

Router Devices behave similarly in Transparent and Packet mode. All packets will always be routed to the Gateway Device. Packet formatting and addressing is handled automatically by the Router firmware, and binary serial data may be entered to the Router UART without packet formatting and address information. Serial data packets will be transmitted immediately when the UART buffer is full (256 bytes), or after a configurable SERIAL PORT TIME OUT time gap between characters.

Note: To switch between Transparent and Packet Mode operation, only the Gateway configuration needs to be changed.

Transmitting Command and Configuration Packets from Gateway

Gateway commands may be used to transmit serial data, to set or read GPIO pins, to enquire module operating status, or to alter settings in the Configuration Memory of Router Devices.

All GPIO pins are initially configured as digital inputs with no triggering enabled. The desired GPIO function must be configured by altering the CONFIGURATION MEMORY settings, to enable functions such as Analogue input, PWM control, Digital Output or Input Trigger functions.

Tinymesh™ modules may be configured through the UART in Configuration Mode (CONFIGURATION COMMANDS), or while operating in a live mesh network by issuing SET CONFIGURATION commands from the Gateway Device.

Note: To avoid losing connection with devices in a live mesh network, the RF CHANNEL, RF DATA RATE, UNIQUE_ID and SYSTEM_ID may only be changed through Gateway Commands before the SYSTEM_ID has been changed from the factory default setting.

The Command Packet formats for module control, inquiry and configuration, are shown in the COMMAND PACKET FORMAT table.

Group and Broadcast Addressing

Commands may be broadcast to all devices in a network by selecting '255 255 255 255' as the NODE ADDRESS .

Router and End Devices may also be assigned to addressing groups, by entering up to eight different single-byte group identifier addresses in the configurable module GROUP TABLE. The most significant byte of the UNIQUE_ID in the command NODE ADDRESS is interpreted as a group identifier by the receiving device. The addressing structure for group commands is '255 255 255 nnn', where the 'nnn' byte represents the group identifier.

Example: Commands addressed for '255 255 255 003' will be accepted by any router belonging to group #3, identified by one of the group bytes in the module GROUP TABLE set to '3'

Command Acknowledge

On receiving a command packet, the Router or End Device will perform a validity check of the received data before executing the command. If the COMMAND ACKNOWLEDGE function is enabled, the device will return an event packet indicating if the packet was accepted.

Note: Broadcast and Group commands will only generate response packets if the COMMAND NUMBER is set larger than 127¹⁰

- The selectable COMMAND NUMBER will be returned in the MESSAGE DATA MSB field of the response packet.
- A COMMAND RECEIVED AND EXECUTED Event Message will be returned if the received command passes the test criteria.
- If command data or arguments are out of range, a COMMAND REJECTED, NOT EXECUTED Event packet will be returned. The MESSAGE DATA LSB field of the returned packet will indicate the reason for rejecting the command.

Gateway Devices in Packet Mode will generate ACK or NAK response to Commands if the ACK/ NAK serial port handshake has been enabled. The response packet format is a short form of the regular COMMAND RECEIVED AND EXECUTED or COMMAND REJECTED, NOT EXECUTED event packets, truncated immediately following the MESSAGE DATA LSB FIELD.

Command Packet Format

Byte #	Field	Size	Description	
			Control and Status request	Change Configuration
1	Start character	1	10 (0x0A) Equals length of string	40 (0x28) Equals string length
2	Node Address	4	Configured value of destination node or use broadcast ID (255 255 255 255) if command for all units. Gateway devices will respond to commands where Node Address = Unique ID (UID), or where Unique ID = 0 0 0 0 ¹¹	
6	Command Number	1	User selectable. This number will be returned as part of the Acknowledge-packet from the Router on completed command execution	
7	Packet Type	1	3 (0x03) Fixed value	

¹⁰ Introduced with Tinymesh™ release 1.40

¹¹ Introduced with Tinymesh™ release 1.43

Byte #	Field	Size	Description	
			Control and Status request	Change Configuration
8	Command Argument	1	1 (0x01) Set Outputs 2 (0x02) Set PWM 5 (0x05) Set Gateway in Config Mode 8 (0x08) Toggle Outputs ¹² 16 (0x10) Get NID 17 (0x11) Get Status 18 (0x12) Get DID Status 19 (0x13) Get Configuration Memory 20 (0x14) Get Calibration Memory 21 (0x15) Force Router Reset 22 (0x16) Get Packet Path	3 (0x03) Set Configuration
9	Data 1	1	Set Outputs and Toggle Outputs: Bitmap for setting GPIO 0..7 Set PWM: 0-100 % duty cycle. For other Command arguments, this byte is don't care.	Data 1..33 (32 bytes) 1 st . Byte = address 2 nd . Byte= value 32 rd . Byte=last address 33 rd . Byte=last value
10	Data 2	1	Set Outputs: Bitmap for clearing GPIO 0..7 Toggle Outputs: Toggle time in ms For other command arguments, this byte is don't care.	Address=00 indicates last valid address.(see example)

Note: The sequence of the UIDs below are UID0-UID4

Command Example: Set Router Configuration, Router UID 1 2 3 4,
Configure GPIO 0 as Output, default High, (Config Address 16 = 0)
Configure GPIO 7 as pulse width modulated output, (Config Address 23= 3)
Configure GPIO 4 as Input, negative edge trigger (Config Address 28 = 2)

Decimal notation
40 1 2 3 4 6 3 3 16 0 23 3 28 2 0

Hex Notation
28 1 2 3 4 6 3 3 10 0 17 3 1C 2 0

Copy & Paste string for CCTool
'40 1 2 3 4 6 3 3 16 0 23 3 28 2 0'

For more examples and practical demo cases, continue to Demo Board Exercises

Transmit Serial Data Packet from Gateway

Enter Serial Data Packets to be transmitted to individual Router Devices, using the following packet format. Maximum packet size is 120 bytes. Payload data bytes may be any format (binary data). Please note the start byte is a calculated value

Byte #	Field	Size	Description
1	Start Byte	1	Calculated value, total number of bytes, including Start Byte
2	Node Address	4	Configured value of destination router or use broadcast ID (255 255 255 255) if Serial Data Packet for all units.
6	Command Number	1	User-selectable number, returned as part of the Acknowledge packet from the Router on completed command execution
7	Packet Type	1	17 (0x11) Fixed value
8	Serial Data	1..120	Binary data

Example 1, Send text string 'Hello' from Gateway to Router with UID 0 0 1 2, packet no 6

Decimal notation	Hex Notation
12 0 0 1 2 6 17 72 101 108 108 111	C 0 0 1 2 6 11 48 65 6c 6c 6F

¹² Introduced with Tinymesh release 1.52

Received Packet Formats

Packets received by the Gateway in Packet Mode, will be delivered on the module UART TXD-pin in the following formats. The packet Header is identical for all packet types, while the data payload formatting (starting at data byte # 18) will be formatted differently when receiving serial data and command responses requiring larger amounts of data.

Byte #	Field name	Size	Description
1	Start Character	1	Total number of bytes in the message, including start character
2	System ID	4	System-wide ID, must be identical for all devices in a system
6	Origin ID	4	Address of Router that created the message
10	Origin RSSI	1	RSSI from first receiver to originating node
11	Origin Network Level	1	'Hop' level, number of vertical hops to reach Gateway
12	Hop Counter	1	Number of actual hops from Router to Gateway
13	Message Counter	2	Unique number maintained by originating node
15	Latency Counter	2	Time in 10ms resolution from message creation to delivery
17	Packet Type	1	Event 2 (0x02) or Serial data in 16 (0x10)

General Event Packet Format (Packet Type 0x02)				
Byte #	Field name	Size	Description	
18	Message Detail	1	1 (0x01)	Digital Input Change Detected
			2 (0x02)	Analogue 0 Input Trig
			3 (0x03)	Analogue 1 Input Trig
			6 (0x06)	RF Jamming Detected
			8 (0x08)	Device Reset
			9 (0x09)	Status Message (IMA)
			10 (0x0A)	Channel is Busy with Similar System ID
			11 (0x0B)	Channel is Free
			12 (0x0C)	Channel is Jammed
			13 (0x0D)	Other Tinymesh™ System Active on this Channel
			14 (0x0E)	My System and Other System(s) Active on this Channel ¹³
			16 (0x10)	Command Received and Executed (ACK) ¹⁴
			17 (0x11)	Command Rejected, Not Executed (NAK) ¹⁴
			18 (0x12)	Status Message (NID)
19 (0x13)	Status Message Next Receiver			
19	Message Data MSB	1	Message Detail	Message Data
			1	0
			9	Configurable content, ref: IMA MESSAGE DATA FIELD CONTENTS 0: 0 (Default) 1: GPIO Trig Hold register 2: High Byte of 2-byte Pulse Counter 5: Device Connection status: ¹¹ 1. No alternatives on same hop level 2. Alternatives available, same hop level 3. Single Gateway 4. Gateway, alternative available 6: My Locator RSSI
			2,3,8,10,11, 12,13,16,19	0
			6	Jamming condition duration in minutes
			17	0 NAK response from Router- or End Device 1 (0x01): Bad Command packet length 3 (0x03): Bad Packet format 4 (0x04): Bad Gateway Command type 17 (0x11): Bad Config command 18 (0x12): Bad Secured Command Length
			18	UART flow control configuration
20	Message Data LSB	1	Message Detail	Message Data
			1	GPIO Trigger source, bit 7-0

¹³ Introduced with Tinymesh release 1.51

¹⁴ ACK and NAK messages from Gateway Device truncated after the Message Data Fields

General Event Packet Format (Packet Type 0x02)			
Byte #	Field name	Size	Description
			9 Configurable content, ref: IMA MESSAGE DATA FIELD CONTENTS 0: 0 1: 0 2: Low Byte of 2-byte Pulse Counter 5: 0 6: 0
			2,3,10,11, 12,13,18,19 0
			6 (0x06) Hours since jamming condition ended
			8 (0x08) 1 (0x01): Power On Reset 2 (0x02): External Reset (RESET input low) 3 (0x03): Reset from Sleep or Config Command 4 (0x04): Forced Reset by command 5 (0x05): Watchdog Reset
			16,17 User selected command number

21	Address(ID) Data	4	Message Detail	Message Data
			9 (0x09)	Configurable content, ref IMA MESSAGE ADDRESS FIELD CONTENTS 0: No Data 1: Pulse Counter (4 bytes) 2: Locator ID (4 bytes) 3: Destination ID (4 bytes) 4: Alternate Destination ID (4 bytes) ¹¹
			1-8 and 10-17 (0x0A)- (0x11)	Address of Locator Router with best received signal strength (RSSI)
			18 (0x12)	Gateway Network ID
			19 (0x13)	Address of first receiver in hop path
25	Module Temperature	1	Module Temperature, Ref TEMPERATURE READING (U-COMMAND)for value interpretation	
26	Module Voltage	1	Voltage/ Battery Monitor, ref. POWER SUPPLY VOLTAGE READING (V- COMMAND) for value interpretation	
27	Digital Inputs	1	GPIO 0-7	
28	Analogue 0	2	Analogue 0 converter, GPIO 0 (12 bits)	
30	Analogue 1	2	Analogue 1 converter, GPIO 1 (12 bits)	
32	HW version	2		
34	FW version	2		

Event Packet Format (Packet Type 0x02), Response to Get Path Command			
Byte #	Field name	Size	Description
18	Message Detail	1	32 (0x20) Get Path Response
19..23	Message Data	5	Byte number Content
			1 RSSI first jump
			2..5 First receiver ID
New entries of 5 bytes added per additional jump until packet is full (138 bytes) or last destination reached			
134..138	Message Data	5	Byte number Content
			1 RSSI Last jump
			2..5 Last receiver ID

Event Packet Format (Packet Type 0x02), Response to Get Configuration Memory Command			
Byte #	Field name	Size	Description
18	Message Detail	1	33 (0x21) Configuration Memory Dump
19-n	Message Data	Variable	Byte number Content
			1..n All bytes of accessible Calibration Memory

Event Packet Format (Packet Type 0x02), Response to Get Calibration Memory Command			
Byte #	Field name	Size	Description
18	Message Detail	1	34 (0x22) Calibration Memory Dump
19-138	Message Data	120	Byte number Content
			1..120 First 120 bytes of configuration memory

Serial Data Packet Format (Packet Type 0x10)			
Byte #	Field name	Size	Description

Serial Data Packet Format (Packet Type 0x10)			
18	Serial data block counter	1	0: Single data block, terminated by UART time-out. 1-255: Block (partition) number in large data streams controlled by CTS or Xon/Xoff handshake
19	Serial data	1..120	Serial data

Practical Use of Packet Header Data

The header section is identically formatted for all Tinymesh™ data packets. The header section contains valuable information for network quality analysis and data validation in a host system.

The four-byte SYSTEM ID uniquely identifies the network that originated the message and may be used as an identifier in host systems that handle multiple Tinymesh™ networks.

The UNIQUE_ID is unique address identifier of the device that originated the message, and an important identifier in a host system database.

The ORIGIN RSSI is the RF signal strength of the first link in the hop path for the message and is an indication of the quality of the first link. A high value, approaching the minimum level for reliable connection indicates poor connection, and may be an indication of poor connectivity with possibility for unreliable connection. An RSSI value above 190 is regarded as potentially too low for stable and reliable connection. The RSSI ACCEPTANCE LEVEL parameter in Configuration Memory determines the highest allowable link RSSI for establishing a new connection.

ORIGIN NETWORK LEVEL indicates the network hop level of the originating device at the time when the message was dispatched. As an example, if ORIGIN NETWORK LEVEL is 3, it indicates the packet will hop three times from the originating node, before reaching the Gateway. As a Tinymesh™ network inherently is a dynamical network that continuously adapts to changing RF conditions, it is possible that the packet may require more or less than the anticipated number of hops before reaching the Gateway. The actual number of hops travelled by the packet is indicated by the HOP COUNTER value that will increase by one each time the message is passed from one node to another.

The MESSAGE COUNTER is a unique, 16-bit number maintained by the originating node. Every message received by a host system may be uniquely identified by a combination of the SYSTEM ID, ORIGIN ID and MESSAGE COUNTER.

Note that the MESSAGE COUNTER is reset to zero after 64k packets, or after a device Reset. In practical implementations, it may be assumed that a new numbering sequence starts every time a DEVICE RESET message is received from the device. Reset messages will be generated after Power On, after a FORCE ROUTER RESET Command or after execution of a Device SET CONFIGURATION Command.

The LATENCY COUNTER is a 16-bit timer that is reset to zero when the packet is created, and maintained throughout the transportation chain until the message is delivered from the Gateway Device to the external host. The timer is updated at 10ms or 2560ms intervals, selectable by the MAX PACKET LATENCY TIME BASE parameter.

The timer will stop counting after reaching the maximum value. The message transportation delay is a good indicator of network reliability, and may be used in time critical implementations, to recreate an accurate time stamp for an event. Typical transportation delays in systems using default configuration settings may be expected to be less than 100ms per network hop.

Device and Network Status Interrogation

The Tinymesh™ protocol stack supports several optional commands for system and device status interrogation.

Automatic, time generated status messages may be generated by setting the IMA TIME parameter in Configuration Memory. For details, see AUTOMATIC STATUS REPORTING.

The GET STATUS, GET DID STATUS, and GET NID commands all return similarly formatted status messages with a payload portion containing the status of all input parameters: Analogue, Digital, Temperature and Supply Voltage.

The GET STATUS command returns a STATUS MESSAGE (IMA) event message, and may also be activated on an automatic time base by setting the IMA TIME parameter in Configuration Memory. The contents of the MESSAGE DATA MSB, MESSAGE DATA LSB and ADDRESS(ID) DATA packet fields is configurable through the IMA MESSAGE DATA FIELD CONTENTS and the IMA MESSAGE ADDRESS FIELD CONTENTS parameters.

The GET DID STATUS command returns a STATUS MESSAGE NEXT RECEIVER event message, containing the next receiver ID in the packet ADDRESS(ID) DATA field. Next Receiver is the preferred receiver of all communication from this node.

The GET NID command is only recognized by Gateway Devices, and returns a STATUS MESSAGE (NID) event message, containing the Gateway NETWORK ID in the packet ADDRESS(ID) DATA field.

The GET CONFIGURATION MEMORY command returns a CONFIGURATION MEMORY DUMP event message, a complete listing of the first 120 bytes of Configuration Memory of the addressed module. This command is useful for verification of individual configuration settings in the network.

The GET CALIBRATION MEMORY command returns a CALIBRATION MEMORY DUMP event message, a complete listing of the CALIBRATION MEMORY of the addressed module. This command is useful for verification of individual configuration settings in the network.

The GET PACKET PATH command returns a variable length payload, GET PATH RESPONSE event message. The payload contains the address and RSSI of all network hops from the original node to the Gateway. Note that in extremely large systems, the number of hops may exceed the maximum payload size of the packet. The maximum payload size is 120 bytes, allowing room for $120/5 = 24$ hops. In such events, the received message will contain all hops from original node until full packet, and a new Get Packet Path may be issued, addressing the last node in the previously received path.

Note: GET PACKET PATH commands will only return a valid path response when executed in unencrypted systems.

Serial Data Block Counter

The Tinymesh™ protocol stack supports long data frames and streamed data. The SERIAL DATA BLOCK COUNTER found in serial data packets in packet mode, indicates if the received data belongs to a larger stream of serial data, or if the delivered data is a single delivery. If the SERIAL DATA BLOCK COUNTER is zero (0), the delivered data is a single packet, generated by the Router- or End Device after detecting a time-out on the serial port, but before a 'buffer almost full condition' was signalled through CTS Off or Xoff (See SERIAL PORT HANDSHAKE).

If the SERIAL DATA BLOCK COUNTER is 1 or higher, the delivered data is part of a larger stream of data, and the block counter value is an indication of the sequence of the received data. The block counter will roll over to 1 after reaching the maximum value of 255 and will automatically be reset to 0 after receiving the last packet of a data stream.

Locator Function

Any Router or Gateway may be configured as a 'Locator' by setting the LOCATOR_ENABLE parameter. By default, the Locator function is disabled (0). Router devices will continually be listening and waiting for incoming data. In this process, the Router device will pick up packets originating from any Locator Device within RF reach. Router devices will always remember the UNIQUE_ID of the Locator Device with the lowest (best) RSSI.

Every time a Router Device dispatches a packet with GENERAL EVENT PACKET FORMAT, the ADDRESS(ID) DATA field will contain the UNIQUE_ID of the Locator Device within closest radio range (best RSSI) of the Router.

A GENERAL EVENT PACKET FORMAT Event message may be triggered on a timely basis by setting the IMA TIME parameter, through a request command from the Gateway, or be triggered by a digital- or analogue input level shift.

The Locator feature may be utilized in systems designed for asset tracking or other locating functions. Router Devices placed in fixed, known locations should then be set as Locator devices. Portable devices or devices with unknown location should have the Locator bit disabled.

Network Busy Detection

Gateway Devices may be set to monitor and report network activity before starting to build the mesh network. In some applications using ad hoc networks with, for instance, portable Gateway Devices, it may be important for the operation of the systems that only one Gateway Device is active at any time.

By enabling the DETECT NETWORK BUSY parameter, the Gateway Device will either monitor and report status before building the network, or may optionally refrain from building the network if competing activity is discovered.

Network ID

The NETWORK ID Calibration Memory Parameter is intended for host systems operating multiple mesh networks, such as the Tinymesh Cloud platform. For stand-alone systems, the SYSTEM_ID is sufficient for identifying devices belonging to a system.

When deploying Internet based host platforms, there may already exist deployed networks with identical SYSTEM_ID settings. To be able to uniquely distinguish between co-existing systems with identical SYSTEM_ID, the Gateway Device may be configured with a unique, four byte NETWORK ID, allocated by the hosting system.

A host system may request the Gateway NETWORK ID by sending a GET NID command to NODE ADDRESS 0 0 0 0. The Gateway Device will respond with a STATUS MESSAGE (NID) event packet, containing the NETWORK ID in the ADDRESS(ID) Data field.

The NETWORK ID is stored in the module CALIBRATION MEMORY, and will be retained after a RESET MEMORY factory reset command.

The WRITE CONFIGURATION MEMORY command must be used to change the value of the NETWORK ID. The module must be set to CONFIGURATION MODE, and the SETTING AND CHANGING THE NETWORK ID (NID) procedure should be used to change the NID.

IMA On Connect Function

A Router Device may be set to send a STATUS MESSAGE (IMA) report every time it connects to the mesh network. This function may be useful in networks that are normally inactive, and that are temporarily formed by introducing a Gateway Device, e.g. for data collection when using a hand held Gateway.

The host system will receive a STATUS MESSAGE (IMA) messages every time a new device connects to the network, and may successively build a complete list of connected devices by storing the ORIGIN ID found in the header of each received packet.

Enable the IMA On Connect feature by changing the IMA ON CONNECT configuration setting.

Automatic Status Reporting

Tinymesh™ networks provide efficient mechanisms for automatic, time generated status reporting, automatic messaging on analogue or digital input status change and automatic data transmission on serial data (UART) input. Automatic status and event reports should be considered as an alternate and more efficient system design than traditional status polling. Poll commands from a master will occupy valuable RF bandwidth, limiting the data throughput and responsiveness in a mesh system. In contrast to protocols normally employed in wired multi-drop systems, a Tinymesh™ network allows any device to initiate

communication as long as the communication media (the RF channel) is free. The local intelligence embedded in Tinymesh™ devices automatically handles the access to the shared RF channel by CSMA (Carrier Sense Multiple Access), eliminating the need for a polling master controller.

Automatic, time generated status messages may be generated by setting the IMA TIME parameter in Configuration Memory. The IMA timer is a single byte timer, with selectable time base. The time base may be set from 10 to 2550 seconds by changing the value of the IMA TIME BASE parameter. The default setting of 6 provides a one-minute resolution for the IMA timer. Time generated messages may be used for data logging purposes, and as a means to keep track of the on-line status of devices. If the Routers or End Devices are set to report status once in a given time interval, a host system may routinely check that all devices have reported back within the time window and generate an alert if status messages are missing.

Analogue and digital inputs may be set to trigger event messages on pre-determined status changes. Event messages triggered by input status changes will be transmitted immediately, providing a more responsive approach than what may be achieved in a traditional, polled system.

Please reference the chapters ANALOGUE Input Event Triggering and DIGITAL INPUT for in-depth information on configuring the inputs for automatic event triggering.

All event message packets contain by default the current value of Digital and Analogue inputs, module temperature, module voltage and the address of the closest Locator Device.

Serial data entered on the device UART will automatically trigger a serial data transmission when the serial data buffer is full, or after a configurable time-out between bytes.

Receive Neighbour Function

Tinymesh™ Router Devices in live networks with an active Gateway Device, may be configured to accept messages dispatched by neighbour devices, for direct output of the received data to the UART, formatted as RECEIVED PACKET FORMATS.

The RECEIVE NEIGHBOUR MESSAGES parameter must be set to 1 to enable this function. A neighbour device is defined as any device that is within direct link of the Router Device. By enabling this function, a Router Device will copy all received data packets originating from any neighbouring device to its serial port. Data will be delivered in the standard packet format, similar to data received by a Gateway Device.

Note: Data is verified for integrity before accepted, but there is no retransmission nor acknowledge handshake for this mode.

The Receive Neighbour function may be useful for home control or simple applications where direct control from one device to another, nearby device is desirable. An external MCU may be programmed to interpret the received data packet and perform actions determined by the received data.

Example: The received data is a GPIO trig message indicating that the transmitting Router has detected an input signal transition on a GPIO. The receiving application may interpret this signal as a command to turn on/ off a function, such as a light source.

Input / Output Functions

Tinymesh™ modules have eight connection pins for application Input / Output control, in addition to the dedicated PULSE COUNTER input and the UART serial port.

The Gateway Device must be configured for PACKET MODE OPERATION to support the Input / Output functions. Sampled analogue and digital GPIO values may be found in all GENERAL EVENT PACKET FORMAT received from Router- or End devices.

Outputs may be controlled by the SET OUTPUTS and SET PWM commands from the Gateway. Routers- and End Devices will trigger event packet delivery from several sources:

- By an analogue input signal changing value (ANALOGUE INPUT)
- A digital input changing value (DIGITAL INPUT)
- A timed event (AUTOMATIC STATUS REPORTING)
- By a request command from Gateway (GET STATUS)

By default, all eight GPIO pins are inputs. Any of the GPIOs may however be changed to function as outputs with default high- or default low level.

Additionally, GPIO 0 and 1 may be configured to function as analogue inputs, and GPIO 7 may be used for 0-100% duty cycle PWM output.

Each GPIO pin is supported by individual configuration settings for function selection (GPIO) and (GPIO TRIG) condition.

Digital Input

When a GPIO has been configured to act as an input through the GPIO configuration setting, a separate GPIO TRIG configuration setting is used to determine if the input signal should be used to trigger an event message. The trigger function may for instance be used to trigger an alarm condition. The configuration settings allow for triggering on digital signals when changing from high to low level, from low to high, or both. The default setting is *no trig*. Digital inputs are pre-configured with a 20k pull-up resistor. See the GPIO pin description.

With no external signal connected, a digital input will always read as digital '1' in Event Messages.

Digital Input De-bouncing

Digital inputs are protected by a de-bounce mechanism, to eliminate problems with unstable signals or settling times for micro switches or detectors. The de-bounce setting is common for all digital inputs, and settable in intervals of 1ms by changing the INPUT DE-BOUNCE Configuration Parameter. The default setting is 10ms, meaning that any digital input must deliver a stable input (no change) for at least 10ms, to trigger an event.

Digital Input 'Trig Hold'

The TRIG HOLD function creates an 8-bit bitmap of inputs that have been triggered (meeting configured digital input GPIO trig conditions) during the last IMA TIME sampling period.

The 'Trig Hold' data may be included in the STATUS MESSAGE (IMA) packets by changing the default configuration of the IMA MESSAGE DATA FIELD CONTENTS .

The trig hold function is useful in data logging applications where several similar trigger events may occur over a time period, but the transmission of all event messages would introduce unnecessarily high levels of data traffic.

Pulse Counter

The pulse counter function uses a separate PULSE COUNTER input, not shared by the eight configurable GPIO inputs. The pulse counter is enabled by changing the PULSE COUNTER MODE configuration.

The pulse counter is a four-byte rolling counter, set to zero at module Reset. The current counter value is reported by the STATUS MESSAGE (IMA) event, that may be triggered either

on a timed basis by setting the IMA TIME parameter, or by issuing a GET STATUS command from the Gateway.

The counter status may be viewed either in a two-byte format, by selecting the IMA MESSAGE DATA FIELD CONTENTS parameter = 2, or in a four byte format, by setting IMA MESSAGE ADDRESS FIELD CONTENTS⁹ = 1

Pulse Counter De-bounce

The pulse counter de-bounce feature is enabled by setting the PULSE COUNTER DEBOUNCE parameter to the desired de-bounce time in milliseconds. Transitions on the pulse counter input during the settable de-bounce period will be ignored, and a valid pulse must be at logical low level at the end of the de-bounce period.

Pulse Count Verification

The PULSE COUNTER FEEDBACK INDICATOR option is a support function to verify proper pulse counting. The feedback signal may be used to drive for instance a high efficiency LED for instant verification of pulse detection.

Note: The output drive capability of the output is limited, as indicated in the DIGITAL OUTPUT DRIVE paragraph.

The feedback signal is controlled by the module pulse count firmware, and is therefore a true representation of pulse detection, and may be used for field test calibration by for instance applying an oscilloscope to the pulse source and the feedback output. The feedback output signal has a total duration of minimum 4ms, maximum 5ms, and is triggered at the same time as the module performs the sampling of the input signal level.

Note: When the pulse counter function is used in an End Device, the duration of the feedback indicator signal will be truncated at the time the module returns to sleep mode, and will therefore only be active for a few microseconds (us), or for the duration of the PULSE COUNTER DE-BOUNCE period.

The following Configurable parameters are used to control the Pulse Counter Feedback feature:

- Enable Pulse Counter Feedback by setting the FEEDBACK ENABLE parameter = 2.
- Enter the GPIO number (0-7) selected for the FEEDBACK PORT.
- Configure the selected GPIO as Output by changing the appropriate GPIO function.

Note: Duration of the Pulse Counter Feedback Indicator function is controlled by the INDICATORS ON parameter. Pulse Counter Feedback will terminate when Indicators are off.

Digital Output control

Digital outputs are controlled by Gateway commands, using the SET OUTPUTS and TOGGLE OUTPUTS Commands. The designated GPIOs must first be enabled as outputs, by configuring the desired GPIO function. The Default configuration is Input. A command to set, reset or toggle a GPIO that has not been configured for Output control will have no effect. The default output value at Reset is selectable in the GPIO configuration.

Set Output Comand

The DATA 1 and DATA 2 bytes in the COMMAND PACKET FORMAT are used to control the output status. The contents of these bytes are 'bit mapped', such that the first bit of the byte controls the output status of GPIO 0, and the 7th bit of the byte is used to set GPIO 7. DATA 1 is used for **setting** outputs, while DATA 2 is used for **clearing** outputs.

Note that setting a bit in DATA 2 (Clear output) will override a bit that has been set in DATA 1 (Set Output). By using two separate bits for setting/ clearing an output, the external application firmware may be relieved of the task of knowing the previous state of a digital output, because only the single bits selected by the command will be affected.

Example 1: Set GPIO Outputs 5 and 7

Command Data byte 1								Command Data byte 2							
Bit 7	Bit 6	Bit 5	Bit 4	Bit 3	Bit 2	Bit 1	Bit 0	Bit 7	Bit 6	Bit 5	Bit 4	Bit 3	Bit 2	Bit 1	Bit 0
1	0	1	0	0	0	0	0	0	0	0	0	0	0	0	0

GPIO Output							
GPIO7	GPIO6	GPIO5	GPIO4	GPIO3	GPIO2	GPIO1	GPIO0
Set	No Change	Set	No Change	No Change	No Change	No Change	No Change

Example 2: Clear GPIO Output 3

Command Data byte 1								Command Data byte 2							
Bit 7	Bit 6	Bit 5	Bit 4	Bit 3	Bit 2	Bit 1	Bit 0	Bit 7	Bit 6	Bit 5	Bit 4	Bit 3	Bit 2	Bit 1	Bit 0
0	0	0	0	0	0	0	0	0	0	0	0	1	0	0	0

GPIO Output							
GPIO7	GPIO6	GPIO5	GPIO4	GPIO3	GPIO2	GPIO1	GPIO0
No Change	No Change	No Change	No Change	Cleared	No Change	No Change	No Change

Example 3: Command Data Byte 2 settings will override Command Data Byte 1 settings
Setting and clearing the same output, results in clearing the output:

Command Data byte 1								Command Data byte 2							
Bit 7	Bit 6	Bit 5	Bit 4	Bit 3	Bit 2	Bit 1	Bit 0	Bit 7	Bit 6	Bit 5	Bit 4	Bit 3	Bit 2	Bit 1	Bit 0
0	0	0	0	0	1	0	0	0	0	0	0	0	1	0	0

GPIO Output							
GPIO7	GPIO6	GPIO5	GPIO4	GPIO3	GPIO2	GPIO1	GPIO0
No Change	No Change	No Change	No Change	No Change	Cleared	No Change	No Change

Toggle Output Command

The TOGGLE Outputs command provides a timed pulse output on any GPIO configured as Output.

The DATA 1 byte in the SET OUTPUTS COMMAND PACKET FORMAT selects the desired GPIO(s). The format is 'bit mapped', such that the first bit of the byte controls the status of GPIO 0,

and the 7th bit of the byte is used to control GPIO 7. The DATA 2 byte sets the toggle time in milliseconds

Regardless of previous output state, the TOGGLE Outputs command will force the selected GPIO(s) to temporarily change state for a period of 1 to 255 ms

Digital Output Drive

GPIO 0 - 7, when configured as outputs, are capable of sinking or sourcing 2mA, which is sufficient for driving a transistor or some high efficiency LEDs. When used to drive higher loads, the outputs must be buffered by a transistor or similar, to provide sufficient drive current.

The two dedicated RSSI/ TX LED and CONNECTION/ RX LED outputs have higher drive capacity, and should be limited by an external resistor for a maximum sink or source load of 10mA.

PWM (Dimmer) Output

GPIO 7 may be configured for PWM output (Pulse Width Modulation), and used for light dimming or motor speed control, by setting GPIO 7 CONFIGURATION = 3.

SET PWM commands will control the duty cycle of the GPIO 7 output from 0 to 100%, providing full range dimming control from fully off to fully on.

The default PWM value at Reset is configurable to any value between 0 to 100% by setting the PWM DEFAULT parameter in Configuration Memory. The factory setting is 0.

The PWM switching frequency is fixed at 1 kHz

Analogue Input

The TinyMesh™ module features two independent analogue inputs. The analogue function of GPIO 0-GPIO 1 may be individually enabled by changing the default configuration setting of GPIO 0 CONFIGURATION and GPIO 1 CONFIGURATION. The analogue inputs will be sampled at a sampling rate as defined by the GPIO 0 ANALOGUE SAMPLING INTERVAL and GPIO 1 ANALOGUE SAMPLING INTERVAL configuration settings. The Sample Rate may be set in increments of 10ms. The default setting is 100, or one sample per second. The analogue value is calculated as a sliding average of the last eight samplings. The analogue converters are pre-configured to use an internal 1.25V voltage reference. A positive input voltage between 0 and 1.25V applied to an analogue input pin will be converted to a positive number between 0 and 2047 (0x07FF). Out of range values will be reported as either 0 or 2047.

The analogue voltage value of the input signal may be calculated as:

Example:

	Analogue voltage = Measured Value * 1.25 / 2047 [V]	
Measured Value:	0x4CC	
Convert to decimal:	0x4CC = 1228	
Analogue voltage conversion:	1228*1.25 / 2047= <u>0.75 [V]</u>	

Please note that negative voltages or voltages above the module supply voltage may result in permanent damage to the module, please reference the electrical specifications for details.

Analogue Input Event Triggering

The two analogue inputs GPIO 0-GPIO 1 may be set to trigger ANALOGUE 0 INPUT TRIG or ANALOGUE 1 INPUT TRIG event messages when the measured analogue values exceed or go below defined threshold values. Configurable analogue High and Low settings may be used to create a hysteresis, to avoid multiple messages to be generated if the analogue signal changes very slowly over time, or is following a non-linear curve. This will typically be the situation when analogue inputs are used to sense temperature variations or battery voltage. By setting the GPIO ANALOGUE HIGH, and ANALOGUE LOW Trig thresholds to different values, an event message will be triggered when the sampled analogue signal passes through the hysteresis, from below the low trig value to above the high trig value, or vice versa. Please see below examples for clarification.

Low- to high trigger

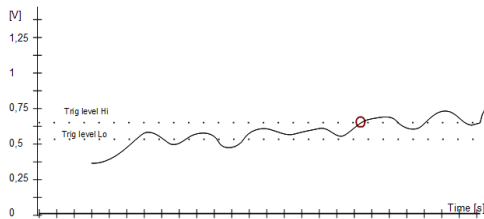

High- to low trigger

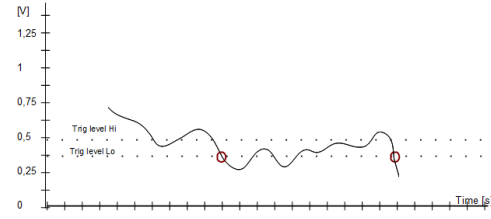

Setting the Analogue Input Trigger Level

The analogue high and the low trigger level threshold values must be entered as two-byte values in the GPIO analogue trigger parameters in Configuration Memory. The maximum trigger level values are 2047, or Hex 0x7FF, entered as High byte = 0x07, and Low byte = 0xFF.

Calculate the Trigger Value as: $\text{Trigger Value} = \text{Analogue trigger voltage} * 2047/1.25$

Example: Analogue trigger voltage = 0.75[V]

First find the Trigger Value = $0.75 * 2047 / 1.25 = \underline{1228}$

Divide the Trigger Value by 256 to find the Trigger High Byte value:

$1228 / 256 = 4.796 \Rightarrow \text{High Byte} = \underline{4}$

Then calculate the Low Byte value by subtracting the value of the High Byte from the Trigger Value:

$1228 - (4 * 256) \Rightarrow \text{Low Byte} = \underline{204}$ (Hex 0xCC).

Note: GPIO 0-GPIO 1 are both pulled high by an internal 20k resistor when used for digital input or output. The internal pull-up is disabled when used as analogue inputs, causing the impedance of the analogue inputs to be in the +100kohm range.

Setting the Analogue Input Sampling Interval.

The analogue sampling interval may be set in steps of 10ms, by changing the GPIO 0 ANALOGUE SAMPLING INTERVAL or GPIO 1 ANALOGUE SAMPLING INTERVAL for values between 0.01s and 2.55s. The analogue measurement value is calculated as the sliding average value of the last eight samples. The sliding average and the sampling interval may be used as a filter function to eliminate spurious glitches in the measured voltage. The default sampling interval is set for 1 second.

End Device

A Tinymesh™ module may be configured to function as an End Device by issuing the SET END DEVICE MODE command from Configuration Mode.

On initial wakeup, the End Device will make a connection to the mesh by going through a normal network connection procedure, similar to a Router Device.

When a connection has been established, the End Device will return to sleep mode, and only wake up when one or more of the configured wakeup conditions have been met.

On subsequent wake-ups, the module will assume the previous binding still exists, transmit data if required, wait for receipt acknowledgement and resume sleep.

If no acknowledgement is received after RF TRANSMIT RETRY LIMIT retries, the End Device will attempt to create a new binding on next wakeup, unless the End Device has been configured for connection to a FIXED DESTINATION ID. If no valid connection has been established during a period of 2 X CONNECT CHECK TIME, the End Device will return to sleep, and repeat the reconnect attempt on next wake up.

On wakeup, the End Device will dispatch a message identifying the wakeup source, except for wake-ups caused by the Pulse Counter input.

Before returning to sleep mode, the End Device will stay awake for a configurable END DEVICE WAIT FOR COMMAND time, allowing an external application to act on the received data and dispatch a serial data- or command- packet to the End Device.

End Devices will normally be in low power sleep mode, and may be configured to wake from sleep from a number of different input sources:

- Pulse Counter Input
- Digital Input trigger
- Serial port (UART) input
- Timed Wakeup

Enable the desired wakeup source by setting the appropriate bits of the END DEVICE WAKEUP ENABLE parameter. The END DEVICE WAKEUP ENABLE parameter is a bitmap of the different input conditions allowed to wake the End Device. The default setting after configuring the End Device with the SET END DEVICE MODE- Command, is Timed Wakeup with IMA TIME = 10. On Timed Wakeup, the End Device will send a STATUS MESSAGE (IMA) MESSAGE before returning to sleep.

Additional to selecting the End Device wakeup sources, the END DEVICE WAKEUP ENABLE parameter may be used to enable a timer function that forces the End Device to stay awake and receive incoming Locator Beacons for a full HIAM time period, before dispatching data. See LOCATOR FUNCTION for detailed information.

The different wakeup conditions each have different bitmap values. When setting up for multiple simultaneous options, enter the sum of the bitmap values:

Wakeup Source	Bit value	Example Settings			
		Pulse Counter + Timer	Serial Port	Digital Input	Detect and dispatch locator address
Pulse Counter	1	1			
Digital Input	2			2	
Serial Port	4		4		
Timer	8	8			8
Wait for Locator Beacon	128				128
Wakeup Enable Parameter Value		9	4	2	136

Wake Up from Pulse Counter

Pulses detected by the pulse counter will wake the module when the pulse counter function has been enabled. As a basis for power consumption calculations, the awake-time without De-bounce Timing is on average 3ms per pulse.

With De-bounce Timing active, the awake-time increases to PULSE COUNTER DEBOUNCE Time + 3ms.

The average power consumption in while Active Mode is 5mA.

Enable Pulse Counter wakeup by setting bit #0 (adding the value 1) to END DEVICE WAKEUP ENABLE configuration parameter

On wakeup from the pulse counter, the module will not dispatch data, but return directly to sleep mode after detecting the pulse.

Wake Up from Digital Input

Enable the Digital Input wake up by setting bit #1 (adding the value 2) to the END DEVICE WAKEUP ENABLE configuration parameter.

On wakeup, the module will dispatch a DIGITAL INPUT CHANGE DETECTED event message.

Set the GPIO TRIGGER CONDITION for the GPIOs that shall be used for module wakeup for High- Low triggering.

Note: Only High - Low triggers will wake the module from sleep.

Wake Up from Serial Port UART

Enable wake up by setting bit #2 (adding the value 4) to the END DEVICE WAKEUP ENABLE configuration parameter.

On wakeup, the module will dispatch a Serial Data packet, containing the received serial data.

Note: The module will require time to wake up from detecting the start bit of the incoming serial data. Any data entered on the serial port while module is in sleep mode, must be preceded by a single '0xFF' byte.

Wake Up from IMA Timer

End Devices may be set to wake up and transmit a STATUS MESSAGE (IMA) at timed intervals.

Enable Timed Wakeup by setting bit #3 (adding the value 8) to the END DEVICE WAKEUP ENABLE configuration parameter.

On wake up, the module will dispatch a STATUS MESSAGE (IMA) event message.

The time base for the IMA timer is controlled by the 10-seconds IMA TIME BASE parameter.

The default setting for the IMA TIME BASE parameter is 6, providing a time base of $6 \cdot 10 = 60$ seconds for the IMA TIME.

Single second time resolution is obtained by setting IMA TIME BASE = 0. By selecting '0' for the IMA Time Base, the End Device will always spend shortest possible time returning to sleep mode, regardless of wake up source, thereby reducing power consumption to a minimum, while maintaining longest possible life expectancy for the battery. Please refer BATTERY LIFETIME CONSIDERATIONS for detailed information.

Examples:

To set 30 seconds time interval, set IMA TIME BASE = 0 and IMA TIME = 30

To set 20 minutes time interval, set IMA TIME BASE = 6 and IMA TIME = 20

To set 24 hour time interval, set IMA TIME BASE = 180 and IMA TIME = 48

Note: When Timed Wakeup is not in use, set IMA TIME BASE = 0 to minimize power consumption

Battery Lifetime Considerations

While in sleep mode, the power consumption of the End Device will be 0.5uA if the Sleep Timer function is active and 0.3uA if the Sleep Timer is disabled. This consumption level is less than the typical leakage current of most batteries.

Note: The sleep current estimates are based on an assumption that all GPIO pins are either configured as outputs and are either left floating or pulled high if configured as inputs. The internal pull-up is enabled for all GPIOs that are configured as inputs, to enable wake-up from high- to low transitions. The same applies for the RTS/SLEEP input, the RXD input and the CONFIG input.

The determining factor is going to be how often the module is awake, for how long time, and what is the power consumption of the module plus interfacing circuits while the module is awake.

Number of instances	Module type	
	Low Power	High Power
Pulse Counts with De-bounce Timer off Wake Time Res = 0 Wake Time Res = 6	10 000 000 600 000	10 000 000 600 000
Pulse counts with De-bounce Timer = 10ms	140 000	140 000
Message Transmissions in Walk by Mode	30 000	2 100
Message Transmission with Acknowledge in live mesh network	5 500	1 600

Key figures, instances per consumed mAh. Assumptions: RF Data Rate 5, RF POWER 5.

Analogue Port Sampling by End Devices

The Sliding Average function, employed when analogue ports are sampled by Router- and Gateway Devices (ANALOGUE INPUT), will not be activated by End Devices, as the time required for the sliding average calculation would require the module to be kept awake, and power consumption would be too high for normal battery operation.

When analogue port sampling is activated, by GPIO 0 or 1 set for Analogue Input, the module will stay awake for at least one GPIO 0 ANALOGUE SAMPLING INTERVAL, or GPIO 1 ANALOGUE SAMPLING INTERVAL to allow a timed STATUS MESSAGE (IMA) message to represent the current status of the active analogue port(s).

Module Awake Output Function

In End Device applications, there will often be a need to power up external sensor devices only while the module is awake. While in sleep mode, such sensors may represent an undesirable power consumption, and should be switched off.

The Tinymesh™ module supports external device power control by the Module Awake Function. A dedicated GPIO output will go low on module wake-up, and return high as the module returns to low power sleep mode. This output may be used to switch off power to external devices, e.g. using a MOSFET transistor as the power switch.

Enable the Module Awake Function by selecting the desired GPIO port in the END DEVICE AWAKE PORT parameter. Also, remember to activate the same GPIO for output function by setting the port GPIO configuration for the port to act as a normally high output

Fixed Destination and “Walk By” Mode

End Devices and Routers may be configured to assume a permanent connection to a pre-defined device UID.

When the FIXED DESTINATION ID parameter in CALIBRATION MEMORY has been changed to a value different from the default 0 0 0 0 setting, the Router or End Device will always attempt delivery of data packets to this UID, regardless of whether the previous delivery was acknowledged or not.

If no Acknowledge is received, the Router or End Device will attempt delivery RF TRANSMIT RETRY LIMIT number of times before giving up. The End Device will then return to sleep, while a Router will discard the packet as undeliverable.

The 'Walk By' mode is a variety of the Fixed Destination setting. 'Walk By' is enabled by selecting the broadcast address '255 255 255 255' as the FIXED DESTINATION ID. By enabling 'Walk By', the Device will skip waiting for receipt acknowledge of dispatched data, and End Devices immediately return to sleep mode after transmitting a data packet. The Walk By function works for all types of message dispatches from a device, either the message is from serial data received on the UART, a status-triggered message or generated by the internal IMA timer.

Walk By is typically applied for metering- and pulse counter applications, where updated STATUS MESSAGE (IMA) messages should be transmitted at regular time intervals.

The STATUS MESSAGE (IMA) event message contains current status of all digital- and analogue inputs, module temperature and module voltage level, as well as the current status of the pulse counter, either in 2- or 4-byte format.

Receive and Transmit Timing

The figures and tables below show the timing information for the module when changing between different operating states.

RXD and TXD are processes for receiving or transmitting UART data. The UART operates in full duplex, allowing simultaneous serial transmit and receive between the module and a host processor.

RX and TX are radio states, in which the built in radio transmitter is busy either receiving or transmitting data.

Receive RF Packet Timing

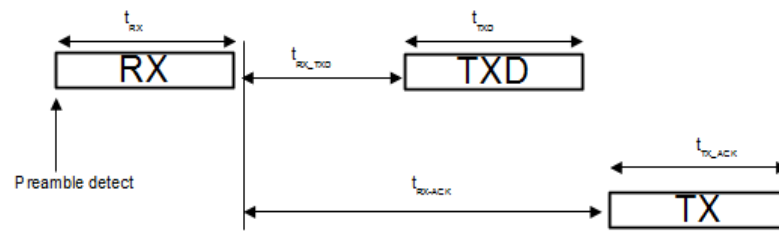

Tiny Mesh RF Receive timing diagram

Symbol	Value	Description / Note
t_{RX}	Serial data: 3.5 - 16ms Event packet: 5.1 ms	Time from preamble detected until packet received.
t_{RX_TXD}	Max 1 ms	Time from packet fully received until first character sent to UART
t_{TXD}	Min 521 us	Number of bytes x 521 us
t_{RX_ACK}	2 ms - 33 ms	Time from packet fully received until Acknowledge message ready to be transmitted, including LBT and random MAC timing
$t_{TX(ACK)}$	3.2 ms	Time to transmit ACK packet, including preamble and sync

Note: Timing diagram representative for packet transmission without collision and retry, and no wait for clear channel delay.

UART Receive and CTS Timing

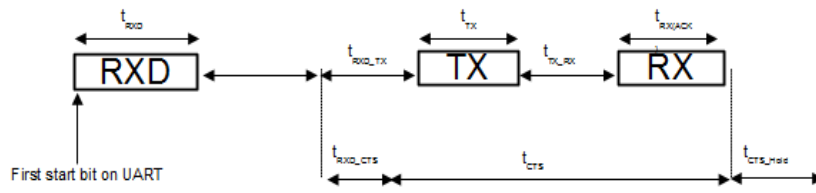

Tiny Mesh UART receive and CTS timing diagram

Symbol	Value	Description / Note
t_{RXD}	Min 521 us	Number of bytes in message x 521 us
$t_{Packet_Timeout}$	min 0, max 255 ms	Configurable 10-2550 ms. No time out if buffer is filled (120 bytes).
t_{RXD_TX}	2 - 32 ms	Time from serial data received on UART until packet ready to be transmitted, including LBT and random MAC timing
t_{TX}	4.3-16.8 ms	Time to transmit packet, including preamble and sync. Transmit time = 4.3ms + number of bytes* 0.104ms
t_{TX_RX}	2 - 32 ms	Time from RF packet transmitted until Acknowledge preamble detected. Time equals t_{RX_ACK} in Receiver RF Packet timing diagram
$t_{RX(ACK)}$	3.2 ms- 16.8 ms	Time to receive and verify Acknowledge packet Router: 3.2 ms, Gateway 4.3-16.8 ms, depending on packet size.
t_{RXD_CTS}	10 us	Time from buffer full or time-out, until CTS high
t_{CTS}	9.5- 82 ms	Time from CTS Off until Acknowledge received= $t_{RXD_TX} + t_{TX} + t_{TX_RX} + t_{RX(ACK)} - t_{RXD_CTS}$
t_{CTS_Hold}	min 10, max 2550 ms	Time from Acknowledge received until CTS low CTS HOLD TIME parameter. Not applicable for Router Devices

Note: Timing diagram representative for packet transmission without collision and retry, and no wait for clear channel delay.

Examples:

120 bytes serial data entered on Router UART @ 19.2 kbit/s, RF rate=76.8 kbit/s
Time from first start bit enters UART until packet delivered and CTS released (on):
min: $(120 \times 0.521) + 0 + 2 + 16.8 + 2 + 3.2 = 86.5$ ms
max: $(120 \times 0.521) + 0 + 32 + 16.8 + 32 + 3.2 = 146.5$ ms

10 bytes serial data entered on Router UART @ 19.2 kbit/s, RF rate=76.8 kbit/s, packet time-out = 10 ms. Time from first start bit enters UART until packet delivered and CTS released (on):
min: $(10 \times 0.521) + 10 + 2 + 5.3 + 2 + 3.2 = 27.7$ ms
max: $(10 \times 0.521) + 10 + 32 + 5.3 + 32 + 3.2 = 87.7$ ms

10 bytes serial data entered on Gateway UART @ 19.2 kbit/s, RF rate 76.8 kbit/s, packet time-out = 10ms, CTS_Hold = 10ms. Time from first start bit enters UART until packet delivered and CTS released (on):
min: $(10 \times 0.521) + 10 + 2 + 5.3 + 2 + 5.3 + 10 = 39.8$ ms
max: $(10 \times 0.521) + 10 + 32 + 5.3 + 32 + 5.3 + 10 = 99.8$ ms

Memory Configuration Timing

CONFIG is the operating state entered by asserting the CONFIG pin, and is used during parameter configuration over the UART port. MEMORY CONFIG is a sub-state entered by the 'M' command where the configuration memory is being programmed.

Note the limitation on maximum number of write cycles using the 'M' command, see Electrical Specifications.

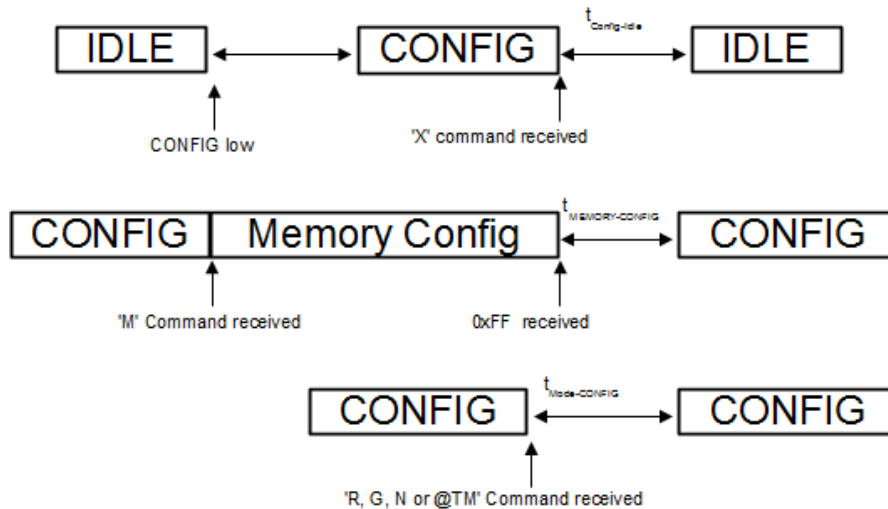

Configuration Mode Timing

Symbol	Value	Description / Note
$t_{\text{RESET-IDLE}}$	3.3 ms	Time from power up reset to module in normal. Idle mode
$t_{\text{CONFIG-PROMPT}}$	1 ms	Time from CONFIG pin is set low until prompt (">")
$t_{\text{MEMORY-CONFIG}}$	24 ms (FLASH ERASE DELAY+ 24ms)	In this period, the internal flash is programmed. <i>Do not reset, turn the module off, or allow any power supply dips in this period as it may cause permanent error in the Flash configuration memory. After 0xFF the host should wait for the '>' prompt before any further action is done to ensure correct re-configuration.</i> <i>From FW version 1.51, a configurable 0-255ms delay prior to all flash writes has been introduced to prevent issues during power up reset in noisy environments. Default delay is 0 ms for backwards compatibility</i>
$t_{\text{Mode-CONFIG}}$	24 ms (FLASH ERASE DELAY+ 24ms)	Ref $t_{\text{MEMORY-CONFIG}}$
$t_{\text{Command-Response}}$	10 us	Time from end of command byte to start of response byte received on UART on all commands except R, G, N and memory configuration commands.
$t_{\text{CONFIG-IDLE}}$	1 ms	Time from 'X' command until module in normal operation

RF Frequencies, Output Power and Data Rates

The following table shows the available RF channels and their corresponding RF-Frequencies, nominal Output Power levels and available Data Rates.

Article Number	RF Channel ¹⁵	Data Rate ¹⁵	Modulation	Output Power ¹⁵
RC114x-TM	1: 433.100 MHz 2: 433.200 MHz 3: 433.300 MHz 4: 433.400 MHz 5: 433.500 MHz 6: 433.600 MHz 7: 433.700 MHz 8: 433.800 MHz 9: 433.900 MHz 10: 434.000 MHz 11: 434.100 MHz 12: 434.200 MHz 13: 434.300 MHz 14: 434.400 MHz 15: 434.500 MHz 16: 434.600 MHz 17: 434.700 MHz	1: 1.2 kbit/s 2: 4.8 kbit/s 3: 19.0 kbit/s 4: 32.768 kbit/s 5: 76.8 kbit/s 6: 100 kbit/s 7: For future use 8: 50kbit/s	GFSK GFSK GFSK GFSK GFSK GFSK GFSK	1: -20 dBm 2: -10 dBm 3: 0 dBm 4: 5 dBm 5: 11 dBm
RC117x-TM RC117xHP-TM ¹⁶	1: 865.100 MHz 2: 865.300 MHz 3: 865.500 MHz 4: 865.700 MHz 5: 865.900 MHz 6: 866.100 MHz 7: 866.300 MHz 8: 866.500 MHz 9: 866.700 MHz 10: 866.900 MHz 11: 867.100 MHz 12: 867.300 MHz 13: 867.500 MHz 14: 867.700 MHz 15: 867.900 MHz	1: 1.2 kbit/s 2: 4.8 kbit/s 3: 19.0 kbit/s 4: 32.768 kbit/s 5: 76.8 kbit/s 6: 100 kbit/s (N/A for HP version) 7: For future use 8: 50kbit/s	GFSK GFSK GFSK GFSK GFSK GFSK	RC117x-TM 1: -20 dBm 2: -10 dBm 3: 0 dBm 4: 5 dBm 5: 11 dBm RC117xHP-TM 1: 0 dBm 2: 10 dBm 3: 14 dBm 4: 25 dBm 5: 27 dBm
RC118x-TM ¹⁷ RC118xHP-TM ^{18,17}	1: 868.050 MHz 2: 868.150 MHz 3: 868.250 MHz 4: 868.350 MHz (RC1180-TM) 5: 868.450 MHz 6: 868.550 MHz 7: 868.650 MHz 8: 868.750 MHz 9: 868.850 MHz 10: 868.950 MHz 11: 869.050 MHz 12: 869.150 MHz 13: 869.525 MHz (RC1180HP-TM) 14: 869.750 MHz 15: 869.850 MHz 16: 869.950 MHz 17: 869.475 MHz 18: 869.575 MHz	1: 1.2 kbit/s 2: 4.8 kbit/s 3: 19.0 kbit/s 4: 32.768 kbit/s 5: 76.8 kbit/s 6: 100 kbit/s ¹⁹ (N/A for HP version) 7: For future use 8: 50kbit/s	GFSK GFSK GFSK GFSK GFSK GFSK	RC118x-TM 1: -20 dBm 2: -10 dBm 3: 0 dBm 4: 5 dBm 5: 11 dBm RC118xHP-TM 1: 0 dBm 2: 10 dBm 3: 14 dBm 4: 25 dBm 5: 27 dBm

¹⁵ RF Channel, Output Power and Data Rate must be set identical for all devices within a network, ref. note on page 16.

¹⁶ Output power of High Power modules must be set similar to the output power of the Low Power modules when mixing High- and Low power modules within a single network, ref. note on page 16.

¹⁷ For channels 1, 6, 7, 12, 14 and 16, the maximum allowable RF-data rate is 19.2 kbit/s, due to limitations in modulation bandwidth at the given sub band-edge.

¹⁸ Channel 13, 17 and 18 are the only channels to be used with 500mW (HP) settings within Europe. For channels 17 and 18, the maximum RF speed is 1.2 kbit/s and maximum output power is +25 dBm, due to limitations in spectrum spread at the 869.4-869.65 MHz band-edges.

¹⁹ 76.8 kbit/s is maximum RF bitrate for HP version. 100 kbit/s setting not available

Article Number	RF Channel ¹⁵	Data Rate ¹⁵	Modulation	Output Power ¹⁵
RC119x(HP)-TM	50 channels: 902+n*0.5 MHz for n = channel [1, 50] default: 4: 904.0 MHz	1: 1.2 kbit/s 2: 4.8 kbit/s 3: 19.0 kbit/s 4: 32.768 kbit/s 5: 76.8 kbit/s 6: 100 kbit/s 7: 250 kbit/s ²⁰ 8: 50kbit/s	2-FSK 2-FSK 2-FSK 2-FSK 2-FSK 2-FSK 4-FSK 2-FSK	RC119x-TM 1: -20 dBm 2: -10 dBm 3: 0 dBm 4: 5 dBm 5: 11 dBm RC119xHP-TM 1: 8 dBm 2: 19 dBm 3: 21 dBm 4: 24 dBm 5: 27 dBm
RC2500-TM RC2500HP-TM ¹⁶	83 channels: 2399.75+n*1 MHz for n = channel [1, 83] default: 4: 2403.75 MHz	1: 1.2 kbit/s 2: 4.8 kbit/s 3: 19.2 kbit/s 4: 32.768 kbit/s 5: 76.8 kbit/s 6: 100 kbit/s 7: 250 kbit/s 8: 50kbit/s	GFSK GFSK GFSK GFSK GFSK MSK GFSK	RC2500-TM 1: -20 dBm 2: -10 dBm 3: -5 dBm 4: -1 dBm 5: 1 dBm RC2500HP-TM 1: -10 dBm 2: 0 dBm 3: 5 dBm 4: 10 dBm 5: 17 dBm

²⁰ Available from firmware release 1.45

Article Number	RF Channel ²¹	Data Rate	Modulation	Output Power
RC1701(HP)-TM	13 channels: 1: 169.406250 MHz 2: 169.418750 MHz 3: 169.431250 MHz 4: 169.443750 MHz 5: 169.456250 MHz 6: 169.468750 MHz 7: 169.412500 MHz 8: 169.437500 MHz 9: 169.462500 MHz 10: 169.437500 MHz 11: 160.600000 MHz 12: 160.350000 MHz 13: 160.100000 MHz	1: TBD 2: 0.3 kbit/s 3: 0.6 kbit/s 4: 1.2 kbit/s 5: 2.4 kbit/s 6: TBD 7: 4.8 kbit/s 8: 9.6 kbit/s 9: 9.6 kbit/s 10: 19.2 kbit/s 11: TBD 12: 38.4 kbit/s 13: 50 kbit/s 14: 76.8 kbit/s 15: 100 kbit/s	2-GFSK 2-GFSK 2-GFSK 2-GFSK 2-GFSK 2-GFSK 4-GFSK 2-GFSK 4-GFSK 2-GFSK 2-GFSK 2-GFSK 2-GFSK 2-GFSK	RC1701-TM 1: -40 dBm 2: 2 dBm 3: 6 dBm 4: 10 dBm 5: 14 dBm RC1701HP-TM 1: 14 dBm 2: 17 dBm 3: 20 dBm 4: 24 dBm 5: 27 dBm
RC1740(HP)-TM	173 Channels: 1: 433.0775 Channels: 1-69: 433.0525 + n * 0.025 MHz for n = channel [1, 69] 70: 429.4500 Channels: 71-82: 437.925 + n * 0.025 MHz for n =channel [71, 82] 83: 444.000000 MHz 84: 444.050000 MHz 85: 444.400000 MHz 86: 444.450000 MHz 87: 444.550000 MHz 88: 444.675000 MHz 89: 444.700000 MHz 90: 444.250000 MHz 91: 433.950000MHz 92: 434.000000 MHz 93: 434.050000 MHz Channels: 94-152 446.0875 + n * 0.0125 MHz for n = channel [94, 152] Channels: 153-173 422.7875 + n * 0.0125 MHz for n = channel [153, 173]	1: TBD 2: 0.3 kbit/s 3: 0.6 kbit/s 4: 1.2 kbit/s 5: 2.4 kbit/s 6: TBD 7: 4.8 kbit/s 8: 9.6 kbit/s 9: 9.6 kbit/s 10: 19.2 kbit/s 11: TBD 12: 38.4 kbit/s 13: 50 kbit/s 14: 76.8 kbit/s 15: 100 kbit/s	2-GFSK 2-GFSK 2-GFSK 2-GFSK 2-GFSK 2-GFSK 4-GFSK 2-GFSK 2-GFSK 2-GFSK 2-GFSK 2-GFSK 2-GFSK 2-GFSK	RC1740-TM 1: -40 dBm 2: 2 dBm 3: 6 dBm 4: 10 dBm 5: 14 dBm RC1740HP-TM 1: 14 dBm 2: 17 dBm 3: 20 dBm 4: 24 dBm 5: 27 dBm

²¹ RF Channel, Output Power and Data Rate must be set identical for all devices within a network.

Article Number	RF Channel ²¹	Data Rate	Modulation	Output Power
RC1760(HP)-TM	239 Channels: 1: 458.512500 MHz 2: 458.525000 MHz 3: 458.537500 MHz 4: 458.550000 MHz Channels 5-39: 458.550000 + n * 0.0125 MHz for n = channel [5, 39] Channels 40-119: 457.000000 + n * 0.0125 MHz for n = channel [40, 119] Channels 120-230: 461.500000 + n * 0.0125 MHz for n = channel [120, 230] Channels 231-239: 464.612500 + n * 0.0125 MHz for n = channel [231, 239]	1: TBD 2: 0.3 kbit/s 3: 0.6 kbit/s 4: 1.2 kbit/s 5: 2.4 kbit/s 6: TBD 7: 4.8 kbit/s 8: 9.6 kbit/s 9: 9.6 kbit/s 10: 19.2 kbit/s 11: TBD 12: 38.4 kbit/s 13: 50 kbit/s 14: 76.8 kbit/s 15: 100 kbit/s	2-GFSK 2-GFSK 2-GFSK 2-GFSK 2-GFSK 2-GFSK 4-GFSK 2-GFSK 4-GFSK 2-GFSK 2-GFSK 2-GFSK 2-GFSK 2-GFSK	RC 1760-TM²² 1: -40 dBm 2: 2 dBm 3: 6 dBm 4: 10 dBm 5: 14 dBm RC1760HP-TM 1: 14 dBm 2: 17 dBm 3: 20 dBm 4: 24 dBm 5: 27 dBm
RC1780(HP)-TM	94 Channels: 1: 868.012500 MHz 2: 868.037500 MHz 3: 868.062500 MHz 4: 868.087500 MHz 61: 869.512500 MHz, default channel HP-version Channels 5-80: 867.987500 + n * 0.0250 MHz for n = channel [5, 80] 81: 870.075000 MHz 82: 870.550000 MHz 83: 870.600000 MHz 84: 870.650000 MHz Channels 85-94: 848.100000 + n * 0.2000 MHz for n = channel [85, 94]	1: TBD 2: 0.3 kbit/s 3: 0.6 kbit/s 4: 1.2 kbit/s 5: 2.4 kbit/s 6: TBD 7: 4.8 kbit/s 8: 9.6 kbit/s 9: 9.6 kbit/s 10: 19.2 kbit/s 11: TBD 12: 38.4 kbit/s 13: 50 kbit/s 14: 76.8 kbit/s 15: 100 kbit/s	2-GFSK 2-GFSK 2-GFSK 2-GFSK 2-GFSK 2-GFSK 4-GFSK 2-GFSK 4-GFSK 2-GFSK 2-GFSK 2-GFSK 2-GFSK	RC1780-TM²² 1: -40 dBm 2: 2 dBm 3: 6 dBm 4: 10 dBm 5: 14 dBm RC1780HP-TM 1: 14 dBm 2: 17 dBm 3: 20 dBm 4: 24 dBm 5: 27 dBm

RF channel, output power level and data rate may be changed in configuration memory by using the WRITE CONFIGURATION MEMORY in CONFIGURATION MODE, or by using the SET CONFIGURATION COMMAND for system deployment, while the SYSTEM_ID is set at the factory default 0 0 0 1 value. The default factory settings are shown in **bold** in the table above.

For more details on changing the RF channel, output power or data rate, refer to the description of the CONFIGURATION COMMANDS.

²² Available on request, MOQ applies

The use of RF frequencies, maximum allowed RF power and duty-cycles are limited by national regulations. The RC118x(HP)-TM, RC114x-TM and RC1740/80(HP)-TM are complying with the applicable directives within the European Union when used within these limitations.

RC118x-TM, channels 5-9 are license free channels within Russia.

RC119x-TM is pending approval under FCC for use in the US and Canada. For more information see section REGULATORY COMPLIANCE INFORMATION.

Module Configuration

Module configuration settings may be changed in-circuit from a host MCU during operation, at the time of installation of the equipment, at the manufacturing test, or as wireless configuration commands issued by the Gateway device in a live mesh network.

Configuration Commands

Tinymesh™ modules may be configured during normal operation in an operating mesh network, by using the SET CONFIGURATION COMMAND. Routers as well as Gateway Devices may be configured using this method.

RF CHANNEL, RF DATA RATE, UNIQUE_ID and SYSTEM_ID may be changed by the SET CONFIGURATION COMMAND while the SYSTEM_ID is set to the factory default value (0 0 0 1).

After the SYSTEM_ID has been changed to a value different from the default setting, the above parameters will be locked for configuration, to avoid losing contact with an operating module in a live network.

It is possible to override the configuration locking¹¹ by setting the CONFIGURATION LOCK OVERRIDE = 1.

After setting the desired parameters, it is advisable to reset the CONFIGURATION LOCK OVERRIDE parameter to its default setting = 0.

Gateway Devices in PACKET MODE OPERATION may be forced to enter CONFIGURATION MODE by issuing a SET GATEWAY IN CONFIG MODE command over the UART, as an alternate means to asserting the CONFIG input low.

Configuration Mode

Tinymesh™ modules will enter Configuration Mode by pulling the CONFIG pin low, for direct UART configuration of the module. The Configuration Mode allows a local MCU full control for reconfiguration on the fly, and is highly useful for system development and test. In Configuration Mode, the module will signal response to commands by sending a '>' prompt on the TXD pin. The prompt indicates that the module is ready to receive new commands.

The CONFIG pin may then be de-asserted.

Note that the CONFIG pin must be de-asserted *before* the Exit command ('X') is sent to the module, in order to return to normal operation.

After a command has been executed, the module responds with the '>' prompt character, indicating it is ready for a new command. New commands must not be entered before the '>' prompt has been received.

The time required to execute a command may vary depending on the command (see MEMORY CONFIGURATION TIMING). There is no '>' prompt after the 'X' exit command.

Function	Code ASCII (Hex)	Argument	Response	Note
Get Analogue Port Values ¹³	'A'	No Argument.	Four bytes GPIO 0 and GPIO 1 Analogue Port Input value	GPIO (0,1) must be set as analogue Inputs
Get Digital Port Values ¹³	'D'	No Argument.	Single byte digital port input value	GPIO(0_7) must be set as inputs
Get RSSI	'S' (0x53)	No Argument.	Single byte RF signal strength	See RSSI Reading (S-Command)
Get Temperature	'U' (0x55)	No Argument.	Single byte device temperature.	See TEMPERATURE READING (U-COMMAND)
Get Voltage	'V' (0x56)	No Argument.	Single byte device supply voltage.	See POWER SUPPLY VOLTAGE READING (V- COMMAND)
Read Configuration Memory	'Y' (0x59)	Address 0x00 - 0x7F	Single byte configuration memory value.	Return single byte value from the configuration memory.

Function	Code ASCII (Hex)	Argument	Response	Note
Write Configuration Memory	'M' (0x4D)	Pairs of address and data bytes.	No Response	See SET CONFIGURATION MEMORY (M- COMMAND)
Reset Memory	'@TM' (0x40 0x54 0x4D)	No argument	No Response	Restores configuration memory to factory default values.
Exit Configuration Mode	'X' (0x58)	No argument	No Response	Exit to normal operation mode. All parameter changes take effect.
Set Router Mode	'R' (0x52)	No argument	No Response	Set DEVICE TYPE =2, Set HIAM TIME, CONNECT CHECK TIME, and INDICATORS ON = configured values.
Set Gateway Mode	'G' (0x47)	No argument	No Response	Set DEVICE TYPE =1, Set HIAM TIME and INDICATORS ON = configured values.
Set End Device Mode	'N' (0x4E)	No argument	No Response	Set DEVICE TYPE = 3, Set CONNECT CHECK TIME, IMA TIME and INDICATORS ON= configured values.
Set Sleep Mode	'Z' (0x5A)	No argument	No Response	See SET SLEEP MODE (Z-COMMAND)
Alternate Set Sleep Mode	'z' (0x7A)	No argument	No Response	See ALTERNATE SET SLEEP MODE (z-Command) ¹¹
Set AES Key	'K' (0x4B)	Key index '7' (0x37), 16 bytes key data.	No Response	See SETTING AND CHANGING THE AES KEY (K7- COMMAND)
Write Calibration Memory	'HW' (0x48 0x57)	Pairs of address and data bytes.	No Response	See CHANGE CALIBRATION MEMORY COMMAND (HW-COMMAND)
List Calibration Memory	'r' (0x72)	No argument	Calibration Memory Contents	
List Configuration Memory	'0' (0x30)	No argument	Configuration memory contents	
Test Mode 1	'1' (0x31)	No argument	No Response	TX carrier ON
Test Mode 2	'2' (0x32)	No argument	No argument	TX modulated signal
Test Mode 3	'3' (0x33)	No argument	No Response	RX mode
RSSI Sniffer	'5' (0x35)	Any input will exit and return to RX mode	Single byte RSSI for any valid Tinymesh™ packet received.	See RSSI SNIFFER (TEST MODE 5)
Simple Packet Sniffer	'6' (0x36)	Any input will exit and return to RX mode	RSSI and key packet details for any valid Tinymesh™ packet received.	See SIMPLE PACKET SNIFFER (TEST MODE 6)

Note: ASCII characters are written as 'X', hexadecimal numbers are written like 0x00, and decimal numbers are written like 10 throughout the text. A table of ASCII characters and their respective hex and decimal values may be found in APPENDIX: ASCII TABLE

Commands must be sent as ASCII characters or their corresponding binary value. All arguments must be sent as binary values to the module (not as ASCII representation for hex or decimal). Any invalid command will be ignored and the '>' prompt will be re-sent. The CONFIG input must be de-asserted after the first '>' prompt was received, but before the 'X' command.

RSSI Reading (S- Command)

The module provides a digital Received Signal Strength Indicator (RSSI) through the 'S' command when in Configuration Mode and included in received messages when the Gateway Device is operating in Packet Mode. The module returns an 8-bit character (one byte) indicating the current input signal strength (followed immediately by a second character which is the prompt ('>') when in command mode). The signal strength is used by the TinyMesh™ protocol to indicate fading margin, and as a carrier sense signal to avoid collisions.

The signal strength measured by the S command is the instantaneous value. The ORIGIN RSSI value included in the header portion of all received packets, is the signal strength at the originating module, when receiving data from the module that has been selected as the first receiver of packets from the originating module i.e. the first jump in the mesh network.

The RSSI value increases with increased input signal strength in 0.5 dB steps. Input signal strength is given by (typ):

$$P = - \text{RSSI} / 2 \text{ [dBm]}$$

The dynamic range of the RSSI (P) goes from the Sensitivity level up to typical -30 dBm (RSSI saturation level).

Temperature Reading (U- Command)

The module provides readings of a digital temperature-monitoring sensor (TEMP) through the 'U' command. The module returns an 8-bit character (one byte) indicating the current temperature in degrees Celsius (°C) followed immediately by a second character which is the prompt ('>').

The TEMP value is also returned in all GENERAL EVENT PACKET FORMAT packets while the module is operating in Packet mode

The TEMP value increases with increased temperature in 1 °C steps and accuracy of +/- 2 °C. Temperature is given by:

$$T = \text{TEMP}(\text{dec}) - 128 \text{ [°C]} \text{ (Example: TEMP=0x98 equals +24 °C)}$$

Power Supply Voltage Reading (V- Command)

The module provides readings of an internal power supply voltage-monitoring sensor (VCC) through the 'V' command. The module returns an 8-bit character (single byte) indicating the current power supply voltage level, followed immediately by a second character which is the prompt ('>'). The command can be useful for battery voltage level monitoring.

The VCC value is also returned in all GENERAL EVENT PACKET FORMAT packets while the module is operating in Packet mode

The VCC value increases with increased power supply voltage in 30 mV steps. The power supply voltage is given by:

$$V = \text{VCC}(\text{dec}) * 0.030 \text{ [V]} \text{ (Example: VCC=0x68 equals 3.12 [V])}$$

Set Configuration Memory (M- Command)

Configuration parameters in non-volatile CONFIGURATION MEMORY may be changed using the 'M' command

Example: To select Channel 3, change contents of memory address 0x00 to new value 0x03.

Command	Hex	Response	Comment
Enter Configuration Mode		'>'	By Asserting and releasing the CONFIG input, or By issuing the SET GATEWAY IN CONFIG MODE command to a Gateway Device
'M'	0x4D	'>'	Wait for '>' prompt
0	0x00	No response	Address byte received, waiting for Data byte
3	0x03	No response	Data byte received, module waiting for next address or 255 (0xFF) to terminate Memory Configuration
255	0xFF	'>'	Wait t _{MEMORY-CONFIG} for '>' prompt
New command			The Module remains in Configuration Mode until 'X' command received
'X'	0x58	No response	The TinyMesh™ protocol runs through a full Power On Reset Cycle, to ensure all configuration changes are applied.

Set Sleep Mode (Z-Command)

The 'Z' command will set a module in temporary low power sleep mode. The module will only accept the 'Z'- command if the CONFIG input pin is low. The module will enter sleep mode immediately on receiving the 'Z'-byte, and will remain in SLEEP mode until the CONFIG Input is driven high, or the module receives an external RESET.

Note: The internal RTS/ SLEEP and CONFIG input pull-up resistors are disabled during sleep mode to reduce excessive power leakage. The CONFIG and SLEEP inputs must therefore be actively driven to the logic high state to exit sleep mode.

Alternate Set Sleep Mode (z-Command)

The 'z' command¹¹ will set a module in temporary low power sleep mode. The module will enter sleep mode immediately on receiving the 'z' byte and will remain in sleep mode until a new start bit (high to low transition) is received on the UART RXD pin. The module will accept the 'z'- command regardless of status of the CONFIG input pin.

Setting and Changing the AES key (K7- Command)

The default AES key 'TinyMeshAESKey#7' has been pre-loaded to all modules shipped from factory. Initial testing of encrypted communication may be performed using the default key, but systems should not be deployed until a new, secret 16-byte key has replaced the default key.

AES keys are stored in a dedicated part of flash memory that is not readable by the '0' and 'r' Configuration Mode commands. After entering a new AES key, there is no way for reading the key back. If there is uncertainty as to what key has been entered in a module, the only way to make sure is to reprogram the key. The key storage part of flash is also retained during an '@TM' factory reset of flash memory and may not be changed using the 'M' or 'HW' commands.

The AES Key may only be changed using the 'K' command while the module is in Configuration Mode. The following steps should be used to program a new 16-byte key with value 'A B C D E F G H I J K L M N O P':

Command	Hex	Response	Comment
Enter Configuration Mode		'>'	By Asserting and releasing the CONFIG input, or By issuing the SET GATEWAY IN CONFIG MODE command to a Gateway Device
'K7'	0x4B 0x37	'>'	Wait for '>' prompt

'A B C D E F G H I J K L M N O P'		'>'	<i>Note there is a 10 second maximum time-out between characters</i>
'X'	0x58	No response	The Tinymesh™ protocol runs through a full Power On Reset Cycle, to ensure all configuration changes are applied.

Change Calibration Memory Command (HW- Command)

Configuration parameters in non-volatile CALIBRATION MEMORY may be changed using the WRITE CALIBRATION MEMORY command. See examples below: CALIBRATING THE TEMPERATURE SENSOR, SETTING AND CHANGING THE NETWORK ID (NID) and SETTING AND CHANGING THE FIXED DESTINATION ID (FDID).

Calibrating the Temperature Sensor

The internal temperature sensor may require calibration to show correct value. The TEMP OFFSET parameter in CALIBRATION MEMORY is used for temperature calibration in steps of 0.25 degree Celsius.

To calibrate the temperature sensor, locate the Tinymesh™ module in a temperature-controlled environment, enter CONFIGURATION MODE and make sure the module is given sufficient time to adapt to the environmental temperature.

Read back the current value of the temperature sensor using the GET TEMPERATURE command.

Calculate the actual temperature using the formula in TEMPERATURE READING (U- COMMAND), and find the offset as the difference between actual room temperature and the sensor reading.

Multiply the found difference by 4 and subtract from the TEMP OFFSET, if the sensor is showing too high value, or add to the TEMP OFFSET if the sensor is showing too low temperature.

Verify the sensor calibration by repeat readings using the 'U' command

Example:

To calculate a new temperature offset

Room temperature:

24 [°C]

Module reading (U- command):

0x9A = decimal 154

1) Convert module reading to temperature in °C:

154-128 = 26 [°C]

2) Calculate the temperature error reading:

24 - 26 = -2 [°C]

3) Calculate the compensation offset:

-2 * 4 = -8

4) Calculate the new Temp Offset value:

Temp Offset = TempOffset - 8

If TEMP OFFSET is currently set at the factory default 128, the new TEMP OFFSET will be 120

Command	Hex	Response	Comment
Enter Configuration Mode		'>'	By Asserting and releasing the CONFIG input, or By issuing the SET GATEWAY IN CONFIG MODE command to a Gateway Device
'HW'	0x48 0x57	'>'	Wait for '>' prompt
0	0x00	No response	Address byte received, waiting for Data byte
120	0x03	No response	Data byte received, module waiting for next address, or 255 (0xFF) to terminate Memory Configuration
255	0xFF	'>'	Wait t _{MEMORY-CONFIG} for '>' prompt
New command			The Module remains in Configuration Mode until 'X' command received
'X'	0x58	No response	The Tinymesh™ protocol runs through a full Power On Reset Cycle, to ensure all configuration changes are applied.

Setting and Changing the Network ID (NID)

The Tinymesh™ NETWORK ID is an additional level of network addressing that may be deployed to distinguish between multiple Tinymesh™ networks sharing a common platform or server, such as the Tinymesh™ Cloud service.

The NETWORK ID needs only be entered in the Gateway Device(s) and has no effect on the internal addressing in the individual Tinymesh™ networks. By entering unique NETWORK IDs in the Gateway Devices, different local networks having identical SYSTEM_ID, may still be differentiated on a larger platform, as the NETWORK ID will serve as an additional level of systems identification that provides differentiation between messages originating from different systems with identical SYSTEM_ID.

The NETWORK ID is stored in the Calibration part of Flash memory. This part of flash is retained even after a RESET MEMORY command, and may only be changed using WRITE CALIBRATION MEMORY command from Configuration Mode. The LIST CALIBRATION MEMORY command may be used to read back and verify the contents the CALIBRATION MEMORY. The following steps should be used to program a new NETWORK ID with value 4 3 2 1.

Command	Hex	Response	Comment
Enter Configuration Mode		'>'	By Asserting and releasing the CONFIG input, or By issuing the SET GATEWAY IN CONFIG MODE command to a Gateway Device
'HW'	0x48 0x57	'>'	Wait for '>' prompt
23 1 24 2 25 3 26 4 or Hex: 0x17 0x01 0x18 0x02 0x19 0x03 0x1A 0x04		No response	Four pairs of address and data received, module waiting for next address or 255 (0xFF) to terminate the command
255	0xFF	'>'	Wait t _{MEMORY-CONFIG} for '>' prompt
'r'	0x72	Calibration Memory	Read back the Calibration Memory contents to verify correct settings
'X'	0x58	No response	The Tinymesh™ protocol runs through a full Power On Reset Cycle, to ensure all configuration changes are applied.

Setting and Changing the Fixed Destination ID (FDID)

A Tinymesh™ device may be forced to assume a permanent network connection by setting the FIXED DESTINATION ID to a value different from the default 0:0:0:0 setting. A FIXED DESTINATION ID may be useful in systems using sleeping devices, where the device should spend as little time as possible making a network connection after wakeup.

Note: A device that has been configured with FIXED DESTINATION ID will skip the normal procedure of searching for the best available network connection, and will not support Self-forming, Self-healing and Self-optimizing.

The FIXED DESTINATION ID is stored in the Calibration part of Flash memory. This part of flash is retained even after a RESET MEMORY command, and may only be changed using WRITE CALIBRATION MEMORY command from Configuration Mode. The LIST CALIBRATION MEMORY command may be used to read back and verify the contents the CALIBRATION MEMORY. The following steps should be used to program a new FIXED DESTINATION ID with value 4 3 2 1.

Command	Hex	Response	Comment
Enter Configuration Mode		'>'	By Asserting and releasing the CONFIG input, or By issuing the SET GATEWAY IN CONFIG MODE command to a Gateway Device
'HW'	0x48 0x57	'>'	Wait for '>' prompt
27 1 28 2 29 3 30 4 or Hex: 0x1B 0x01 0x1C 0x02 0x1D 0x03 0x1E 0x04		No response	Four pairs of address and data received, module waiting for next address or 255 (0xFF) to terminate the command
255	0xFF	'>'	Wait t _{MEMORY-CONFIG} for '>' prompt
'r'	0x72	Calibration Memory	Read back the Calibration Memory contents to verify correct settings
'X'	0x58	No response	The Tinymesh™ protocol runs through a full Power On Reset Cycle, to ensure all configuration changes are applied.

RSSI Sniffer (Test Mode 5)

When set to Test Mode 5, the module will output a single byte, received RSSI level for any received and correctly formatted Tinymesh™ packet. Only packets with matching SYSTEM_ID will be accepted by the RSSI Sniffer function.

Simple Packet Sniffer (Test Mode 6)

When set to Test Mode 6, the module will output the received RSSI level for any received and correctly formatted Tinymesh™ packet, followed by a limited set of descriptive data derived from the received packet. Only packets with matching SYSTEM_ID will be accepted by the Sniffer function.

Simple Packet Sniffer Output Format:

|RSSI|Packet Size|Destination ID|Source ID|Origin Jump Level|Packet Type|Message Counter*

*The Sniffer output is 12 or 14 bytes per packet. There is no Message Counter if the received packet is an ACK or a Beacon packet.

Simple Packet Sniffer Format Details:

Byte	Name	Description		
1	RSSI	Signal Strength of packet as received by Sniffer Device		
2	Packet Length	Total length of packet, including header and payload data. Length will vary with Packet Type (see below)		
3-6	Destination ID	Next receiver of this packet. (Final destination is always Gateway Device)		
7-10	Source ID	Last transmitter of this packet. (Not device that created the packet)		
11	Origin Jump Level	Jump level of device that created this packet		
12	Packet Type	Packet Type	Packet Length	Description
		0x02	0x2D	Event Message, ref. Received Packet Formats
			0x95	Response to GET CONFIGURATION MEMORY command

			Variable	Response to GET PACKET PATH and Encrypted packets
		0x03	0x1F	Control and Status Request Command, ref. TRANSMITTING COMMAND AND CONFIGURATION PACKETS FROM GATEWAY
			0x3D	Change Configuration Command, ref. TRANSMITTING COMMAND AND CONFIGURATION PACKETS FROM GATEWAY
		0x04	Variable	Encrypted Command
		0x0A	0x11	Acknowledge (Link level)
		0x0B	0x11	Beacon (Network Invite)
		0x0C	0x11	Beacon from Locator Device, ref. LOCATOR FUNCTION
		0x0E	0x11	Connection Request
		0x10	0x1E to 0x95	Serial data to Gateway, ref. RECEIVED PACKET FORMATS
		0x11	0x1E to 0x95	Serial data from Gateway, ref. TRANSMIT SERIAL DATA PACKET FROM GATEWAY
		0xFF		Unknown Packet Type
13	Message Counter	Sequential counter maintained by originating device. Not applicable for 0x0A,0x0B,0x0C and 0x0E packets		

Note: While processing serial port output data, the module may not be able to receive new RF data packets.

To avoid losing data, the transfer speed should be set to the highest acceptable data rate. The Tinymesh™ module will support data rates up to 230 400 by setting the UART BAUD RATE parameter in Configuration Memory.

Configuration Memory

The table below shows the complete list of configurable parameters stored in non-volatile Configuration memory. These values may be changed using the 'M' command while the module is in Configuration Mode (page 52), or through Gateway Commands (page 26). All addresses and arguments must be sent as binary values to the module (not as ASCII representation for hex or decimal).

The FW column indicates first Tinymesh™ firmware release supporting the referenced parameter.

Parameter	Description	Address	Argument	Factory setting	Comment	FW																																																
RF CHANNEL	RF channel	0	RC114x: 1-17 RC117x(HP): 1-15 RC118x(HP): 1-18 RC119x(HP): 1-50 RC2500(HP): 1-83 RC1701(HP): 1-13 RC1740(HP): 1-173 RC1760(HP): 1-239 RC1780(HP): 1-94 Note ²³	RC11xx(HP):4 Except: 118xHP: 13 RC2500(HP): 4 RC1701(HP): 1 RC1740(HP): 1 RC1760(HP): 4 RC1780: 4 RC1780HP: 61	See table RF FREQUENCIES, OUTPUT POWER AND DATA RATES for details. HP (High Power) versions might have reduced number of available channels																																																	
RF POWER	RF output power	1	1-5 ²³	5	See table RF FREQUENCIES, OUTPUT POWER AND DATA RATES for details <i>Power setting must be identical for all devices in a network, Please reference note page 16</i>																																																	
RF DATA RATE	RF data rate	2	RC11xx(HP): 1-6, 8 RC119x(HP): 1-8 RC25xx(HP): 1-6, 8 RC17XX(HP): 1-15 Note ²³	RC11xx(HP): 5 RC25xx(HP): 5 RC17xx(HP):10	See table RF FREQUENCIES, OUTPUT POWER AND DATA RATES for details																																																	
Protocol Mode	Packet format selection	3	Transparent:1 ²⁴ Packet: 0	1	See TRANSPARENT- VERSUS PACKET- MODE OPERATION																																																	
RSSI Acceptance level	Minimum RSSI to accept network connection	4	160- 210, 255 ²⁵	255 ^{25,29}	Auto Selected RSSI Acceptance levels for given RF DATA RATES: RC17XX(HP)-TM <table border="1"> <tr><td>2</td><td>3</td><td>4</td><td>5</td><td>7</td><td>8</td><td>9</td><td>10</td><td>12</td><td>13</td><td>14</td><td>15</td></tr> <tr><td>230</td><td>230</td><td>230</td><td>226</td><td>220</td><td>214</td><td>208</td><td>208</td><td>205</td><td>203</td><td>202</td><td>202</td></tr> </table> RC11xx(HP)-TM, RC2500(HP)-TM: Revised values in 2 nd row ^{26,27} <table border="1"> <tr><td>1</td><td>2</td><td>3</td><td>4</td><td>5</td><td>6</td><td>7</td><td>8</td></tr> <tr><td>214</td><td>208</td><td>202</td><td>196</td><td>190</td><td>188</td><td>184</td><td>192</td></tr> <tr><td>208</td><td>200</td><td>196</td><td>190</td><td>186</td><td>182</td><td>178</td><td>188</td></tr> </table>	2	3	4	5	7	8	9	10	12	13	14	15	230	230	230	226	220	214	208	208	205	203	202	202	1	2	3	4	5	6	7	8	214	208	202	196	190	188	184	192	208	200	196	190	186	182	178	188	
2	3	4	5	7	8	9	10	12	13	14	15																																											
230	230	230	226	220	214	208	208	205	203	202	202																																											
1	2	3	4	5	6	7	8																																															
214	208	202	196	190	188	184	192																																															
208	200	196	190	186	182	178	188																																															
RSSI Clear Channel Assessment level	Max RSSI for Clear Channel during Listen Before Talk	5	100- 210	140 ²⁸	<i>Do not change</i>																																																	
HIAM Time	Time in seconds between network invites	6	RC17xx(HP)-TM 1-63, 255 RC11xx(HP)-TM RC2500(HP)-TM 1-8	Note: ²⁹ Router, G'way:255 ²⁵ End Dev: 1 Router, End Dev and Gateway:1 ²⁶	Auto selected HIAM Time at given RF DATA RATES RC17xx(HP): <table border="1"> <tr><td>2</td><td>3</td><td>4</td><td>5</td><td>7</td><td>8</td><td>9</td><td>10</td><td>12</td><td>13</td><td>14</td><td>15</td></tr> <tr><td>26</td><td>18</td><td>12</td><td>8</td><td>5</td><td>4</td><td>3</td><td>3</td><td>2</td><td>1</td><td>1</td><td>1</td></tr> </table> Recommended HIAM Time(s), at given RF DATA RATES RC11xx(HP)-TM, RC2500(HP)-TM: <table border="1"> <tr><td>1</td><td>2</td><td>3</td><td>4</td><td>5</td><td>6</td><td>7</td><td>8</td></tr> <tr><td>6</td><td>5</td><td>4</td><td>3</td><td>1</td><td>1</td><td>1</td><td>1</td></tr> </table>	2	3	4	5	7	8	9	10	12	13	14	15	26	18	12	8	5	4	3	3	2	1	1	1	1	2	3	4	5	6	7	8	6	5	4	3	1	1	1	1									
2	3	4	5	7	8	9	10	12	13	14	15																																											
26	18	12	8	5	4	3	3	2	1	1	1																																											
1	2	3	4	5	6	7	8																																															
6	5	4	3	1	1	1	1																																															
IMA Time	Time in minutes between automatic status messages	7	1-255 255= never	Router and G-way: 255 End Dev.: 10	Note ²⁹																																																	
Connect Check Time	Time in seconds between network evaluation	8	RC17xx(HP)-TM 1-20, 255 ²⁵ RC11xx(HP)-TM RC2500(HP)-TM 1-254,255	Note: ²⁹ Router, End Dv.:255 ²⁵ Gateway: 6 255 ²⁶	RC17xx(HP): Auto selected Connect Check Time at given RF DATA RATE s <table border="1"> <tr><td>2</td><td>3</td><td>4</td><td>5</td><td>7</td><td>8</td><td>9</td><td>10</td><td>12</td><td>13</td><td>14</td><td>15</td></tr> <tr><td>104</td><td>72</td><td>48</td><td>32</td><td>20</td><td>16</td><td>12</td><td>12</td><td>8</td><td>4</td><td>4</td><td>4</td></tr> </table> RC11xx(HP)-TM, RC2500(HP)-TM: Recommended Connect Check Time(s), at given RF DATA RATE <table border="1"> <tr><td>1</td><td>2</td><td>3</td><td>4</td><td>5</td><td>6</td><td>7</td><td>8</td></tr> <tr><td>24</td><td>20</td><td>16</td><td>12</td><td>4</td><td>4</td><td>4</td><td>4</td></tr> </table>	2	3	4	5	7	8	9	10	12	13	14	15	104	72	48	32	20	16	12	12	8	4	4	4	1	2	3	4	5	6	7	8	24	20	16	12	4	4	4	4									
2	3	4	5	7	8	9	10	12	13	14	15																																											
104	72	48	32	20	16	12	12	8	4	4	4																																											
1	2	3	4	5	6	7	8																																															
24	20	16	12	4	4	4	4																																															

²³ Configuration commands attempting to set values out of range will not be accepted

²⁴ Values greater than '1' treated as '1'

²⁵ Default value 0 or 255 provides auto setting per configured RF DATA RATE from FW 1.44

²⁶ Default value 255 provides auto select from FW version 1.47

²⁷ Revised values recommended for improved mesh stability also for prior releases.

²⁸ Changed to 140 from FW version 1.44

²⁹ Set by 'G', 'R', 'N'-command in Configuration Mode

Parameter	Description	Address	Argument	Factory setting	Comment	FW
Max Jump Level	Highest allowable network jump level (hop level)	9	1-255 ³⁰	20		
Max Jump Count	Maximum number of transportation jumps (hops) before a packet is eliminated, assumed undeliverable.	10	1-255 ³⁰	30		
Max Packet Latency	Maximum transport time before a packet is eliminated, assumed undeliverable.	11	1-255 ³⁰	5 (5*256*10ms =12.8 sec)	10ms to 652.8 s. Calculated from a time base of either 10 ms or 256*10ms, as selected by MAX PACKET LATENCY TIME BASE	
RF Transmit Retry Limit	Number of unsuccessful RF retries before a Router Device disconnects and attempts re-connection to the network.	12	1-255 ³⁰	25 100 ³¹		
Serial Port Time Out	Time out in periods of 1ms between character inputs on serial port, before a packet is transmitted in Transparent mode.	13	1-255 ³²	20	An additional 2ms is automatically added. Actual timing for setting 20 is 22 ms	
Device Type	Selection sets the device operating mode, as Gateway, Router or End Device.	14	1-3 ³³	2	1 = Gateway Device 2 = Router Device 3 = End Device <i>Set by 'G', 'R', 'N' commands in Configuration Mode</i>	1.40 ³⁴
Excellent RSSI Level		15	0-255	150	Do not Change	1.37
GPIO 0 Configuration	Configure GPIO 0/ Module Pin 15	16	0,1,2,4 ³⁵	1	0 = Output, default High 1 = Input 2 = Analogue in 4 = Output, default Low	
GPIO 1 Configuration	Configure GPIO 1/ Module Pin 16	17	0,1,2,4 ³⁵	1	0 = Output, default High 1 = Input 2 = Analogue in 4 = Output, default Low	
GPIO 2 Configuration	Configure GPIO 2/ Module Pin 20	18	0,1,4 ³⁵	1	0 =Output, default High 1 = Input 4 = Output, default Low	
GPIO 3 Configuration	Configure GPIO 3/ Module Pin 22	19	0,1,4 ³⁵	1	0 = Output, default High 1 = Input 4 = Output, default Low	
GPIO 4 Configuration	Configure GPIO 4/ Module Pin 26	20	0,1,4 ³⁵	1	0 = Output, default High 1 = Input 4 = Output, default Low	
GPIO 5 Configuration	Configure GPIO 5/ Module Pin 25	21	0,1,4 ³⁵	1	0 = Output, default High 1 = Input 4 = Output, default Low	
GPIO 6 Configuration	Configure GPIO 6/ Module Pin 24	22	0,1,4 ³⁵	1	0 = Output, default High 1 = Input 4 = Output, default Low	
GPIO 7 Configuration	Configure GPIO 7/ Module Pin 23	23	0,1,3,4 ³⁵	1	0 = Output, default High 1 = Input 3 = PWM output 4 = Output, default Low	
GPIO 0 trig	Trigger an event on input level change if port set as input	24	0-3 ³⁶	0	0 = No trig 1 = Rising edge 2 = Falling edge 3 = Both edges	

³⁰ Zero value treated as 1

³¹ Tx Retry default increased to 100 from FW version 1.47

³² After adding 2, values 254 and 255 will be interpreted as 255

³³ Values different from 1 or 3 will be treated as 2 (Router)

³⁴ Applies to End Device selection

³⁵ Values out of range will be treated as 1 (Input)

³⁶ Values out of range will be treated as 0 (No Trig)

Parameter	Description	Address	Argument	Factory setting	Comment	FW
GPIO 1 trig	Trigger an event on input level change if port set as input	25	0-3 ³⁶	0	0 = No trig 1 = Rising edge 2 = Falling edge 3 = Both edges	
GPIO 2 trig	Trigger an event on input level change if port set as input	26	0-3 ³⁶	0	0 = No trig 1 = Rising edge 2 = Falling edge 3 = Both edges	
GPIO 3 trig	Trigger an event on input level change if port set as input	27	0-3 ³⁶	0	0 = No trig 1 = Rising edge 2 = Falling edge 3 = Both edges	
GPIO 4 trig	Trigger an event on input level change if port set as input	28	0-3 ³⁶	0	0 = No trig 1 = Rising edge 2 = Falling edge 3 = Both edges	
GPIO 5 trig	Trigger an event on input level change if port set as input	29	0-3 ³⁶	0	0 = No trig 1 = Rising edge 2 = Falling edge 3 = Both edges	
GPIO 6 trig	Trigger an event on input level change if port set as input	30	0-3 ³⁶	0	0 = No trig 1 = Rising edge 2 = Falling edge 3 = Both edges	
GPIO 7 trig	Trigger an event on input level change if port set as input	31	0-3 ³⁶	0	0 = No trig 1 = Rising edge 2 = Falling edge 3 = Both edges	
Input De-bounce	De-bounce time in ms for all inputs	32	0-255	10		
GPIO 0 Analogue High trig High byte	High byte of two byte High Trig level value	33	0-7	7		
GPIO 0 Analogue High Trig Low byte	Low byte of two byte High Trig level value	34	0-255	255		
GPIO 0 Analogue Low Trig High byte	High byte of two byte Low Trig level value	35	0-7	0		
GPIO 0 Analogue Low Trig Low byte	Low byte of two byte Low Trig level value	36	0-255	0		
GPIO 0 Analogue Sampling Interval	Time between samplings in 10ms increments	37	0-255	100 ³⁷		
GPIO 1 Analogue High trig High byte	High byte of two byte High Trig level value	38	0-7	7		
GPIO 1 Analogue High trig Low byte	Low byte of two byte High Trig level value	39	0-255	255		
GPIO 1 Analogue Low trig High byte	High byte of two byte Low Trig level value	40	0-7	0		
GPIO 1 Analogue Low trig Low byte	Low byte of two byte Low Trig level value	41	0-255	0		
GPIO 1 Analogue Sampling Interval	Time between samplings in 10ms increments	42	0-255	100		
CTS hold time	CTS hold time in 10ms increments	43	1-255 ³⁰	6 (60ms)	Active on Gateway only.	
Locator_Enable	Enable locator function	44	0 or 1	0		
UNIQUE_ID0 (UID0)		45	0-255	Unique	UID= UID3:UID2:UID1:UID0 UID 0 0 0 0 is not allowed	
UNIQUE_ID1 (UID1)		46	0-255	Unique		
UNIQUE_ID2 (UID2)		47	0-255	Unique		
UNIQUE_ID3 (UID3)		48	0-255	Unique		
SYSTEM_ID0 (SID0)		49	0-255	1	SID= SID3:SID2:SID1:SID0 SID 0 0 0 0 is not allowed	
SYSTEM_ID1 (SID1)		50	0-255	0		
SYSTEM_ID2 (SID2)		51	0-255	0		
SYSTEM_ID3 (SID3)		52	0-255	0		
Data and configuration interface, UART Serial Port						

³⁷ Analogue Sampling Increments changed from 100ms to 10ms from FW 1.40

Parameter	Description	Address	Argument	Factory setting	Comment	FW
UART Baud Rate	Baud rate	53	1: 2 400 2: 4 800 3: 9 600 4: 14 400 5: 19 200 6: 28 800 7: 38 400 8: 56 700 9: 76 800 10: 115 200 11: 230 400	5	<i>BE CAREFUL WHEN CHANGING, AS HOST MAY LOOSE CONTACT WITH MODULE!</i>	
UART Bits		54	8 or 9 ³⁸	8	9-bit word enables parity	1.47
UART Parity		55	0 or 1 ³⁹	0	0= Even / 1= Odd parity	1.47
UART Stop Bits		56	1 or 2 ⁴⁰	1	Number of stop bits	1.21
Reserved		57			Do not change	
UART Flow Control	Select handshake ⁴¹ : CTS (1) RTS (2) RXTX (4) Xon/Xoff (8) ACK/ NAK (16) Wait For ACK (32) CRC Append (64)	58	01-59	1 (0x01)= CTS enabled	Reference SERIAL PORT HANDSHAKE Add setting values to combine modes: RTS+CTS = 1+2=3 CTS should always be active, except in mode 4 (RXTX)	1.31
Serial Buffer Full Margin		59	0-100	18	Number of bytes left in Serial Buffer when CTS goes false and /or Xoff transmitted	1.31
Module description						
PART Number		60- 68 or 60- 70		RCxxxx-TM or RCxxxxHP-TM	Not Configurable	
Fill Byte		69 or 71		44 (,)	Delimiter byte between Part Number and Hardware Revision	
HW Revision		70- 73 or 72- 75		x.yz	x, y and z; Any number 0-9 decimal Not Configurable	
Fill Byte		74 or 76		44 (,)	Delimiter byte between Hardware- and Software Revision	
FW Revision		75- 78 or 77- 80		x.yz	x, y and z; Any number 0-9 decimal Not Configurable	
Miscellaneous settings						
Security Level	Selected encryption mode	81	0-2 ⁴² 0: Off 1: On 2: Compatible	0	Selected Security Level. Mode 2 will reduce packet size to be compatible with unencrypted systems	1.31
Reserved		82, 83				
Max Packet Latency Time Base	Time Base for MAX PACKET LATENCY calculation.	84	0 / 1	1	0=10ms time resolution 1= 2560ms time resolution	1.40
IMA time base	Time Base for IMA Timer and End Device wake-up, in periods of 10 seconds	85	1-255	6	Default setting of 6 sets IMA timer to 1 minute resolution	1.40
End Device Wait for Command	End Device, periods of 0.1 seconds to wait for command before returning to sleep	86	0-255	10	Default setting of 10 sets wait time to 1 second.	1.40

³⁸ Value different from 9 will be treated as 8

³⁹ Value different from 1 will be treated as zero (no parity)

⁴⁰ Value different from 2 will be treated as 1 (Single stop bit)

⁴¹ RTS, Xon/ Xoff, ACK/NAK, Wait For ACK from FW 1.31. RXTX from FW 1.40

⁴² Unrecognised values will be treated as 1 (Encrypted)

Parameter	Description	Address	Argument	Factory setting	Comment	FW
End Device Wakeup Enable	Bitmap of signals that are allowed to wake End Device	87	0-143	8 (Bit 0 : 0 Bit 1 : 0 Bit 2 : 0 Bit 3 : 1)	Bit-map of signals that may wake End Device Bit 0 (bit value 1):Pulse Counter Bit 1 (bit value 2): GPIO Bit 2 (bit value 4): Serial Port Bit 3 (bit value 8): IMA Timer Bit 7 (bit value 128): Enable wait for Locator Beacon Add bit values to set desired combination. Example: Select 8+2 = 10 for IMA timer+ GPIO	1.40
Configuration Mode Entry Control	Additional security for entering Configuration Mode	88	0: No Security 1: Time Out 2: Two Step Entry 3: Time Out + Two Step Entry	0	Provides additional security against undesired entry in Configuration Mode	1.47
Indicators On	Time-out in minutes for Connect, RSSI and Feedback indicators	89	0-255 0: Always Off 255: Always On	Router and G-way: 255 End Device: 1	Should be set to 1 or low value for End Devices, to minimize power consumption ²⁹	1.40
Receive Neighbour Messages	Accept messages from direct neighbour nodes for serial port output	90	0/1 0: Off 1: On	0		1.40
Command Acknowledge	Enable command acknowledge from destination device	91	0/1 0: Off 1: On	1	Applicable in packet mode only. Not applicable for Gateway Device	1.20
Reserved		92				
Sleep or RTS	Set function for RTS / SLEEP pin	93	0/1 0: RTS 1: Sleep	0		1.40
IMA On Connect	Enable automatic IMA message on Network connection	94	0/1 ⁴³ 0: Off 1: On	0	See IMA ON CONNECT FUNCTION for details	
PWM Default	Default PWM duty-cycle at Reset	95	0-100 ⁴⁴	0	See PWM (DIMMER) OUTPUT for details	
Pulse Counter Mode	Enables the pulse counter function	96	0: Off 1: On,W/ Pull Up 3: On,W/O Pull Up	0	Bit map of selections Bit 0 (bit val. 1): PC On / Off Bit 1 (bit val. 2): Pull Up Disable Bit 2 (bit val. 4): TBA	1.40
Pulse Counter Debounce	De-bounce time in ms for Pulse counter	97	0-255	0 = no de-bounce		1.40
Connection Change Margin	Minimum difference in RSSI to justify automatic change of network connection	98	0-255	18	Changed from 12 to 18 in FW release 1.51	1.51
Clustered Node Device Limit	Minimum number of densely located nodes required to be defined as a cluster	99	5-100	10	Closely located nodes are forced to act as a single node by reducing network Beacon (HIAM) activity	1.34
Clustered Node RSSI	RSSI level to form a node cluster	100	40-100	60		1.34
Detect Network Busy	Gateway action when network activity detected after Reset.	101	0-2 ⁴⁵ 0: Ignore 1: Halt+Warn 2: Warn	0	Applicable in Packet mode only	1.20
RF Jamming Detect	RF Jamming Detection Time	102	0-100	0 = Off	Minimum time in minutes of continuous radio jamming on all radio channels before an RF Jamming alarm is generated	1.34
RF Jamming Alarm Port	GPIO port used for RF Jamming alarm output	103	0-7, 255 0-7:Selected port 255: Disabled ⁴⁶	255	The selected GPIO will go LOW on alarm status, and will remain LOW for as long as alarm status is present. Note: Selected GPIO must be configured for High Output	1.34

⁴³ Value different from 0 will be treated as 1 (on)

⁴⁴ Out of range values will be treated as 0

⁴⁵ Value larger than 2 will be treated as 2

Parameter	Description	Address	Argument	Factory setting	Comment	FW
Feedback Port	GPIO selection for Pulse Counter Feedback	104	0-7, 255 0-7: Selected port 255: Disabled ⁴⁶	255	Port configuration must be set for Output	1.40
Feedback Enable	Select event types that will generate feedback flash	105	0,2 0: No Feedback 2: Pulse Count	0		1.40
IMA Message Data Field Contents	Selects contents of Message Data field in IMA Message	106	0-6 0: No data 1: GPIO Trig-hold 2: Pulse Counter 5: My Connects ¹¹ 6: MyLocatorRSSI	0		1.40
IMA Message Address Field Contents	Selects contents of Address Data field in IMA Message	107	0- 0: No Data 1: Pulse Counter 2: Locator ID 3: Destination ID 4: Alternate Destination ID ¹¹	2		1.40
Trig Hold	Bitmap of triggered GPIO inputs that will be reported next IMA period	108	0-255	0	1: GPIO 0 16: GPIO 4 2: GPIO 1 32: GPIO 5 4: GPIO 2 64: GPIO 6 8: GPIO 3 128:GPIO7 Add values for multiple ports Example: 7= GPIO 0+1+2 Port must be enabled for event trig	1.40
End Device Awake Port	Selects GPIO to signal Awake condition for End Device	109	0-7, 255 0-7: Selected Port 255: Disabled	255		1.40
Configuration Lock Override	Enables configuration of locked parameters when SID not 0 0 0 1	110	0: Locked 1: Lock Override	0		1.43
Reserved		111-112				
Group Table	Group IDs that this node belongs to	113-120	0-255	0,0,0,0,0,0,0,0	See Page 26 for Group addressing	1.40
Accept New Command Time Out	Minimum time before new command accepted (10 ms)	121	0-255	10	Do Not Change	
Command Retry	Retries if no response to command transmit	122	0-127	3 4 ⁴⁷	Do not Change Gateway Device uses double setting value.	
MAC RndTime2Mask	Radio State 1 max. delay mask. Repeat TX	123	0x7F, 0x3F, 0x1F, 0x0F, 0x07,0x03	0x3F 0x1F ⁴⁸	Do not Change	1.38
MAC RndTime1Mask	Radio State 1 max. delay mask. First TX	124	0x7F, 0x3F, 0x1F, 0x0F, 0x07,0x03	0x0F	Do not Change	1.38
Reserved		125..127			Do not Change	

⁴⁶ Out of range values will be treated as Disabled

⁴⁷ Command retry default increased to 4 from FW 1.47

⁴⁸ Changed from 0x3F to 0x1F in FW release 1.42 applicable

Calibration Memory

The table below shows the complete list of parameters stored in non-volatile Calibration memory. These values may be changed using the 'HW' command while the module is in Configuration Mode (page 52). All addresses and arguments must be sent as binary values to the module (not as ASCII representation for hex or decimal).

Parameter	Description	Address	Argument	Factory setting	Comment	FW
Radio and protocol configuration						
Temp Offset	Offset added to TEMP	0	0-255	128	Temperature offset in 0.25 degree (C) increments. Increase for positive adjustment, decrease for negative adjustment of TEMP value	1.20
RFPower5		1	0-255		Factory set, do not change	1.20
FREQOFF		2	0-255		Factory set, do not change	1.20
Configuration Mode Time Out	Automatic Time Out setting for Configuration Mode	3	0-255	2	Minutes timer. Activated by Configuration Entry Control setting	1.47
Configuration Mode Entry Key	Key Entry for Two Step Configuration Mode Entry	4	0-255	'K' (0x4B)	Activated by Configuration Entry Control setting	1.47
ADC	Analogue converter Zero calibration	3, 4	0-0xFFFF		Automatically calibrated at first Power On Calibration values moved to RAM memory from 1.47	1.20 1.47
Flash Erase Delay	Delay time from 'M' command initiated in Configuration Mode, until the Flash Erase procedure is initiated	5	0-255	0	Delayed Flash Erase may be activated to reduce possibility of failed flash write in systems with external MCU that performs flash configuration at each Power On Reset, under conditions where Reset Input may bounce from unstable or noisy conditions.	1.51
Reserved		6..22			Do not change	1.51
Network ID	NID 0	23	0-255	0	Unique identifier for host network and Tinymesh Cloud™ NID= NID3:NID2:NID1:NID0	1.31
	NID 1	24	0-255	0		
	NID 2	25	0-255	0		
	NID 3	26	0-255	0		
Fixed Destination ID	FDID 0	27	0-255	0	Permanent Router or End Device connection address. FDID= FDID3:FDID2:FDID1: FDID0 Default = 0:0:0:0 Function disabled	1.36
	FDID 1	28	0-255	0		
	FDID 2	29	0-255	0		
	FDID 3	30	0-255	0		
S4 TimeOut	Additional delay in RF State 4	31	0-255	0 ⁴⁹	Do not Change	1.38
Dispatch Delay	Additional delay for Dispatch Timer	32	0-255	0	Do not Change	1.38
S4 Command Wait	Additional command response wait-time in RF State 4	33	0-255	0	Do not Change	1.40
Device Identifier	Reserved space for device type identifier	34-41	0-255	0,0,0,0,0,0,0,0	Do not Change	1.40

Note: Address locations not listed, should not be changed from their default values

⁴⁹ Default value changed from 5 to 0 starting with Tiymesh version 1.42

Demo Board Exercises

With Radiocrafts TM-CCT examples

Hardware required: Minimum two demo boards

Preparation:

- ⤴ Connect serial ports to computer USB ports.
- ⤴ Open a copy of TM-CCT for each of the connected demo boards.
- ⤴ Select appropriate COM: port at 19200 bps, click the Connect button for each demo board.

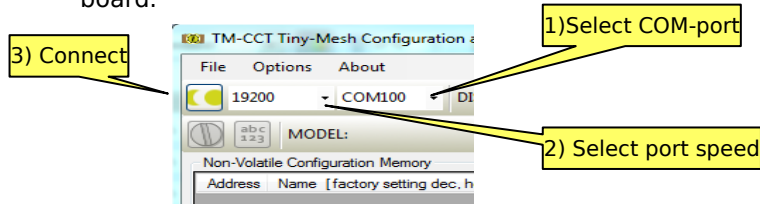

Transparent Mode Communication

- ⤴ Use default configuration settings for Gateway and Router Devices
- ⤴ Transfer serial data from Gateway Device to Router Device
- ⤴ Transfer Serial Data from Router Device to Gateway Device

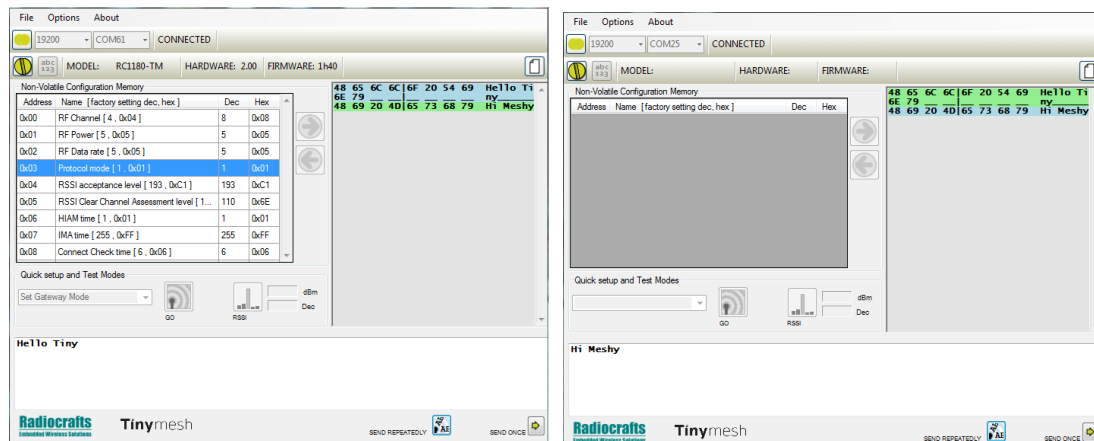
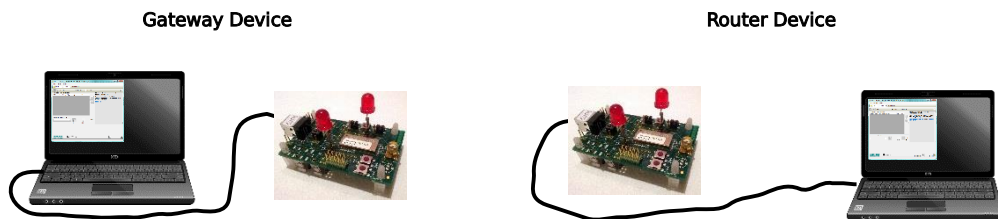

Enter text string, then click

Hello Tiny

Observe text string received in clear text:

Hi Meshy

Observe text string received in clear text:















Hello Tiny

Enter text string, then click

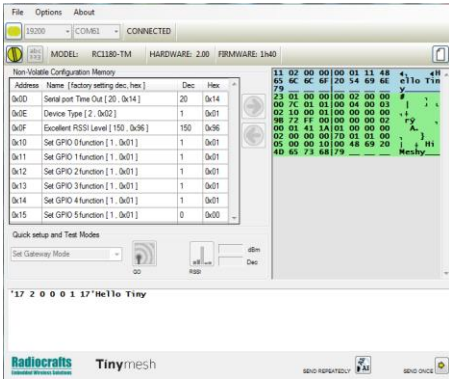
Hi Meshy

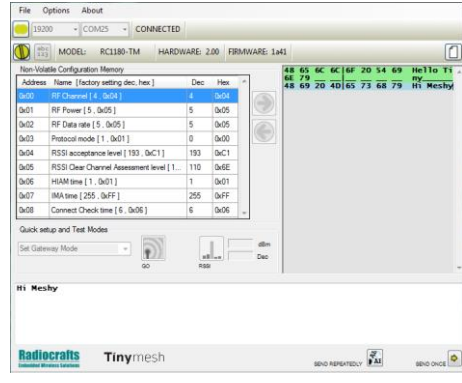

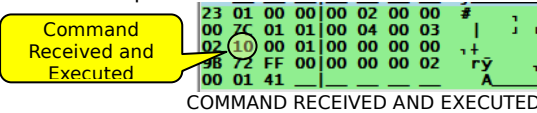
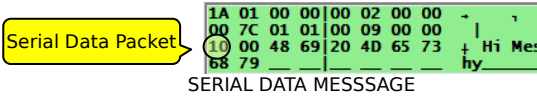

Packet Mode Serial Communication, Test and Demo

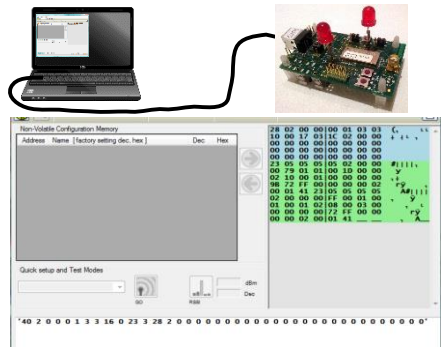
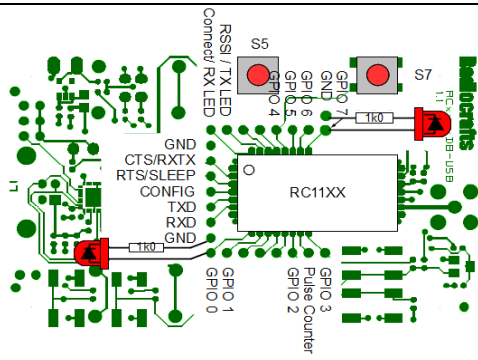

- ▲ Configure the Gateway Device for Packet Mode Operation
- ▲ Set a known Unique ID for Router Board, to enable addressed Communication from Gateway Device
- ▲ Transmit addressed serial data from Gateway Device
- ▲ Transmit transparent (unformatted) serial data from Router Device

<p>Gateway Board Preparations Change Gateway Device from Transparent to Packet Mode operation</p> <ol style="list-style-type: none"> 1. Click , then press the CONFIG button on the Gateway demo board to set the Gateway Device in Configuration mode 2. Click  to read back the Configuration Memory contents 3. Locate the 'Protocol mode' cell 4. Change Protocol Mode to 0, to select Packet Mode 5. Click  to save the new configuration 6. Click  to Exit Configuration Mode 	<p>Router Board Preparations Set known Router Device Address (UID)</p> <ol style="list-style-type: none"> 1. Click , then press the CONFIG button on the Router Demo Board to set the Router Device in Configuration Mode 2. Click  to read back the Configuration Memory contents 3. Scroll down to (0x2a) Unique ID0 cell 4. Set UID0=2, UID1=0, UID2=0, UID3=0 5. Click  to save the new configuration 6. Click  to Exit Configuration Mode
 	 
<p>Transmit from Gateway Device: Enclosed within Apostrophes ('), enter: Packet length (Total number of bytes):17 Router UID: 2 0 0 0 Selectable Command Number: 1 Command Type Serial: 17 Text String:Hello Tiny</p> <p>Enter text string, then click </p> <p>Paste String: '17 2 0 0 0 1 17'Hello Tiny Observe response:</p>  <p>COMMAND RECEIVED AND EXECUTED</p>	<p>Observe: Text string received in clear text</p> <p>Hello Tiny</p>
<p>Observe: Serial Data packet received by Gateway Device:</p>  <p>SERIAL DATA MESSAGE</p>	<p>Transmit from Router Device: Enter text string in clear text, then click </p> <p>Text String: Hi Meshy</p>

Packet Mode Demo: Digital Output Control, PWM Dimming and Input Trigger

- ⤴ Configuring a networked Router Device from the Gateway Device
- ⤴ Controlling a Router Digital Output Port by command from the Gateway Device
- ⤴ Dimming an LED by using the PWM Output feature
- ⤴ Using a digital input to trigger an alarm message.

Assumptions: <ul style="list-style-type: none"> ⤴ Router Device address (UID): 2 0 0 0, Gateway Device in Packet Mode. ⤴ LED indicators connected to Router Device GPIO 0 and GPIO 7 per drawing below ⤴ Gateway Device connected to TM-CCT over USB serial port ⤴ Router Device powered by batteries or USB port 																											
Gateway Device, Setup and actions 	Router Device, Setup and actions 																										
Configuring a networked Router Device from the Gateway Device																											
Desired Configuration: GPIO 0: Output, default High, (Address 16 = 0) GPIO 7: PWM Output, (Address 23 = 3) GPIO 4: Negative Edge Input Trig (Addr 28 = 2) Command String, for desired Configuration: '40 2 0 0 0 1 3 3 16 0 23 3 28 2 0 0 0 0 0 0 0 0 0 0 0 0 0' Paste Command String to TM-CCT, click SEND ONCE  Observe response messages from Router Device: <table border="1" style="margin-top: 10px;"> <tr><td colspan="2">Command Received and Executed</td></tr> <tr><td>23 01 00 00 00 02 00 00 #</td><td>{ L }</td></tr> <tr><td>00 7F 01 01 00 02 00 00</td><td>{ + }</td></tr> <tr><td>9B 72 FF 00 00 00 00 02 r</td><td>rb</td></tr> <tr><td>00 01 41</td><td>A</td></tr> <tr><td colspan="2" style="text-align: center;">COMMAND RECEIVED AND EXECUTED</td></tr> <tr><td colspan="2">Device Reset</td></tr> <tr><td>23 01 00 00 00 02 00 00 #</td><td>{ L }</td></tr> <tr><td>00 EF 00 01 00 01 00 01 y</td><td>{ }</td></tr> <tr><td>02 08 00 03 00 00 00 00</td><td>{ L }</td></tr> <tr><td>00 72 FF 00 00 00 00 02 r</td><td>rb</td></tr> <tr><td>00 01 41</td><td>A</td></tr> <tr><td colspan="2" style="text-align: center;">DEVICE RESET</td></tr> </table>	Command Received and Executed		23 01 00 00 00 02 00 00 #	{ L }	00 7F 01 01 00 02 00 00	{ + }	9B 72 FF 00 00 00 00 02 r	rb	00 01 41	A	COMMAND RECEIVED AND EXECUTED		Device Reset		23 01 00 00 00 02 00 00 #	{ L }	00 EF 00 01 00 01 00 01 y	{ }	02 08 00 03 00 00 00 00	{ L }	00 72 FF 00 00 00 00 02 r	rb	00 01 41	A	DEVICE RESET		Observe: Connect and RSSI LEDs will stop flashing as the Router Device goes through a full Reset Cycle and then re-connects to the Gateway. Connect- and RSSI LEDs resume flashing as the Router Device reconnects to the Gateway. GPIO 7 LED (PWM) = On (0 % Dimming) GPIO 0 LED = On (Output is High)
Command Received and Executed																											
23 01 00 00 00 02 00 00 #	{ L }																										
00 7F 01 01 00 02 00 00	{ + }																										
9B 72 FF 00 00 00 00 02 r	rb																										
00 01 41	A																										
COMMAND RECEIVED AND EXECUTED																											
Device Reset																											
23 01 00 00 00 02 00 00 #	{ L }																										
00 EF 00 01 00 01 00 01 y	{ }																										
02 08 00 03 00 00 00 00	{ L }																										
00 72 FF 00 00 00 00 02 r	rb																										
00 01 41	A																										
DEVICE RESET																											
Controlling a Router Digital Output Port by command from the Gateway Device																											
Set GPIO 0 Low Use Command String: '10 2 0 0 0 1 3 1 0 1' Paste the Command String to TM-CCT, click SEND ONCE  Observe response message from Router Device: <table border="1" style="margin-top: 10px;"> <tr><td colspan="2">Response from</td></tr> <tr><td>02 00 00 00</td><td>{ }</td></tr> <tr><td>00 78 01 01 00 03 00 02 {</td><td>L</td></tr> <tr><td>02 10 00 01 00 00 00 00</td><td>+ }</td></tr> <tr><td>9B 72 FE 00 00 00 00 02 r</td><td>rb</td></tr> <tr><td>00 01 41</td><td>A</td></tr> <tr><td colspan="2" style="text-align: center;">COMMAND RECEIVED AND EXECUTED</td></tr> </table>	Response from		02 00 00 00	{ }	00 78 01 01 00 03 00 02 {	L	02 10 00 01 00 00 00 00	+ }	9B 72 FE 00 00 00 00 02 r	rb	00 01 41	A	COMMAND RECEIVED AND EXECUTED		Observe: GPIO 0 LED = Off (Output is Low)												
Response from																											
02 00 00 00	{ }																										
00 78 01 01 00 03 00 02 {	L																										
02 10 00 01 00 00 00 00	+ }																										
9B 72 FE 00 00 00 00 02 r	rb																										
00 01 41	A																										
COMMAND RECEIVED AND EXECUTED																											
Set GPIO 0 High Use Command String: '10 2 0 0 0 1 3 1 1 0' Paste the Command String to TM-CCT, click SEND ONCE  Observe response message from Router Device: <table border="1" style="margin-top: 10px;"> <tr><td colspan="2">Length of received packet: 0x23 = 35d</td></tr> <tr><td>23 01 00 00 00 02 00 00 #</td><td>{ L }</td></tr> <tr><td>00 78 01 01 00 03 00 02 {</td><td>L</td></tr> <tr><td>02 10 00 01 00 00 00 00</td><td>+ }</td></tr> <tr><td>9B 72 FE 00 00 00 00 02 r</td><td>rb</td></tr> <tr><td>00 01 41</td><td>A</td></tr> </table>	Length of received packet: 0x23 = 35d		23 01 00 00 00 02 00 00 #	{ L }	00 78 01 01 00 03 00 02 {	L	02 10 00 01 00 00 00 00	+ }	9B 72 FE 00 00 00 00 02 r	rb	00 01 41	A	Observe: GPIO 0 LED = Off (Output is Low)														
Length of received packet: 0x23 = 35d																											
23 01 00 00 00 02 00 00 #	{ L }																										
00 78 01 01 00 03 00 02 {	L																										
02 10 00 01 00 00 00 00	+ }																										
9B 72 FE 00 00 00 00 02 r	rb																										
00 01 41	A																										

Dimming an LED by using the PWM Output feature	
<p>Dim GPIO 7 Output by 75% Command String: '10 2 0 0 0 1 3 2 75 0'</p> <p>Paste Command String to RCTool, click </p> <p>Observe response message from Router Device:</p> <div style="border: 1px solid black; padding: 5px; margin-bottom: 5px;">Response to command number 1</div> <pre> 23 01 00 00 00 02 00 00 # 1 00 78 01 01 00 05 00 03 { 1 02 10 00 01 00 00 00 00 } + 98 72 FF 00 00 00 00 02 } r 00 01 41 A </pre> <p style="text-align: center;">COMMAND RECEIVED AND EXECUTED</p>	<p>Observe:</p> <p style="text-align: center;">GPIO 7 LED = Weak (75% dim)</p>
<p>Dim GPIO 7 Output by 100% Command String: '10 2 0 0 0 1 3 2 100 0'</p> <p>Paste Command String to RCTool, click </p> <p>Observe response message from Router Device:</p> <div style="border: 1px solid black; padding: 5px; margin-bottom: 5px;">Packet is Event type</div> <pre> 23 01 00 00 00 02 00 00 # 1 00 78 01 01 00 06 00 03 { 1 02 10 00 01 00 00 00 00 } + 98 72 7F 00 00 00 00 02 } r 00 01 41 A </pre> <p style="text-align: center;">COMMAND RECEIVED AND EXECUTED</p>	<p>Observe:</p> <p style="text-align: center;">GPIO 7 LED = Off (100% dim)</p>
<p>Dim GPIO 7 Output by selectable % Command String: '10 2 0 0 0 1 3 2 nn 0'</p> <p>Change the 'nn' value to the desired dimming level, then Paste the Command String to TM-CCT, click </p> <p>Observe response message from Router Device:</p> <div style="border: 1px solid black; padding: 5px; margin-bottom: 5px;">Packet is Event type</div> <pre> 23 01 00 00 00 02 00 00 # 1 00 78 01 01 00 06 00 03 { 1 02 10 00 01 00 00 00 00 } + 98 72 7F 00 00 00 00 02 } r 00 01 41 A </pre> <p style="text-align: center;">COMMAND RECEIVED AND EXECUTED</p>	<p>Observe:</p> <p style="text-align: center;">GPIO 7 LED = Selected Dimming Level</p>
Using a digital input to trigger an alarm message	
<p>Observe: Message received from Router Device:</p> <div style="border: 1px solid black; padding: 5px; margin-bottom: 5px;">Input Change Detected</div> <div style="border: 1px solid black; padding: 5px; margin-bottom: 5px;">Triggered by GPIO 4</div> <pre> 23 01 00 00 00 02 00 00 # 1 00 70 01 01 00 07 00 00 } 1 02 01 00 10 00 00 00 00 } + 98 72 5F 00 00 00 00 02 } ro 00 01 41 A </pre> <p style="text-align: center;">DIGITAL INPUT CHANGE DETECTED</p>	<p>Trig GPIO 4 Press S7 button</p>

End Device Test and Demo, Pulse Counter with Feedback

- ⤴ Configure End Device as Pulse Counter with Feedback
- ⤴ Receive periodic pulse counter status on Gateway Device
- ⤴ Change and observe effect of De-bounce Timer
- ⤴ Observe value of Pulse Counter Feedback LED

Assumptions:

- ⤴ End Device address (UID): 3 0 0 0
- ⤴ Gateway Device in Packet Mode.
- ⤴ LED connected to End Device GPIO 7
- ⤴ End Device Switch S7 connected to Pulse Counter port (Add strap per drawing below)
- ⤴ Gateway Device connected to TM-CCT over USB serial port
- ⤴ End Device Device connected to TM-CCT over USB serial port for initial Configuration

Gateway Device, Setup and actions	End Device, Setup and actions
-----------------------------------	-------------------------------

Quick setup and Test Mode

GO

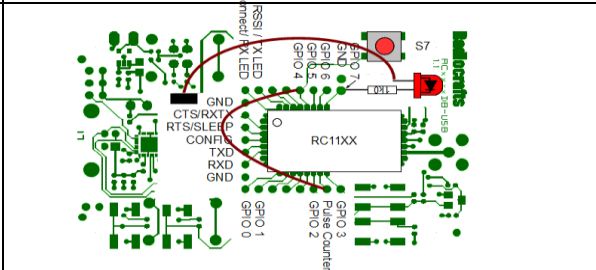

Set End Device Demo Board in Configuration Mode

Select End Device, click 'GO' button:

Set new configurations:

	Address		Data
	Hex	Dec	
IMA Time	7	7	10
GPIO7 Function	0x17	23	0
IMA Time Base	0x55	85	0
Wakeup Enable GPIO(8)+IMA(1)=9	0x57	87	9
Pulse Counter Mode	0x60	96	1
Pulse Counter Feedback Port	0x68	104	7
Feedback Enable	0x69	105	2
IMA Data Field Contents	0x6A	106	2

Click to write new configuration settings
Click to exit Configuration Mode

Observe:

Device Reset

```

23 01 00 00 | 00 03 00 00 | # | L
00 7D 01 01 | 00 01 00 28 | } | C
02 09 00 02 | 00 00 00 00 | , | I
93 71 FB 00 | 00 00 00 02 | qu | A
00 01 41 | - - - - - | - | -
    
```

Observe:

RSSI and Connect LEDs flashing briefly while establishing connection to Gateway Device, then Off, as device goes to sleep

Observe each 10 seconds:

Counter status

```

23 01 00 00 | 00 03 00 00 | # | L
00 7F 01 01 | 00 17 00 00 | , | I
02 09 00 18 | 00 00 00 00 | , | I
00 71 FB 00 | 00 00 00 02 | qu | A
00 01 41 | - - - - - | - | -
    
```

Press S7 button to simulate pulse input

Observe:
Short flash on Pulse Counter Feedback LED
random glitches on pressing and releasing switch

Observe each 10 seconds:

Counter status

```

23 01 00 00 | 00 03 00 00 | # | L
00 7F 01 01 | 00 45 00 00 | , | E
02 09 00 2F | 00 00 00 00 | , | I
90 71 FB 00 | 00 00 00 02 | qu | A
00 01 41 | - - - - - | - | -
    
```

STATUS MESSAGE (IMA)

Add 10ms De-bounce Timer:

Re-enter Configuration Mode

Pulse Counter De-bounce Time	0x61	97	10
------------------------------	------	----	----

Click , Click to exit Configuration Mode

Observe each 10 seconds:

Counter status

```

23 01 00 00 | 00 03 00 00 | # | L
00 7F 01 01 | 00 45 00 00 | , | E
02 09 00 2F | 00 00 00 00 | , | I
90 71 FB 00 | 00 00 00 02 | qu | A
00 01 41 | - - - - - | - | -
    
```

STATUS MESSAGE (IMA)

Press S7 button to simulate pulse input

Observe:
Short flash on Pulse Counter Feedback LED,
No glitches on pressing and releasing switch

Antenna Connection

The antenna should be connected to the RF pin. The RF pin is matched to 50 Ohm. If the antenna connector is placed away from the module at the motherboard, the track between the RF pin and the connector should be a 50-Ohm transmission line.

On a two layer board made of FR4 the width of a micro strip transmission line should be 1.8 times the thickness of the board, assuming a dielectric constant of 4.8. The line should be run at the top of the board, and the bottom side should be a ground plane.

Example: For a 1.6 mm thick FR4 board, the width of the trace on the top side should be $1.8 \times 1.6 \text{ mm} = 2.88 \text{ mm}$.

The simplest antenna to use is the quarter wave whip antenna. A quarter wave whip antenna above a ground plane yields 37-Ohm impedance and a matching circuit for 50 Ohm is usually not required.

A PCB antenna can be made as a copper track where the ground plane is removed on the backside. The rest of the PCB board should have a ground plane as large as possible, preferably as large as the antenna itself, to make it act as a counterweight to the antenna. If the track is shorter than a quarter of a wavelength, the antenna should be matched to 50 ohms.

The lengths of a quarter-wave antenna for different operational frequencies are given in the table below.

Frequency [MHz]	Length [cm]
433	16.4
865-867	8.2
868	8.2
915	7.8
2450	2.9

PCB Layout Recommendations

The recommended layout pads for the module are shown in the figures below. All dimensions are in thousands of an inch (mil). The circle in upper left corner is an orientation mark only, and should not be a part of the copper pattern.

The RC17xx(HP)-TM layout pattern covers all solder pads for all module versions, and is recommended for PCB designs in products that require flexibility in module selection.

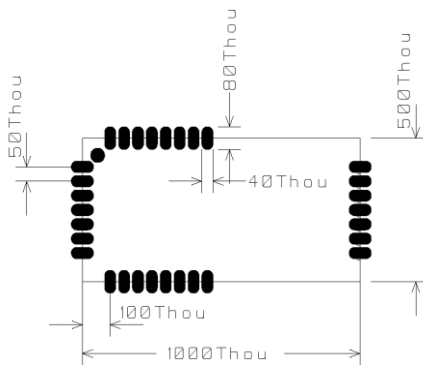

RC11XX(HP)-TM, RC25xx(HP)-TM

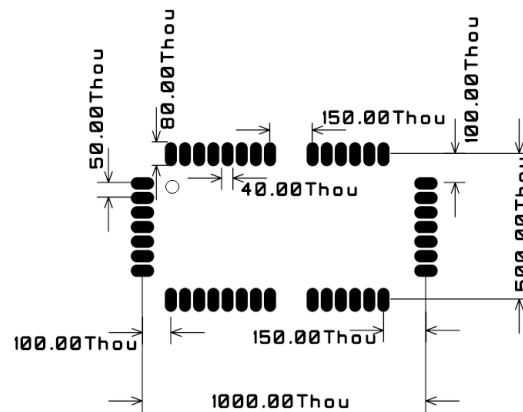

RC17xx(HP)-TM

A PCB with two or more layers and with a **single**, solid ground plane in **one** of the **inner-** or **bottom** layer(s) is recommended. Multiple GND layers should be avoided, as it is challenging to achieve sufficiently low impedance between multiple layers. All GND-pins of the module shall be connected to this ground plane with vias with shortest possible routing, one via per GND-pin.

On the backside of the module, there are several test pads. These test pads shall not be connected, and the area underneath the module should be covered with solder resist. If any routing or vias is required under the module, the routing and vias must be covered with solder resist to prevent short-circuiting of the test pads. It is recommended that vias be tented.

Reserved pins should be soldered to the pads but the pads must be left floating.

Note that Radiocrafts technical support team is available for schematic and layout review of your design.

Mechanical Drawings

Mechanical drawing, RC11xx / RC25xx

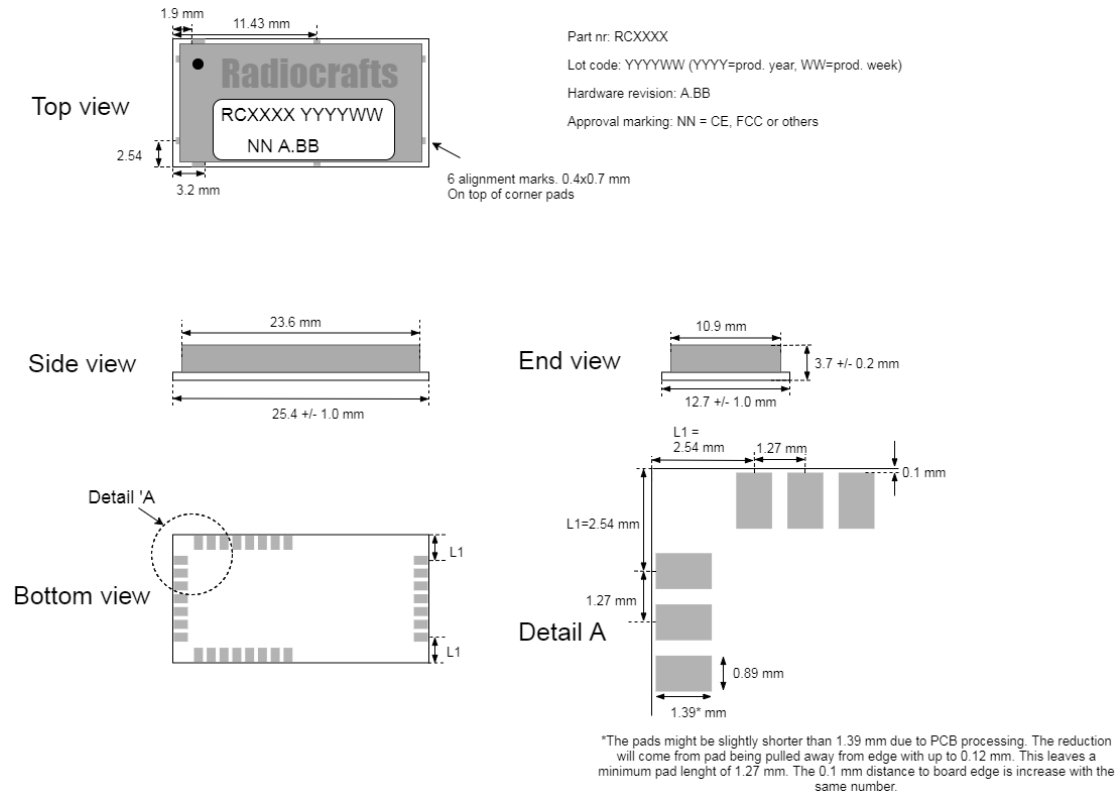

Mechanical drawing, RC11xxHP / RC25xxHP

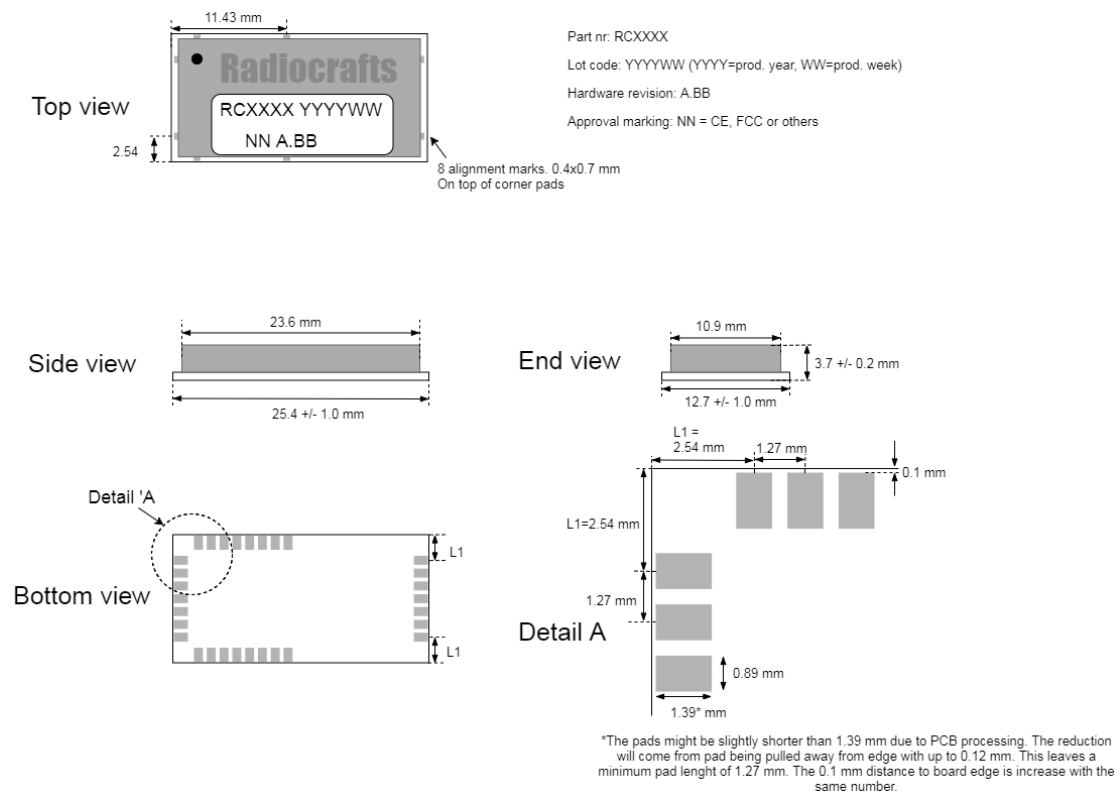

Mechanical drawing, RC17xx(HP)

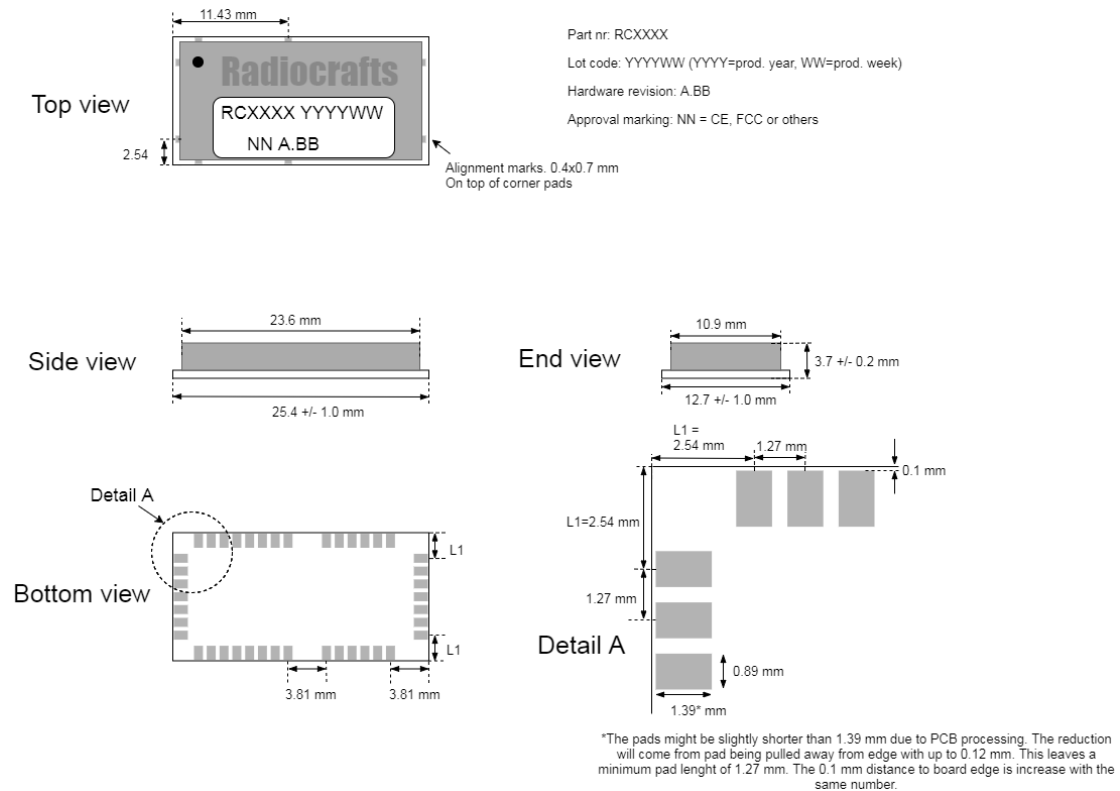

Mechanical Dimensions

The module size is 12.7 x 25.4 x 3.7 mm.

Carrier Tape and Reel Specification

Carrier tape and reel is in accordance with EIA Specification 481.

Tape width	Component pitch	Hole pitch	Reel diameter	Units per reel
44 mm	16 mm	4 mm	13"	Max 1000

Soldering Profile Recommendation

JEDEC standard IEC/JEDEC J-STD-020B (page 11 and 12), Pb-Free Assembly is recommended.

The standard requires that the heat dissipated in the "surroundings" on the PCB is taken into account. The peak temperature should be adjusted so that it is within the window specified in the standard for the actual motherboard.

Aperture for paste stencil is normally areal-reduced by 20-35%. Nominal stencil thickness of 0.1 -0-12 mm is recommended. Consult your production facility for best experience aperture reduction.

Cleaning and welding Recommendation

Ultrasonic processes like ultrasonic cleaning and ultrasonic welding to assemble plastic enclosures may cause deterioration or destruction of components in high power RC11xxHP modules, and should be avoided.

Absolute Maximum Ratings

Parameter	Min	Max	Unit
Supply Voltage, VCC			
RC11XX-TM	-0.3	3.9	V
RC11XXHP-TM	-0.3	3.6	
RC2500-TM	-0.3	3.9	
RC2500HP-TM	-0.3	3.6	
RC17XX(HP)-TM	-0.3	3.9	
RC1701HP-TM	-0.3	3.8	
Supply Voltage, VCC_PA			
RC17XXHP-TM	-0.3	5.5	V
RC1701HP-TM	-0.3	3.8	
Voltage on any pin	-0.3	VCC+0.3V, never exceeding Max value	V
Input RF level		10	dBm
Storage temperature	-50	150	°C
Operating temperature (RC17xx(HP))	-40 -30	85 85	°C

*Caution! ESD sensitive devices.
Precaution should be used when
handling the device in order to
prevent permanent damage.*

Under no circumstance, the absolute maximum ratings given above should be violated. Stress exceeding one or more of the limiting values may cause permanent damage to the device.

RC11XX(HP)-TM and RC17XX(HP)-TM devices may be powered by Lithium Cell batteries with nominal output voltage of 3.6V. Fresh Lithium Cell batteries often have an open circuit voltage higher than their nominal 3.6V rating. Such cells may be used to power the module as long as the supply voltage never exceeds the absolute maximum rating of the module. When the module operates in IDLE/RX/TX, the loaded battery voltage will usually drop to fall inside the module operating voltage range as referenced in table ELECTRICAL SPECIFICATIONS.

Note: RC11xxHP-TM and RC2500HP-TM have absolute maximum ratings close to the nominal output of a 3.6V Li Cell, and must not be connected directly to a battery without introducing a voltage drop between the module and the battery.

Electrical Specifications

T=25°C, VCC = 3.0V if nothing else stated.

Parameter	Min	Typ.	Max	Unit	Condition / Note
Operating frequency					
RC114x-TM	433.05	433.400	434.79	MHz	
RC117x(HP)-TM	865.0	865.700	867.0		
RC118x-TM	868.0	868.350	870.0		
RC118xHP-TM	868.0	869.525	870.0		
RC119x(HP)-TM	902.0	904.000	928.0		
RC2500(HP)-TM	2400.75	2403.75	2483.75		
RC1701(HP)-TM	169.4000	169.40625	169.475		
RC1740(HP)-TM	424.6875	433.07750	444.250		
RC1760(HP)-TM	457.5000	458.51250	467.600		
RC1780(HP)-TM	865.0000	869.51250	870.650		
Number of channels					RC118xHP-TM has a total of 18 channels, of which 3 may transmit with 500mW
RC114x-TM		17			
RC117x(HP)-TM		15			
RC118x(HP)-TM		18			
RC119x(HP)-TM		50			
RC2500(HP)-TM		83			
RC1701(HP)-TM		13			
RC1740(HP)-TM		173			
RC1760(HP)-TM		239			
RC1780(HP)-TM		94			
Input/output impedance		50		Ohm	
Data rate		1.2 4.8 19.0 ⁵⁰ 19.2 ⁵¹ 32.768 50 76.8 100 250 ⁵²		kbit/s	
Frequency stability			+/- 40 +/- 20 +/- 1.5	ppm	Including 10 years of ageing.
RC11xx(HP)-TM					
RC2500(HP)-TM					
RC17xx(HP)-TM					
Frequency stability ageing			1 5	ppm/year ppm/10 Years	Starting after 10 years
Transmit power					
RC114x-TM - RC118x-TM	-20		11	dBm	
RC117xHP-TM- RC119xHP-TM	0		27		
RC119x-TM	-20		-1		
RC2500-TM	-15		1		
RC2500HP-TM	-10		18		
RC17xxHP-TM		27	27.5		
RC17xx-TM		15	16		
FSK Deviation, 17xx(HP)-TM					
1.2 kbps		+/- 2.4		kHz	
9.6 kbps		+/- 4.8			
19.2kbps		+/- 7.2/2.4			
50kbps		+/- 25			
100kbps		+/- 38.4			
Adjacent Channel Power					
RC17xx(HP)-TM ⁵³			< -20	dBm	
12.5kHz Channels			< -37		
25 and 50 kHz Channels					

⁵⁰ RC11XX(HP)-TM

⁵¹ RC2500(HP)-TM, RC17xx(HP)-TM

⁵² RC119xHP-TM and RC2500(HP)

⁵³ The RC17x0HP-TM module should be characterized as a wideband system for 25 kHz and wider channels under EN300-220-2 V2.4.1. The 25 kHz narrow band ACP requirement will limit the output power to +22 dBm when characterised as 25 kHz channel under EN300-220-2. For 12.5 kHz narrow band systems the RC17x0HP-TM complies with ACP up to +27 dBm.

Parameter	Min	Typ.	Max	Unit	Condition / Note
RC114x-RC119x-TM (LP&HP) Spurious emission, TX < 1 GHz > 1 GHz 47 – 74 MHz 87.5 – 118 MHz 174 – 230 MHz 470 – 862 MHz			-36 -30 -54 -54 -54 -54	dBm	
RC2500(HP)- TM Spurious emission,TX,1 dBm 30-1000 MHz 1 - 12.75 GHz 1.8 - 1.9 GHz 5.15 - 5.33 GHz			-36 -30 -47 -47	dBm	Complies with EN 300 328, EN 300 440, FCC CFR47 Part 15 and ARIB STD#T66
RC2500(HP)- TM, Spurious emission,TX,10 dBm 30 - 1000 MHz 1 - 12.75 GHz 1.8 - 1.9 GHz 5.15 - 5.33 GHz			-36 -30 -47 -47	dBm	Complies with EN 300 328, EN 300 440, FCC CFR47 Part 15 and ARIB STD#T66
RC2500(HP)- TM, Spurious emission,TX,20 dBm 30 - 1000 MHz 1 - 12.75 GHz 1.8 - 1.9 GHz 5.15 - 5.33 GHz			-36 -30 -47 -47	dBm	FCC CFR47 Part 15 and ARIB STD#T66
RC17xx(HP)-TM, Spurious emission, TX < 1 GHz > 1 GHz Restricted Bands			-36 -30 -54	dBm	Restricted bands: 47 MHz - 74 MHz 87.5 MHz - 118 MHz 174 MHz - 230 MHz 470 MHz - 862 MHz
Sensitivity RC114x-RC119x-TM (LP&HP) 1.2 kbit/s 4.8 kbit/s 19.0 kbit/s 32.768 kbit/s 76.8 kbit/s 100 kbit/s RC2500-TM 1.2 kbit/s 4.8 kbit/s 19.0 kbit/s 32.768 kbit/s 76.8 kbit/s 100 kbit/s RC2500HP- TM 1.2 kbit/s 4.8 kbit/s 19.0 kbit/s 32.768 kbit/s 76.8 kbit/s 100 kbit/s RC17XX(HP)-TM 1.2 kbit/s 9.6 kbit/s 19.2 kbit/s 50 kbit/s 100 kbit/s		-110 -106 -104 -101 -99 -97 -105 -103 -101 -99 -91 -89 -108 -105 -101 -100 -92 -91 -117 -113 -109 -110 -106 -107 -101		dBm	1% packet error rate, 20 bytes packet length
Adjacent channel rejection RC11xx - 25xx-TM RC11xxHP-TM, 25xxHP-TM RC17xxHP-TM		29 27 64		dB	

Parameter	Min	Typ.	Max	Unit	Condition / Note
Alternate channel selectivity RC11xx(HP)/25xx(HP)-TM RC17XX(HP)-TM		53 66		dB	
Image channel rejection RC11xx(HP)/25xx(HP)-TM RC17XX(HP)-TM		28 66		dB	
Blocking / Interferer rejection / desensitization RC114x-RC119x-TM (LP&HP) +/- 1 MHz +/- 2 MHz +/- 5 MHz +/- 10 MHz RC2500(HP) TM Blocking / Interferer rejection /desensitization +/- 10 MHz +/- 20 MHz +/- 50 MHz RC17xx(HP)-TM +/- 1 MHz +/- 2 MHz +/- 10 MHz	30 35 50 60	43 49 68 72 55 60 60 82 83 89		dB	Wanted signal 3 dB above sensitivity level, CW interferer. Minimum numbers corresponds to class 2 receiver requirements in EN300220. Wanted signal 3 dB above sensitivity level, modulated interferer. BER=0.1% Compliant to class 2 receiver requirements in EN 300 440 class 2 Wanted signal 3 dB above sensitivity level, CW interferer. Minimum numbers corresponds to class 2 receiver requirements in EN300220.
Saturation RC114x-RC119x-TM (LP&HP) RC2500-TM RC2500HP-TM RC17xx(HP)-TM		-14 -10 -20 +10		dBm	
Input IP3		-14		dB	
Spurious emission, RX 30 - 1000 MHz 1 - 12.75 GHz			-57 -47	dBm	Complies with EN 300 328, EN 300 440, FCC CFR47 Part 15, and ARIB STD#T66
Supply Voltage RC114x - RC119x-TM RC117xHP-TM-RC119xHP-TM RC2500-TM RC2500HP-TM RC17xx-TM RC17xxHP-TM VCC VCC_PA RC1701HP-TM VCC VCC_PA	2.0 3.0 2.0 2.7 2.8 2.8 2.8 2.8 2.8		3.6 3.3 3.6 3.6 3.6 3.6 5.0 3.6 3.6	V	
Current consumption, RX/IDLE RC114x-RC119x-TM (LP&HP) RC2500-TM RC2500HP-TM RC17xx(HP)-TM VCC VCC_PA		24 25 40 31 3 *10 ⁻⁴		mA	Apply over entire supply voltage range

Parameter	Min	Typ.	Max	Unit	Condition / Note
Current consumption, TX RC114x-TM -20 dBm -10 dBm 0 dBm 5 dBm 9 dBm RC117x- RC119x-TM -20 dBm -10 dBm 0 dBm 5 dBm 9 dBm RC2500-TM 1 dBm RC117xHP- RC119xHP-TM 0 dBm 10 dBm 14 dBm 25 dBm 27 dBm RC2500HP-TM -10 dBm 0 dBm 5 dBm 10 dBm 18 dBm RC1701HP-TM +14 dBm +17 dBm +20 dBm +24 dBm +27 dBm RC1740HP-TM/ 1760HP-TM +14 dBm +17 dBm +20 dBm +24 dBm +27 dBm RC1780HP-TM +14 dBm +17 dBm +20 dBm +24 dBm +27 dBm RC17xx-TM +15 dBm		18 20 22 25 35 16 17 22 30 37 27 20 60 80 530 560 80 80 80 80 155 VCC+VCC_PA 103 132 173 268 407 VCC_PA/ VCC 134/35 141/36 174/37 248/42 318/63 VCC_PA/ VCC 128/36 128/39 154/41 234/46 297/72 57			
Current consumption, SLEEP RC114x- RC119x-TM RC117xHP-TM-RC119xHP-TM RC2500-TM RC2500HP-TM RC17xx(HP)-TM VCC VCC_PA		0.3 3.4 0.4 1.3 0.6 0.02	1.0 10.0 1.0 2.0 2.0 1.0		uA
Digital I/O Input logic level, low Input logic level, high Output logic level, low (1µA) Output logic level,high(-1µA)	70 % 0		30 % VCC		V Of VCC Of VCC
SET pin Input logic level, low Input logic level, high	70 %		30 %		V Minimum 250 ns pulse width

Parameter	Min	Typ.	Max	Unit	Condition / Note
UART Baud Rate tolerance		+/- 2		%	UART receiver and transmitter
Configuration memory write cycles	1000				The guaranteed number of write cycles using the 'M' command is limited
PWM switching frequency		1		kHz	Applies to GPIO 7 when configured for PWM

Regulatory Compliance Information

The use of RF frequencies and maximum allowed RF power is limited by national regulations. The RC114x-TM and RC118x(HP)-TM have been designed to comply with the EU RED directive. According to the RED directive, it is the responsibility of Radiocrafts' customers (i.e. the RC11XX-TM end user) to check that the host product (i.e. final product) is compliant to the RED essential requirements. The use of a CE marked radio module can avoid re-certification of the final product, provided that the end user respects the recommendations given by Radiocrafts. A Declaration of Conformity is available from Radiocrafts on request.

- The RC119x-TM has been tested towards FCC regulations for license free operation under part 15. However, a final approval is required by FCC for the end product.
- The RC117x-TM and RC117xHP-TM have been tested towards G.S.R.564(E) and G.S.R.168(E) for license free use in India. The Gazettes are available from Radiocrafts on request.
- The RC117x-TM and RC117xHP-TM comply to IEEE 802.15.4.g PHY Mode ID 0 encoding when configured for RF Data Rate 8.
- The RC2500(HP)-TM has been designed to comply with the RED directive in Europe, FCC regulation and ARIB regulation. To comply with the different standards, the output power should be configured as commented below.

RED directive (EU)

According to the EU RED directive, it is the responsibility of Radiocrafts customers to check that the host product (i.e. final product) is compliant with the RED essential requirements. The use of a CE marked radio module can avoid re-certification of the final product, provided that the end user respects the recommendations established by Radiocrafts. A Declaration of Conformity is available from Radiocrafts on request.

In terms of RED compliance, the RC2500HP-TM is a narrowband radio and must comply with EN 300 328 on those premises. This implies that the radiated power must be lower than 10 dBm, **and hence only power level setting 4 and lower may be used for compliance to EN 300 328.**

In order to comply with the spectrum access requirements given in EN 300 220-2, an external application using the module for serial data transmission, should limit amount of serial data by introducing minimum time delays between each time data is dispatched. The below table indicates the minimum time delay between serial data dispatch at given data rates with default configuration settings.

For module applications that dispatch Event Data based on internal timer (IMA Timer) or when meeting digital- or analogue trigger conditions, the application should be designed to ensure minimum time between each Event Data dispatch, per below table.

RF Data rate kbps	0.3	0.6	1.2	2.4	4.8	9.6	19	19.2	38.4	50	76.8	100	250	
HIAM Time Seconds	26	18	12	8	5	4	3	3	2	1	1	1	1	
Serial Buffer Fill Delay	10% Duty Cycle	96.8 s	48.3 s	24.1 s	12.0 s	5.89 s	2.86 s	1.36 s	1.34 s	586 ms	410 ms	207 ms	119 ms	0
	1% Duty Cycle	968.9 s	483.1 s	240.7 s	119.5 s	58.89 s	28.59 s	13.59 s	13.44 s	5.86 s	4.10 s	2.07 s	1.19 s	0
Min. time between Event data dispatch	10% Duty Cycle	41.9 s	18.8 s	8.8 s	4.2 s	2.06 s	0.99 s	491 ms	486 ms	240 ms	188 ms	120 ms	92 ms	36 ms
	1% Duty Cycle	- s	- s	- s	- s	280 s	22.4 s	7.78 s	7.64 s	3.29 s	3.25 s	1.65 s	1.16 s	394 ms

FCC Compliance (US, Canada)

The RC2500(HP)-TM has been tested towards FCC regulations for license free operation under part 15. However, a final approval is required by FCC for the end product. Output power is limited to EIRP of -1.25dBm for compliance to part 15, §249. This corresponds to power level 4 in RC2500-TM. The maximum power density must be < 8dBm/3kHz. At full output power for RC2500HP-TM (setting 5), the spreading 6 dB bandwidth (BW) of the signal must be larger than 500 kHz. The required BW may be achieved by using the highest data rate 250 kbit/s. The RC 119x-TM is pre-tested for FCC compliance, using -1dBm output power.

WPC Compliance (India)

License based operation in India is based on case by case grant and the basis is normally a compliance to RED directive (CE) or FCC.

ARIB Compliance

The RC2500(HP)-TM has been designed to comply with the requirements given by the Japanese ARIB STD#T66 for low power (short range) devices in the 2.4GHz range. However, it has not been assessed for conformity with the appropriate regulations.

Regulatory Compliance Disclaimer

Users must assess and verify that their final product meets the appropriate specifications and to perform the required procedures for regulatory compliance. The relevant regulations are subject to change. Radiocrafts AS does not take responsibility for the validity and accuracy of the understanding of the regulations referred above. Radiocrafts only guarantee that this product meets the specifications in this document. Radiocrafts is exempt from any responsibilities related to regulatory compliance.

Typical Application Circuit

Typical application designs using Tinymesh modules may or may not have an external MCU. The embedded Tinymesh application firmware will in most cases handle all desired I/O functions without needing the support of an external MCU. Recommended circuit design for implementation of RESET, CONFIG and UART signals depends on whether the application will use an external MCU or not.

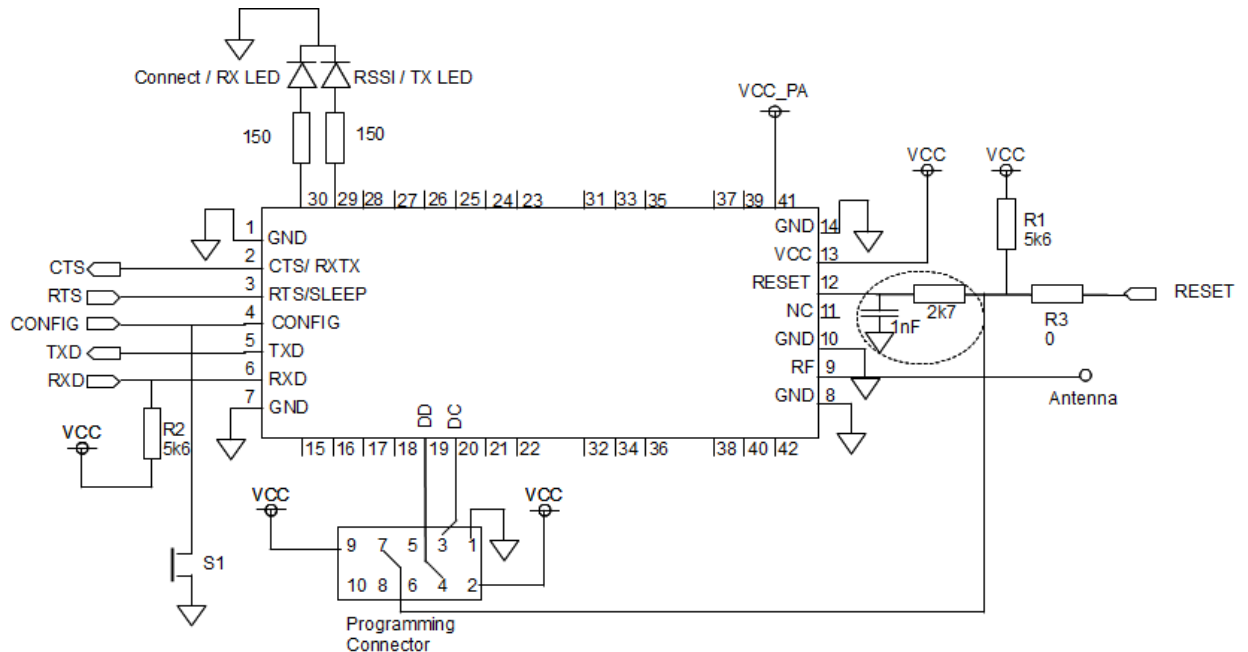

Typical Tinymesh module application diagram for RC11xx(HP)-TM, 2500(HP)-TM and RC17xx(HP)-TM modules.

Notes:

- VCC_PA is only applicable for RC17xxHP-TM
- The 2k7/ 1nF Reset RC filter in dotted outline is mandatory for RC11xx(HP)-TM modules, and not applicable for RC17xx(HP)-TM modules.
When deploying RC17xx(HP) modules in circuits designed to cover all module versions, the 2k7 resistor should be replaced by a zero ohm resistor, and the 1nF capacitor should not be mounted.
- R1 is mandatory in noisy surroundings unless RESET is driven by a push-pull output. If a lower value resistor than 5k6 is used, an external programmer used for firmware upgrade may not be able to pull the RESET input fully low.
- R2 is mandatory in noisy environments unless RXD is driven by a push-pull output
- R3 is a zero ohm resistor, and should be removed when using the programming interface for device re-flash, if the RESET signal is driven by a push-pull output e.g. an MCU or a supervisory circuit.
- The two indicator LEDs 'Connect/RX' and 'RSSI/TX' are highly recommended as aids for verification of proper function during installation, test and development stages.
- S1 is a push button switch for activating Configuration Mode in applications designed for local configuration over the serial port, with no MCU
- It is recommended to include a 2x5 pins programming connector to the module programming pins, to enable future firmware updates. The connector should be a 1.27 mm pitch pin-row (same pitch in both directions), SMD or through-hole version.
- For recommended connection of CONFIG, RESET and UART pins, please see table below

Application Circuit			
	No MCU, No Serial Port	No MCU, with Serial Port	MCU with serial port
Typical Function	I/O controller - Wireless sensors - Street lights - PWM or On/Off	I/O controller with serial port. - Wireless cable replacement - MODBUS - Serial / optical port metering interface	External MCU with full I/O and serial port control
Module Configuration Options	- Over the air SET CONFIGURATION Command	- Over the air SET CONFIGURATION Command - Serial port configuration in CONFIGURATION MODE	- Over the air SET CONFIGURATION Command - MCU serial port configuration in CONFIGURATION MODE
Recommended Circuit Connections			
RESET	Apply Pull Up (R1) to VCC or Connect to Supervisory Circuit through R3		MCU I/O through R3 No pull-up
	Zero ohm R3 must be removed to allow device reprogramming through Programming Connector		
CONFIG	N/C	Push-button (S1) To enable Configuration Mode for configuration by serial port	MCU I/O
CTS	N/C	Serial port / level shifter input. Mandatory hardware handshake signal, indicating module ready to receive data.	MCU UART input Mandatory hardware handshake signal, indicating Module ready to receive data
RTS	N/C	N/C or Output for RXTX direction control of RS485 level shifter	N/C or MCU I/O used as control signal for Module Sleep
TXD	N/C	Serial port / level shifter input	MCU UART input
RXD	Apply Pull Up (R2) to VCC	Serial port / level shifter output. Apply Pull Up (R2) to VCC unless driven by a push-pull output	MCU UART output Apply Pull Up (R2) to VCC unless driven by a push-pull output

Power Supply

Noisy external circuitry may under certain scenarios affect the TX signal, and precaution should be taken for EU RED conformity. Example of circuits that may generate noise on the transmitted spectrum may be DC/DC converters and some level converters like RS232 and RS485. To increase spectrum margin it is important to add an EMI filter bead on the VCC pin of the module. Alternatively the module may be powered from a separate voltage regulator. This will ensure that potential switching noise is filtered out from the power supply to the module. A block diagram of a typical PC serial port interface is illustrated below.

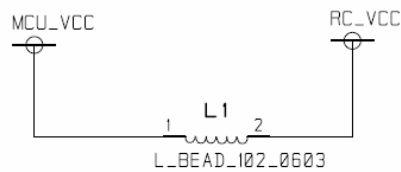

Component	Manufacturer	Part number
EMI filter bead	Murata	BLM11A102S, ordering code BLM18xx102xN1D For High Power versions of modules use BLM18SG331TN1

Appendix: ASCII Table

HEX	DEC	CHR	CTRL
0	0	NUL	^@
1	1	SOH	^A
2	2	STX	^B
3	3	ETX	^C
4	4	EOT	^D
5	5	ENQ	^E
6	6	ACK	^F
7	7	BEL	^G
8	8	BS	^H
9	9	HT	^I
0A	10	LF	^J
0B	11	VT	^K
0C	12	FF	^L
0D	13	CR	^M
0E	14	SO	^N
0F	15	SI	^O
10	16	DLE	^P
11	17	DC1	^Q
12	18	DC2	^R
13	19	DC3	^S
14	20	DC4	^T
15	21	NAK	^U
16	22	SYN	^V
17	23	ETB	^W
18	24	CAN	^X
19	25	EM	^Y
1A	26	SUB	^Z
1B	27	ESC	
1C	28	FS	
1D	29	GS	
1E	30	RS	
1F	31	US	
20	32	SP	
21	33	!	
22	34	"	
23	35	#	
24	36	\$	
25	37	%	
26	38	&	
27	39	'	
28	40	(
29	41)	
2A	42	*	
2B	43	+	
2C	44	,	
2D	45	-	
2E	46	.	
2F	47	/	
30	48	0	
31	49	1	
32	50	2	
33	51	3	
34	52	4	
35	53	5	
36	54	6	
37	55	7	
38	56	8	
39	57	9	
3A	58	:	
3B	59	;	
3C	60	<	
3D	61	=	
3E	62	>	
3F	63	?	

HEX	DEC	CHR
40	64	@
41	65	A
42	66	B
43	67	C
44	68	D
45	69	E
46	70	F
47	71	G
48	72	H
49	73	I
4A	74	J
4B	75	K
4C	76	L
4D	77	M
4E	78	N
4F	79	O
50	80	P
51	81	Q
52	82	R
53	83	S
54	84	T
55	85	U
56	86	V
57	87	W
58	88	X
59	89	Y
5A	90	Z
5B	91	[
5C	92	\
5D	93]
5E	94	^
5F	95	_
60	96	`
61	97	a
62	98	b
63	99	c
64	100	d
65	101	e
66	102	f
67	103	g
68	104	h
69	105	i
6A	106	j
6B	107	k
6C	108	l
6D	109	m
6E	110	n
6F	111	o
70	112	p
71	113	q
72	114	r
73	115	s
74	116	t
75	117	u
76	118	v
77	119	w
78	120	x
79	121	y
7A	122	z
7B	123	{
7C	124	
7D	125	}
7E	126	~
7F	127	DEL

Document Revision History

Doc Revision	FW Release ---/UNB	Changes
1.0	1.0	First release
1.01	1.01	Packet mode description added
1.02	1.02	Gateway packet mode received packet description adjusted
1.03	1.03	Gateway LED description, Configuration memory address spec, misc. text adjustments
1.04	1.04	1160, 2500 and HP versions added, timing info added, specs updated
1.1	1.1	Correction of some misprints (frequencies and article numbers)
1.15	1.15	Added Locator-function information. Added Test Mode 3 and 5. Added I/O control and analogue sampling section Changed all I/O naming references to GPIO
1.16	1.16	Added PWM, IMA On Connect description, Added Output config description, Added Config Commands, minor text changes
1.17	1.17	Corrected Received Packet Format, Serial data packets, byte 18. Adjusted default values. Minor text changes/ corrections
1.18	1.18	Added specification for GPIO output drive. Adjusted text for PCB layout.
1.19	1.19	Corrected some configuration-memory default settings. Updated information on End Devices. Corrected default channel for RC1180HP-TM.
1.35	1.35	Major additions, new features
1.35 a	1.35 a	Added PWM frequency specification
1.36	1.36	Added 256 bytes serial input buffer capacity feature Changed various default configuration settings
1.36 a	1.36 a	Minor changes, default values
1.38	1.38	RC1160-TM version included in RC 118x-TM. Introduced versions RC1141-TM, RC1171(HP)-TM and RC1181(HP)-TM
1a40.. 1x41	1a40.. 1x41	Pre-release, Including End Device, several new settings and functions
1.42	1.42	Major additions and new features, including End Device New chapter on practical demo cases
1.43	1.43	Corrected error in Message Data description for Event Detail 16 and 17
1.45	1.45/1.01	Added UNB devices RC17xx(HP), Test Mode 2, Auto selected Config values, new RC 1181-TM module (To be released)
1.46	1.46/1.02	Corrected details in Quick Reference Data, Absolute Maximum Ratings. Minor corrections and omissions in text and reference data
1.47		Added Welding and Cleaning Recommendations chapter
1.48		Update and corrections for RC118x(HP) variants
1.49	1.47	Added new configuration commands and defaults for FW release 1.47, corrected minor flaws
1.51	1.51	Added selectable Calibration Memory setting for Flash Erase delay, Synchronized data sheet revision to FW release.
1.52	1.52	Added Output Toggle command, module modulation format, minor corrections and formatting
1.52.1	1.52	Updated Mechanical drawing and height information. Please refer to Hardware PCN for revision history. Updated regulatory compliance. EU RED replaces EU R&TTE.

Product Status and Definitions

Current Status	Data Sheet Identification	Product Status	Definition
	Advance Information	Planned or under development	This data sheet contains the design specifications for product development. Specifications may change in any manner without notice.
	Preliminary	Engineering Samples and First Production	This data sheet contains preliminary data, and supplementary data will be published at a later date. Radiocrafts reserves the right to make changes at any time without notice in order to improve design and supply the best possible product.
X	No Identification Noted	Full Production	This data sheet contains final specifications. Radiocrafts reserves the right to make changes at any time without notice in order to improve design and supply the best possible product.
	Obsolete	Not in Production	This data sheet contains specifications on a product that has been discontinued by Radiocrafts. The data sheet is printed for reference information only.

Disclaimer

Radiocrafts AS believes the information contained herein is correct and accurate at the time of this printing. However, Radiocrafts AS reserves the right to make changes to this product without notice. Radiocrafts AS does not assume any responsibility for the use of the described product; neither does it convey any license under its patent rights, or the rights of others. The latest updates are available at the Radiocrafts website or by contacting Radiocrafts directly.

As far as possible, major changes of product specifications and functionality, will be stated in product specific Errata Notes published at the Radiocrafts website. Customers are encouraged to check regularly for the most recent updates on products and support tools.

Trademarks

Tinymesh™ is a trademark of Tiny Mesh AS. The Tinymesh™ Embedded RF Protocol is used in a range of products from Radiocrafts. The protocol handles host communication, data buffering, error check, addressing and broadcasting. It supports transparent and packet-addressed mesh topologies.

All other trademarks, registered trademarks and product names are the sole property of their respective owners.

Life Support Policy

This Radiocrafts product is not designed for use in life support appliances, devices, or other systems where malfunction can reasonably be expected to result in significant personal injury to the user, or as a critical component in any life support device or system whose failure to perform can be reasonably expected to cause the failure of the life support device or system, or to affect its safety or effectiveness. Radiocrafts AS customers using or selling these products for use in such applications do so at their own risk and agree to fully indemnify Radiocrafts AS for any damages resulting from any improper use or sale.

© 2018, Radiocrafts AS. All rights reserved.

Contact Information

Web sites: www.radiocrafts.com

www.tinymesh.com

Address: **Radiocrafts AS**
Sandakerveien 64
NO-0484 OSLO
Norway

Tiny Mesh as
c/o CWi AS
M:6, Elisabeth von Hübschs gate 6
NO-1534 Moss
Norway

Tel: +47 4000 5195
E-mail: sales@radiocrafts.com
support@radiocrafts.com

+47 92268419
sales@tiny-mesh.com
support@tiny-mesh.com