



# SGM8262-2

## High Speed, Ultra-Low Noise, Rail-to-Rail Output, High Output Current Amplifier

---

### GENERAL DESCRIPTION

The SGM8262-2 is a dual, low noise, high speed operational amplifier with voltage feedback function. The output swing is rail-to-rail with heavy loads. This maximizes the dynamic range and offers high linearity.

The SGM8262-2 features  $3.5\text{nV}/\sqrt{\text{Hz}}$  low voltage noise at 100kHz with ultra-low distortion. It also has 22MHz wide bandwidth at -3dB and  $33\text{V}/\mu\text{s}$  high slew rate. The device is unity-gain stable and provides high output drive capability.

The SGM8262-2 is available in Green SOIC-8 and TDFN-3×3-8BL packages. It operates over an ambient temperature range of  $-40^{\circ}\text{C}$  to  $+85^{\circ}\text{C}$ .

### FEATURES

- **Ultra-Low Noise:**
  - Voltage Noise:**  $3.5\text{nV}/\sqrt{\text{Hz}}$  at 100kHz
  - Current Noise:**  $4\text{pA}/\sqrt{\text{Hz}}$  at 100kHz
- **High Speed:**
  - 3dB Bandwidth:** 22MHz (G = +1)
  - Slew Rate:**  $33\text{V}/\mu\text{s}$  ( $R_{\text{LOAD}} = 32\Omega$ )
- **Unity-Gain Stable**
- **High Output Current with Excellent Linearity:** 310mA
- **High Open-Loop Gain:** 110dB
- **Rail-to-Rail Output**
- **Support Single or Dual Power Supplies:**
  - 4.5V to 36V or  $\pm 2.25\text{V}$  to  $\pm 18\text{V}$
- **$-40^{\circ}\text{C}$  to  $+85^{\circ}\text{C}$  Operating Temperature Range**
- **Available in Green SOIC-8 and TDFN-3×3-8BL Packages**

### APPLICATIONS

Audio Processing  
General-Purpose AC Equipment  
Twisted-Pair Wiring Drivers

# High Speed, Ultra-Low Noise, SGM8262-2 Rail-to-Rail Output, High Output Current Amplifier

## PACKAGE/ORDERING INFORMATION

MODEL	PACKAGE DESCRIPTION	SPECIFIED TEMPERATURE RANGE	ORDERING NUMBER	PACKAGE MARKING	PACKING OPTION
SGM8262-2	SOIC-8	-40°C to +85°C	SGM8262-2YS8G/TR	SGM 82622YS8 XXXXX	Tape and Reel, 2500
	TDFN-3x3-8BL	-40°C to +85°C	SGM8262-2YTDD8G/TR	SGM 82622DD XXXXX	Tape and Reel, 4000

### MARKING INFORMATION

NOTE: XXXXX = Date Code and Vendor Code.

**XXXXX**

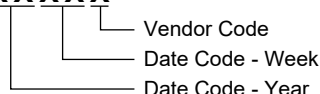

Green (RoHS & HSF): SG Micro Corp defines "Green" to mean Pb-Free (RoHS compatible) and free of halogen substances. If you have additional comments or questions, please contact your SGMICRO representative directly.

### ABSOLUTE MAXIMUM RATINGS

Supply Voltage.....	40V
Input Voltage Range .....	(-V <sub>S</sub> ) - 0.3V to (+V <sub>S</sub> ) + 0.3V
Input Current (All pins except power supply pins).....	±10mA
Junction Temperature.....	+150°C
Storage Temperature Range .....	-65°C to +150°C
Lead Temperature (Soldering, 10s).....	+260°C
ESD Susceptibility	
HBM.....	8000V
MM.....	400V
CDM .....	1000V

### RECOMMENDED OPERATING CONDITIONS

Operating Temperature Range .....	-40°C to +85°C
-----------------------------------	----------------

### OVERSTRESS CAUTION

Stresses beyond those listed in Absolute Maximum Ratings may cause permanent damage to the device. Exposure to absolute maximum rating conditions for extended periods

may affect reliability. Functional operation of the device at any conditions beyond those indicated in the Recommended Operating Conditions section is not implied.

### ESD SENSITIVITY CAUTION

This integrated circuit can be damaged if ESD protections are not considered carefully. SGMICRO recommends that all integrated circuits be handled with appropriate precautions. Failure to observe proper handling and installation procedures can cause damage. ESD damage can range from subtle performance degradation to complete device failure. Precision integrated circuits may be more susceptible to damage because even small parametric changes could cause the device not to meet the published specifications.

### DISCLAIMER

SG Micro Corp reserves the right to make any change in circuit design, or specifications without prior notice.

**PIN CONFIGURATIONS**

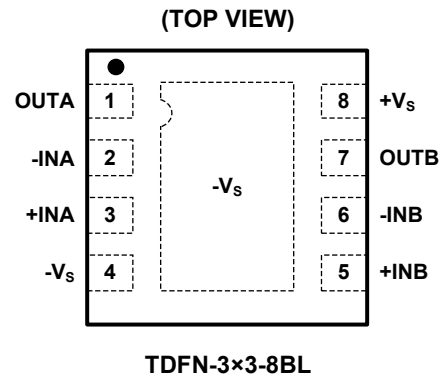
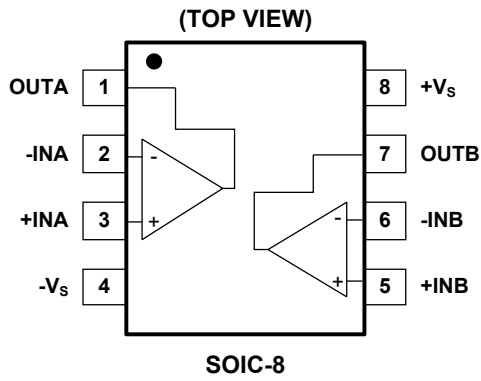

NOTE: For TDFN-3x3-8BL package, connect thermal die pad to -Vs.

# High Speed, Ultra-Low Noise, SGM8262-2 Rail-to-Rail Output, High Output Current Amplifier

## ELECTRICAL CHARACTERISTICS

(At  $T_A = +25^\circ\text{C}$ ,  $V_S = 4.5\text{V}$  to  $36\text{V}$  or  $V_S = \pm 2.25\text{V}$  to  $\pm 18\text{V}$ ,  $G = +1$ ,  $R_{LOAD} = 32\Omega$ ,  $V_{CM} = V_{OUT} = V_S/2$ , unless otherwise noted.)<sup>(1)</sup>

PARAMETER	CONDITIONS	MIN	TYP	MAX	UNITS
<b>DC Performance</b>					
Input Offset Voltage ( $V_{OS}$ )			$\pm 100$	$\pm 500$	$\mu\text{V}$
	$-40^\circ\text{C}$ to $+85^\circ\text{C}$			$\pm 610$	
Input Offset Voltage Match			$\pm 100$	$\pm 700$	$\mu\text{V}$
Input Offset Voltage Drift ( $\Delta V_{OS}/\Delta T$ )			0.5		$\mu\text{V}/^\circ\text{C}$
Input Bias Current ( $I_B$ )	$V_{CM} = V_S/2$		$\pm 40$	$\pm 300$	nA
	$-40^\circ\text{C}$ to $+85^\circ\text{C}$			$\pm 370$	
Input Offset Current ( $I_{OS}$ )	$V_{CM} = V_S/2$		$\pm 10$	$\pm 120$	nA
Open-Loop Voltage Gain ( $A_{OL}$ )	$V_{OUT} = \pm 1\text{V}$ , $V_S = \pm 2.5\text{V}$ or $5\text{V}$	109	115		dB
	$V_{OUT} = \pm 2\text{V}$ , $V_S = \pm 5\text{V}$ or $10\text{V}$	106	115		
	$V_{OUT} = \pm 3\text{V}$ , $V_S = \pm 18\text{V}$ or $36\text{V}$	95	110		
<b>Input Characteristics</b>					
Differential Input Impedance	$V_S = \pm 2.25\text{V}$ or $4.5\text{V}$		38    20		k $\Omega$    pF
	$V_S = \pm 18\text{V}$ or $36\text{V}$		45    15		
Common Mode Input Impedance	$V_S = \pm 2.25\text{V}$ or $4.5\text{V}$		4    6		G $\Omega$    pF
	$V_S = \pm 18\text{V}$ or $36\text{V}$		20    5		
Input Common Mode Voltage Range ( $V_{CM}$ )		$(-V_S) + 2$		$(+V_S) - 2$	V
Common Mode Rejection Ratio (CMRR)	$\Delta V_{CM} = \pm 0.5\text{V}$ , $V_S = \pm 2.5\text{V}$ or $5\text{V}$	107	130		dB
	$\Delta V_{CM} = \pm 1\text{V}$ , $V_S = \pm 18\text{V}$ or $36\text{V}$	109	125		
<b>Output Characteristics</b>					
Output Voltage Swing from Rail ( $V_{OH}$ )	$R_{LOAD} = 32\Omega$ , $V_S = \pm 2.5\text{V}$ to $\pm 5\text{V}$ or $V_S = 5\text{V}$ to $10\text{V}$		0.72	1.1	V
Output Voltage Swing from Rail ( $V_{OL}$ )			0.51	0.64	V
Output Voltage Swing from Rail ( $V_{OH}$ )	$R_{LOAD} = 100\Omega$		1.1	1.6	V
Output Voltage Swing from Rail ( $V_{OL}$ )			0.8	1	V
Peak AC Output Current <sup>(2)</sup>	SFDR $\leq -65\text{dBc}$ , $f = 100\text{kHz}$ , $V_{OUT} = 0.4V_{P-P}$ , $R_{LOAD} = 1\Omega$ , $V_S = \pm 2.25\text{V}$ or $4.5\text{V}$		200		mA
	SFDR $\leq -55\text{dBc}$ , $f = 100\text{kHz}$ , $V_{OUT} = 20V_{P-P}$ , $R_{LOAD} = 32\Omega$ , $V_S = \pm 12\text{V}$ or $24\text{V}$		310		
<b>Dynamic Performance</b>					
-3dB Gain-Bandwidth Product	$V_{OUT} = 0.1V_{P-P}$		22		MHz
0.1dB Flatness	$V_{OUT} = 0.1V_{P-P}$		1.6		MHz
Large-Signal Bandwidth	$V_{OUT} = 0.5V_{P-P}$ , $V_S = \pm 2.25\text{V}$ or $4.5\text{V}$		23		MHz
	$V_{OUT} = 2V_{P-P}$ , $V_S = \pm 18\text{V}$ or $36\text{V}$		12		
Slew Rate (SR)	$V_{OUT} = 0.5V_{P-P}$ , $V_S = \pm 2.25\text{V}$ or $4.5\text{V}$		27		V/ $\mu\text{s}$
	$V_{OUT} = 1V_{P-P}$ , $V_S = \pm 2.5\text{V}$ or $5\text{V}$		33		
	$V_{OUT} = 4V_{P-P}$ , $V_S = \pm 5\text{V}$ or $10\text{V}$		49		
	$V_{OUT} = 4V_{P-P}$ , $V_S = \pm 12\text{V}$ or $24\text{V}$		34		
<b>Noise/Distortion Performance</b>					
Distortion (Worst Harmonic)	$f_C = 100\text{kHz}$ , $V_{OUT} = 1V_{P-P}$ , $G = +2$ , $V_S = \pm 2.25\text{V}$ or $4.5\text{V}$		-95		dBc
	$f_C = 100\text{kHz}$ , $V_{OUT} = 2V_{P-P}$ , $G = +2$ , $V_S = \pm 2.5\text{V}$ or $5\text{V}$		-93		
	$f_C = 100\text{kHz}$ , $V_{OUT} = 6V_{P-P}$ , $G = +2$ , $V_S = \pm 5\text{V}$ or $10\text{V}$		-88		
	$f_C = 100\text{kHz}$ , $V_{OUT} = 20V_{P-P}$ , $G = +5$ , $V_S = \pm 12\text{V}$ or $24\text{V}$		-52		
Input Voltage Noise Density ( $e_n$ )	$f = 100\text{kHz}$		3.5		$\text{nV}/\sqrt{\text{Hz}}$
Input Current Noise Density ( $i_n$ )	$f = 100\text{kHz}$		4		$\text{pA}/\sqrt{\text{Hz}}$

# High Speed, Ultra-Low Noise, Rail-to-Rail Output, High Output Current Amplifier

## SGM8262-2

### ELECTRICAL CHARACTERISTICS (continued)

(At  $T_A = +25^\circ\text{C}$ ,  $V_S = 4.5\text{V}$  to  $36\text{V}$  or  $V_S = \pm 2.25\text{V}$  to  $\pm 18\text{V}$ ,  $G = +1$ ,  $R_{\text{LOAD}} = 32\Omega$ ,  $V_{\text{CM}} = V_{\text{OUT}} = V_S/2$ , unless otherwise noted.)<sup>(1)</sup>

PARAMETER	CONDITIONS	MIN	TYP	MAX	UNITS
<b>Power Supply</b>					
Operating Voltage Range (Dual Supply)		$\pm 2.25$		$\pm 18$	V
Supply Current/Amplifier ( $I_Q$ )			9	11.5	mA
Power Supply Rejection Ratio (PSRR)	$\Delta V_S = \pm 0.5\text{V}$	100	115		dB
<b>Audio Performance</b>					
Total Harmonic Distortion + Noise (THD+N)	$f = 1\text{kHz}$ , $V_{\text{OUT}} = 0.5V_{\text{P-P}}$ , $V_S = \pm 2.25\text{V}$ or $4.5\text{V}$ , BW = 80kHz		0.0006		%
			-104		dB
	$f = 1\text{kHz}$ , $V_{\text{OUT}} = 1V_{\text{P-P}}$ , $V_S = \pm 2.5\text{V}$ or $5\text{V}$ , BW = 80kHz		0.0003		%
			-110		dB
	$f = 1\text{kHz}$ , $V_{\text{OUT}} = 6V_{\text{P-P}}$ , $V_S = \pm 5\text{V}$ or $10\text{V}$ , BW = 80kHz		0.00005		%
			-126		dB
	$f = 1\text{kHz}$ , $V_{\text{OUT}} = 3V_{\text{RMS}}$ , $V_S = \pm 12\text{V}$ or $24\text{V}$ , BW = 80kHz		0.00005		%
			-126		dB

**NOTES:**

1. Unity-gain can facilitate characterization. It is recommended to use a gain of 2 or greater to improve stability.
2. Peak AC output current is only for normal AC operation, and continuous DC operation is invalid.

**TYPICAL PERFORMANCE CHARACTERISTICS**

At  $T_A = +25^\circ\text{C}$ ,  $V_S = \pm 5\text{V}$ ,  $R_{LOAD} = 32\Omega$ , unless otherwise noted.

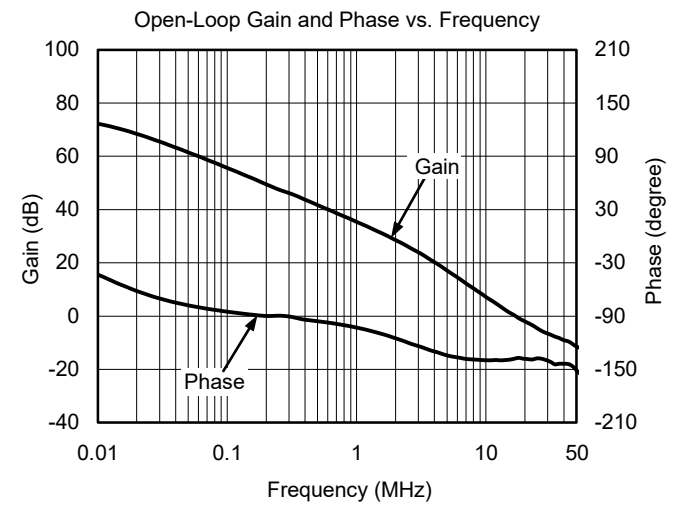
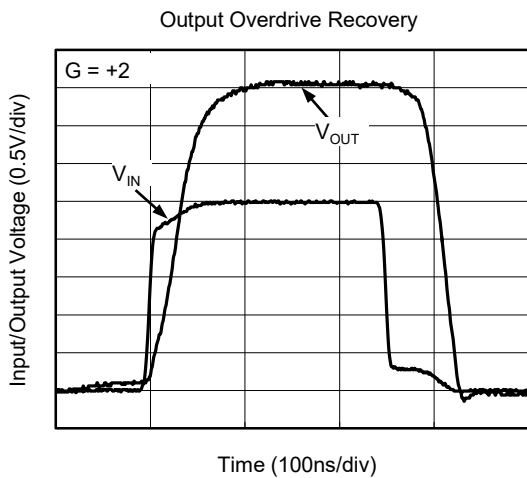
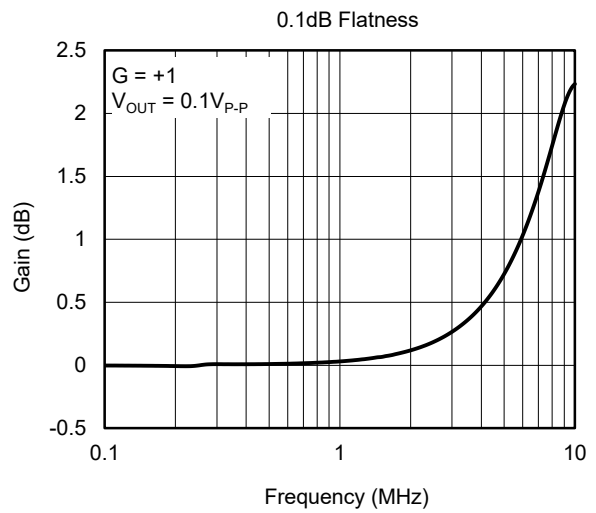
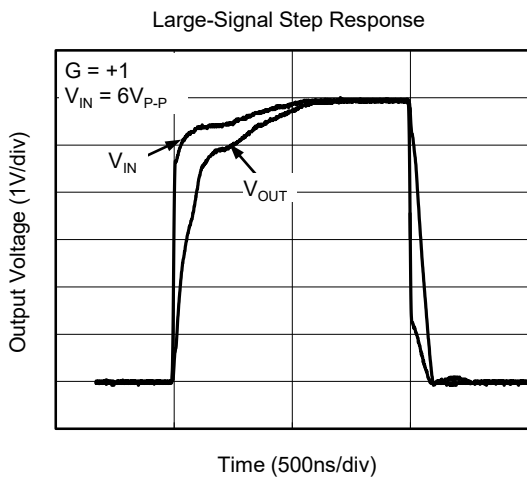
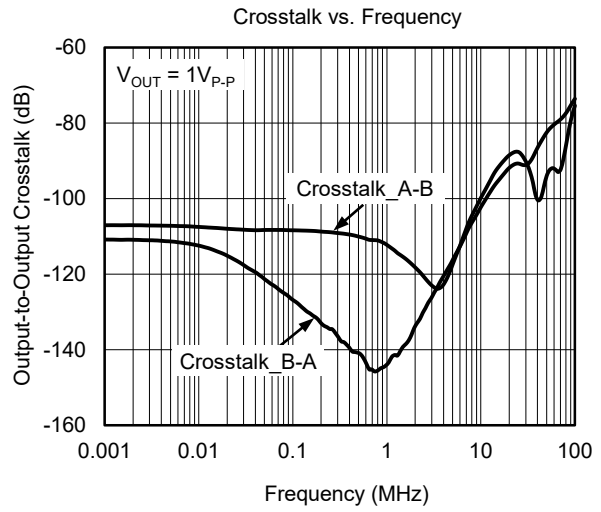
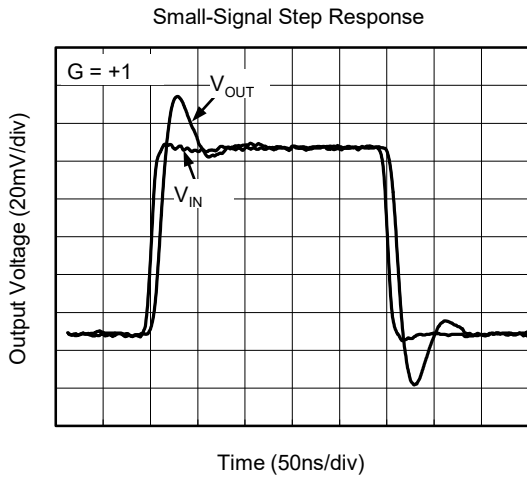

**TYPICAL PERFORMANCE CHARACTERISTICS (continued)**

At  $T_A = +25^\circ\text{C}$ ,  $V_S = \pm 5\text{V}$ ,  $R_{LOAD} = 32\Omega$ , unless otherwise noted.

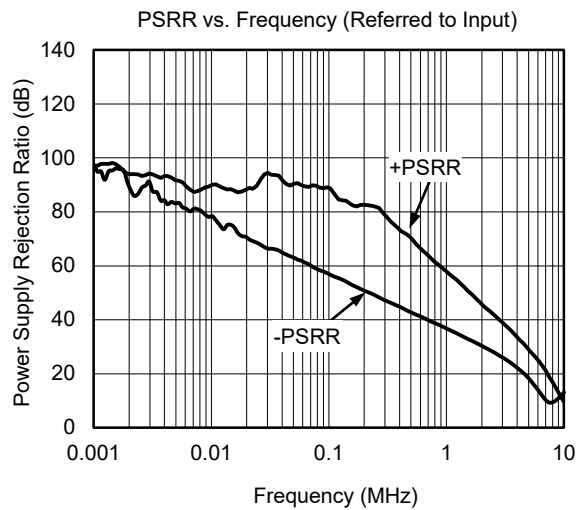
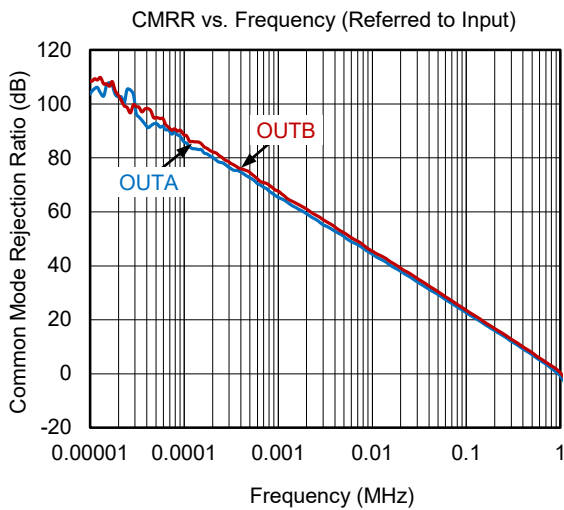
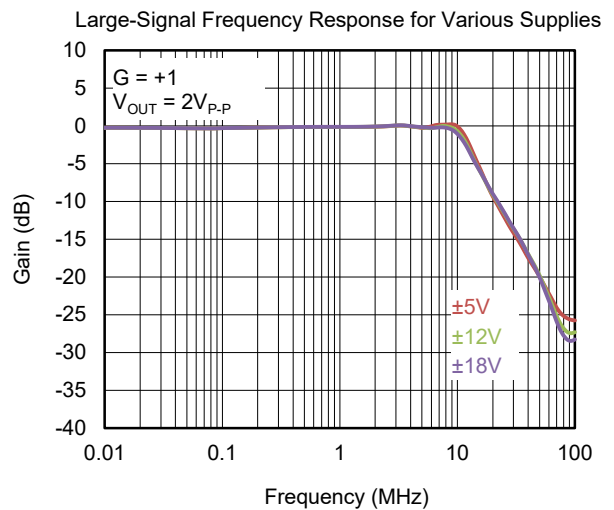
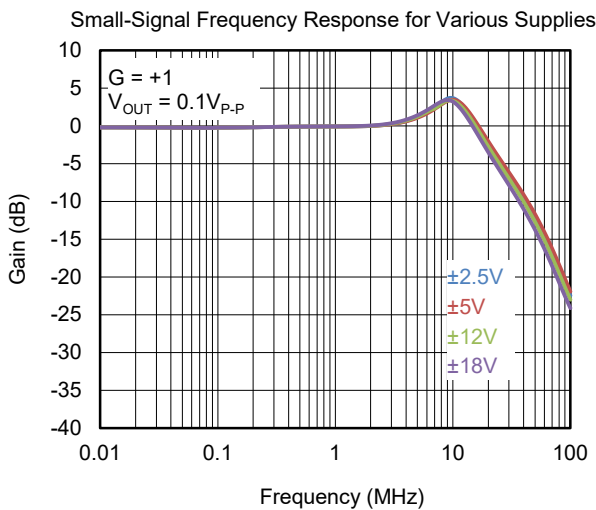
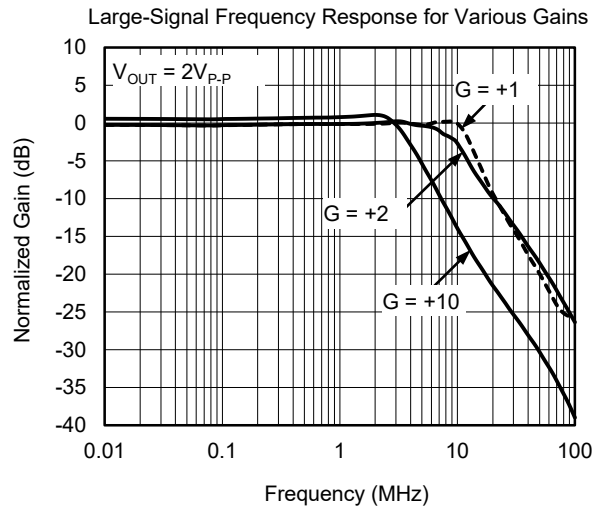
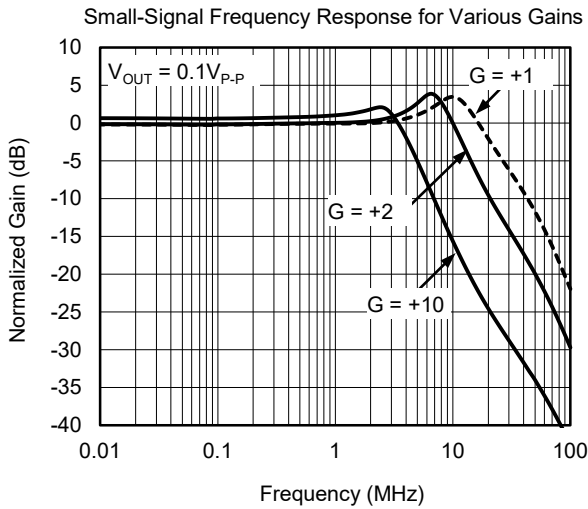

**TYPICAL PERFORMANCE CHARACTERISTICS (continued)**

At  $T_A = +25^\circ\text{C}$ ,  $V_S = \pm 5\text{V}$ ,  $R_{LOAD} = 32\Omega$ , unless otherwise noted.

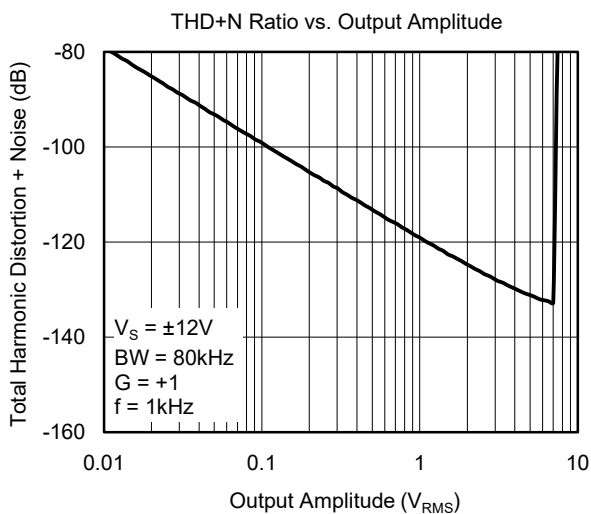
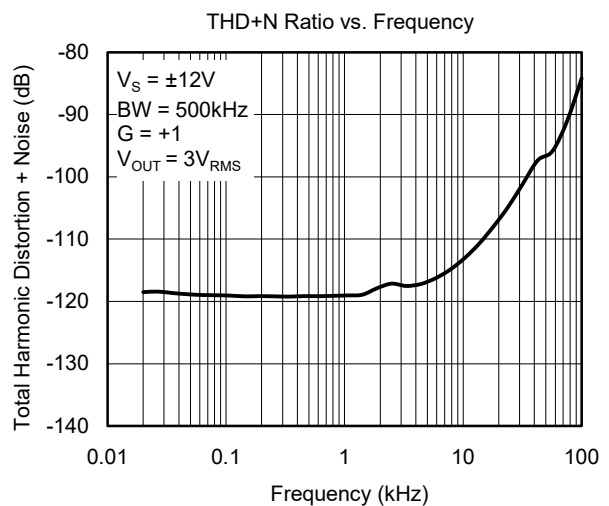
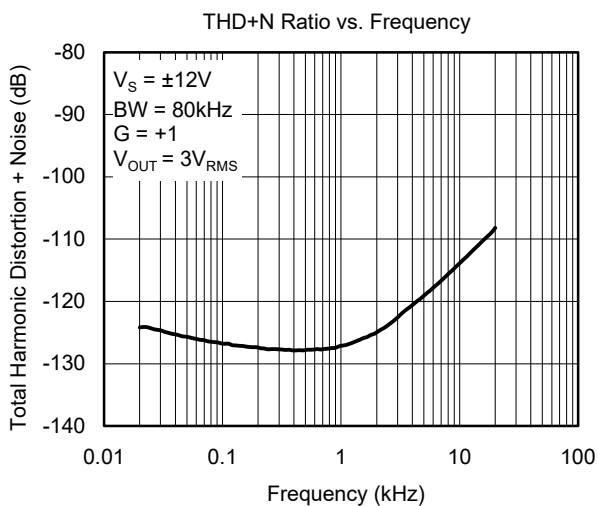
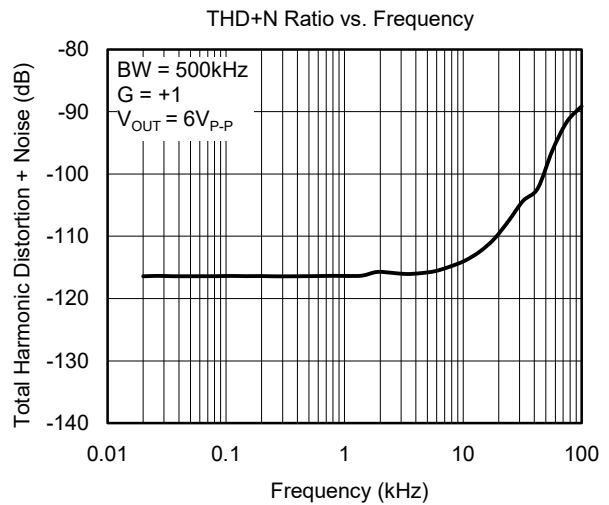
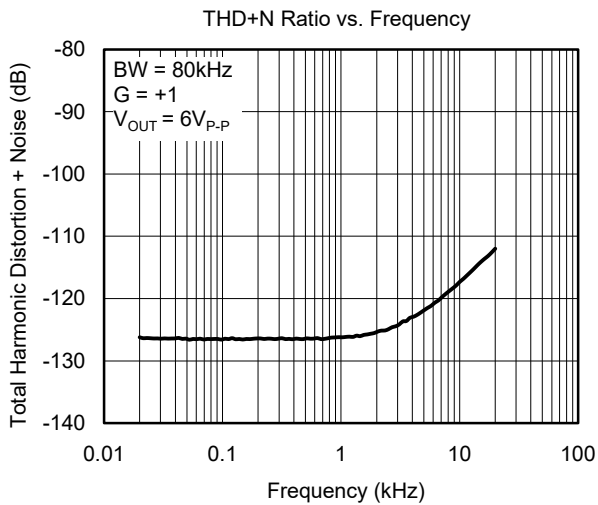



**REVISION HISTORY**

NOTE: Page numbers for previous revisions may differ from page numbers in the current version.

<b>Changes from Original (JUNE 2017) to REV.A</b>	<b>Page</b>
Changed from product preview to production data.....	All

---

PACKAGE OUTLINE DIMENSIONS

SOIC-8

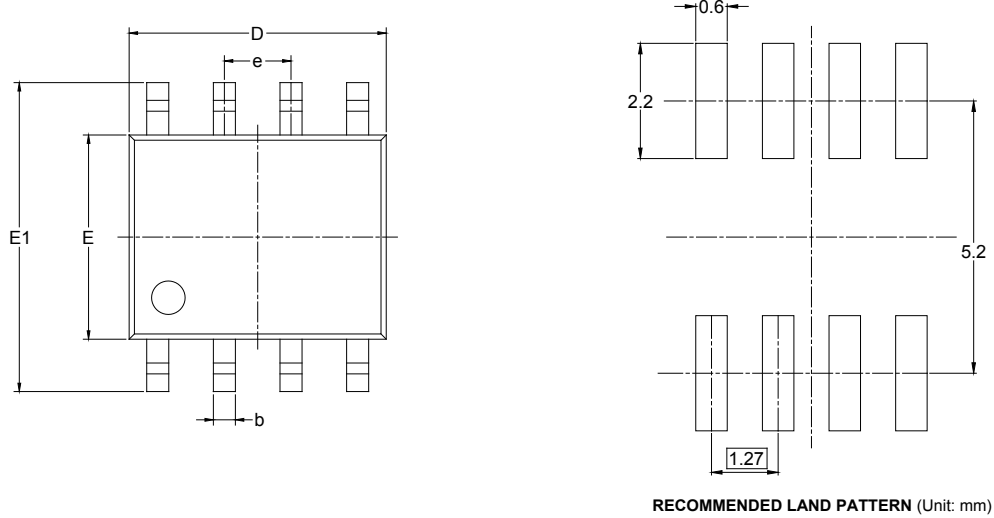

Symbol	Dimensions In Millimeters		Dimensions In Inches	
	MIN	MAX	MIN	MAX
A	1.350	1.750	0.053	0.069
A1	0.100	0.250	0.004	0.010
A2	1.350	1.550	0.053	0.061
b	0.330	0.510	0.013	0.020
c	0.170	0.250	0.006	0.010
D	4.700	5.100	0.185	0.200
E	3.800	4.000	0.150	0.157
E1	5.800	6.200	0.228	0.244
e	1.27 BSC		0.050 BSC	
L	0.400	1.270	0.016	0.050
$\theta$	0°	8°	0°	8°

PACKAGE OUTLINE DIMENSIONS

TDFN-3x3-8BL

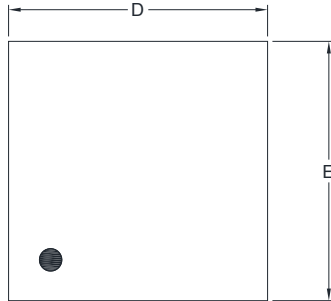

TOP VIEW

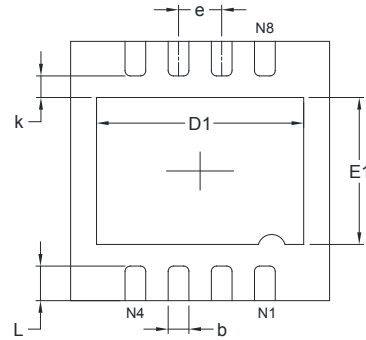

BOTTOM VIEW

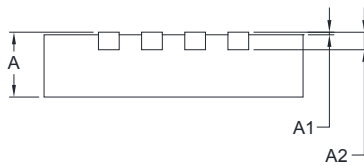

SIDE VIEW

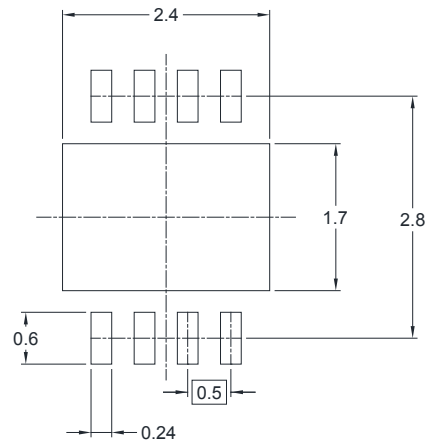

RECOMMENDED LAND PATTERN (Unit: mm)

Symbol	Dimensions In Millimeters		Dimensions In Inches	
	MIN	MAX	MIN	MAX
A	0.700	0.800	0.028	0.031
A1	0.000	0.050	0.000	0.002
A2	0.203 REF		0.008 REF	
D	2.900	3.100	0.114	0.122
D1	2.300	2.500	0.091	0.098
E	2.900	3.100	0.114	0.122
E1	1.600	1.800	0.063	0.071
k	0.200 MIN		0.008 MIN	
b	0.180	0.300	0.007	0.012
e	0.500 TYP		0.020 TYP	
L	0.300	0.500	0.012	0.020

TAPE AND REEL INFORMATION

REEL DIMENSIONS



TAPE DIMENSIONS



NOTE: The picture is only for reference. Please make the object as the standard.

KEY PARAMETER LIST OF TAPE AND REEL

Package Type	Reel Diameter	Reel Width W1 (mm)	A0 (mm)	B0 (mm)	K0 (mm)	P0 (mm)	P1 (mm)	P2 (mm)	W (mm)	Pin1 Quadrant
SOIC-8	13"	12.4	6.40	5.40	2.10	4.0	8.0	2.0	12.0	Q1
TDFN-3×3-8BL	13"	12.4	3.35	3.35	1.13	4.0	8.0	2.0	12.0	Q1

DD0001

# PACKAGE INFORMATION

## CARTON BOX DIMENSIONS



NOTE: The picture is only for reference. Please make the object as the standard.

## KEY PARAMETER LIST OF CARTON BOX

Reel Type	Length (mm)	Width (mm)	Height (mm)	Pizza/Carton
13"	386	280	370	5

DD0002