

REV.	ECN Number	Description	Drawn
1	CS21060033	初版发行	2021/05/18
2	E21120011	增加导柱尺寸	2021/12/11

100PIN:BB41-AOKT-1B-XHR

备注:

1. 塑胶材料: LCP-KD246BI, 黑色, 防火等级: UL 94V-0
2. 端子材料: 铜合金
3. 额定电压: 50V AC/DC for 1 minute
4. 接触阻抗: 50mΩ max. initial (不包括导体阻抗)
5. 耐电压: 500V AC for 1 minute
6. 绝缘阻抗: 100MΩ min.
7. 额定电流: 0.5A
8. 寿命: 30次 min
9. 插入力: 150gf max./pin, 拔出力: 8.5gf min./pin
10. 保持力: 250gf 最小/pin
11. 有害物质需符合Rohs2.0标准。
12. 尺寸符合ANSI Y14.5M-1994.

料号说明:

BB41-XXKT-1B-XHR

└─ K: 公母合高 11.25mm-12.25mm

└─ Pin数

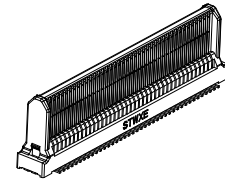
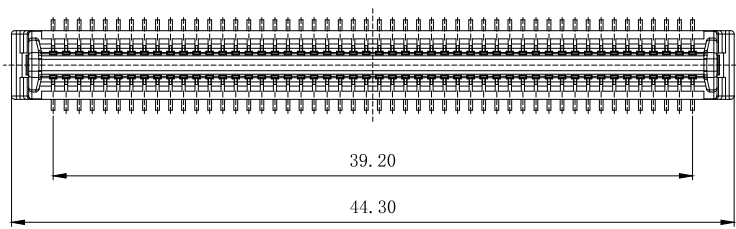

3D VIWE
(With out cover)

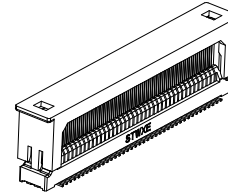

3D VIWE
(With cover)

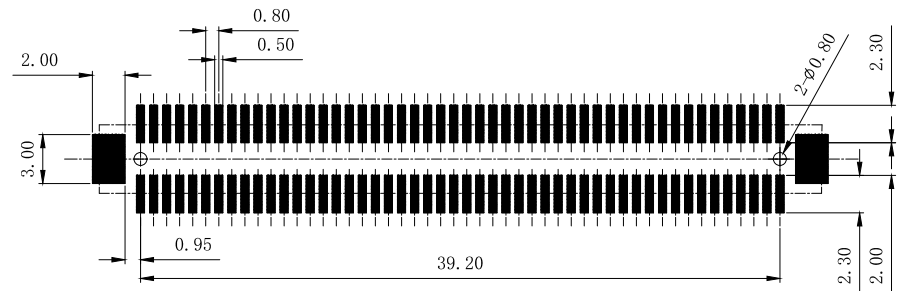
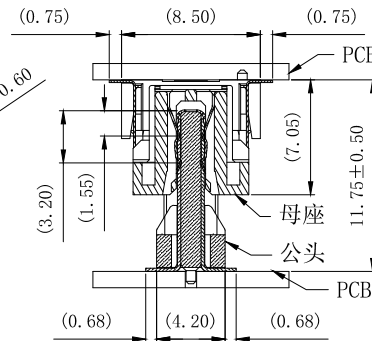
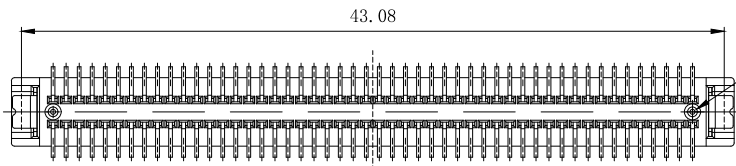
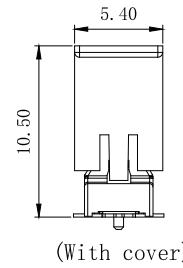
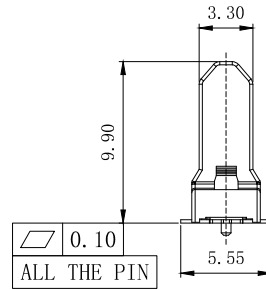
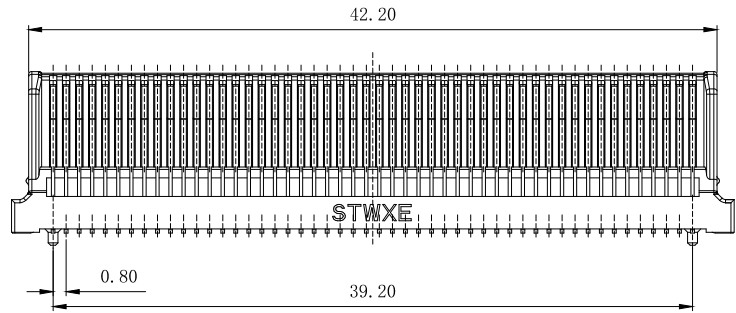

RECOMMENDED PCB LAYOUT
TOLERANCE: ±0.05mm

(公母合高)

X方向浮动量: ±0.5
Y方向浮动量: ±0.5
Z方向浮动量: ±0.5



ShenZhen ShenTai weixiang Electronics Co., Ltd

TOLERANCE UNLESS OTHERWISE SPECIFIED

X.X	±0.35	X.*	±5°
X.XX	±0.20	X.X*	±3°
X.XXX		X.XX*	±2°

SCALE 1:1

UNIT mm

SIZE A4



ORIGINAL DRAWN:
Qin Su

CHECK:
Wolfe Liu

APPROVE:
Wolfe Liu

DATE 2021/12/11

DATE 2021/12/11

DATE 2021/12/11

DWG. NO.

600-0000-0565

PARTS NO. (INTENDED USE)

BB41-XXKT-1B-XHR

TITLE

0.80mm Pitch 浮动BTB
客户图

REV.

2

SHEET

1/2

40PIN: BB41-40KT-1B-XHR

60PIN: BB41-60KT-1B-XHR

80PIN: BB41-80KT-1B-XHR

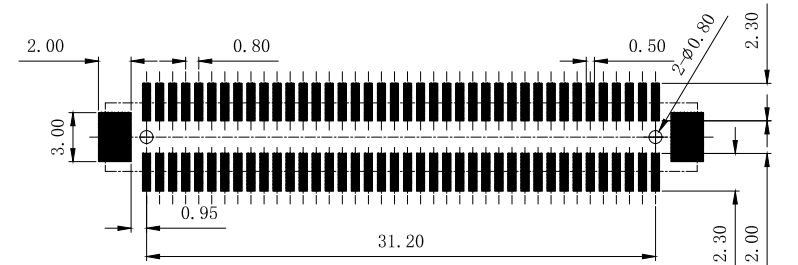
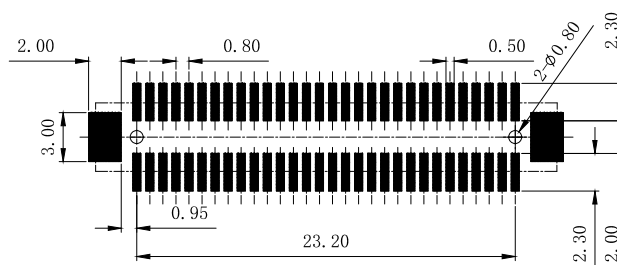
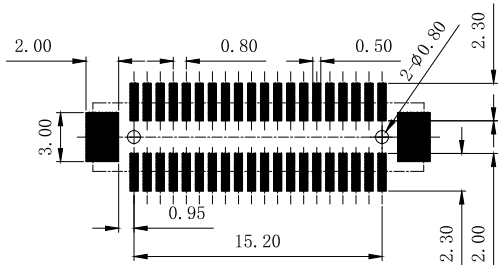
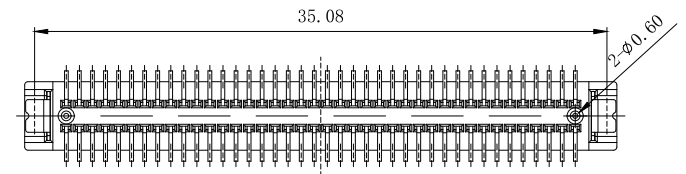
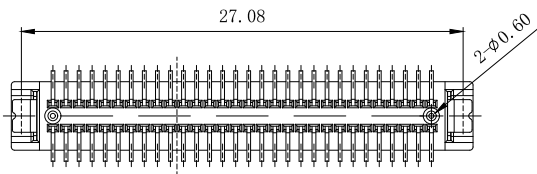
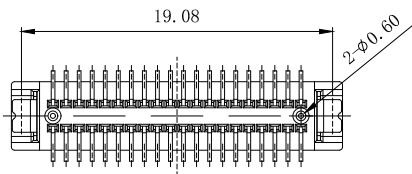
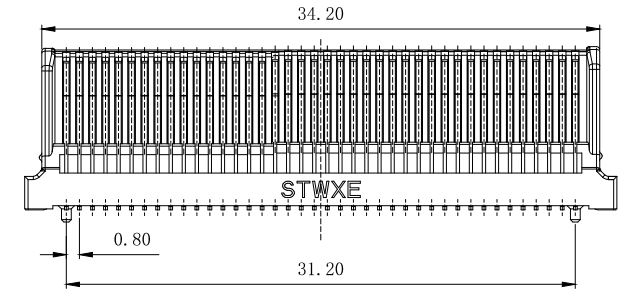
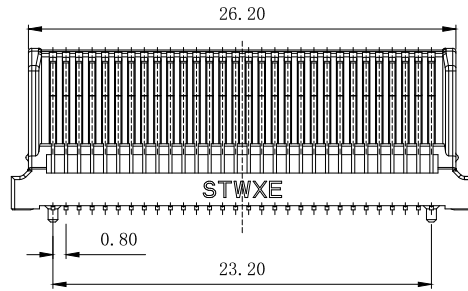
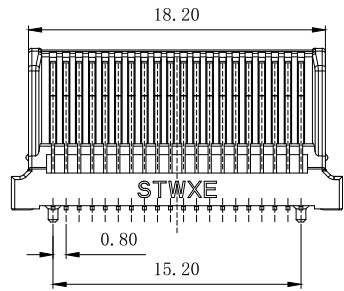
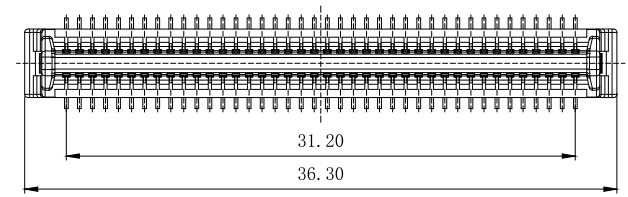
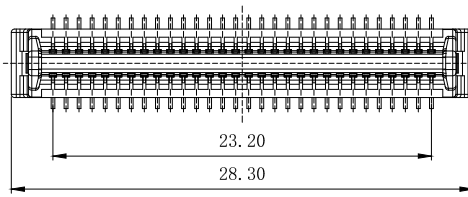
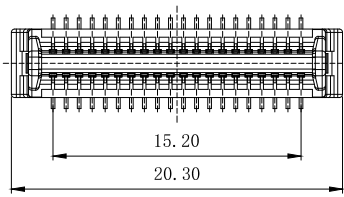

RECOMMENDED PCB LAYOUT
TOLERANCE: ±0.05mm

RECOMMENDED PCB LAYOUT
TOLERANCE: ±0.05mm

RECOMMENDED PCB LAYOUT
TOLERANCE: ±0.05mm



ShenZhen ShenTai weixiang Electronics Co., Ltd

TOLERANCE UNLESS OTHERWISE SPECIFIED

X.X	±0.35	X.*	±5°
X.XX	±0.20	X.X*	±3°
X.XXX		X.XX*	±2°

SCALE	1:1
UNIT	mm
SIZE	A4



ORIGINAL DRAWN:	Qin Su	DATE	2021/12/11
CHECK:	Wolfe Liu	DATE	2021/12/11
APPROVE:	Wolfe Liu	DATE	2021/12/11

DWG. NO.	600-0000-0565
PARTS NO. (INTENDED USE)	BB41-XXKT-1B-XHR

TITLE	0.80mm Pitch 浮动BTB 客户图
REV.	2
SHEET	2/2