

PART NUMBER	DESCRIPTION
CCS-47	Commercial Latching TRANSFER, DC-12GHz
CS-47	Elite Latching TRANSFER, DC-12GHz

The CCS-47/CS-47 is a long-life high performance transfer switch designed for use in 50 Ohms coaxial transmission lines operating over frequencies ranging from DC to 12 GHz. The switch is designed for minimum size compatible with Type N or TNC connector spacing. This switch is provided with a magnetic latching actuator which is particularly desirable in applications where actuator power consumption must be kept to an absolute minimum. The latching type actuator requires less switching current than the failsafe type. In the self-cutoff version, power is applied only for the very short duration (approximately 50 msec. max.) of the actuator transfer from one position of the other. This makes this type of actuator especially suitable for portable battery operated systems.



ENVIRONMENTAL AND PHYSICAL CHARACTERISTICS	
Operating Temperature	
Commercial Model, CCS-47	-25°C to 65°C
Elite Model, CS-47	-55°C to 85°C
Vibration (MIL-STD-202 Method 214, Condition D, non-operating)	10 g's RMS
Shock (MIL-STD-202 Method 213, Condition D, non-operating)	500 g's
Standard Actuator Life	3,000,000 cycles
Actuator Life w/ Additional Features	1,000,000 cycles
Connector Type	Type N or TNC
Humidity (Moisture Seal)	Available
Weight	6 oz. (170.1g) (max.)

ELECTRICAL CHARACTERISTICS	
Form Factor	TRANSFER, break before make
Frequency Range	
CCS-47	DC–12 GHz
CS-47	DC–12 GHz
Characteristic Impedance	50 Ohms
Operate Time	15 ms (max.)
Actuation Voltage Available	12 15 24 28 V
Actuation Current, max. @ ambient	160 130 80 60 mA

TYPICAL PERFORMANCE CHARACTERISTICS: N CONNECTOR OPTION (TNC CONNECTOR, 11GHz MAX.)					
Frequency	DC–1 GHz	1–4 GHz	4–8 GHz	8–10 GHz	10–12 GHz
Insertion Loss, dB, max.	0.3	0.4	0.5	0.5	0.5
Isolation, dB, min.	70	60	60	60	60
VSWR , max.	1.25:1	1.4:1	1.8:1	1.8:1	1.8:1

For maximum limits, please see charts on page 3-5

**PART NUMBERING SYSTEM**

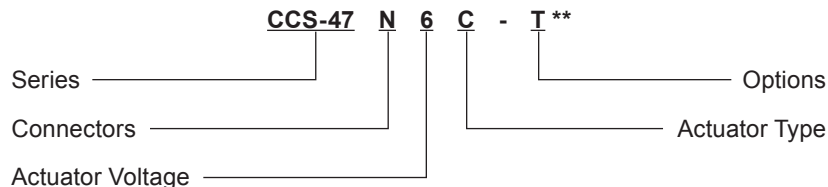

**Connector**  
N: Type N Female  
T: TNC Female

**Actuator Voltage**  
6: 28 Vdc Latching  
7: 15 Vdc Latching  
8: 12 Vdc Latching  
9: 24 Vdc Latching

**Actuator Type**  
0: Standard Contacts  
C: Indicator Contacts  
D: Self Cutoff Only  
E: Indicators and Self Cutoff

**Options**  
T: TTL Drivers with Diodes  
D: Transient Suppression Diodes  
R: Positive + Common  
M: Moisture Seal  
S: 9 Pin D-Sub Connector

\*\*SEE PARTS LIST ON PAGES 8-9

**For other options, contact factory.**

**SCHEMATICS AND MECHANICAL OUTLINE**

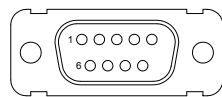
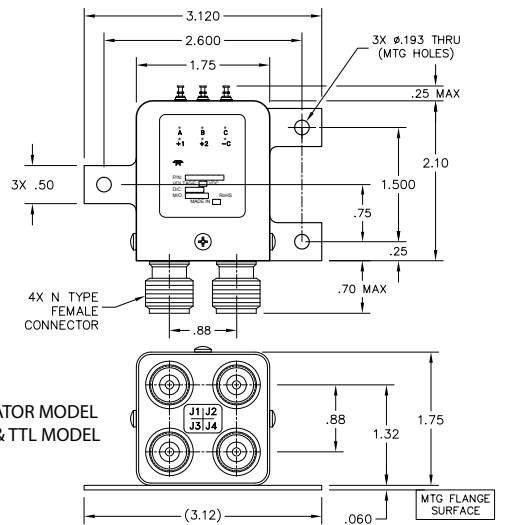
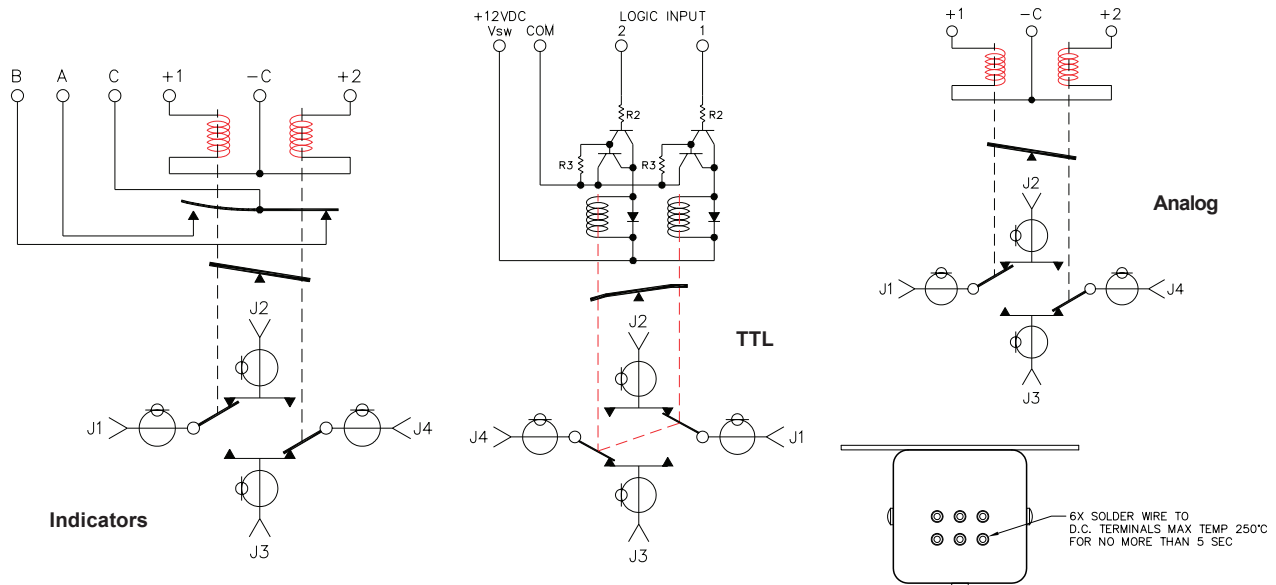

“-S OPTION” 9-PIN D-SUB CONNECTOR (EXAMPLE: CCS-47N60-S)

9 PIN D-SUB PINOUT FOR LATCHING TRANSFER				
Pin No.	OPTIONS			
	Basic	Indicators	TTL	Indicators & TTL
1	1	1		
2	2	2		
3	C	C	Common	Common
4			1	1
5			2	2
6			Vsw	Vsw
7		A		A
8		B		B
9		C		C

TRUTH TABLE (with TTL option)						
Logic Input		RF Path			Indicator (if applicable)	
1	2	1-2	1-3	2-4	3-4	A B
0	0	No Change			N/A	
1	0	Off	On	On	Off	A & C
0	1	On	Off	Off	On	B & C
1	1	Forbidden			N/A	

**TYPICAL NARROWBAND RF INSERTION LOSS PERFORMANCE CURVES**

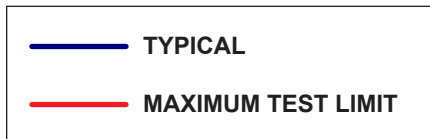
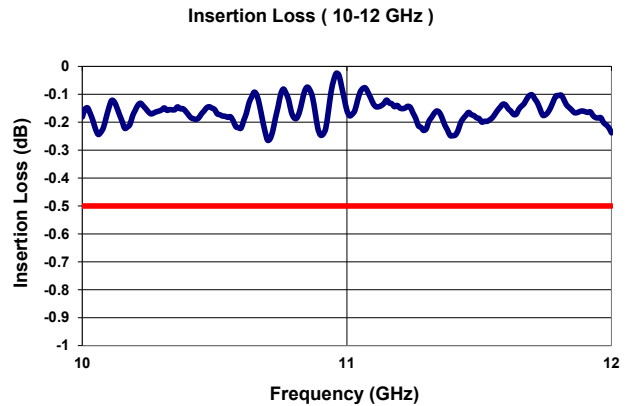
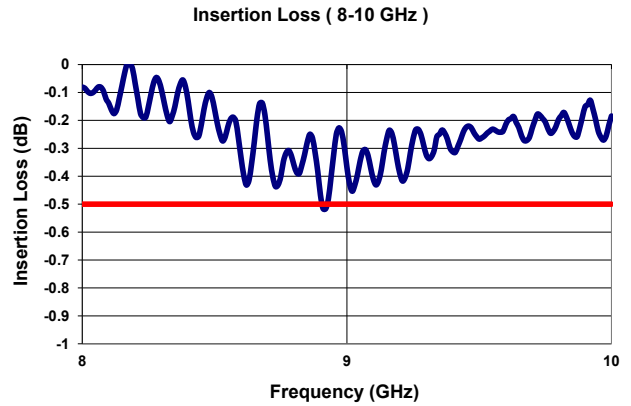
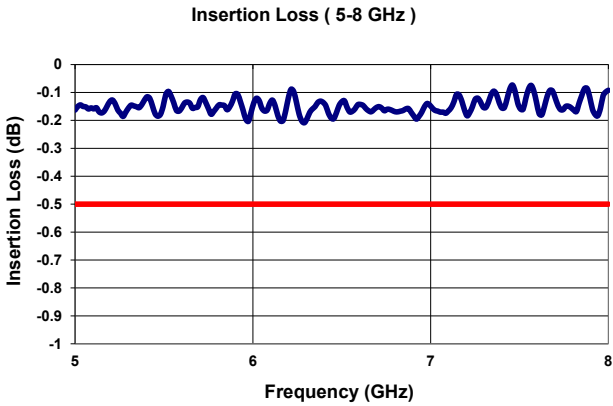
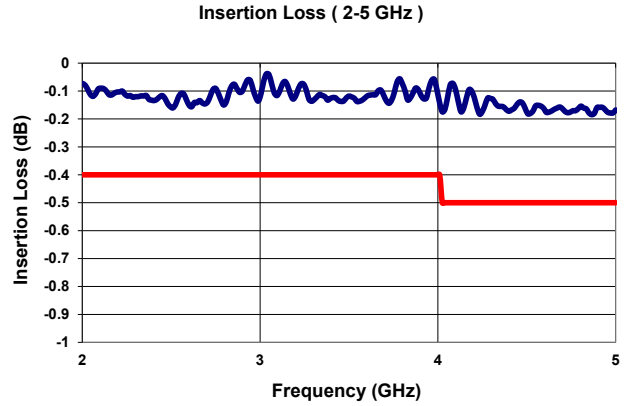
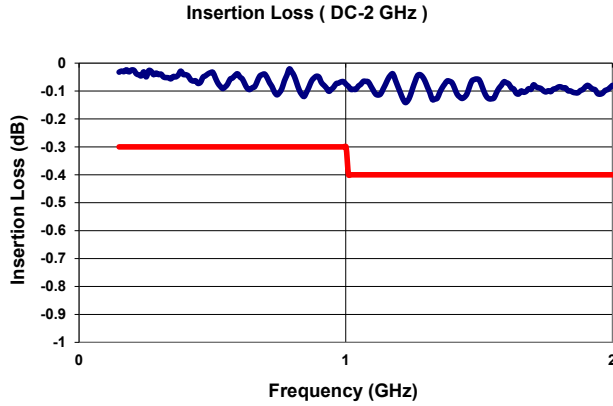

**TYPICAL NARROWBAND RF ISOLATION PERFORMANCE CURVES**

Isolation ( DC-2 GHz )

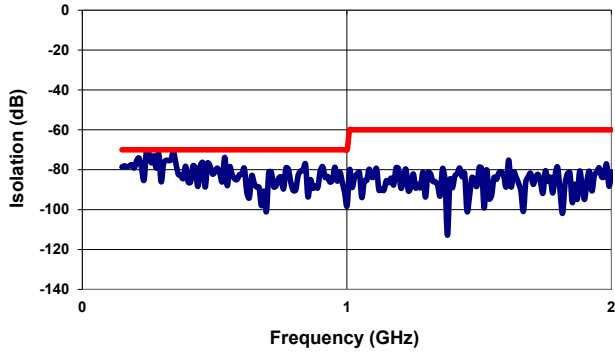

Isolation ( 2-5 GHz )

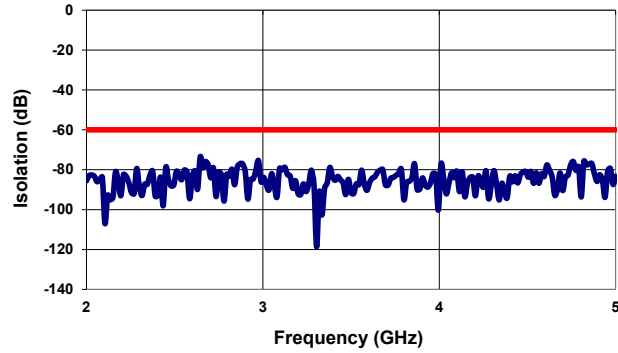

Isolation ( 5-8 GHz )

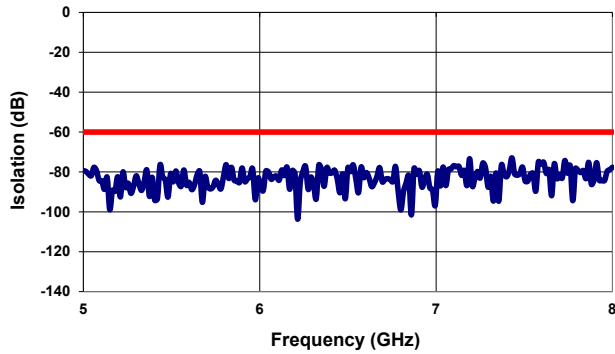

Isolation ( 8-10 GHz )

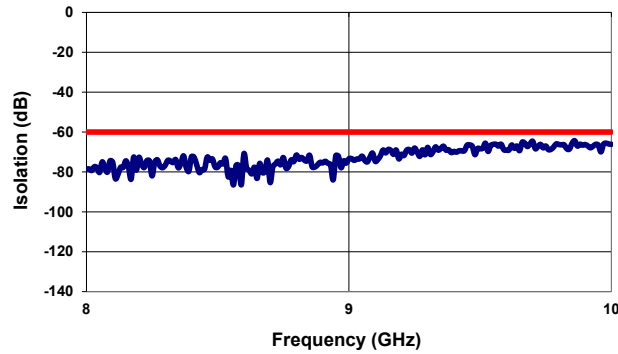

Isolation ( 10-12 GHz )

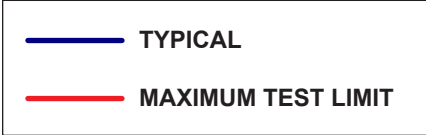
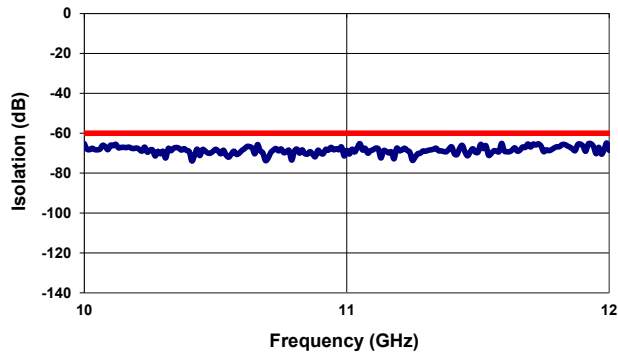

**TYPICAL NARROWBAND RF VSWR PERFORMANCE CURVES**

**VSWR ( DC-2 GHz )**

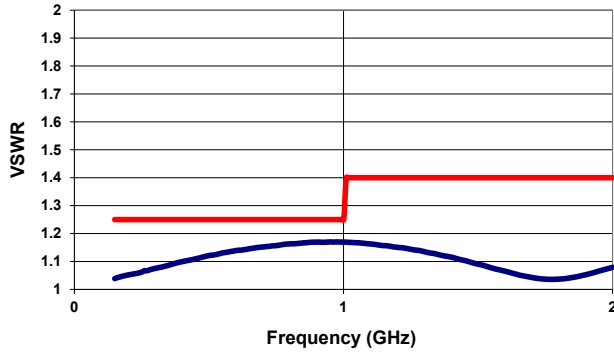

**VSWR ( 2-5 GHz )**

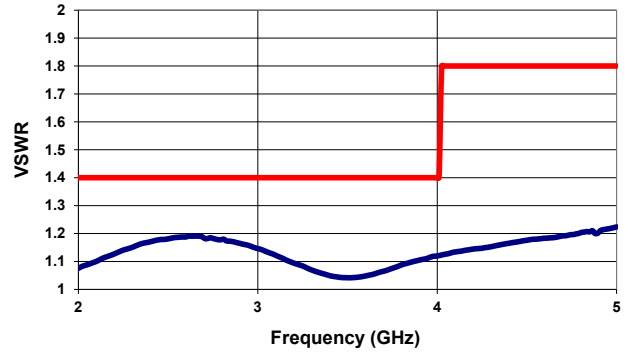

**VSWR ( 5-8 GHz )**

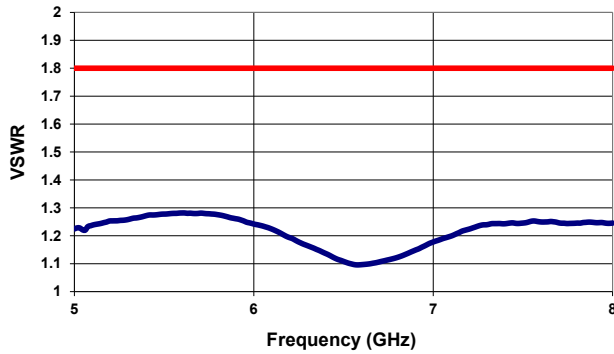

**VSWR ( 8-10 GHz )**

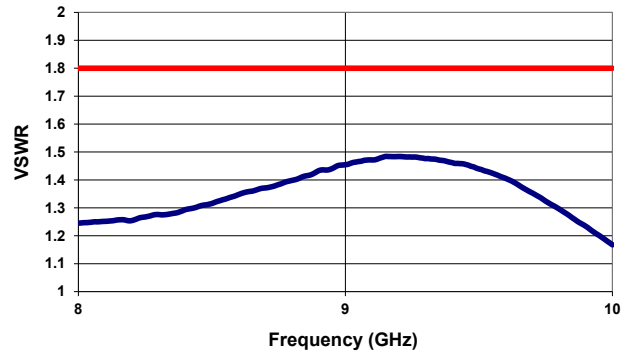

**VSWR ( 10-12 GHz )**

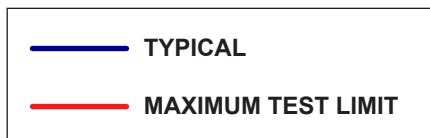
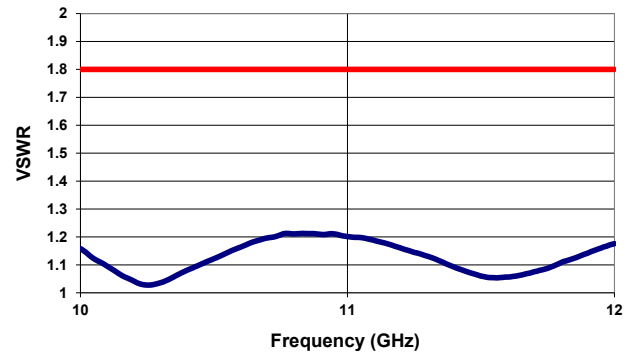

**TYPICAL POWER PERFORMANCE CURVE**

# Power Handling vs. Frequency

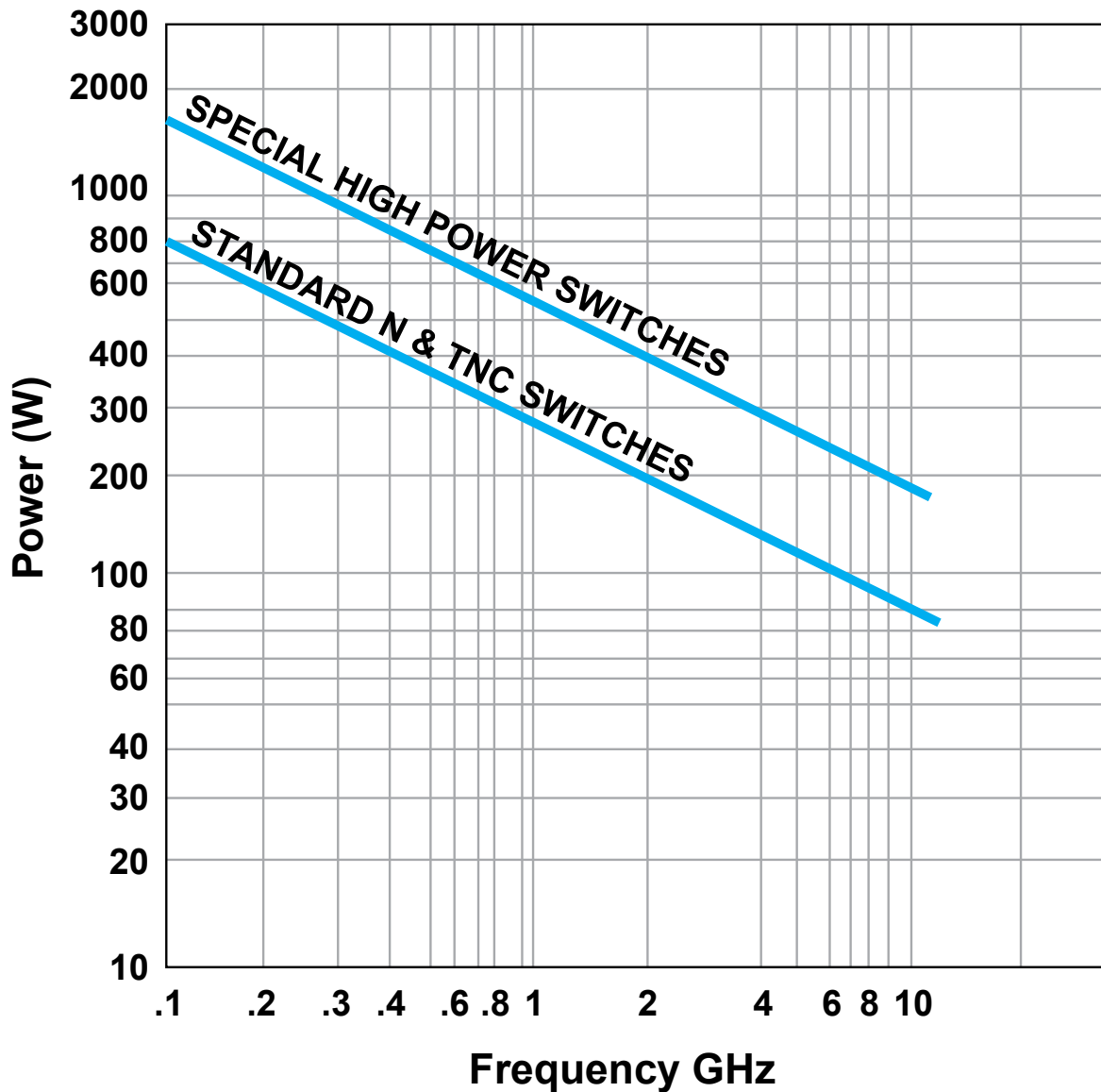

Estimates based on the following reference conditions:

- Ambient temperature of 40°C or less
- Sea level operation
- Load VSWR of 1.20:1 maximum
- No high-power (hot) switching

Please contact Teledyne Coax Switches for derating factors when applications do not meet the foregoing reference conditions.

**GLOSSARY**

**Actuator**

An actuator is the electromechanical mechanism that transfers the RF contacts from one position to another upon DC command.

**Arc Suppression Diode**

A diode is connected in parallel with the coil. This diode limits the “reverse EMF spike” generated when the coil de-energizes to 0.7 volts. The diode cathode is connected to the positive side of the coil and the anode is connected to the negative side.

**Date Code**

All switches are marked with either a unique serial number or a date code. Date codes are in accordance with MIL-STD-1285 Paragraph 5.2.5 and consist of four digits. The first two digits define the year and the last two digits define the week of the year (YYWW). Thus, 1032 identifies switches that passed through final inspection during the 32nd week of 2010.

**Latching**

A latching switch remains in the selected position whether or not voltage is maintained. This can be accomplished with either a magnetic or mechanical latching mechanism.

**Indicator**

Indicators tell the system which position the switch is in. Other names for indicators are telemetry contacts or tellback circuit. Indicators are usually a set of internally mounted DC contacts linked to the actuator. They can be wired to digital input lines, status lights, or interlocks. Unless otherwise specified, the maximum indicator contact rating is 30 Vdc, 50 mA, or 1.5 Watts into a resistive load.

**Isolation**

Isolation is the measure of the power level at the output connector of an unconnected RF channel as referenced to the power at the input connector. It is specified in dB below the input power level.

**Self-Cutoff**

The self-cutoff option disables the actuator current on completion of actuation. Either a series contact (linked to the actuator) or an IC driver circuit provides the current cutoff. This option results in minimum power consumption by the RF switch. Cutthroat is another name used in the industry for this option. Pulse latching is a term used to describe a switch without this feature.

**TRANSFER Switch**

A four-port switch consisting of two independent pairs of RF paths. These pairs are actuated simultaneously. This actuation is similar to that of a double-pole double-throw switch.

**Switching Time**

Switching time is the total interval beginning with the arrival of the leading edge of the command pulse at the switch DC

input and ending with the completion of the switch transfer, including contact bounce. It consists of three parts: (1) inductive delay in the coil, (2) transfer time of the physical movement of the contacts, and (3) the bounce time of the RF contacts.

**TTL Switch Driver Option**

As a special option, switch drivers can be provided for both failsafe and latching switches, which are compatible with industry-standard low-power Schottky TTL circuits.

**Performance Parameters vs Frequency**

Generally speaking, the RF performance of coaxial switches is frequency dependent. With increasing frequency, VSWR and insertion loss increase while isolation decreases. All data sheets specify these three parameters as “worst case” at the highest operating frequency. If the switch is to be used over a narrow frequency band, better performance can be achieved.

**Actuator Current vs Temperature**

The resistance of the actuator coil varies as a function of temperature. There is an inverse relationship between the operating temperature of the switch and the actuator drive current. For switches operating at 28 VDC, the approximate actuator drive current at temperature, T, can be calculated using the equation:

$$I_T = \frac{I_A}{[1 + .00385 (T-20)]}$$

Where:

$I_T$  = Actuator current at temperature, T

$I_A$  = Room temperature actuator current – see data sheet

T = Temperature of interest in °C

**Magnetic Sensitivity**

An electro-mechanical switch can be sensitive to ferrous materials and external magnetic fields. Neighboring ferrous materials should be permitted no closer than 0.5 inches and adjacent external magnetic fields should be limited to a flux density of less than 5 Gauss.

**SPECIAL FEATURE**

**Switching High-Power or Highly Sensitive Signals**

Ensure the most linear response with the best galvanically matched contact system in the industry. Extremely low passive intermodulation is standard on all of our switches.

Carrier Frequency 1	Carrier Frequency 2	PIM 3rd Order Frequency	PIM 5th Order Frequency
870 MHz	893 MHz	847 MHz	824 MHz

	3rd Order Intermodulation	5th Order Intermodulation
Transfer	–103 dBm	–123 dBm
	–146 dBc	–165 dBc

**Series CCS-47/CS-47**  
**High Power DC-12 GHz**  
**Latching TRANSFER Coaxial Switch**



**LATCHING CCS-47N/CS-47N • CCS-47T/CS-47T PART NUMBER LIST**

	PART No.		PART No.		PART No.		PART No.
1	CCS-47NXC	43	CCS-47NX0	85	CS-47NXD-MS	127	CCS-47TXC-DM
2	CCS-47NXC-D	44	CCS-47NX0-D	86	CS-47NXD-R	128	CCS-47TXC-DMS
3	CCS-47NXC-DM	45	CCS-47NX0-DM	87	CS-47NXD-RM	129	CCS-47TXC-DR
4	CCS-47NXC-DMS	46	CCS-47NX0-DMS	88	CS-47NXD-RMS	130	CCS-47TXC-DRM
5	CCS-47NXC-DR	47	CCS-47NX0-DR	89	CS-47NXD-RS	131	CCS-47TXC-DRMS
6	CCS-47NXC-DRM	48	CCS-47NX0-DRM	90	CS-47NXD-S	132	CCS-47TXC-DRS
7	CCS-47NXC-DRMS	49	CCS-47NX0-DRMS	91	CS-47NXD-T	133	CCS-47TXC-DS
8	CCS-47NXC-DRS	50	CCS-47NX0-DRS	92	CS-47NXD-TM	134	CCS-47TXC-M
9	CCS-47NXC-DS	51	CCS-47NX0-DS	93	CS-47NXD-TMS	135	CCS-47TXC-MS
10	CCS-47NXC-M	52	CCS-47NX0-M	94	CS-47NXE	136	CCS-47TXC-R
11	CCS-47NXC-MS	53	CCS-47NX0-MS	95	CS-47NXE-M	137	CCS-47TXC-RM
12	CCS-47NXC-R	54	CCS-47NX0-R	96	CS-47NXE-MS	138	CCS-47TXC-RMS
13	CCS-47NXC-RM	55	CCS-47NX0-RM	97	CS-47NXE-R	139	CCS-47TXC-RS
14	CCS-47NXC-RMS	56	CCS-47NX0-RMS	98	CS-47NXE-RM	140	CCS-47TXC-S
15	CCS-47NXC-RS	57	CCS-47NX0-RS	99	CS-47NXE-RMS	141	CCS-47TXC-T
16	CCS-47NXC-S	58	CCS-47NX0-S	100	CS-47NXE-RS	142	CCS-47TXC-TM
17	CCS-47NXC-T	59	CCS-47NX0-T	101	CS-47NXE-S	143	CCS-47TXC-TMS
18	CCS-47NXC-TM	60	CCS-47NX0-TM	102	CS-47NXE-T	144	CCS-47TXC-TS
19	CCS-47NXC-TMS	61	CCS-47NX0-TMS	103	CS-47NXE-TM	145	CCS-47TXD
20	CCS-47NXC-TS	62	CCS-47NX0-TS	104	CS-47NXE-TMS	146	CCS-47TXD-M
21	CCS-47NXD	63	CS-47NXC	105	CS-47NX0	147	CCS-47TXD-MS
22	CCS-47NXD-M	64	CS-47NXC-D	106	CS-47NX0-D	148	CCS-47TXD-R
23	CCS-47NXD-MS	65	CS-47NXC-DM	107	CS-47NX0-DM	149	CCS-47TXD-RM
24	CCS-47NXD-R	66	CS-47NXC-DMS	108	CS-47NX0-DMS	150	CCS-47TXD-RMS
25	CCS-47NXD-RM	67	CS-47NXC-DR	109	CS-47NX0-DR	151	CCS-47TXD-RS
26	CCS-47NXD-RMS	68	CS-47NXC-DRM	110	CS-47NX0-DRM	152	CCS-47TXD-S
27	CCS-47NXD-RS	69	CS-47NXC-DRMS	111	CS-47NX0-DRMS	153	CCS-47TXD-T
28	CCS-47NXD-S	70	CS-47NXC-DRS	112	CS-47NX0-DRS	154	CCS-47TXD-TM
29	CCS-47NXD-T	71	CS-47NXC-DS	113	CS-47NX0-DS	155	CCS-47TXD-TMS
30	CCS-47NXD-TM	72	CS-47NXC-M	114	CS-47NX0-M	156	CCS-47TXE
31	CCS-47NXD-TMS	73	CS-47NXC-MS	115	CS-47NX0-MS	157	CCS-47TXE-M
32	CCS-47NXE	74	CS-47NXC-R	116	CS-47NX0-R	158	CCS-47TXE-MS
33	CCS-47NXE-M	75	CS-47NXC-RM	117	CS-47NX0-RM	159	CCS-47TXE-R
34	CCS-47NXE-MS	76	CS-47NXC-RMS	118	CS-47NX0-RMS	160	CCS-47TXE-RM
35	CCS-47NXE-R	77	CS-47NXC-RS	119	CS-47NX0-RS	161	CCS-47TXE-RMS
36	CCS-47NXE-RM	78	CS-47NXC-S	120	CS-47NX0-S	162	CCS-47TXE-RS
37	CCS-47NXE-RMS	79	CS-47NXC-T	121	CS-47NX0-T	163	CCS-47TXE-S
38	CCS-47NXE-RS	80	CS-47NXC-TM	122	CS-47NX0-TM	164	CCS-47TXE-T
39	CCS-47NXE-S	81	CS-47NXC-TMS	123	CS-47NX0-TMS	165	CCS-47TXE-TM
40	CCS-47NXE-T	82	CS-47NXC-TS	124	CS-47NX0-TS	166	CCS-47TXE-TMS
41	CCS-47NXE-TM	83	CS-47NXD	125	CCS-47TXC	167	CCS-47TX0
42	CCS-47NXE-TMS	84	CS-47NXD-M	126	CCS-47TXC-D	168	CCS-47TX0-D

\* X = 6 (28Vdc), 7 (15Vdc), 8 (12Vdc) and 9 (24Vdc)



**LATCHING CCS-47N/CS-47N • CCS-47T/CS-47T PART NUMBER LIST**

	PART No.		PART No.
169	CCS-47TX0-DM	211	CS-47TXD-RM
170	CCS-47TX0-DMS	212	CS-47TXD-RMS
171	CCS-47TX0-DR	213	CS-47TXD-RS
172	CCS-47TX0-DRM	214	CS-47TXD-S
173	CCS-47TX0-DRMS	215	CS-47TXD-T
174	CCS-47TX0-DRS	216	CS-47TXD-TM
175	CCS-47TX0-DS	217	CS-47TXD-TMS
176	CCS-47TX0-M	218	CS-47TXE
177	CCS-47TX0-MS	219	CS-47TXE-M
178	CCS-47TX0-R	220	CS-47TXE-MS
179	CCS-47TX0-RM	221	CS-47TXE-R
180	CCS-47TX0-RMS	222	CS-47TXE-RM
181	CCS-47TX0-RS	223	CS-47TXE-RMS
182	CCS-47TX0-S	224	CS-47TXE-RS
183	CCS-47TX0-T	225	CS-47TXE-S
184	CCS-47TX0-TM	226	CS-47TXE-T
185	CCS-47TX0-TMS	227	CS-47TXE-TM
186	CCS-47TX0-TS	228	CS-47TXE-TMS
187	CS-47TXC	229	CS-47TX0
188	CS-47TXC-D	230	CS-47TX0-D
189	CS-47TXC-DM	231	CS-47TX0-DM
190	CS-47TXC-DMS	232	CS-47TX0-DMS
191	CS-47TXC-DR	233	CS-47TX0-DR
192	CS-47TXC-DRM	234	CS-47TX0-DRM
193	CS-47TXC-DRMS	235	CS-47TX0-DRMS
194	CS-47TXC-DRS	236	CS-47TX0-DRS
195	CS-47TXC-DS	237	CS-47TX0-DS
196	CS-47TXC-M	238	CS-47TX0-M
197	CS-47TXC-MS	239	CS-47TX0-MS
198	CS-47TXC-R	240	CS-47TX0-R
199	CS-47TXC-RM	241	CS-47TX0-RM
200	CS-47TXC-RMS	242	CS-47TX0-RMS
201	CS-47TXC-RS	243	CS-47TX0-RS
202	CS-47TXC-S	244	CS-47TX0-S
203	CS-47TXC-T	245	CS-47TX0-T
204	CS-47TXC-TM	246	CS-47TX0-TM
205	CS-47TXC-TMS	247	CS-47TX0-TMS
206	CS-47TXC-TS	248	CS-47TX0-TS
207	CS-47TXD		
208	CS-47TXD-M		
209	CS-47TXD-MS		
210	CS-47TXD-R		

\* X = 6 (28Vdc), 7 (15Vdc), 8 (12Vdc) and 9 (24Vdc)