

PDFNWB3.3×3.3-8L Plastic-Encapsulate MOSFETS

CJAB55N03S N-Channel Power MOSFET

$V_{(BR)DSS}$	$R_{DS(on)TYP}$	I_D
30V	3.8mΩ@10V	55A
	5.9mΩ@4.5V	

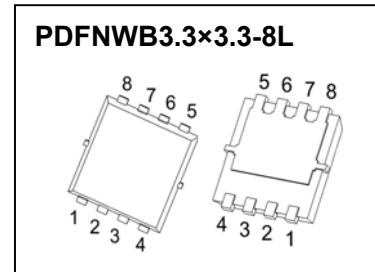

DESCRIPTION

The CJAB55N03S uses advanced trench technology and design to provide excellent $R_{DS(ON)}$ with low gate charge. It can be used in a wide variety of applications

FEATURES

- Battery switch
- Load switch
- High density cell design for ultra low $R_{DS(ON)}$
- Fully characterized avalanche voltage and current
- Good stability and uniformity with high E_{AS}
- Excellent package for good heat dissipation

APPLICATIONS

- SMPS and general purpose applications
- Hard switched and high frequency circuits
- Uninterruptible Power Supply

MARKING

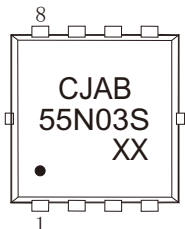

CJAB55N03S = Part No.
 Solid dot = Pin1 indicator
 XX = Code

EQUIVALENT CIRCUIT

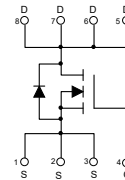

ABSOLUTE MAXIMUM RATINGS ($T_a=25^{\circ}C$ unless otherwise noted)

Parameter	Symbol	Value	Unit
Drain-Source Voltage	V_{DS}	30	V
Gate-Source Voltage	V_{GS}	±20	
Continuous Drain Current	I_D ①	55	A
Pulsed Drain Current	I_{DM} ②	220	
Maximum Power Dissipation	P_D ⑥	40	W
Single Pulsed Avalanche Energy	E_{AS} ③	120	mJ
Thermal Resistance from Junction to Case	$R_{\theta JC}$ ⑥	3.1	°C/W
Thermal Resistance from Junction to Ambient	$R_{\theta JA}$ ⑥	83.3	°C/W
Operating Junction and Storage Temperature Range	T_J, T_{stg}	-55~+150	°C

MOSFET ELECTRICAL CHARACTERISTICS

$T_a=25^\circ\text{C}$ unless otherwise specified

Parameter	Symbol	Test Condition	Min	Typ	Max	Unit
Off characteristics						
Drain-source breakdown voltage	$V_{(BR)DSS}$	$V_{GS} = 0V, I_D = 250\mu A$	30			V
Zero gate voltage drain current	I_{DSS}	$V_{DS} = 24V, V_{GS} = 0V$			1.0	μA
Gate-body leakage current	I_{GSS}	$V_{DS} = 0V, V_{GS} = \pm 20V$			± 100	nA
On characteristics ^④						
Gate-threshold voltage	$V_{GS(th)}$	$V_{DS} = V_{GS}, I_D = 250\mu A$	1.0	1.7	2.5	V
Static drain-source on-state resistance	$R_{DS(on)}$	$V_{GS} = 10V, I_D = 20A$		3.8	5.5	m Ω
		$V_{GS} = 4.5V, I_D = 20A$		5.9	9.5	m Ω
Forward transconductance	g_{fs}	$V_{DS} = 10V, I_D = 20A$		10		S
Dynamic characteristics ^{④ ⑤}						
Input capacitance	C_{iss}	$V_{DS} = 15V, V_{GS} = 0V,$ $f = 1MHz$		2800		pF
Output capacitance	C_{oss}			295		
Reverse transfer capacitance	C_{rss}			240		
Gate resistance	R_g	$f = 1MHz$		2.7		Ω
Switching characteristics ^{④ ⑤}						
Total gate charge	Q_g	$V_{GS} = 10V,$ $V_{DS} = 25V, I_D = 14A$		50		nC
Gate-source charge	Q_{gs}			6.2		
Gate-drain charge	Q_{gd}			11		
Turn-on delay time	$t_{d(on)}$	$V_{DS} = 15V, R_L = 0.75\Omega,$ $V_{GS} = 10V, R_G = 3\Omega$		12		ns
Turn-on rise time	t_r			36		
Turn-off delay time	$t_{d(off)}$			49		
Turn-off fall time	t_f			12		
Drain-Source Diode Characteristics						
Drain-source diode forward voltage	V_{SD} ^④	$V_{GS} = 0V, I_S = 20A$			1.2	V
Continuous drain-source diode forward current	I_S ^①				55	A
Pulsed drain-source diode forward current	I_{SM} ^②				220	A

Notes:

1. $V_{DS} < V_{(BR)DSS}$ Limited only by maximum temperature allowed.

2. $P_W \leq 10\mu s$, Duty cycle $\leq 1\%$.

3. EAS condition: $V_{DD} = 20V, V_{GS} = 10V, L = 0.5mH, R_g = 25\Omega$ Starting $T_J = 25^\circ\text{C}$.

4. Pulse Test : Pulse Width $\leq 300\mu s$, duty cycle $\leq 2\%$.

5. Guaranteed by design, not subject to production.

6. The value of $R_{\theta JA}$ is measured with the device mounted on 1 in 2 FR-4 board with 2oz. Copper, in a still air environment with $T_a = 25^\circ\text{C}$.

Typical Characteristics

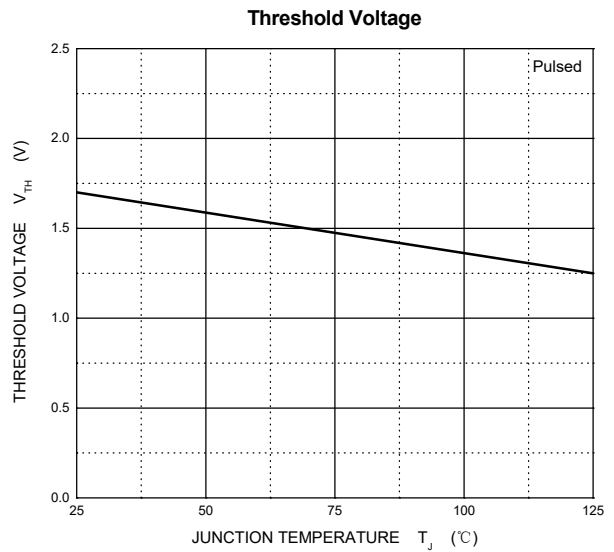
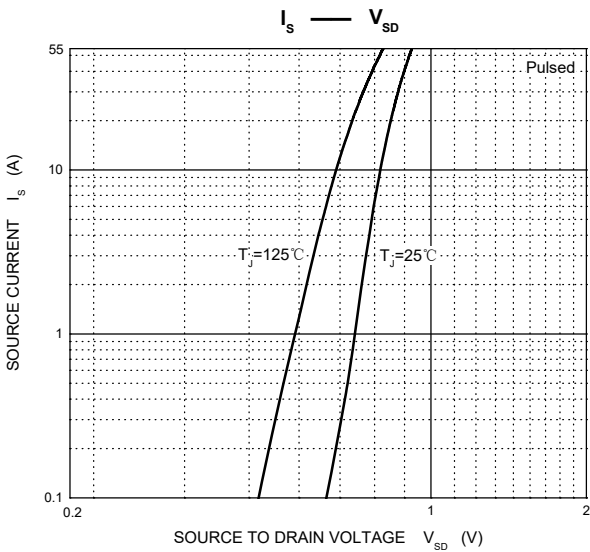
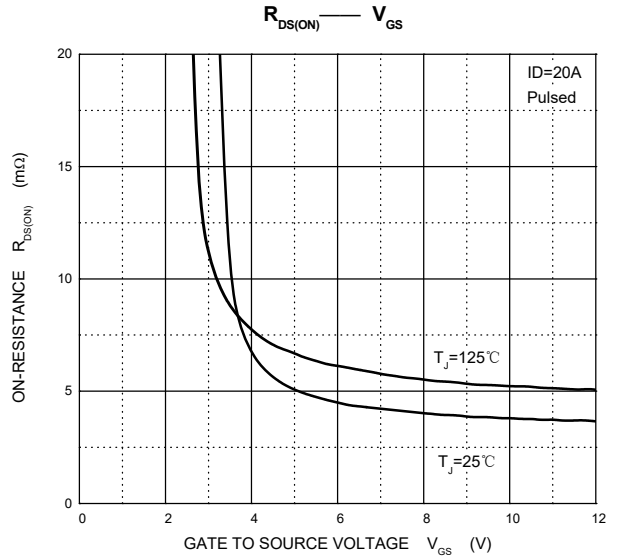
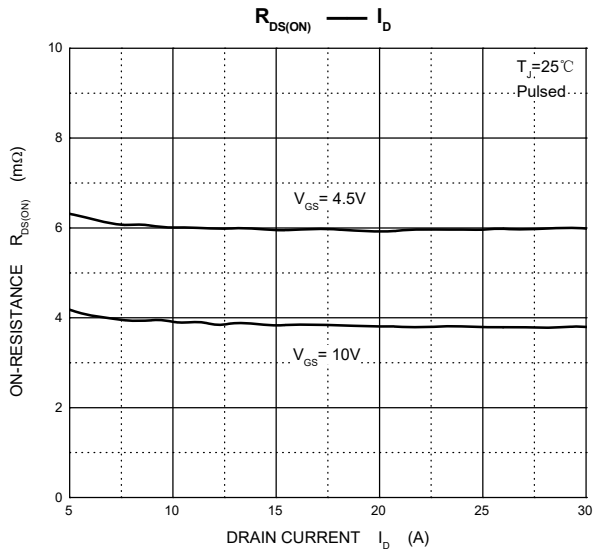
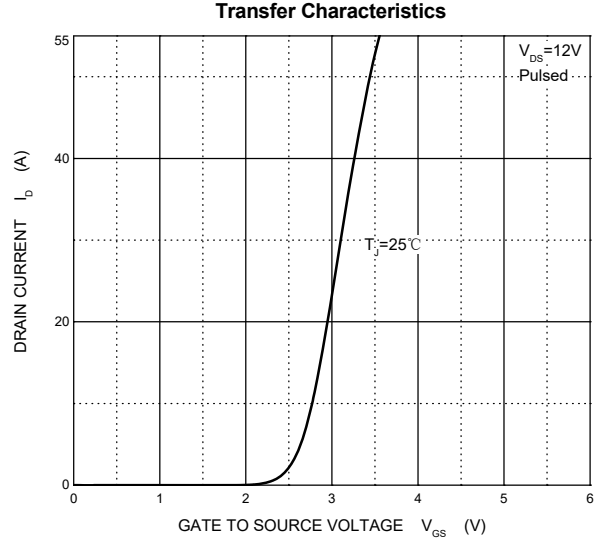
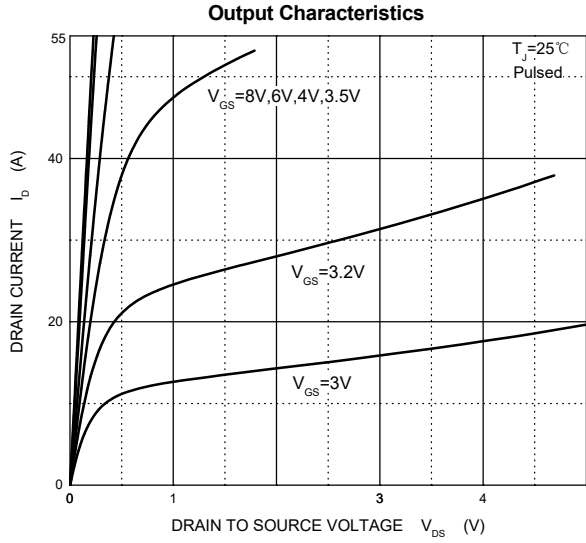

Typical Characteristics

Capacitances

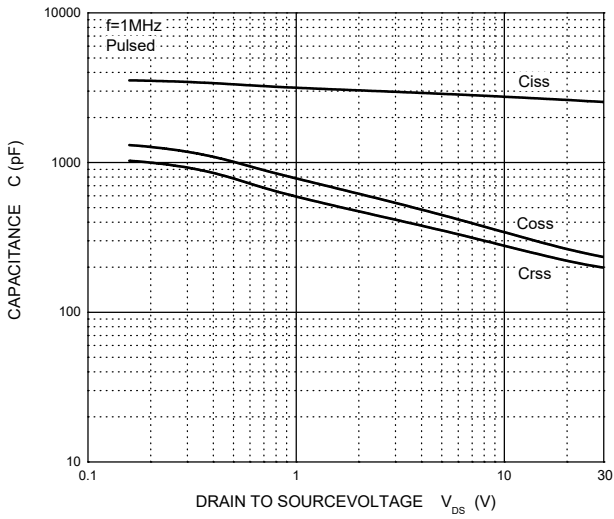

Gate Charge

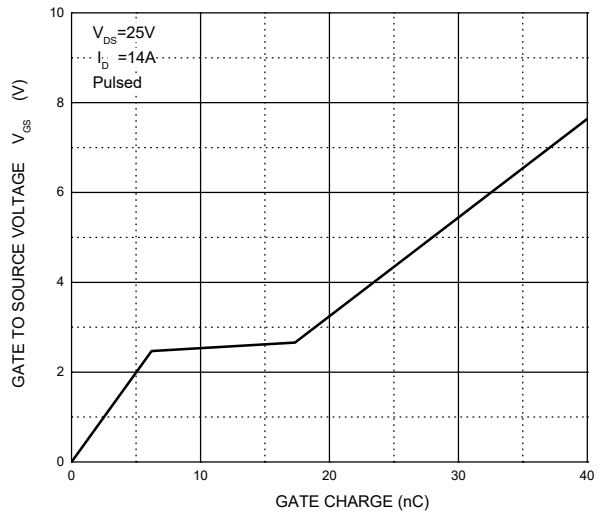

NORMALIZED TRANSIENT THERMAL IMPEDANCE

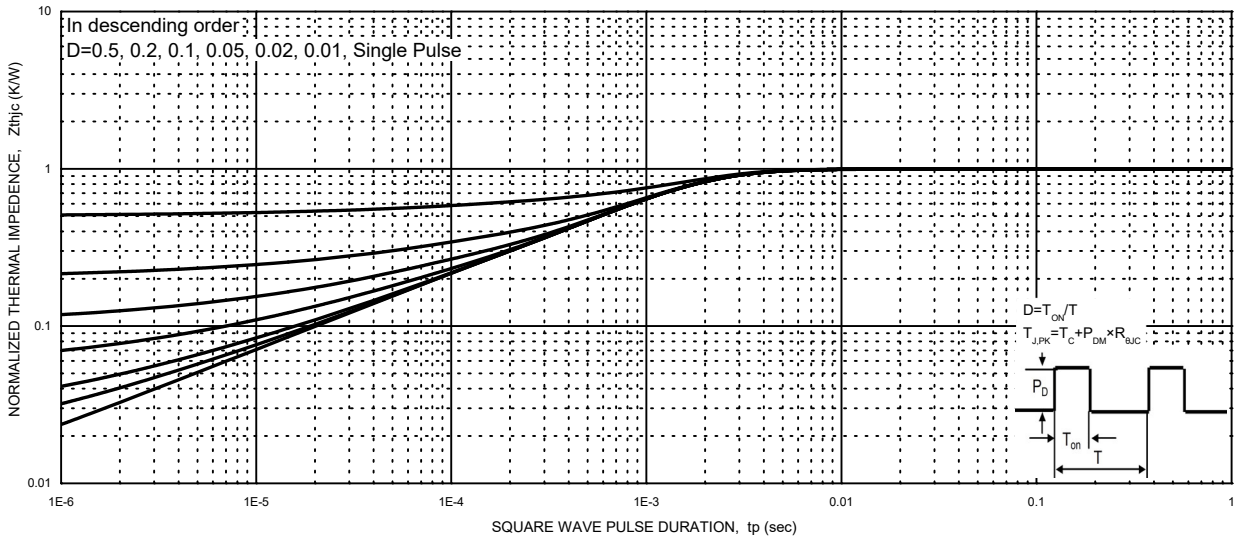

MAXIMUM FORWARD BIASED SAFE OPERATING AREA

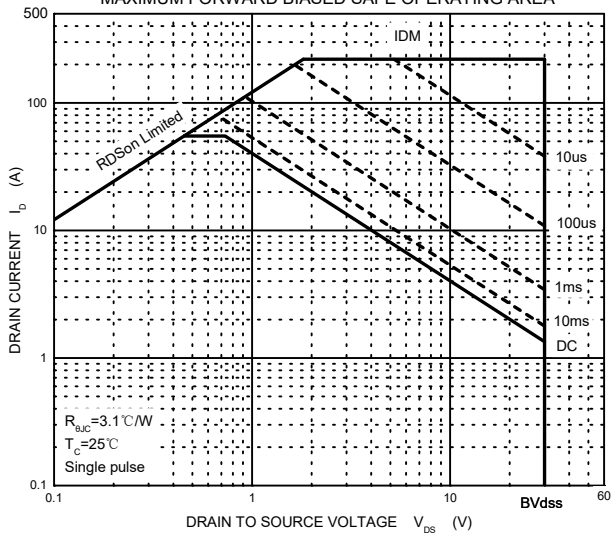

PDFNWB3.3x3.3-8L Package Outline Dimensions

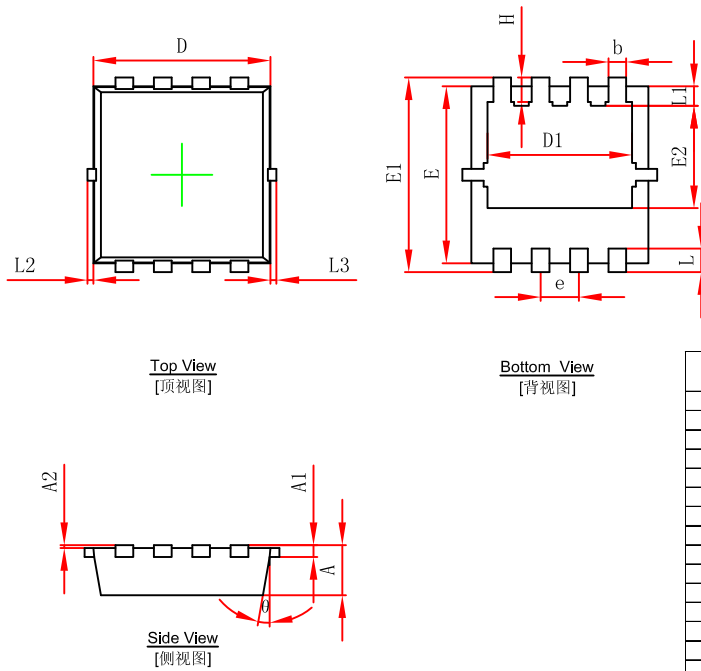

Symbol	Dimensions In Millimeters		Dimensions In Inches	
	Min.	Max.	Min.	Max.
A	0.650	0.850	0.026	0.033
A1	0.152 REF.		0.006 REF.	
A2	0-0.05		0-0.002	
D	2.900	3.100	0.114	0.122
D1	2.300	2.600	0.091	0.102
E	2.900	3.100	0.114	0.122
E1	3.150	3.450	0.124	0.136
E2	1.535	1.935	0.060	0.076
b	0.200	0.400	0.008	0.016
e	0.550	0.750	0.022	0.030
L	0.300	0.500	0.012	0.020
L1	0.180	0.480	0.007	0.019
L2	0-0.100		0-0.004	
L3	0-0.100		0-0.004	
H	0.315	0.515	0.012	0.020
θ	9°	13°	9°	13°

PDFNWB3.3x3.3-8L Suggested Pad Layout

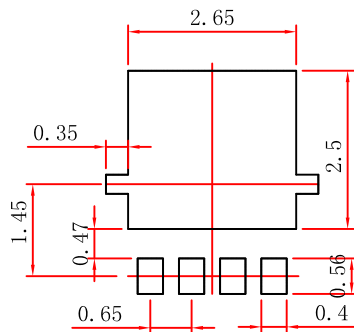

Note:

1. Controlling dimension: in millimeters.
2. General tolerance: $\pm 0.05\text{mm}$.
3. The pad layout is for reference purposes only.

NOTICE

JSCJ reserves the right to make modifications, enhancements, improvements, corrections or other changes without further notice to any product herein. JSCJ does not assume any liability arising out of the application or use of any product described herein.

PDFNWB3.3×3.3-8L Tape and Reel

PDFNWB3.3×3.3-8L Embossed Carrier Tape

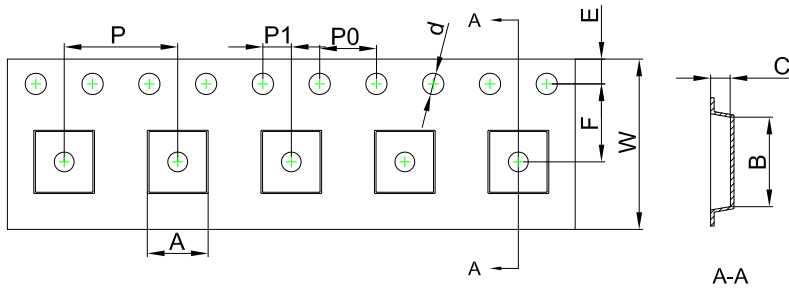

Packaging Description:

PDFNWB3.3×3.3-8L parts are shipped in tape. The carrier tape is made from a dissipative (carbon filled) polycarbonate resin. The cover tape is a multilayer film (Heat Activated Adhesive in nature) primarily composed of polyester film, adhesive layer, sealant, and anti-static sprayed agent. These reeled parts in standard option are shipped with 5,000 units per 13" or 33.0 cm diameter reel. The reels are clear in color and is made of polystyrene plastic (anti-static coated).

Dimensions are in millimeter										
Pkg type	A	B	C	d	E	F	P0	P	P1	W
PDFNWB3.3×3.3-8L	3.55	3.55	1.10	Ø1.50	1.75	5.50	4.00	8.00	2.00	12.00

PDFNWB3.3×3.3-8L Tape Leader and Trailer

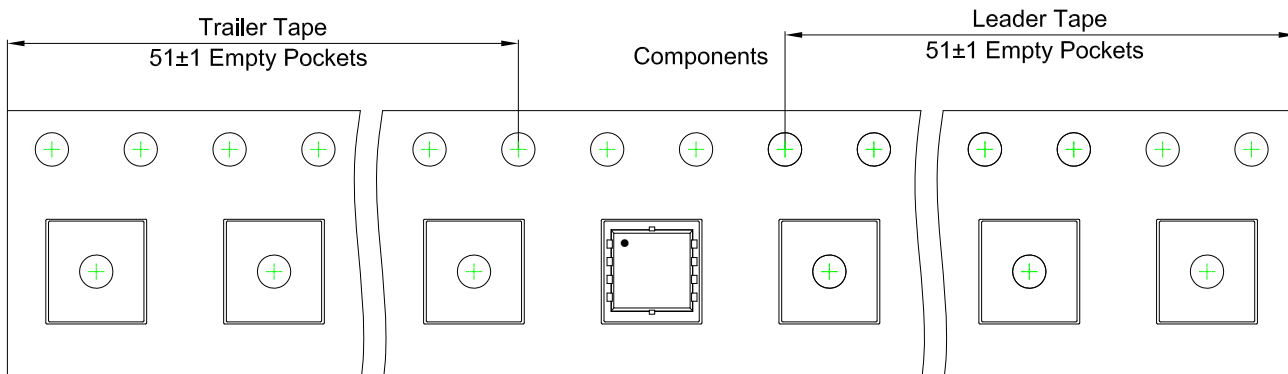

PDFNWB3.3×3.3-8L Reel

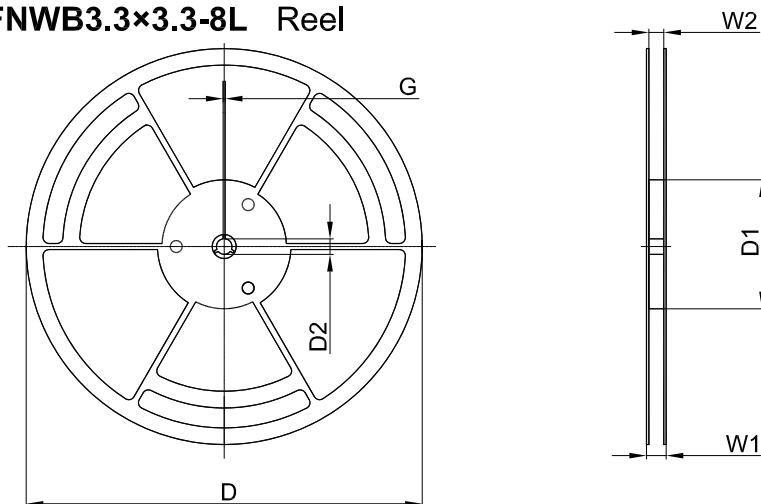

Dimensions are in millimeter						
Reel Option	D	D1	D2	G	W1	W2
13" Dia	Ø330.00	100.00	13.00	1.90	17.60	12.40

REEL	Reel Size	Box	Box Size(mm)	Carton	Carton Size(mm)
5,000 pcs	13 inch	5,000 pcs	340×336×29	50,000 pcs	353×346×365