

L-GAGE® LE250/550 Analog/Discrete Laser Gauging Sensors

Instruction Manual

Original Instructions
175094 Rev. H
20 January 2022
© Banner Engineering Corp. All rights reserved



175094

Contents

1 Product Description	3
1.1 Models	3
1.2 Overview	3
1.2.1 Features and Indicators	4
1.2.2 Display	4
1.2.3 Buttons	4
1.3 Laser Description and Safety Information	5
2 Sensor Installation	7
2.1 Sensor Orientation	7
2.2 Mount the Device	7
2.3 Wiring Diagrams	8
3 Sensor Programming	9
3.1 Quick Menu	9
3.2 Sensor Menu (MENU)	9
3.3 Remote Input	10
3.4 Locking and Unlocking the Sensor	12
3.5 Analog Output Menu (A_OUT)	12
3.5.1 TEACH 4 mA (0 V) and TEACH 20 mA (10 V)	13
3.5.2 Midpoint TEACH	14
3.5.3 Adjust 4 mA (0 V)	16
3.5.4 Adjust 20 mA (10 V)	16
3.5.5 Slope	17
3.5.6 Loss of Signal	17
3.6 Discrete Output Menu (D_OUT)	19
3.6.1 Two-Point TEACH	19
3.6.2 Midpoint TEACH	21
3.6.3 Adjust Switch Point One	23
3.6.4 Adjust Switch Point Two	23
3.6.5 TEACH Switch Point	23
3.6.6 Adjust Switch Point	24
3.6.7 Mode	24
3.6.8 Switch Point Reference (SPtRef)	25
3.6.9 Timer	26
3.6.10 Polarity	26
3.7 Input Menu (INPUT)	26
3.7.1 Input Type	27
3.7.2 Input Active	27
3.8 Measure Menu (MEASURE)	27
3.8.1 Speed	27
3.8.2 Trigger	28
3.9 Display Menu (DISPLAY)	30
3.9.1 Units	30
3.9.2 View	30
3.9.3 Sleep	30
3.10 Information Menu (INFO)	31
3.11 Reset Menu (RESET)	31
3.11.1 Factory Default Settings	32
4 Sync Master/Slave	33
5 Additional Remote TEACH Procedures	34
5.1 TEACH Analog Output and Discrete Output Switch Points Together	34
5.2 TEACH Analog Output and Discrete Output Midpoints Together	34
6 Specifications	36
6.1 Performance Curves	37
6.2 Dimensions	39
7 Troubleshooting	40
8 Sensor Menu Full Map (LE550 Analog/Discrete Models)	41
9 Accessories	42
9.1 Cordsets	42
9.2 Brackets	42
10 Banner Engineering Corp Limited Warranty	44

1 Product Description

Laser displacement sensor with both analog and discrete (switched) outputs

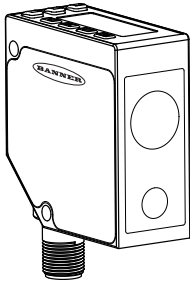

- Easy to set up and use with a 2-line, 8-character display
- Economical sensor with high accuracy
- Repeatability and accuracy for challenging targets, from shiny metal to black rubber
- Various sizes of visible red laser, depending on target size, distance, and color characteristics
- Sensing range options up to 1 meter



WARNING:

- **Do not use this device for personnel protection**
- Using this device for personnel protection could result in serious injury or death.
- This device does not include the self-checking redundant circuitry necessary to allow its use in personnel safety applications. A device failure or malfunction can cause either an energized (on) or de-energized (off) output condition.

1.1 Models

Family	Range	Output	Laser Class	Connector
LE	550	I		Q
	550 = 100-1000 mm 250 = 100-400 mm	I = 4 to 20 mA analog and (1) NPN/PNP discrete U = 0 to 10 V analog and (1) NPN/PNP discrete	Blank = Class 2 laser C1 = Class 1 Laser	Blank = 2 m Integral Cable Q = Rotatable M12 QD QP = PVC M12 150 mm QD W/30 = 9 m Integral Cable
				QD models require mating cordset

NOTE: Discrete NPN/PNP is user configurable

1.2 Overview

The L-GAGE LE250/550 Analog/Discrete Laser Sensor is a visible, bore-sighted laser displacement sensor designed for precise, color-insensitive measurements. The LE series of sensors includes models covering various ranges, spot sizes, and measurement performance.

A 2-line LCD shows the real-time distance measurement, in either millimeters or inches, and the analog output measurement, in milliamps or volts, when the sensor is in Run mode.

See [Factory Default Settings](#) on page 32 for a list of sensor default settings.

Models with current or voltage analog outputs are available. This manual provides the display information and the navigation paths for the current models with the voltage model text in parentheses if it is different.

1.2.1 Features and Indicators

Figure 1. LE Analog Sensor Features

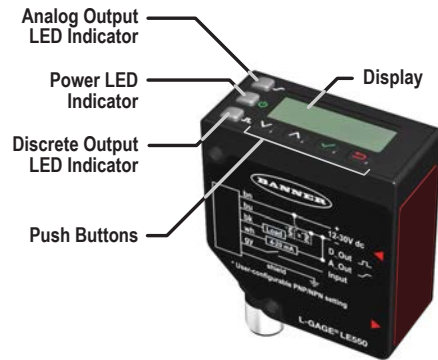

Three LED indicators provide ongoing indication of the sensing status.

Analog Output LED Indicator

Solid Amber = Displayed distance is within the taught analog output window

Off = Displayed distance is outside the taught analog output window

Power LED Indicator

Solid Green = Normal operation, power On and laser On

Flashing Green (1 Hz) = Power On and laser Off (laser enable mode)

Discrete Output LED Indicator

Solid Amber = Discrete Output is On

Off = Discrete Output is Off

1.2.2 Display

Figure 2. LE550 Display in Run Mode



The display is a 2-line, 8-character LCD. The main screen is the Run mode screen, which shows the real-time distance measurement and the analog output measurement.

1.2.3 Buttons

Use the sensor buttons **Down**, **Up**, **Enter**, and **Escape** to program the sensor and to access sensor information.



Down and Up Buttons

Press **Down** and **Up** to:

- Access the Quick Menu from Run mode
- Navigate the menu systems
- Change programming settings

When navigating the menu systems, the menu items loop.

Press **Down** and **Up** to change setting values. Press and hold the buttons to cycle through numeric values. After changing a setting value, it slowly flashes until the change is saved using the **Enter** button.



Enter Button

Press **Enter** to:

- Access the Sensor Menu from Run mode
- Access the submenus
- Save changes

In the Sensor Menu, a check mark '✓' in the lower right corner of the display indicates that pressing **Enter** accesses a submenu.

Press **Enter** to save changes. New values flash rapidly and the sensor returns to the parent menu.



Escape Button

Press **Escape** to:

- Leave the current menu and return to the parent menu
- Return to Run mode from the Quick Menu



Important: Pressing **Escape** discards any unsaved programming changes.

In the Sensor Menu, a return arrow  in the upper left corner of the display indicates that pressing **Escape** returns to the parent menu.

Press and hold **Escape** for 2 seconds to return to Run mode from any menu or remote teach.

1.3 Laser Description and Safety Information



CAUTION:

- **Return defective units to the manufacturer.**
- Use of controls or adjustments or performance of procedures other than those specified herein may result in hazardous radiation exposure.
- Do not attempt to disassemble this sensor for repair. A defective unit must be returned to the manufacturer.

1.3 Class 2 Laser Models



CAUTION:

- **Never stare directly into the sensor lens.**
- Laser light can damage your eyes.
- Avoid placing any mirror-like object in the beam. Never use a mirror as a retroreflective target.



For Safe Laser Use - Class 2 Lasers

- Do not stare at the laser.
- Do not point the laser at a person's eye.
- Mount open laser beam paths either above or below eye level, where practical.
- Terminate the beam emitted by the laser product at the end of its useful path.

Reference IEC 60825-1:2007, Section 8.2.

Class 2 Lasers

Class 2 lasers are lasers that emit visible radiation in the wavelength range from 400 nm to 700 nm, where eye protection is normally afforded by aversion responses, including the blink reflex. This reaction may be expected to provide adequate protection under reasonably foreseeable conditions of operation, including the use of optical instruments for intrabeam viewing.

Class 2 Laser Safety Notes

Low-power lasers are, by definition, incapable of causing eye injury within the duration of a blink (aversion response) of 0.25 seconds. They also must emit only visible wavelengths (400 to 700 nm). Therefore, an ocular hazard may exist only if individuals overcome their natural aversion to bright light and stare directly into the laser beam.

Figure 3. FDA (CDRH) warning label (Class 2)



1.3 Class 1 Laser Models

Class 1 lasers are lasers that are safe under reasonably foreseeable conditions of operation, including the use of optical instruments for intrabeam viewing.

Laser wavelength: 650 nm **Output:** < 0.22 mW **Pulse Duration:** 150 μ s to 900 μ s

Figure 4. FDA (CDRH) warning label (Class 1)



2 Sensor Installation



Note: Handle the sensor with care during installation and operation. Sensor windows soiled by fingerprints, dust, water, oil, etc. may create stray light that may degrade the peak performance of the sensor. Blow the window clear using filtered, compressed air, then clean as necessary using 70% isopropyl alcohol and cotton swabs or water and a soft cloth.

2.1 Sensor Orientation

Correct sensor-to-object orientation is important to ensure proper sensing. See the following figures for examples of correct and incorrect sensor-to-object orientation as certain placements may pose problems for sensing distances.

Figure 5. Orientation by a wall

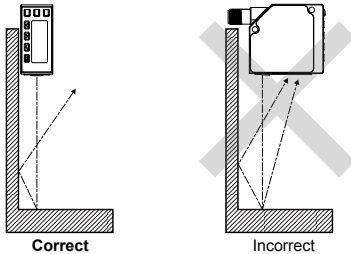

Figure 6. Orientation in an opening

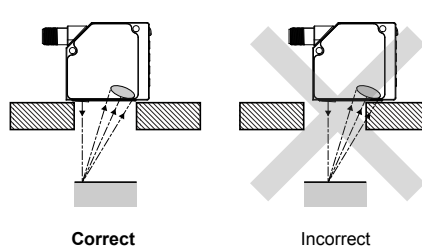

Figure 7. Orientation for a turning object

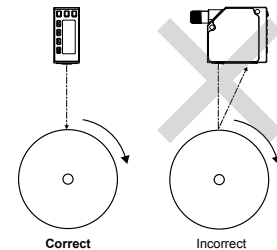

Figure 8. Orientation for a height difference

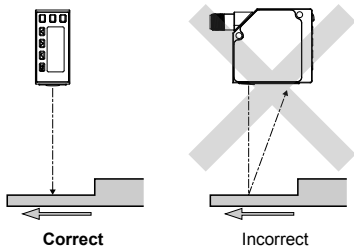

Figure 9. Orientation for a color or luster difference

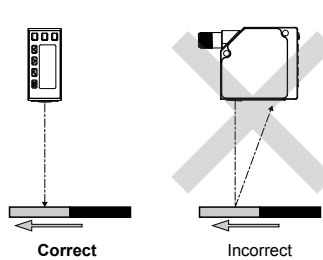
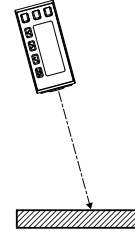

Figure 10. Orientation for a highly reflective target



Applying tilt to sensor may improve performance on reflective targets. The direction and magnitude of the tilt depends on the application, but a 15° tilt is often sufficient.

2.2 Mount the Device

1. If a bracket is needed, mount the device onto the bracket.
2. Mount the device (or the device and the bracket) to the machine or equipment at the desired location. Do not tighten the mounting screws at this time.
3. Check the device alignment.
4. Tighten the mounting screws to secure the device (or the device and the bracket) in the aligned position.

2.3 Wiring Diagrams

Figure 11. Analog Current Model

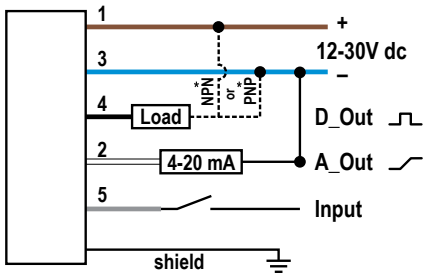

* User-configurable PNP/NPN setting

Figure 12. Analog Voltage Model

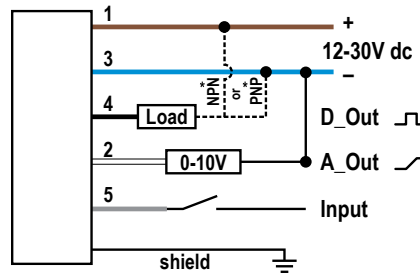

* User-configurable PNP/NPN setting

Key

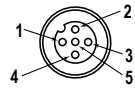

- 1 = Brown
- 2 = White
- 3 = Blue
- 4 = Black
- 5 = Gray

Figure 15. Sensor Menu Basic Map

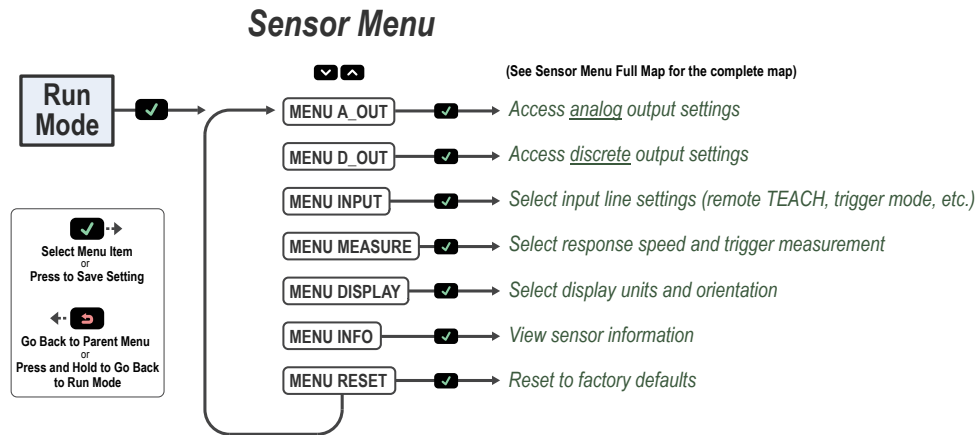

See [Sensor Menu Full Map \(LE550 Analog/Discrete Models\)](#) on page 41 and the Menu sections of this manual for more information.

3.3 Remote Input

Use the remote input to program the sensor remotely. The remote input provides limited programming options.

The remote input is Active Low by default. For Active Low, connect the gray input wire to ground (0 V DC), with a remote switch connected between the wire and ground. To use the Active High function, configure the sensor for Active High using the buttons on the sensor, then connect the gray input wire to V+ (12 to 30 V DC). Pulse the remote input according to the diagram and the instructions provided in this manual.

The length of the individual programming pulses is equal to the value **T: 0.04 seconds ≤ T ≤ 0.8 seconds**.

Exit remote programming modes by holding the remote input low for > 2 seconds, or waiting for the automatic 60-second timeout, or by pressing and holding **Escape** (Escape key) for 2 seconds. The sensor returns to Run mode without saving any new settings.

Figure 16. Remote Input Map

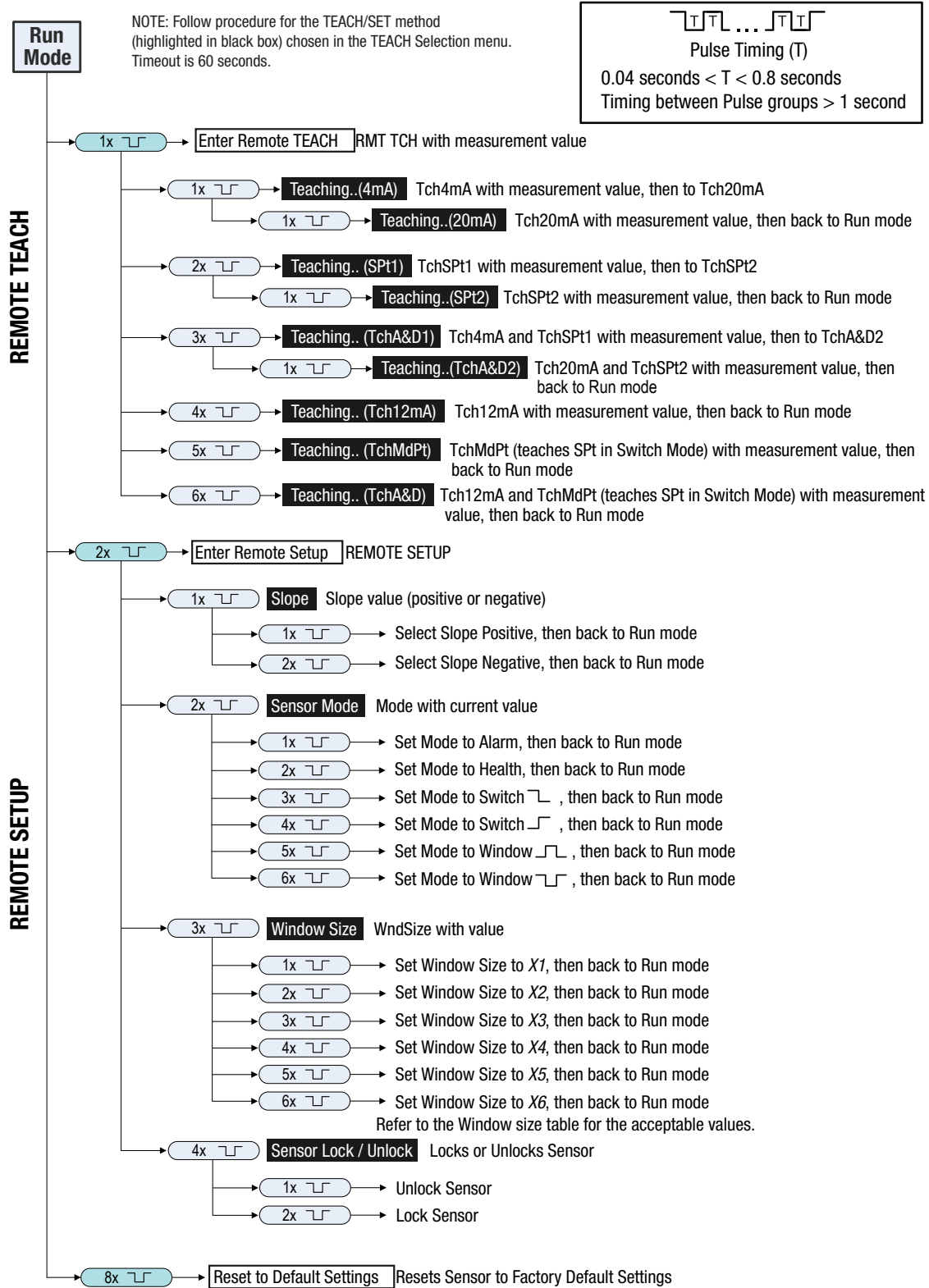





Table 1: Window Size (WndSize)

Variable	LE250 Models	LE550 Models	Variable	LE250 Models	LE550 Models
X1	1 mm	10 mm	X4	100 mm	300 mm
X2	10 mm	50 mm	X5	150 mm	500 mm
X3	50 mm	100 mm	X6	250 mm	800 mm

3.4 Locking and Unlocking the Sensor

Use the lock and unlock feature to prevent unauthorized or accidental programming changes. A lock symbol  displays in the upper left corner of the display to indicate when the sensor is locked. When locked, the menus are available to view settings, but the values cannot be changed. The remote input is also disabled, except for the unlock function.

Button Instructions

To lock or unlock the sensor using the buttons, press and hold **Down**  and **Escape**  simultaneously for 3 seconds.

Remote Input Instructions

1. Access the setup mode.

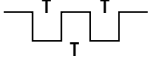
Action		Result
Double-pulse the remote input.		"REMOTE SETUP" displays.

2. Access the lock/unlock function.

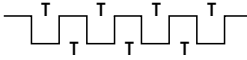
Action		Result
Four-pulse the remote input.		"LOCK" and the current status (unlocked or locked) display.

3. Lock or unlock the sensor.

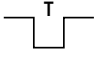
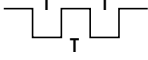
Action		Result
Unlock : Single-pulse the remote line.		"Unlocked" flashes and the sensor returns to Run mode. The sensor is unlocked.
Lock : Double-pulse the remote input.		"Locked" flashes and the sensor returns to Run mode. The sensor is locked and the lock symbol displays in the upper left corner.

3.5 Analog Output Menu (A_OUT)

Use the Analog Output menu to view or change:

- 4 mA (0 V) setpoint
- 20 mA (10 V) setpoint
- 12 mA (5 V) window
- Slope
- Loss of signal behavior

Figure 17. Analog Output Menu Map

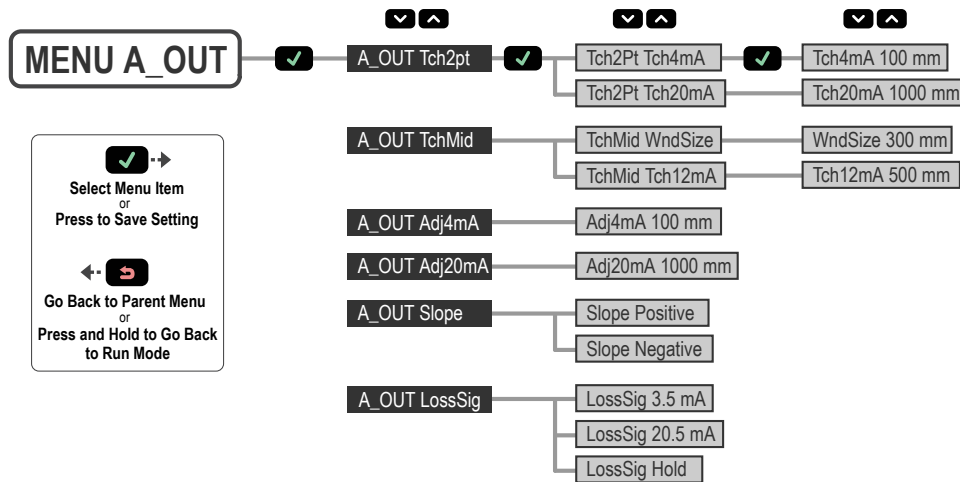

3.5.1 TEACH 4 mA (0 V) and TEACH 20 mA (10 V)

The Tch4mA (Tch0V) and Tch20mA (Tch10V) options use targets to set the 4 mA (0 V) and 20 mA (10 V) to the desired setpoints. When using the buttons, only one value needs to be set if the second value is valid. When using the remote input, both values must be set.

Navigate: MENU > A_OUT > Tch2Pt > Tch4mA (Tch0V) or navigate: MENU > A_OUT > Tch2Pt > Tch20mA (Tch10V)

Remote input: Available

Button Instructions

1. Present the target.

Action	Result
Present the target. The target must be within the sensor's measurement range.	The target's analog output measurement and distance measurement values display.

2. Access the TEACH mode and TEACH the sensor.

Action	Result
Navigate: MENU > A_OUT > Tch2Pt > Tch4mA (Tch0V) OR Navigate: MENU > A_OUT > Tch2Pt > Tch20mA (Tch10V)	The selected TEACH mode and "Teaching" display while the sensor is being taught. TEACH Accepted The new value is shown on the second line of the display and flashes before it is saved and the sensor returns to the parent menu. TEACH Not Accepted "FAIL" and a warning message display, and the sensor returns to the parent menu.

3. Repeat steps 1 to 2 for the other setpoint, if desired.

Remote Input Instructions

Teaches both the 4 mA (0 V) and 20 mA (10 V) setpoints.

1. Access the TEACH mode.

Action	Result
Single-pulse the remote input. 	"RMT TCH" and the current measurement value display.

2. Present the target.

Action	Result
Present the 4 mA (0 V) target.	"RMT TCH" and the target's measurement value display.

3. TEACH the sensor.

Action	Result
Single-pulse the remote input. 	"Tch4mA (Tch0V) Teaching" displays while the sensor is being taught. TEACH Accepted The new value displays on the second line of the display, flashes, and then "Tch20mA (Tch10V)" and the current measurement value display. TEACH Not Accepted "FAIL" flashes, the sensor returns to step 2, and "RMT TCH" displays.

4. Present the target.

Action	Result
Present the 20 mA (10 V) target.	"Tch20mA (Tch10V)" and the target's measurement value display.

5. TEACH the sensor.

Action	Result
Single-pulse the remote input. 	"Tch20mA (Tch10V) Teaching" displays while the sensor is being taught. TEACH Accepted The new value displays on the second line of the display, flashes, and the sensor returns to Run mode. TEACH Not Accepted "FAIL" flashes, the sensor returns to step 2, and "RMT TCH" displays.

3.5.2 Midpoint TEACH

Figure 18. Window and Midpoint Example

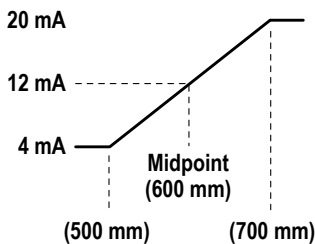

The Midpoint TEACH uses both the window size and the 12 mA (5 V) setpoint to determine the actual measurement window. For example, a window of 200 mm with a 12 mA (5 V) setpoint of 600 mm places the measurement window from 500 mm to 700 mm.

To use the Midpoint TEACH:

1. Set the window size.
2. Set the measurement window using [TEACH 12 mA \(5 V\)](#) on page 15.

The Analog Output Midpoint TEACH and the Discrete Output Midpoint TEACH are independent settings (see [Midpoint TEACH](#) on page 21).

Window Size

The WndSize option sets the window size that the Midpoint TEACH uses to set the 4 mA (0 V) and 20 mA (10 V) setpoints. The Midpoint TEACH fails if one of the setpoints is beyond the measurement range. The bigger the window size, the smaller the acceptable TEACH range.

The Analog Output window size is a different setting than the Discrete Output window size when defined using the push buttons.

	LE250 Laser Sensor	LE550 Laser Sensor
Window Size Minimum	1 mm	10 mm



	LE250 Laser Sensor	LE550 Laser Sensor
Window Size Maximum	250 mm	800 mm
Range	100 mm to 400 mm	100 mm to 1000 mm
Default Window Size	50 mm	300 mm

Navigate: MENU > A_OUT > TchMid > WndSize

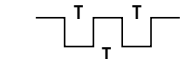

Remote Input: Available

Default: 300 (11.8 in) mm for LE550 models; 50.0 mm (1.97") for LE250 models

1. Access the Window Size mode.

Method	Action	Result
Push Button	Navigate: MENU > A_OUT > TchMid > WndSize	"WndSize" and the current window size value display.
Remote Input	<p>a. Double-pulse the remote input to enter setup mode.</p>  <p>b. Three-pulse the remote input to enter window size mode.</p> 	<p>a. "REMOTE SETUP" displays.</p> <p>b. "WndSize" and the current window size value display.</p>

2. Set the window size.

Method	Action	Result																								
Push Button	<p>a. Use Down  and Up  and to set the desired window size—the value changes in increments of 2.</p> <p>b. Press Enter  to save the new value.</p>	<p>a. "WndSize" and the new value display.</p> <p>b. The new value flashes and the sensor returns to "TchMid WndSize".</p>																								
Remote Input (Sets A_OUT and D_OUT window Size)	<p>Pulse the remote input 1 to 6 times to select the desired window size.</p> <table border="1" data-bbox="406 1186 1128 1522"> <thead> <tr> <th colspan="3">Window Size</th> </tr> <tr> <th>Pulses</th> <th>LE250</th> <th>LE550</th> </tr> </thead> <tbody> <tr> <td>1</td> <td>1 mm</td> <td>10 mm</td> </tr> <tr> <td>2</td> <td>10 mm</td> <td>50 mm</td> </tr> <tr> <td>3</td> <td>50 mm</td> <td>100 mm</td> </tr> <tr> <td>4</td> <td>100 mm</td> <td>300 mm</td> </tr> <tr> <td>5</td> <td>150 mm</td> <td>500 mm</td> </tr> <tr> <td>6</td> <td>250 mm</td> <td>800 mm</td> </tr> </tbody> </table>	Window Size			Pulses	LE250	LE550	1	1 mm	10 mm	2	10 mm	50 mm	3	50 mm	100 mm	4	100 mm	300 mm	5	150 mm	500 mm	6	250 mm	800 mm	<p>The new value flashes and the sensor returns to Run mode.</p>
Window Size																										
Pulses	LE250	LE550																								
1	1 mm	10 mm																								
2	10 mm	50 mm																								
3	50 mm	100 mm																								
4	100 mm	300 mm																								
5	150 mm	500 mm																								
6	250 mm	800 mm																								

TEACH 12 mA (5 V)

The Tch12mA (Tch5V) option sets the midpoint that determines the actual measurement window.

Navigate: MENU > A_OUT > TchMid > Tch12mA (Tch5V)

Remote Input: Available

Button Instructions

1. Present the target.

Action	Result
Present the target.	The target's analog output measurement and distance measurement values display.

2. Access the TEACH 12 mA (5 V) mode and TEACH the sensor.

Action	Result
Navigate: MENU > A_OUT > TchMid > Tch12mA (Tch5V) .	<p>"Tch12mA (Tch5V) Teaching" displays while the sensor is being taught.</p> <p>TEACH Accepted</p> <p>The new value is shown on the second line of the display and flashes before it is saved and the sensor returns to "TchMid Tch12mA (Tch5V)".</p> <p>TEACH Not Accepted</p> <p>"FAIL" and a warning message display and the sensor returns to "Tch Mid Tch12mA (Tch5V)".</p>

Remote Input Instructions

1. Access the TEACH mode.

Action	Result
Single-pulse the remote input. 	"RMT TCH" and the current measurement value display.

2. Present the target.

Action	Result
Present the target.	"RMT TCH" and the target's measurement value display.

3. TEACH the sensor.

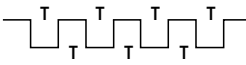
Action	Result
Four-pulse the remote input. 	<p>"Tch12mA (Tch5V) Teaching" displays while the sensor is being taught.</p> <p>TEACH Accepted</p> <p>The new value displays on the second line of the display, flashes, and the sensor returns to Run mode</p> <p>TEACH Not Accepted</p> <p>"FAIL" flashes, the sensor returns step 2, and "RMT TCH" displays.</p>

3.5.3 Adjust 4 mA (0 V)

The Adj4mA (Adj0V) option manually adjusts the distance at which the Analog Output is 4mA (0 V). The value is adjustable within the sensor's range. It is required to at least maintain the minimum window size.

Navigate: MENU > A_OUT > Adj4mA (Adj0V)

Remote Input: Not available

Default: 100 mm (3.94 in) for both LE250 and LE550 models

3.5.4 Adjust 20 mA (10 V)

The Adj20mA (Adj10V) option manually adjusts the distance at which the Analog Output is 20 mA (10 V). The value is adjustable between the sensor's range. It is required to at least maintain the minimum window size.

Navigate: MENU > A_OUT > Adj20mA (Adj10V)

Remote Input: Not available

Default: 400 mm for the LE250 models; 1000 mm (39.37 in) for the LE550 models

3.5.5 Slope

The Slope option sets the slope as positive or negative. This swaps the 4 mA and 20 mA (0 V and 10 V) values.

Navigate: MENU > A_OUT > Slope

Remote Input: Available

Default: Positive

Figure 19. Slope—Current-Sourcing Models

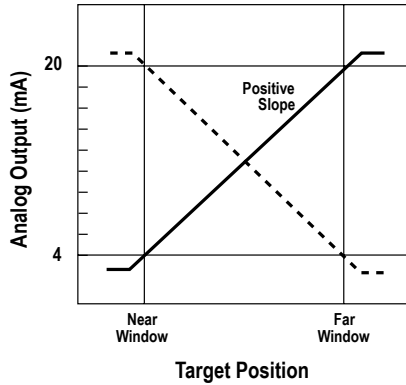
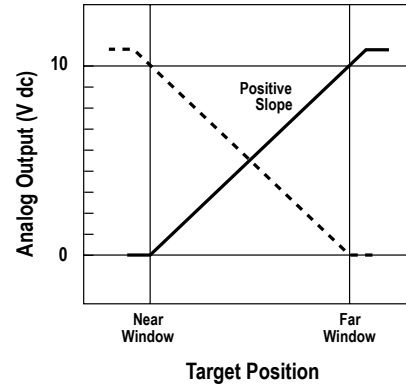

Figure 20. Slope—Voltage-Sourcing Models





The analog current output tracks slightly beyond each window limit (from 3.8 mA to 20.2 mA)

The analog voltage output tracks slightly beyond the upper window limit (up to 10.2 V)

1. Access the slope setting.

Method	Action	Result
Push Button	Navigate: MENU > A_OUT > Slope	"Slope" and the current setting display.
Remote Input	a. Double-pulse the remote input to enter setup mode.	a. "REMOTE SETUP" displays.
	b. Single-pulse the remote input to access A_OUT Slope.	b. "Slope" and the current setting display.

2. Set the slope.

Method	Action	Result
Push Button	a. Use Down  and Up  to change the slope between Positive and Negative. b. Press Enter  to save the selection.	a. The selection flashes rapidly on the display. b. The selection is saved and the sensor returns to "A_OUT Slope".
Remote Input	Positive slope: Single-pulse the remote input Negative slope: Double-pulse the remote input	The selection flashes rapidly on the display, and the sensor returns to Run mode.

3.5.6 Loss of Signal

The LossSig option sets the Analog Output value used by the sensor during a loss of signal. When a signal is restored, measurement resumes.

Navigate: Menu > A_Out > LossSig

Remote Input: Not available

Default: 3.5 mA (0 V)

Option	Description
3.5 mA (0 V)	The Analog Output switches to this value 2 seconds after a loss of signal. When advanced measurements are enabled, the Analog Output is updated to this value immediately upon the release of the trigger input. For Voltage models, this is 0 V. (Default)
20.5 mA (10.5 V)	The Analog Output switches to this value 2 seconds after a loss of signal. When advanced measurements are enabled, the Analog Output is updated to this value immediately upon the release of the trigger input. For Voltage models, this is 10.5 V.
Hold	The Analog Output holds the last value indefinitely during a loss of signal. When advanced measurements are enabled, the last value is held across the triggered measurement periods.

The Range advanced measurement behavior is affected by the Loss of Signal option. For additional information on advanced measurements, see [Trigger](#) on page 28. The Range advanced measurement tracks a maximum and a minimum during the measurement period, and calculates the range as follows:

$$\text{Range} = \text{maximum distance} - \text{minimum distance}$$

If the maximum and/or minimum measurements are outside of the taught setpoints, the Loss of Signal option determines how the range is calculated.

Option	Sensor Behavior in Range Mode
3.5 mA (0 V)	If the maximum or minimum measurement is outside of the taught setpoints, the sensor outputs 3.5 mA (0 V) to indicate an out of range measurement.
20.5 mA (10.5 V)	If the maximum or minimum measurement is outside of the taught setpoints, the sensor outputs 20.5 mA (10.5 V) to indicate an out of range measurement.
Hold	The sensor limits the maximum and minimum measurements so that they cannot exceed the taught setpoints.

3.6 Discrete Output Menu (D_OUT)

Use this menu to view or change

- Setpoints
- Midpoint
- Mode
- Timers
- Polarity

Figure 21. Discrete Output Menu Map

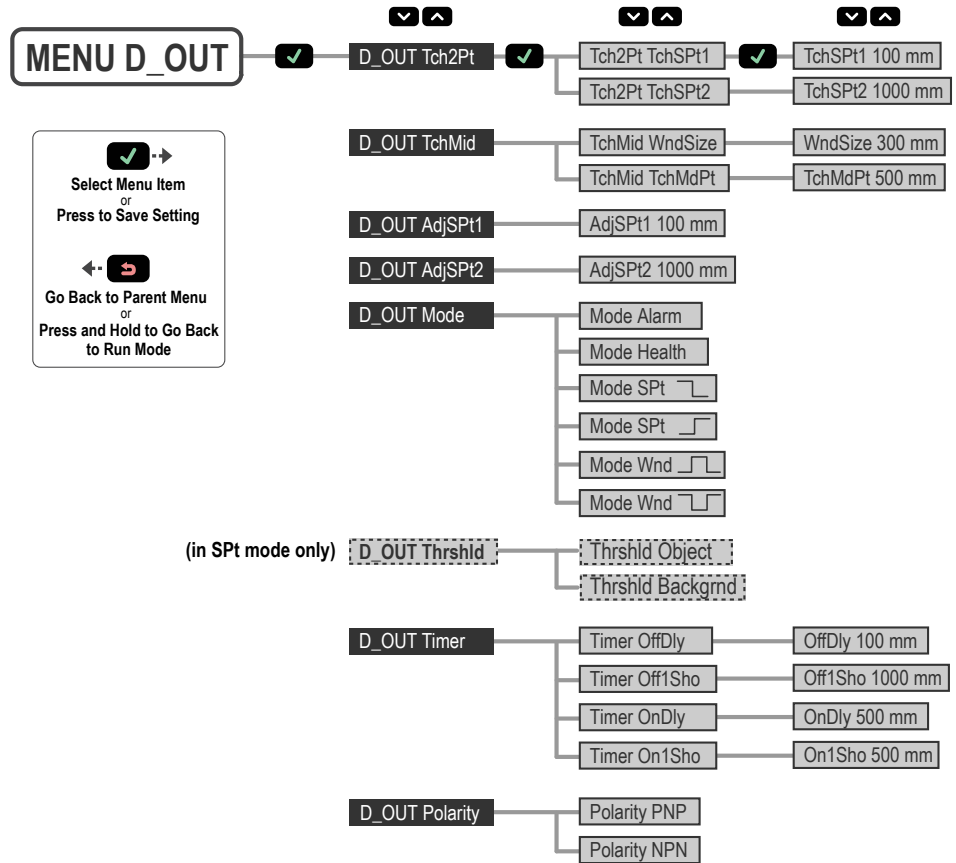

3.6.1 Two-Point TEACH

The TchSpt1 and TchSpt2 options teach the desired switch points. When using the buttons, the switch points can be taught independently. Both values must be taught when using the remote input.

Note: When in Switch mode, use [TEACH Switch Point](#) on page 23.

Navigate: MENU > D_OUT > Tch2Pt > TchSPt1 and navigate: MENU > D_OUT > Tch2Pt > TchSPt2

Remote Input: Available

Button Instructions

1. Present the target.

Action	Result
Present the target. The target must be within the sensor's range..	The target's analog output measurement and distance measurement value display.

2. Access the TEACH mode and TEACH the sensor.

Action	Result
Navigate: MENU > D_OUT > Tch2Pt > TchSPt1 OR Navigate: MENU > D_OUT > Tch2Pt > TchSPt2	The selected TEACH mode and " Teaching " display while the sensor is being taught. TEACH Accepted The new value is shown on the second line of the display and flashes before it is saved and the sensor returns to the parent menu. TEACH Not Accepted "FAIL" and a warning message display, and the sensor returns to the parent menu.

- Repeat steps 1 to 2 for the other switch point, if desired.

Remote Input Instructions

- Access the TEACH mode.

Action		Result
Single-pulse the remote input.		"RMT TCH" and the current switch point value displays.

- Present the target.

Action	Result
Present the switch point one target.	"RMT TCH" and the target's measurement value display.

- TEACH the sensor.

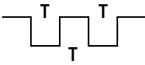
Action		Result
Double-pulse the remote input.		"TchSPt1 Teaching" displays while the sensor is being taught. TEACH Accepted The new value displays on the second line of the display, flashes, and the sensor goes to "TchSPt2" and the current measurement value. TEACH Not Accepted "FAIL" flashes, the sensor returns to step 2, and "RMT TCH" displays.

- Present the target.

Action	Result
Present the switch point two target.	"TchSPt2" and the target's measurement value display.

- TEACH the sensor.

Action		Result
Single-pulse the remote input.		"TchSPt2 Teaching" displays while the sensor is being taught. TEACH Accepted The new value displays on the second line of the display, flashes, and the sensor returns to Run mode. TEACH Not Accepted "FAIL" flashes, the sensor returns to step 2, and "RMT TCH" displays.

3.6.2 Midpoint TEACH

Figure 22. Window and Midpoint Example

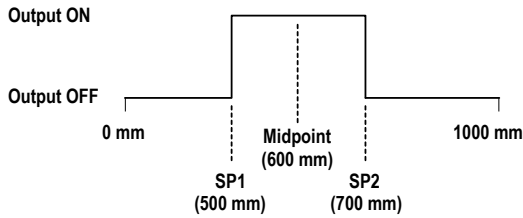

The Midpoint TEACH uses both the window size and the TEACH midpoint to determine the actual measurement window. For example, a window of 200 mm with a midpoint of 600 mm places the measurement window from 500 mm to 700 mm.

To use Midpoint TEACH:

1. Set the window size.
2. Set the measurement window using [TEACH Midpoint](#) on page 22.

The Discrete Output Midpoint TEACH and the Analog Output Midpoint TEACH are independent settings.

Window Size

The WndSize option sets the window size that the Midpoint TEACH uses to set the setpoint one and setpoint two thresholds. The Midpoint TEACH fails if one of the setpoints is beyond the measurement range. The bigger the window size, the smaller the acceptable TEACH range.

The Discrete Output window size is a different setting than the Analog Output window size when defined using the button.

	LE250 Laser Sensor	LE550 Laser Sensor
Window Size Minimum	1 mm	10 mm
Window Size Maximum	250 mm	800 mm
Range	100 mm to 400 mm	100 mm to 1000 mm
Default Window Size	50 mm	300 mm

Navigate: MENU > D_OUT > TchMid > WndSize

Remote Input: Available

1. Access the setup mode.

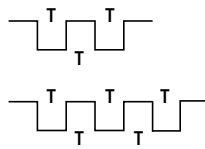
Method	Action	Result
Push Button	Navigate: MENU > D_OUT > TchMid > WndSize .	"WndSize" and the current window size value display.
Remote Input	a. Double-pulse the remote input to enter setup mode. b. Three-pulse the remote input to enter window size mode.	 a. "REMOTE SETUP" displays. b. "WndSize" and the current value display.

2. Set the window size.

Method	Action	Result
Push Button	a. Use Down and Up to set the desired window size—the value changes in increments of 2. b. Press Enter to save the new value.	a. "WndSize" and the new value display. b. The new value flashes and returns to "TchMid WndSize".

Method	Action	Result			
Remote Input (Sets A_OUT and D_OUT window Size)	Pulse the remote input 1 to 6 times to select the desired window size.		The new value flashes and the sensor returns to Run mode.		
	Window Size				
	Pulses			LE250	LE550
	1			1 mm	10 mm
	2			10 mm	50 mm
	3			50 mm	100 mm
	4			100 mm	300 mm
	5			150 mm	500 mm
6		250 mm	800 mm		

TEACH Midpoint

The TchMdPt option sets the midpoint that determines the actual measurement window.

Navigate: MENU > D_OUT > TchMid > TchMdPt

Remote Input: Available

Button Instructions

1. Present the target.

Action	Result
Present the target.	The target's analog output measurement and distance measurement value display.

2. Access the TEACH midpoint mode and TEACH the sensor.

Action	Result
Navigate: MENU > D_OUT > TchMid > TchMdPt	<p>"TchMdPt Teaching" displays while the sensor is being taught.</p> <p>TEACH Accepted</p> <p>The new value is shown on the second line of the display and flashes before it is saved and the sensor returns to "TchMid TchMdPt".</p> <p>TEACH Not Accepted</p> <p>"FAIL" and a warning message display, and the sensor returns to "TchMid TchMdPt".</p>

Remote Input Instructions

1. Access the TEACH mode.

Action	Result
Single-pulse the remote input. 	"RMT TCH" and the current measurement value display.

2. Present the target.

Action	Result
Present the target.	"RMT TCH" and the target's measurement value display.

3. TEACH the sensor.

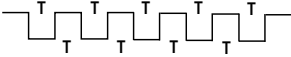
Action	Result
Five-pulse the remote input. 	<p>"TchMdpt Teaching" displays while the sensor is being taught.</p> <p>TEACH Accepted</p> <p>The new value displays on the second line of the display, flashes, and the sensor returns to Run mode.</p> <p>TEACH Not Accepted</p> <p>"FAIL" and a warning message display, the sensor returns to step 2, and "RMT TCH" displays.</p>

3.6.3 Adjust Switch Point One

The AdjSPt1 option manually adjusts the value of the switch point one threshold for the Discrete Output when the sensor is in Window mode. The value is adjustable within the sensor's range. It is required to be maintain the minimum window size between switch points. This menu is not available when the sensor is in Switch, Alarm, or Health mode.

Navigate: MENU > D_OUT > AdjSPt1

Remote Input: Not available

Default: 100 mm for both the LE250 and LE550 models.

3.6.4 Adjust Switch Point Two

The AdjSPt2 option manually adjusts the value of the switch point two threshold for the Discrete Output when the sensor is in Window mode. The value is adjustable with the sensor's range. It is required to be maintain the minimum window size between switch points. This menu is not available when the sensor is in Switch, Alarm, or Health mode.

Navigate: MENU > D_OUT > AdjSPt2

Remote Input: Not available

Default: 400 mm for LE250 models and 1000 mm for LE550 models.

3.6.5 TEACH Switch Point

The TchSPt option teaches the distance at which the switch point threshold is placed when the Discrete Output is in Switch mode. This menu is not available when the sensor is in Window, Alarm, or Health mode.

Navigate: MENU > D_OUT > TchSPt

Remote Input: Available

Button Instructions

1. Present the target.

Action	Result
Present the target. The target must be within the sensor's range.	The target's analog output measurement and distance measurement value display.

2. Access the switch point TEACH mode and TEACH the sensor.

Action	Result
Navigate: MENU > D_OUT > TchSPt	<p>"TchSPt Teaching" displays while the sensor is being taught.</p> <p>TEACH Accepted</p> <p>The new value is shown on the second line of the display and flashes before it is saved and the sensor returns to "D_OUT TchSPt".</p> <p>TEACH Not Accepted</p> <p>"FAIL" and a warning message display, and the sensor returns to "D_OUT TchSPt".</p>

Remote Input Instructions

1. Verify the sensor is in Switch mode.
2. Access the TEACH mode.

Action	Result
Single-pulse the remote input. 	"RMT TCH" and the current measurement value display.

3. Present the target.

Action	Result
Present the target.	"RMT TCH" and the target's measurement value display.

4. TEACH the sensor.

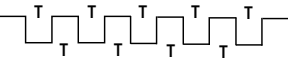
Action	Result
Five-pulse the remote input. 	<p>"TchSPt Teaching" displays while the sensor is being taught.</p> <p>TEACH Accepted</p> <p>The new value displays on the second line of the display, flashes, and the sensor returns to Run mode.</p> <p>TEACH Not Accepted</p> <p>"FAIL" flashes, the sensor returns to step 3, and "RMT TCH" displays.</p>

3.6.6 Adjust Switch Point

The AdjSPt option manually adjusts the value of the switch point threshold for the discrete output when the sensor is in Switch mode. The value is adjustable within the sensor's range. This menu is not available when the sensor is in Window, Alarm, or Health mode.

Navigate: MENU > D_OUT > AdjSPt

Remote Input: Not available

Default: 100 mm for the LE250 and LE550 models

3.6.7 Mode



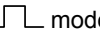

The Mode option sets the output to the desired mode.

Navigate: MENU > D_OUT > Mode

Remote Input: Available

Default: Wnd  mode

The following table describes the sensor modes.

Mode	Description
Alarm	Alarm Mode: The Discrete Output is Off while a target is detected by the sensor at any distance. When a loss of signal occurs, the Discrete Output is On. This mode has no associated thresholds.
Health	Health Mode: The Discrete Output is On while a target is detected by the sensor at any distance. When a loss of signal occurs, the Discrete Output is Off. This mode has no associated thresholds.
Switch 	Switch Mode: The Discrete Output is On while a target is detected nearer than the switch point threshold. When a target is detected farther than the switch point threshold or the signal is lost, the Discrete Output is Off.
Switch 	Switch Mode: The Discrete Output is Off while a target is detected nearer than the switch point threshold. When a target is detected farther than the switch point threshold or the signal is lost, the Discrete Output is On.
Wnd 	Window Mode: The Discrete Output is On while a target is detected between the SPT1 and SPT2 thresholds. (Default) When a target is detected outside the SPT1 and SPT2 thresholds or the signal is lost, the Discrete Output is Off.
Wnd 	Window Mode: The Discrete Output is Off while a target is detected between the SPT1 and SPT2 thresholds. When a target is detected outside the SPT1 and SPT2 thresholds or the signal is lost, the Discrete Output is On.

Remote Input Instructions



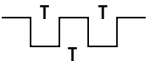



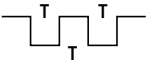

1. Access the setup mode.

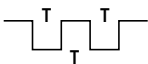
Action		Result
Double-pulse the remote input.		"REMOTE SETUP" displays.

2. View the current mode.

Action		Result
Double-pulse the remote input.		The current mode displays.

3. Program the sensor.

Action		Result
Pulse the remote input 1 to 6 times to select the desired mode.		The selected mode flashes and the sensor returns to Run mode.
Pulses	Mode	
1 	Alarm	
2 	Health	
3 	Switch 	
4 	Switch 	
5 	Wnd 	
6 	Wnd 	

3.6.8 Switch Point Reference (SPtRef)

The SPtRef menu only displays for a discrete output when it is set to switch mode. The SPtRef settings, object or background, for the two discrete outputs are set independently. This setting cannot be changed with remote teach.

- **Object** (default). Object mode sets the switching threshold just past the location of the taught object, farther away from the sensor's face.
- **Background**. Background mode sets the switching threshold in front of the taught object, closer to the sensor's face.

The distance between the surface of the taught object and the switching threshold varies depending on measurement strength and can be affected by target distance, color, reflectivity, etc. Use object mode when teaching an object if a change in state is required when the object is no longer present. Use background mode when teaching background so that the output state changes when a new object is in front of the background.

Navigate: MENU > Dx_OUT > SPtRef

Remote Input: Not available

Default: Object

3.6.9 Timer

The Timer option sets the delays and timers. On/Off Delays and On/Off One-Shot timers can be programmed between 1 to 9999 ms (a value of 0 disables the delay/timer). [Figure 23](#) on page 26 defines how the delays/timers affect the output behavior.

Navigate: MENU > D_OUT > Timer

Remote Input: not available

Default: 0 ms for all timers

Figure 23. Delays/Timers

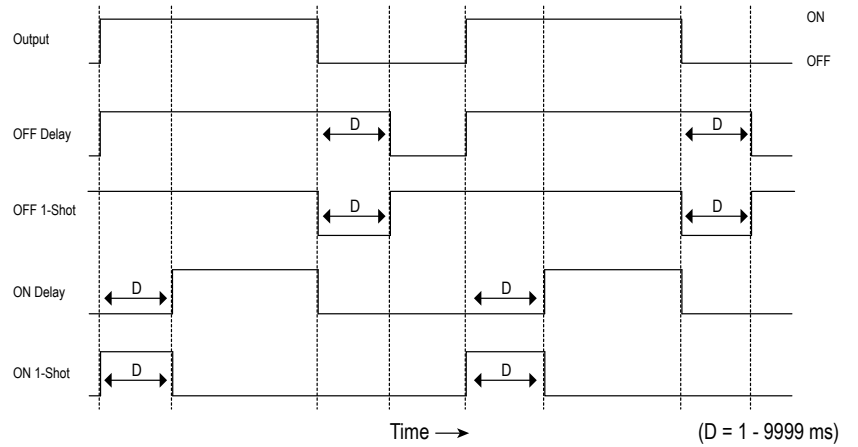

Some combinations of delays/timers are not allowed. The programming menu automatically disables invalid combinations of delays/timers. The following table shows the allowable combinations of delays/timers.

	Off Delay	Off One-Shot Timer	On Delay	On One-Shot Timer
Off Delay (OffDly)	OK	OK	OK	N/A
Off One-Shot Timer (Off1Sho)	OK	OK	N/A	N/A
On Delay (OnDly)	OK	N/A	OK	OK
On One-Shot Timer (On1Sho)	N/A	N/A	OK	OK

3.6.10 Polarity

The Polarity option sets the discrete output polarity to either PNP (current sourcing) or NPN (current sinking). The physical wiring of the sensor and the sensor polarity setting must match.

Navigate: MENU > D_OUT > Polarity

Remote Input: Not available

Default: PNP

3.7 Input Menu (INPUT)

Use this menu to view or change the:

- Multi-function input type
- Active state of the remote input

Figure 24. Input Menu Map

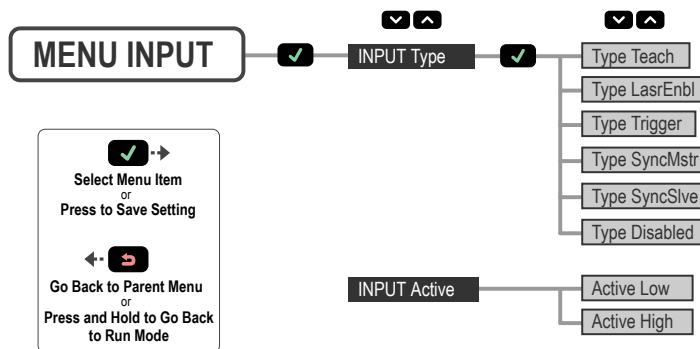

3.7.1 Input Type

The Type option sets the input type.

Navigate: MENU > INPUT > Type

Remote Input: Not available

Default: Teach

Input Type	Description
Teach	The remote input is used to TEACH and program the sensor.
LasrEnbl	The remote input is used to control when the laser emitter is On/Off.
Trigger	The remote input is used to trigger advanced measurements To enable advanced measurements, the Input Type option must be set to Trigger (see Trigger on page 28).
SyncMstr	The remote input is used as the Master Sync output to an attached Slave sensor (see Sync Master/Slave on page 33).
SyncSlve	The remote input is used as the Slave Sync input from an attached Master sensor (see Sync Master/Slave on page 33).
Disabled	The remote input is disabled. (Default)

3.7.2 Input Active

The Active option sets the active state of the remote input. Use the Active options to change the active input to Low or High.

Navigate: MENU > INPUT > Active

Remote Input: Not available

Default: Low

Input Active	Description
Low	The remote input detects low (0 V) inputs and high-to-low transitions. (Default)
High	The remote input detects high (V+) inputs and low-to-high transitions.

3.8 Measure Menu (MEASURE)

Use this menu to view or change the:

- Speed
- Trigger

Figure 25. Measure Menu Map

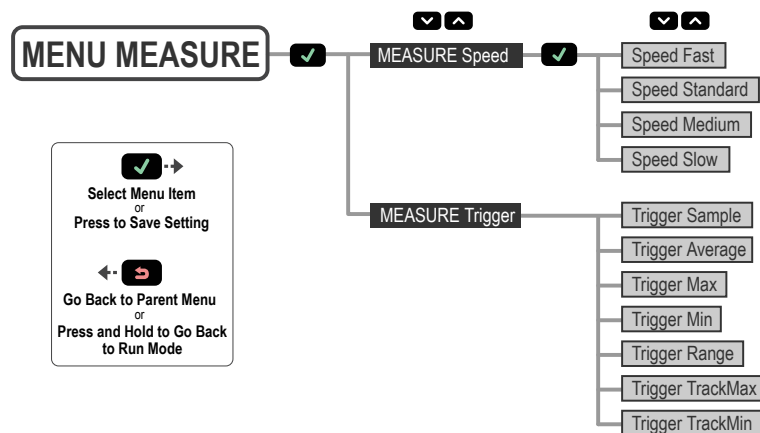

3.8.1 Speed

The Speed option sets the speed at which the measurement is calculated. This process uses averaging in the digital processing of the signal to calculate the measurement. A slower speed increases the response time of the sensor but improves the repeatability. See [Figure 37](#) on page 37 for repeatability specifications for each speed.

Navigate: MENU > MEASURE > Speed

Remote Input: Not available

Default: Standard

Speed	Class 1 Laser Models		Class 2 Laser Models	
	Response Time	Response Time in Sync Mode	Response Time	Response Time in Sync Mode
Fast	2 ms	4 ms	2 ms	4 ms
Standard	10 ms (default)	20 ms	5 ms (default)	10 ms
Medium	30 ms	60 ms	15 ms	30 ms
Slow	100 ms	200 ms	50 ms	100 ms

3.8.2 Trigger

The Trigger option sets the advanced measurement that is calculated when a trigger event is detected on the remote input. The analog output updates with the new advanced measurement on each trigger event. To use these Trigger options, the sensor Input Type option must be set to Trigger; see [Input Type](#) on page 27.

Navigate: MENU > MEASURE > Trigger

Remote Input: Not available

Default: Sample

Trigger	Description
Sample	The current distance at the time of the trigger event. (Default) The Analog Output tracks the sample values during the measuring period.
Average	The averaged distance since the last trigger event.
Maximum (Max)	The maximum distance since the last trigger event.
Minimum (Min)	The minimum distance since the last trigger event.
Range	The difference between the maximum and minimum distance since the last trigger event. For additional information on the Range measurement behavior when the maximum or minimum distance is outside of the taught setpoints, see Loss of Signal on page 17.
TrackMax	The maximum distance since the last trigger event. The Analog Output tracks new maximum values during the measurement period.
TrackMin	The minimum distance since the last trigger event. The Analog Output tracks new minimum values during the measurement period.

Figure 26. Sample

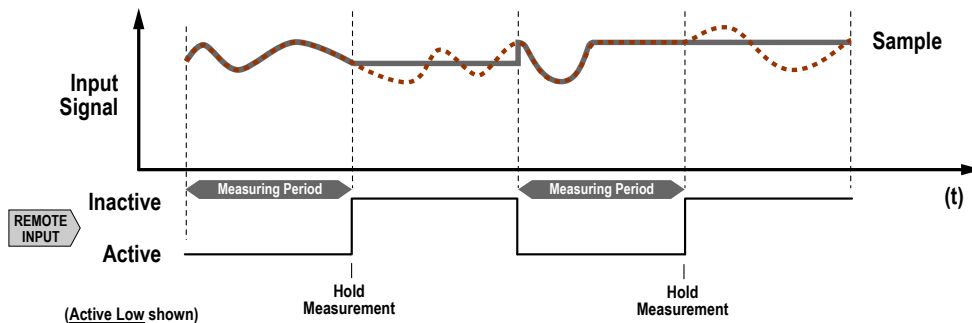

Figure 27. Average

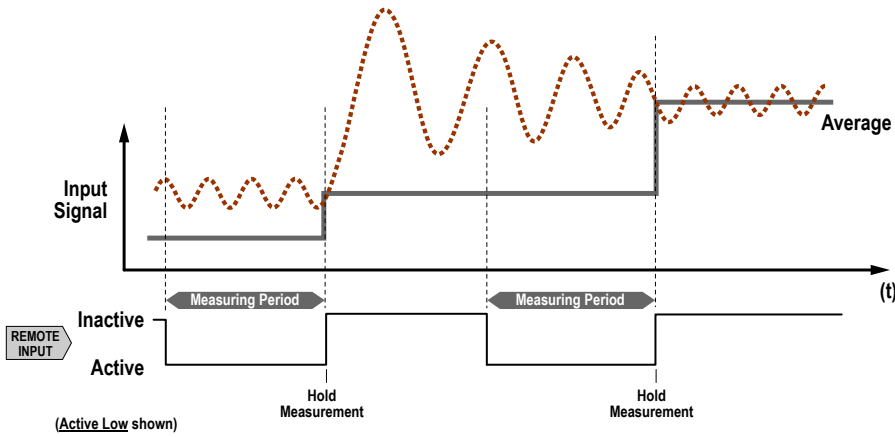

Figure 28. Maximum and Minimum

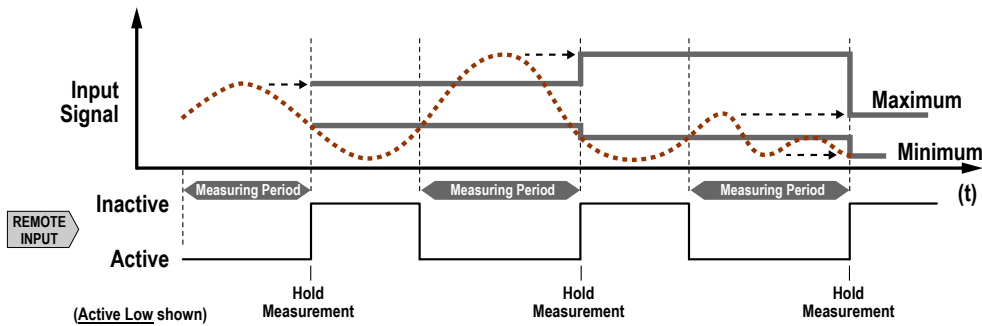

Figure 29. Range

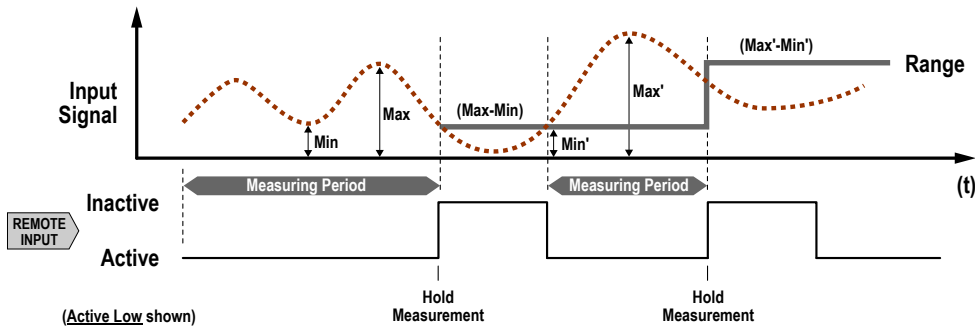
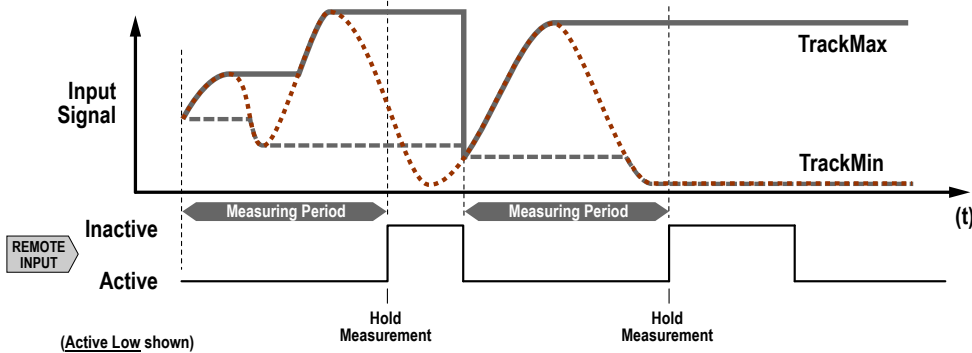

Figure 30. Track Maximum and Track Minimum



3.9 Display Menu (DISPLAY)

Use this menu to view or change the:

- Display units
- Display orientation
- Sleep mode settings

Figure 31. Display Menu Map

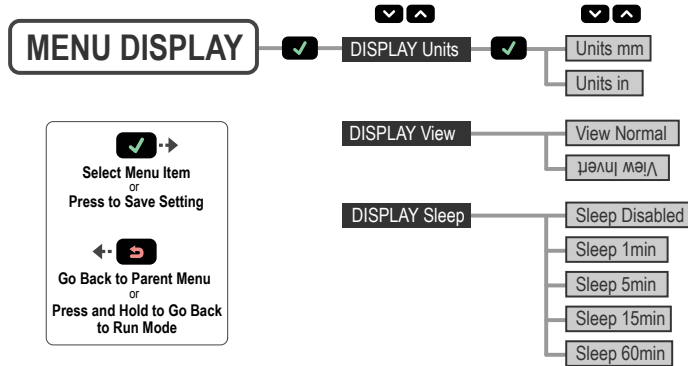

3.9.1 Units

The Units option sets the displayed units to millimeters (mm) or inches (in).

Navigate: MENU > DISPLAY > Units

Remote Input: Not available

Default: mm

3.9.2 View

The View option sets the display orientation of the sensor. Invert the display for applications where the device is mounted upside down. This rotates the display 180°. The Down and Up buttons do not change when the display is inverted.

Navigate: MENU > DISPLAY > View

Remote Input: Not available

Default: Normal

Figure 32. LE550 Normal Display Orientation



Figure 33. LE550 Inverted Display Orientation



3.9.3 Sleep

The Sleep option sets when the display is put to sleep. Four timing options are available: 1, 5, 15, or 60 minutes. Sleep mode is disabled by default. Sleep occurs in Run mode and any menu. To wake the sensor and return to the last viewed mode or menu, press any button.

Navigate: MENU > DISPLAY > Sleep

Remote Input: Not available

Default: Disabled

3.10 Information Menu (INFO)

Figure 34. LE550 Information Menu Map

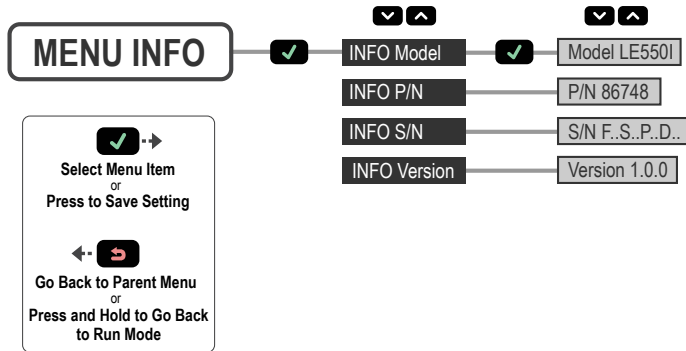

Use this menu to view model, part number (P/N), serial number (S/N), and firmware version (Version) information. Select one of these options to view specific information for your sensor. This information is read-only.

Navigate: MENU > INFO

Remote Input: Not available

3.11 Reset Menu (RESET)

Use this menu to restore the sensor to the factory default settings.

Figure 35. Reset Menu Map

Navigate: MENU > RESET. Select Yes to apply the factory defaults; select No to return to the Reset option without changing any sensor settings.

Remote Input: Eight-pulse the remote input

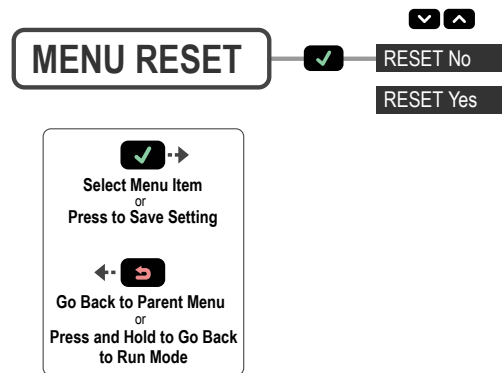

3.11.1 Factory Default Settings

Analog Output Settings	LE250	LE550
Adjust 4 mA (0 V)	100 mm	100 mm
Adjust 20 mA (10 V)	400 mm	1000 mm
Loss of Signal	3.5 mA (0 V)	
Slope	Positive	
Window Size	50 mm	300 mm

Discrete Output Settings	LE250	LE550
Adjust Switch Point One	100 mm	100 mm
Adjust Switch Point Two	400 mm	1000 mm
Mode	Wnd 	
Polarity	PNP	
Timer	0 ms for all timers	
Window Size	50 mm	300 mm

Input Settings	LE250 and LE550
Input Active	Low
Input Type	Teach

Measure Settings	LE250 and LE550
Speed	Standard
Trigger	Sample

Display Settings	LE250 and LE550
Sleep	Disabled
Units	mm
View	Normal

4 Sync Master/Slave

Two LE250/550 Laser sensors may be used together in a single sensing application. To eliminate crosstalk between the two sensors, configure one sensor to be the master and one to be the slave. In this mode, the sensors alternate taking measurements and the response speed doubles.

1. Configure the first sensor as the master; navigate: **MENU > INPUT > Type > SyncMstr.**
2. Configure the second sensor as the slave; navigate: **MENU > INPUT > Type > SyncSlve.**
3. Connect the gray (input) wires of the two sensors together.

If using a combination of Class 1 and Class 2 laser models, the Class 1 laser model must be used as the master.

5 Additional Remote TEACH Procedures

5.1 TEACH Analog Output and Discrete Output Switch Points Together

Use the following procedure to teach identical Analog Output and Discrete Output switch points at the same time using the remote input. This feature is not available using the buttons.

1. Access the TEACH mode.

Action		Result
Single-pulse the remote input.		"RMT TCH" and the current measurement value display.

2. Present the target.

Action		Result
Present the switch point one target.		"RMT TCH" and the target's measurement value display.

3. TEACH the sensor.

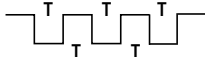
Action		Result
Three-pulse the remote input.		<p>"TchA&D1 Teaching" displays while the sensor is being taught.</p> <p>TEACH Accepted</p> <p>The new value displays on the second line of the display, flashes, and then "TchA&D2" and the current measurement value display.</p> <p>TEACH Not Accepted</p> <p>"FAIL" flashes, the sensor returns to step 2, and "RMT TCH" displays.</p>

4. Present the target.

Action		Result
Present the switch point two target.		"TchA&D2" and the target's measurement value display.

5. TEACH the sensor.

Action		Result
Single-pulse the remote input.		<p>"TchA&D2 Teaching" displays while the sensor is being taught.</p> <p>TEACH Accepted</p> <p>The new value displays on the second line of the display, flashes, and the sensor returns to Run mode.</p> <p>TEACH Not Accepted</p> <p>"FAIL" flashes, the sensor returns to step 2, and "RMT TCH" displays.</p>

5.2 TEACH Analog Output and Discrete Output Midpoints Together

Use the following procedure to teach an identical Analog Output 12 mA (5 V) point and Discrete Output midpoint (switch point) at the same time using the remote input. This feature is not available using the buttons. Note that if the window sizes were set independently (using the buttons), the windows taught using the following procedure could be different.

1. Access the TEACH mode.

Action		Result
Single-pulse the remote input.		"RMT TCH" and the current measurement value display.

2. Present the target.

Action	Result
Present the midpoint (switch point) target.	"RMT TCH" and the target's measurement value display.

3. TEACH the sensor.

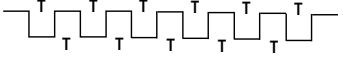
Action	Result
<p>Six-pulse the remote input.</p> 	<p>"TchA&D Teaching" displays while the sensor is being taught.</p> <p>TEACH Accepted</p> <p>The new value displays on the second line of the display, flashes, and the sensor returns to Run mode.</p> <p>TEACH Not Accepted</p> <p>"FAIL" flashes, the sensor returns to step 2, and "RMT TCH" displays.</p>

6 Specifications

Supply Voltage (Vcc)

12 V DC to 30 V DC

Power and Current Consumption, exclusive of load

Normal Run Mode: 1.7 W, Current consumption < 70 mA at 24 V DC

Supply Protection Circuitry

Protected against reverse polarity and transient overvoltages

Output Configuration

Analog output: 4 to 20 mA or 0 to 10 V, depending on model
Discrete output rating: Discrete NPN/PNP is user-configurable

Output Ratings

Discrete Output: 100 mA maximum (protected against continuous overload and short circuit)

OFF-state leakage current—PNP: < 10 µA at 30 V

OFF-state leakage current—NPN: < 200 µA at 30 V

Output saturation voltage—PNP outputs: < 3 V at 100 mA

Output saturation voltage—NPN outputs: < 1.6 V at 100 mA

Analog current output (LE...I Models): 1 kΩ max. @ 24 V; max. load resistance = [(Vcc-4.5)/0.02 Ω]

Analog voltage output (LE...U Models): 2.5 kΩ min. load resistance

Remote Input

Allowable Input Voltage Range: 0 to Vcc

Active Low (internal weak pullup—sinking current):

- High State > 4.3 V at 740 µA max.
- Low State < 1.3 V at 800 µA max.

Active High (internal weak pulldown—sourcing current):

- High State > 4.3 V at 1.7 mA max.
- Low State < 1.3 V at 1.6 mA max.

Analog Resolution

LE250: 100 mm to 250 mm: Less than 0.02 mm

LE250: 250 mm to 400 mm: Less than 0.2 mm

LE550: 100 mm to 600 mm: Less than 0.5 mm

LE550: 600 mm to 1000 mm: Less than 1 mm

Analog Linearity

LE250: Linearity is the less of Accuracy or 0.3% of full scale range (± 0.9 mm) at any given distance

LE550: Linearity is the lesser of Accuracy or 0.5% of full scale range (± 4.5 mm) at any given distance

Typical Beam Spot Size ¹

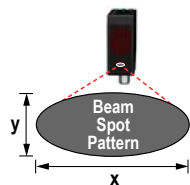

	Distance (mm)					
	LE250 Models			LE550 Models		
	100	250	400	100	550	1000
x	3.2	2.1	1.2	8.4	10.5	12.1
y	2.2	1.5	0.9	3.5	4.2	4.9

Sensing Beam

Class 2 laser models: visible red, 650 nm

Class 1 laser models: visible red, 650 nm

Sensing Range

LE250: 100 mm (3.94 in) to 400 mm (15.75 in)

LE550: 100 mm (3.94 in) to 1000 mm (39.37 in)

Delay at Power Up

2 s

Measurement/Output Rate

Class 2 laser models: < 1 ms

Class 1 laser models (fast): < 1 ms

Class 1 laser models (std/med/slow): < 2 ms

Ambient Light Immunity

Class 2 laser models: > 10,000 lux

Class 1 laser models: > 5,000 lux

Minimum Window Size, Analog and Discrete

LE250: 1 mm (0.039 in)

LE550: 10 mm (0.39 in)

Boresighting

LE250: 4 mm radius at 400 mm

LE550: 1 cm radius at 1 m

Maximum Torque

2 N·m (17.7 in-lbs)

Repeatability

See *Performance Curves*

Temperature Effect

See *Performance Curves*

Accuracy

See *Performance Curves*

Construction

Housing: die-cast zinc

Window: acrylic

Vibration/Mechanical Shock

All models meet Mil. Std. 202 G requirements method 201A.

Also meets IEC 60947-5-2.

Response Time

	Class 1 Laser Models	Class 2 Laser Models
Fast ²	2 ms	2 ms
Standard	10 ms	5 ms
Medium	30 ms	15 ms
Slow	100 ms	50 ms

¹ Beam spot size is calculated as 1.6 times the D4σ measured value

² Response time for lateral entry of object into measurement range < 5 ms

Environmental Rating

IP67, NEMA 6

Operating Conditions

Temperature: -20 °C to +55 °C (-4 °F to +131°F)

Humidity: 90% at +55 °C maximum relative humidity (non-condensing)

Storage Temperature

-30 °C to +65 °C (-22 °F to +149 °F)

Application Note

For optimum performance, allow 10 minutes for the sensor to warm up

Certifications



UL Environmental Rating: Type 1

Required Overcurrent Protection



WARNING: Electrical connections must be made by qualified personnel in accordance with local and national electrical codes and regulations.

Overcurrent protection is required to be provided by end product application per the supplied table. Overcurrent protection may be provided with external fusing or via Current Limiting, Class 2 Power Supply. Supply wiring leads < 24 AWG shall not be spliced. For additional product support, go to www.bannerengineering.com.

Supply Wiring (AWG)	Required Overcurrent Protection (Amps)
20	5.0
22	3.0
24	2.0
26	1.0
28	0.8
30	0.5

6.1 Performance Curves

LE250 Models

LE550 Models

Figure 36. Repeatability (90% to 6% reflectance)

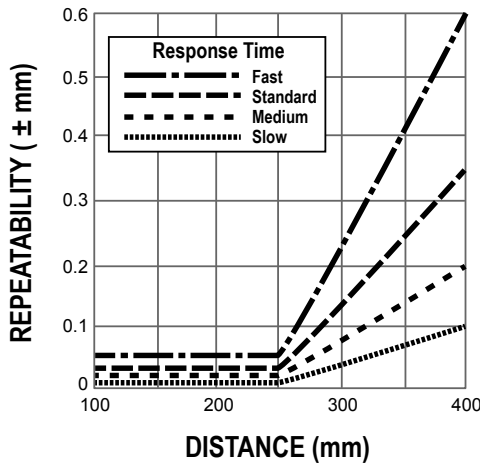
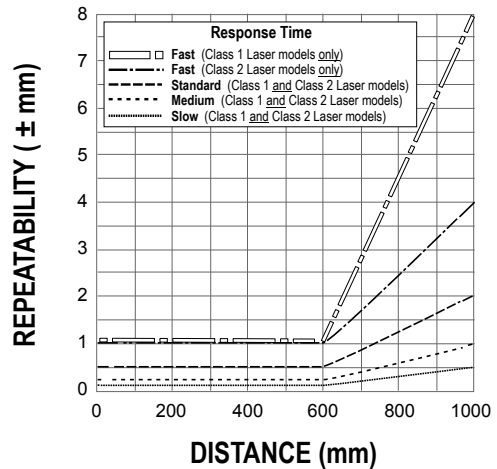

Figure 37. Repeatability (90% to 6% reflectance)



LE250 Models

LE550 Models

Figure 38. Accuracy (90% to 6% reflectance)

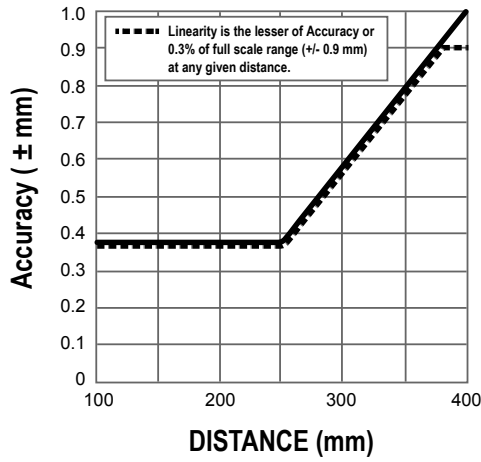

Figure 39. Accuracy (90% to 6% reflectance)

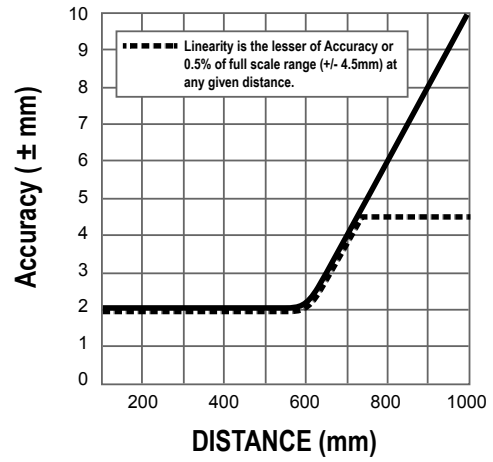

Figure 40. Temperature Effect

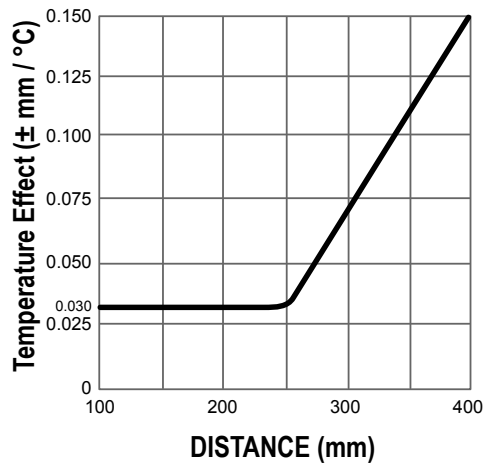
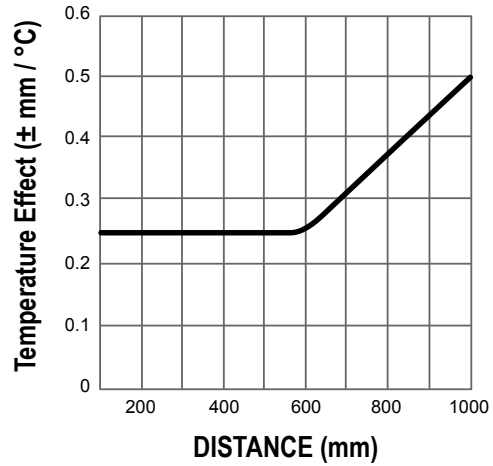
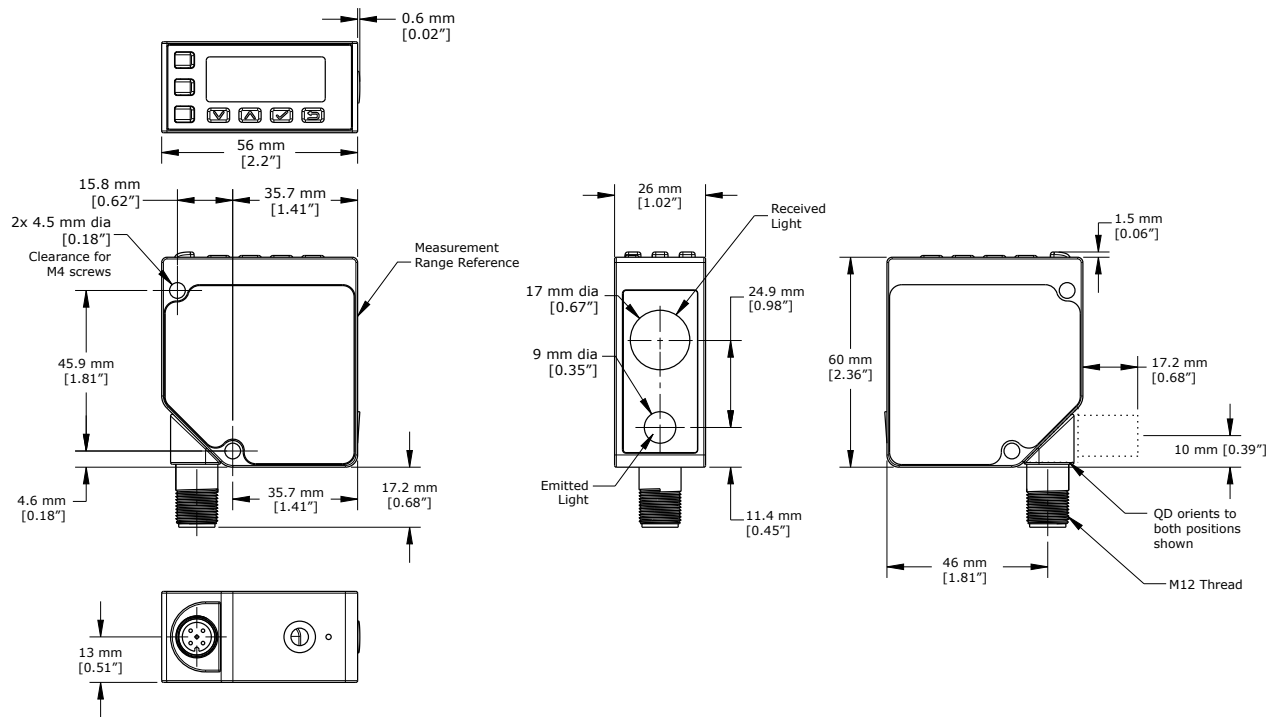

Figure 41. Temperature Effect



6.2 Dimensions

All measurements are listed in millimeters [inches], unless noted otherwise.



7 Troubleshooting

Message/Indicator	Description	Resolution
Fail/ Min Wnd OutRnge	The minimum window size is 1 mm for the LE250 models and 10 mm for the LE550 models. One point of the adjusted or taught window is out of range.	The sensor automatically returns to the previous setting.
Fail/ Out of Range	The TEACH failed, the target is out of range. The target might have moved out of range after the TEACH process began.	TEACH the switch point within the measurement range.
Fail/ Wnd out of Range	The window TEACH failed. <ul style="list-style-type: none"> The window is out of the measurement range. The target might have moved out of range after the TEACH process began. The window is too large. 	TEACH the window within the measurement range.
MIN Wnd xx mm (xx in)	The adjusted or taught window size is too small; the minimum window size is displayed.	The sensor automatically adjusts the window size to maintain the minimum window size and completes the adjust or TEACH operation.
OutRnge	The target is out of range, too dark, or the sensor is not measuring.	Move the target within the measurement range.
Power LED is flashing green	The sensor input is set to laser enable and the input is not active.	See Input Type on page 27.
Power LED is flashing red	The laser shut off, the Power LED flashes red and Output LEDs flash amber at 1Hz, and the display is blank. The laser has experienced a fault.	Contact Banner Engineering to resolve.
SPtx < Near or SPtx > Far	One of the switch points is located outside the sensor's range, either too close to the sensor or too far away.	The sensor automatically adjusts the invalid switch point to the end of range. Reduce the window size or change the teach location so both switch points are inside the valid range.
Type Sync Slave	The slave mode sensor does not see the master's pulse.	Verify the master mode sensor is configured and functioning properly. Check the input wire connection between the master and slave.

8 Sensor Menu Full Map (LE550 Analog/Discrete Models)

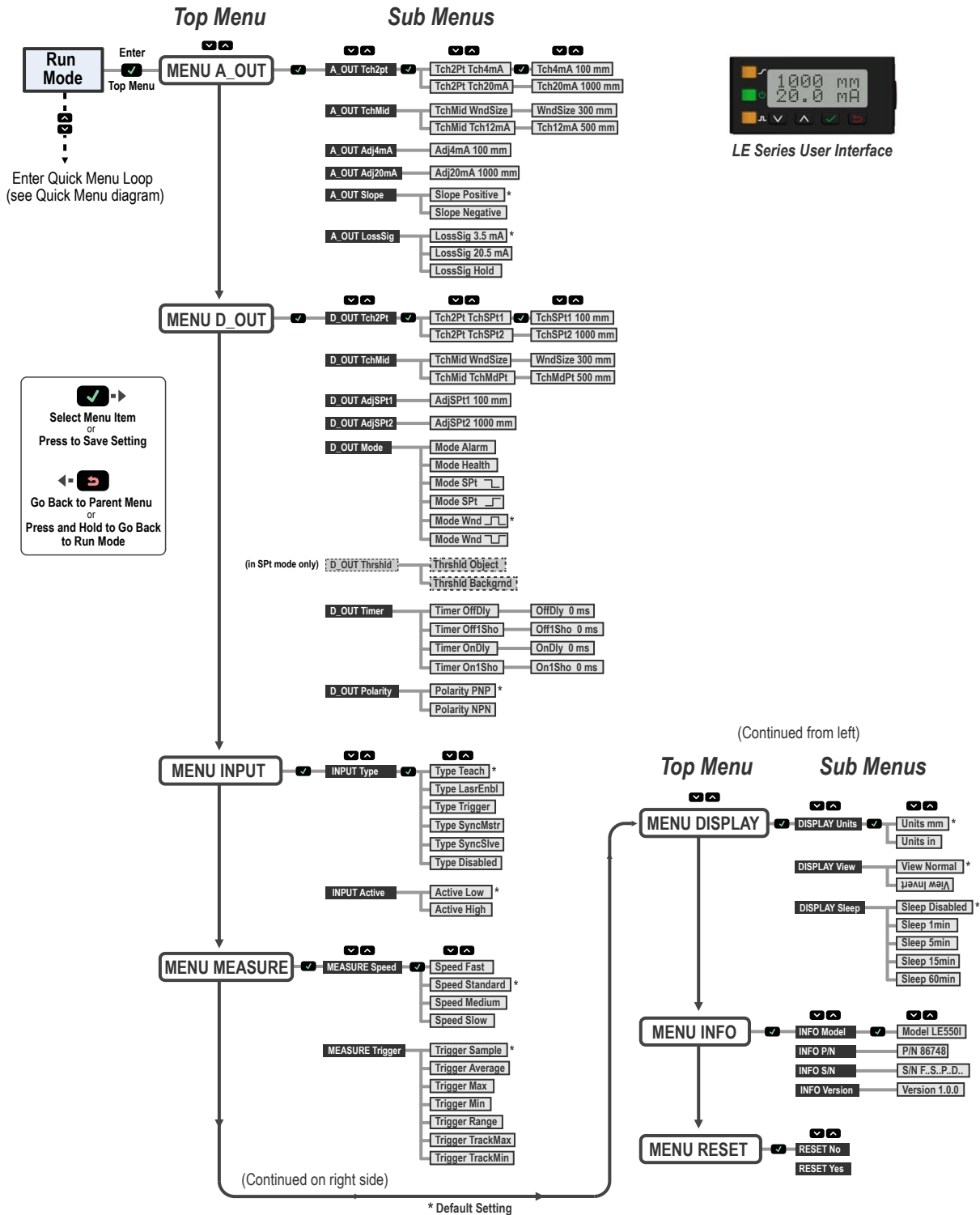

Note: See [Remote Input](#) on page 10 for remote input options.

9 Accessories

9.1 Cordsets

All measurements are listed in millimeters, unless noted otherwise.

5-Pin Threaded M12 Cordsets with Shield—Single Ended				
Model	Length	Style	Dimensions	Pinout (Female)
MQDEC2-506	2 m (6.56 ft)	Straight		<p>1 = Brown 2 = White 3 = Blue 4 = Black 5 = Gray</p>
MQDEC2-515	5 m (16.4 ft)			
MQDEC2-530	9 m (29.5 ft)			
MQDEC2-550	15 m (49.2 ft)			
MQDEC2-506RA	2 m (6.56 ft)	Right-Angle		
MQDEC2-515RA	5 m (16.4 ft)			
MQDEC2-530RA	9 m (29.5 ft)			
MQDEC2-550RA	15 m (49.2 ft)			

9.2 Brackets

All measurements are listed in millimeters, unless noted otherwise.

SMBLEU

- Enclosed bracket
- 16 gauge stainless steel

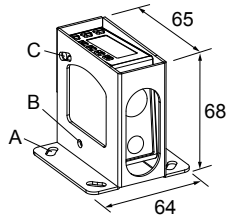

Hole size: A = \varnothing 5 with 20° adjustability, B = \varnothing 4.5, C = \varnothing 4.5 with 10° adjustability

SMBLEL

- Right-angle bracket
- 12 gauge stainless steel

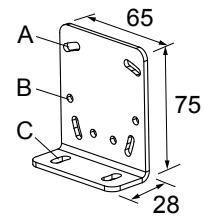

Hole size: A = \varnothing 4.5 with 20° adjustability, B = \varnothing 4.5, C = \varnothing 5.7 with 20° adjustability

SMBLEFA

- Swivel plate bracket
- 12 gauge stainless steel

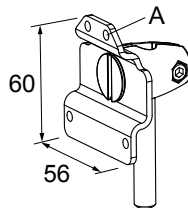

Hole size: A = 4x \varnothing 4.5

SMBAMSLTFP

- AMS mounting pattern
- 12 gauge stainless steel

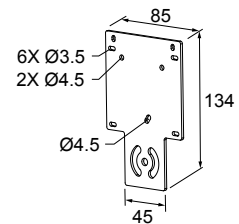

SMBAMSLEIP

- Includes the mounting plate and two protective windows
- 90 plus degree rotation
- Window frames are black anodized aluminum; mounting plate is stainless steel
- The mounting plate, SMBAMSLTFP, can be ordered separately
- The replacement window, RWAMSLE, can be ordered separately

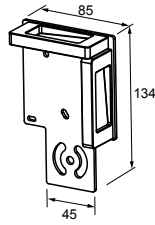

10 Banner Engineering Corp Limited Warranty

Banner Engineering Corp. warrants its products to be free from defects in material and workmanship for one year following the date of shipment. Banner Engineering Corp. will repair or replace, free of charge, any product of its manufacture which, at the time it is returned to the factory, is found to have been defective during the warranty period. This warranty does not cover damage or liability for misuse, abuse, or the improper application or installation of the Banner product.

THIS LIMITED WARRANTY IS EXCLUSIVE AND IN LIEU OF ALL OTHER WARRANTIES WHETHER EXPRESS OR IMPLIED (INCLUDING, WITHOUT LIMITATION, ANY WARRANTY OF MERCHANTABILITY OR FITNESS FOR A PARTICULAR PURPOSE), AND WHETHER ARISING UNDER COURSE OF PERFORMANCE, COURSE OF DEALING OR TRADE USAGE.

This Warranty is exclusive and limited to repair or, at the discretion of Banner Engineering Corp., replacement. **IN NO EVENT SHALL BANNER ENGINEERING CORP. BE LIABLE TO BUYER OR ANY OTHER PERSON OR ENTITY FOR ANY EXTRA COSTS, EXPENSES, LOSSES, LOSS OF PROFITS, OR ANY INCIDENTAL, CONSEQUENTIAL OR SPECIAL DAMAGES RESULTING FROM ANY PRODUCT DEFECT OR FROM THE USE OR INABILITY TO USE THE PRODUCT, WHETHER ARISING IN CONTRACT OR WARRANTY, STATUTE, TORT, STRICT LIABILITY, NEGLIGENCE, OR OTHERWISE.**

Banner Engineering Corp. reserves the right to change, modify or improve the design of the product without assuming any obligations or liabilities relating to any product previously manufactured by Banner Engineering Corp. Any misuse, abuse, or improper application or installation of this product or use of the product for personal protection applications when the product is identified as not intended for such purposes will void the product warranty. Any modifications to this product without prior express approval by Banner Engineering Corp will void the product warranties. All specifications published in this document are subject to change; Banner reserves the right to modify product specifications or update documentation at any time. Specifications and product information in English supersede that which is provided in any other language. For the most recent version of any documentation, refer to: www.bannerengineering.com.

For patent information, see www.bannerengineering.com/patents.