

## DESCRIPTION

The MP5087A is a load switch, designed to provide 7A load protection covering 0.5V to 5.5V voltage range. With low  $R_{DS(on)}$  in tiny package, MP5087A provides very high efficiency and space-saving solution for notebook, tablet and other portable applications.

With the soft start function, the MP5087A can avoid inrush current during circuit start up. The MP5087A also provides other features, like power good, output discharge function, OCP and thermal shutdown.

The maximum load at the output (source) is current limited. This is accomplished by utilizing a sense FET topology. The magnitude of the current limit is controlled by an external resistor from ILIM pin to ground.

This device comes in a tiny 2x2mm QFN12 package.

## FEATURES

- Integrated 10m $\Omega$  Low  $R_{DS(on)}$  FET
- Adjustable Start Up Slew Rate
- Wide  $V_{IN}$  Range: 0.5V to 5.5V
- <1 $\mu$ A Shutdown Current
- Programmable 7A Current Limit Range
- Output Discharge Function
- Enable Pin
- Push-pull PG Indicator for  $V_{IN}>3V$
- <200ns Short-Circuitry Response Protection
- Thermal Protection
- Small QFN-12 (2mmx2mm) Package

## APPLICATIONS

- Notebook and Tablet Computers
- Portable Devices
- Solid State Drivers
- Handheld Devices

All MPS parts are lead-free and adhere to the RoHS directive. For MPS green status, please visit MPS website under Quality Assurance.

"MPS" and "The Future of Analog IC Technology" are Registered Trademarks of Monolithic Power Systems, Inc.

## TYPICAL APPLICATION

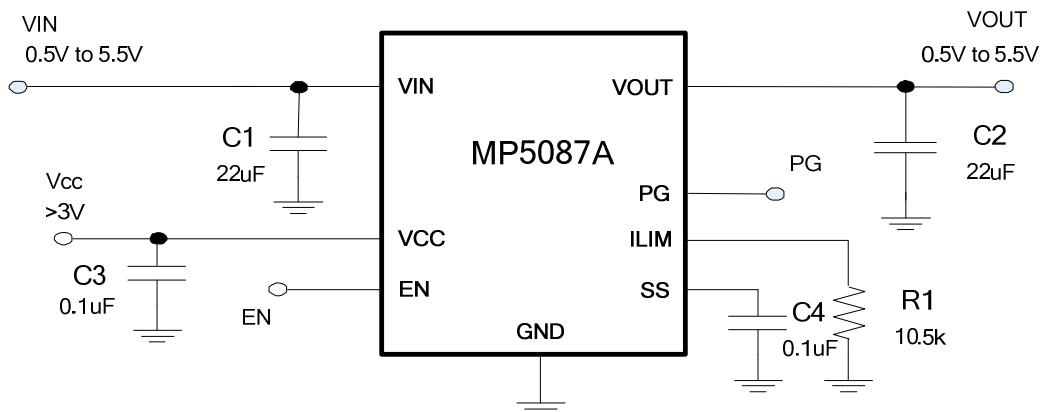

## ORDERING INFORMATION

Part Number*	Package	Top Marking
MP5087AGG	QFN-12 (2mmx2mm)	See Below

\* For Tape & Reel, add suffix -Z (e.g. MP5087AGG-Z);

## TOP MARKING

—  
**CHY**  
**LLL**

CH: product code of MP5087AGG;  
 Y: year code;  
 LLL: lot number;

## PACKAGE REFERENCE

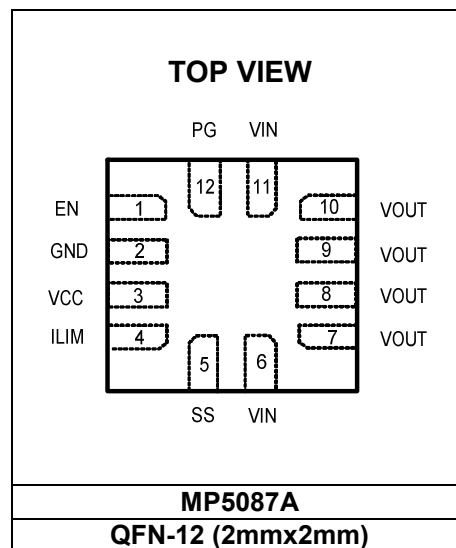

**ABSOLUTE MAXIMUM RATINGS** <sup>(1)</sup>

$V_{IN}$ .....	-0.3V to +6.5V
$V_{CC}$ .....	-0.3V to +6.5V
$V_{OUT}$ .....	-0.3V to +6.5V
EN, SS, ILIM.....	-0.3V to $V_{CC}+0.3V$
Junction Temperature.....	150°C
Lead Temperature.....	260°C
Continuous Power Dissipation <sup>(2)</sup>	
QFN-12 (2mmx2mm).....	1.6W

**Recommended Operating Conditions** <sup>(3)</sup>

Supply Voltage $V_{IN}$ .....	0.5V to 5.5V
Supply Voltage $V_{CC}$ .....	3V to 5.5V
Output Voltage $V_{OUT}$ .....	0.5V to 5.5V
Operating Junction Temp.....	-40°C to +125°C

<b>Thermal Resistance</b> <sup>(4)</sup>	$\theta_{JA}$	$\theta_{JC}$	
QFN-12 (2mmx2mm).....	80	16	°C/W

**Notes:**

- 1) Exceeding these ratings may damage the device.
- 2) The maximum allowable power dissipation is a function of the maximum junction temperature  $T_J$  (MAX), the junction-to-ambient thermal resistance  $\theta_{JA}$ , and the ambient temperature  $T_A$ . The maximum allowable continuous power dissipation at any ambient temperature is calculated by  $P_D$  (MAX) =  $(T_J$  (MAX)- $T_A$ )/ $\theta_{JA}$ . Exceeding the maximum allowable power dissipation will cause excessive die temperature, and the regulator will go into thermal shutdown. Internal thermal shutdown circuitry protects the device from permanent damage.
- 3) The device is not guaranteed to function outside of its operating conditions.
- 4) Measured on JESD51-7, 4-layer PCB.

## ELECTRICAL CHARACTERISTICS

$V_{IN} = 3.6V$ ,  $V_{CC} = 3.6V$ ,  $T_A = 25^\circ C$ , unless otherwise noted.

Parameters	Symbol	Condition	Min	Typ	Max	Units
<b>Input and Supply Voltage Range</b>						
Input Voltage	$V_{IN}$		0.5		5.5	V
Supply Voltage	$V_{CC}$		3		5.5	V
<b>Supply Current</b>						
Off State Leakage Current	$I_{OFF}$	$V_{IN}=5V$ , $EN=0$			1	$\mu A$
$V_{CC}$ Standby Current	$I_{STBY}$	$V_{CC}=5V$ , $EN=0$		0.1	1	$\mu A$
		$V_{CC}=5V$ , Enable, No load		220	330	
<b>Power FET</b>						
ON Resistance	$R_{DS(on)}$	$V_{CC}=5.0V$		10		m $\Omega$
		$V_{CC}=3.3V$		12		
<b>Thermal Shutdown and Recovery</b>						
Shutdown Temperature <sup>(5)</sup>	$T_{STD}$			155		$^\circ C$
Hysteresis <sup>(5)</sup>	$T_{HYS}$			30		$^\circ C$
<b>Under Voltage Protection</b>						
$V_{CC}$ Under Voltage Lockout Threshold	$V_{CC\_UVLO}$	UVLO Rising Threshold		2.6	2.8	V
UVLO Hysteresis	$V_{UVLO\_HYS}$			200		mV
<b>Soft Start</b>						
SS pull-up current	$I_{SS}$			9		$\mu A$
<b>Enable</b>						
EN Rising Threshold	$V_{ENH}$		1.3	1.5	1.7	V
EN Hysteresis	$V_{ENHYS}$			400		mV
<b>ILIM</b>						
Current Limit	$I_{OUT}$	$R_{LIM}=50k\Omega$ . Ramp $I_{OUT}$ record peak current limit	1.54		1.74	A
<b>PG</b>						
$V_{IN}$ Upper threshold	$V_{INTH}$		2.8	2.925	2.97	V
Hysteresis on $V_{IN}$ pin	$V_{HYS}$			100		mV
Power Good Rising Delay	$T_{PG\_D\_Rise}$			100		$\mu s$
Power Good Deglitch Delay	$T_{PG\_D\_Fall}$				5	$\mu s$
Power Good High	$V_{PG\_H}$	$V_{CC}=3.3V$	3.2			V
Power Good Low	$V_{PG\_L}$	Sink 1mA			0.4	V
<b>Discharge Resistance</b>						
Resistance	$R_{DIS}$			200		$\Omega$

### Notes:

5) Guarantee by Characterization-Not Production tested.

## TYPICAL PERFORMANCE CHARACTERISTICS

$V_{IN} = 3.6V$ ,  $V_{CC} = 3.6V$ ,  $R_{LIM} = 10.5k\Omega$ ,  $T_A = 25^\circ C$ , unless otherwise noted.

Vcc Standby Current vs. Vcc

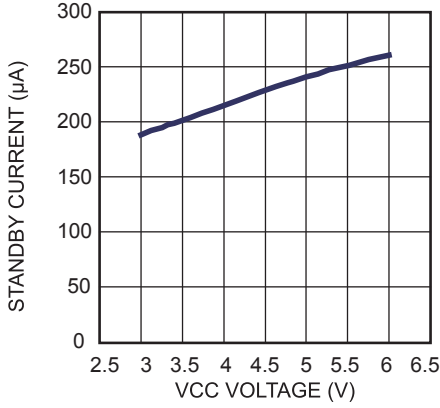

Vcc Standby Current vs. Temperature

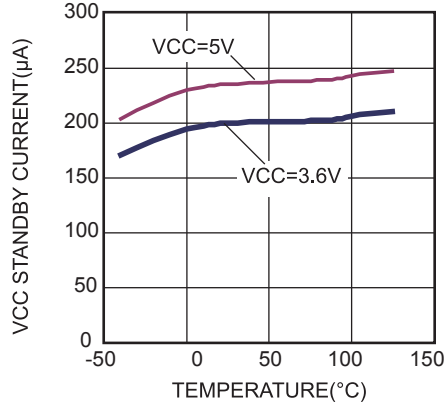

Disabled Supply Current vs. Input Voltage

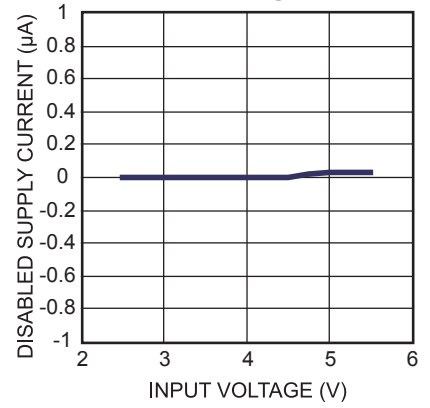

VIN UVLO Rising Threshold vs. Temperature

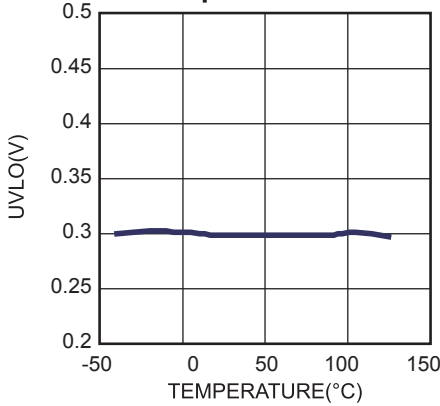

EN Rising Threshold vs. Temperature

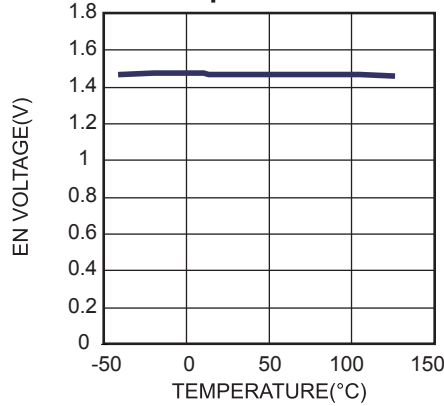

EN Falling Threshold vs. Temperature

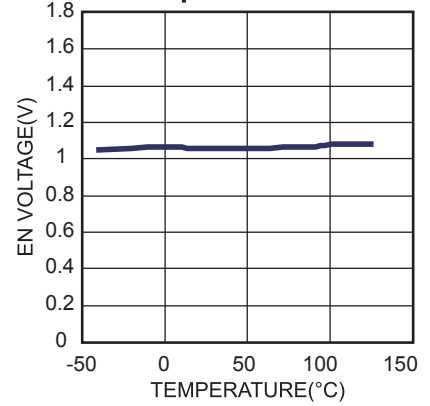

$R_{DS(on)}$  vs. Vcc

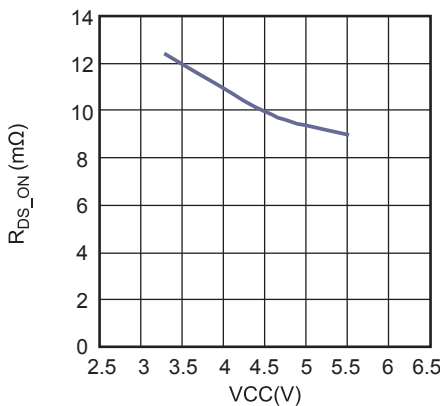

$R_{DS(on)}$  vs. Temperature

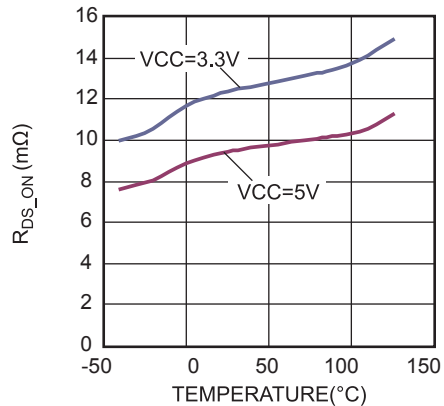

Current Limit vs.  $R_{LIM}$

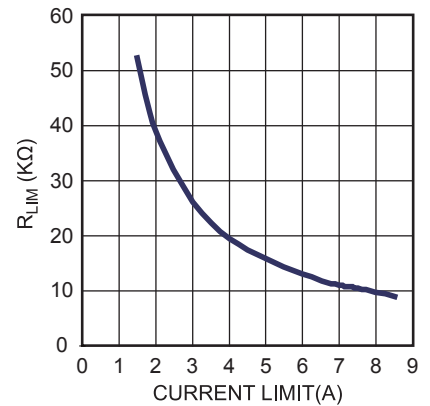

## TYPICAL PERFORMANCE CHARACTERISTICS *(continued)*

$V_{IN} = 3.6V$ ,  $V_{CC} = 3.6V$ ,  $R_{LIM} = 10.5k\Omega$ ,  $T_A = 25^\circ C$ , unless otherwise noted.

$I_{LIM}$  vs. Temperature

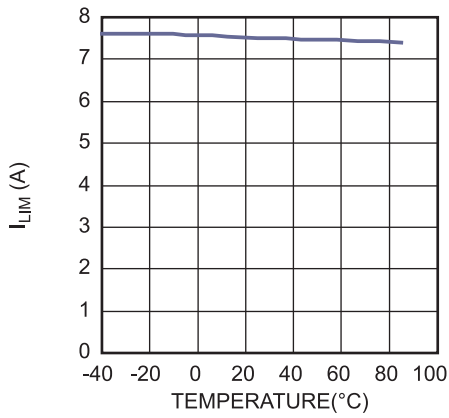

Soft-Start vs. Cap

$V_{IN} = 5V$ ,  $V_{CC} = 3.6V$

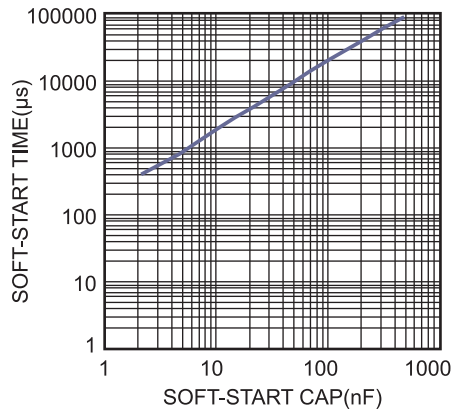

Case Temperature Rise vs. Output Current

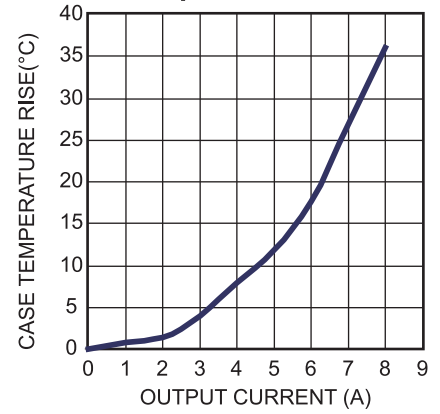

## TYPICAL PERFORMANCE CHARACTERISTICS (continued)

$V_{IN} = 3.6V$ ,  $V_{CC} = 3.6V$ ,  $R_{LIM} = 10.5k\Omega$ ,  $T_A = 25^\circ C$ , unless otherwise noted.

### Enable Startup

$V_{IN} = 3.6V$ ,  $V_{CC} = 3.6V$ , No Load

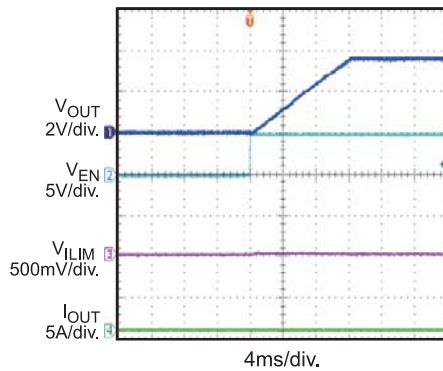

### Enable Startup

$V_{IN} = 3.6V$ ,  $V_{CC} = 3.6V$ , 7A Load

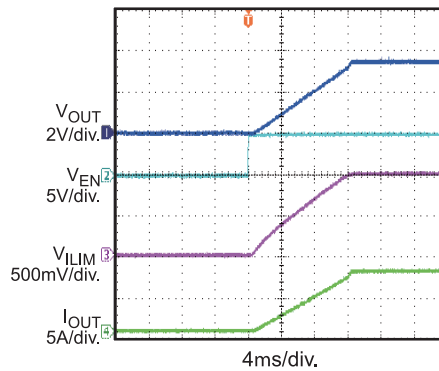

### Enable Shutdown

$V_{IN} = 3.6V$ ,  $V_{CC} = 3.6V$ , No Load

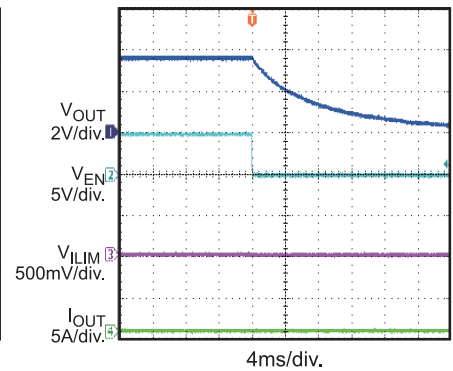

### Enable Shutdown

$V_{IN} = 3.6V$ ,  $V_{CC} = 3.6V$ , 7A Load

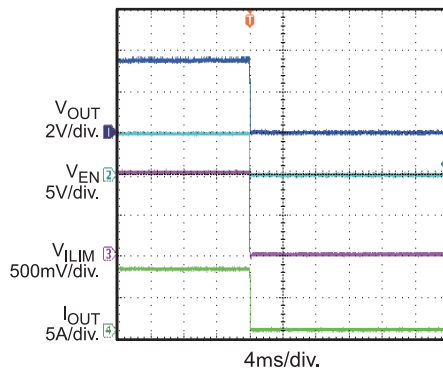

### Power Up

$V_{IN} = 3.6V$ ,  $V_{CC} = 3.6V$ , No Load

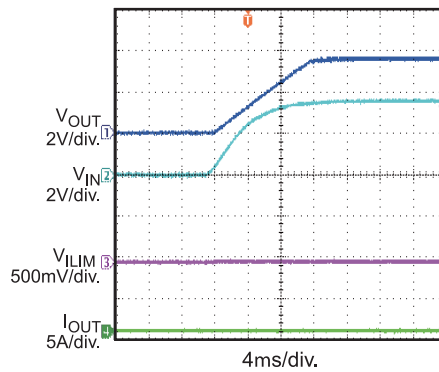

### Power Up

$V_{IN} = 3.6V$ ,  $V_{CC} = 3.6V$ , 7A Load

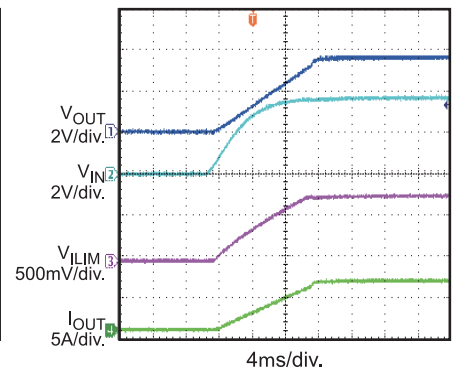

### Power Down

$V_{IN} = 3.6V$ ,  $V_{CC} = 3.6V$ , No Load

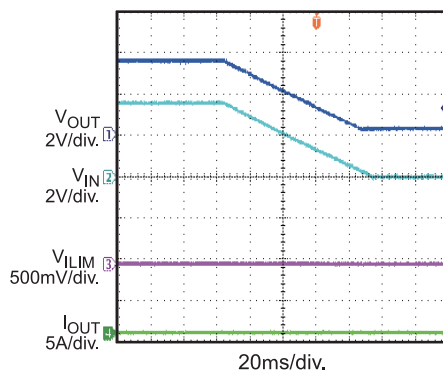

### Power Good

$V_{IN} = 3.6V$ ,  $V_{CC} = 3.6V$ , No Load

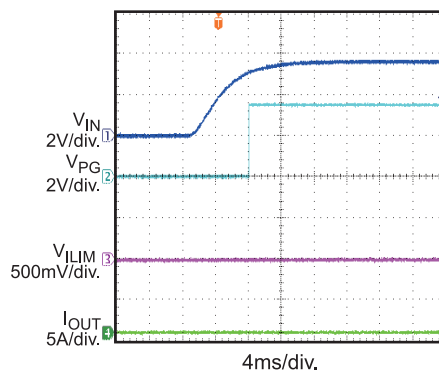

### Power Good

$V_{IN} = 3.6V$ ,  $V_{CC} = 3.6V$ , 7A Load

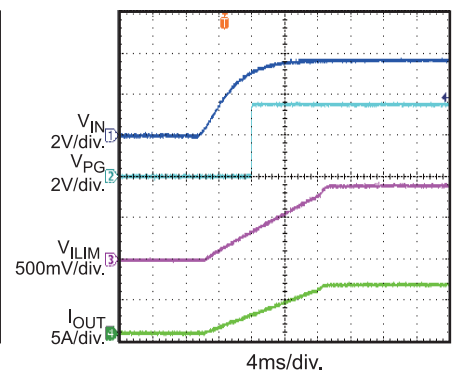

## TYPICAL PERFORMANCE CHARACTERISTICS (continued)

$V_{IN} = 3.6V$ ,  $V_{CC} = 3.6V$ ,  $R_{LIM} = 10.5k\Omega$ ,  $T_A = 25^\circ C$ , unless otherwise noted.

### Power Good

$V_{IN} = 3.6V$ ,  $V_{CC} = 3.6V$ , No Load

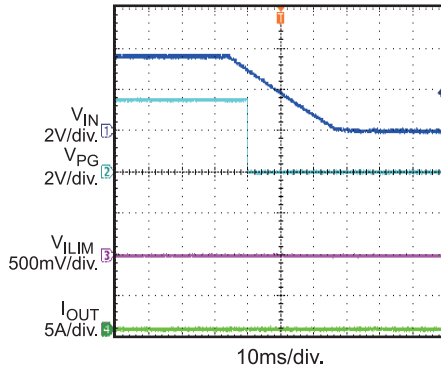

### Power Good

$V_{IN} = 3.6V$ ,  $V_{CC} = 3.6V$ , 7A Load

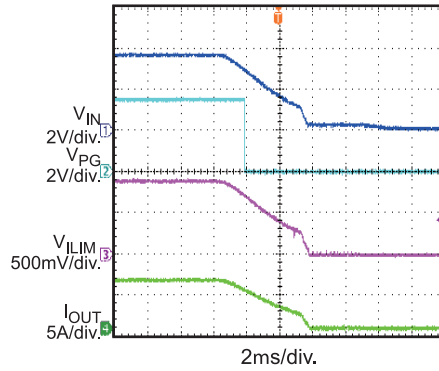

### Steady State

$V_{IN} = 3.6V$ ,  $V_{CC} = 3.6V$ , 7A Load

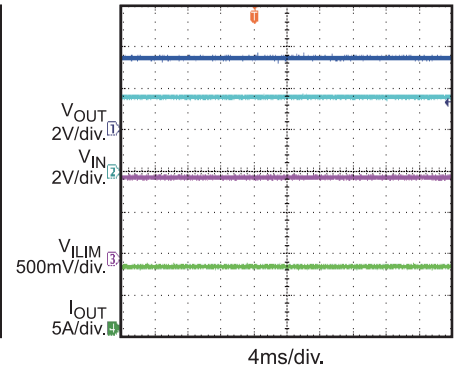

### Load Transient Response

$V_{IN} = 5V$ ,  $V_{CC} = 3.3V$ ,  $I_{OUT} = 0A-7A$

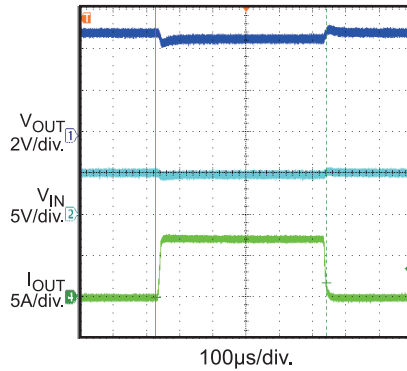

### SCP Enter

$V_{IN} = 5V$ ,  $V_{CC} = 3.3V$ ,  $R_{LIMIT} = 10.5k\Omega$

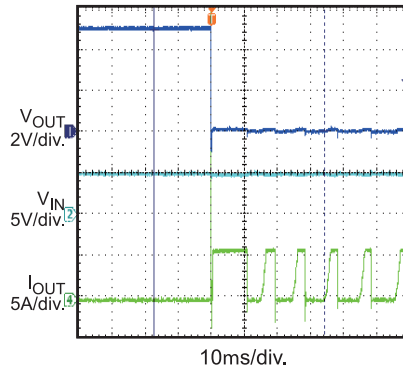

### SCP Steady State

$V_{IN} = 5V$ ,  $V_{CC} = 3.3V$ ,  $R_{LIMIT} = 10.5k\Omega$

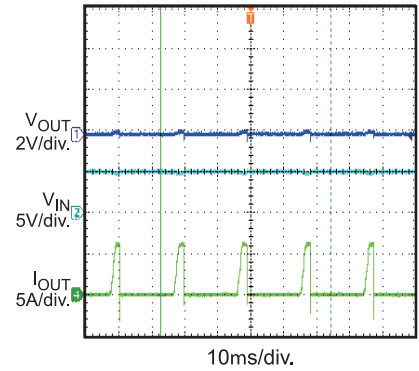

### SCP Recover

$V_{IN} = 5V$ ,  $V_{CC} = 3.3V$ ,  $R_{LIMIT} = 10.5k\Omega$

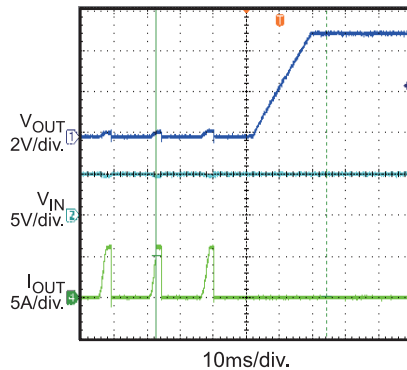



## PIN FUNCTIONS

QFN-12 (2mmx2mm) Pin #	Name	Description
1	EN	Enable Input. Pulling this pin below the specified threshold shuts the chip down.
2	GND	Ground.
3	VCC	Supply Voltage to the Control Circuitry.
4	ILIM	Output Current Limit Configure. Place a resistor to ground to set the overload current limit level.
5	SS	Soft Start Pin. An external capacitor connected to this pin sets the slew rate of the output voltage soft start period.
6, 11	VIN	Input Power Supply.
7, 8, 9, 10	VOUT	Output to the Load.
12	PG	Power Good Pin. Push-Pull output to monitor input voltage. If VIN pin voltage is higher than 3V, the PG voltage is high.

## BLOCK DIAGRAM

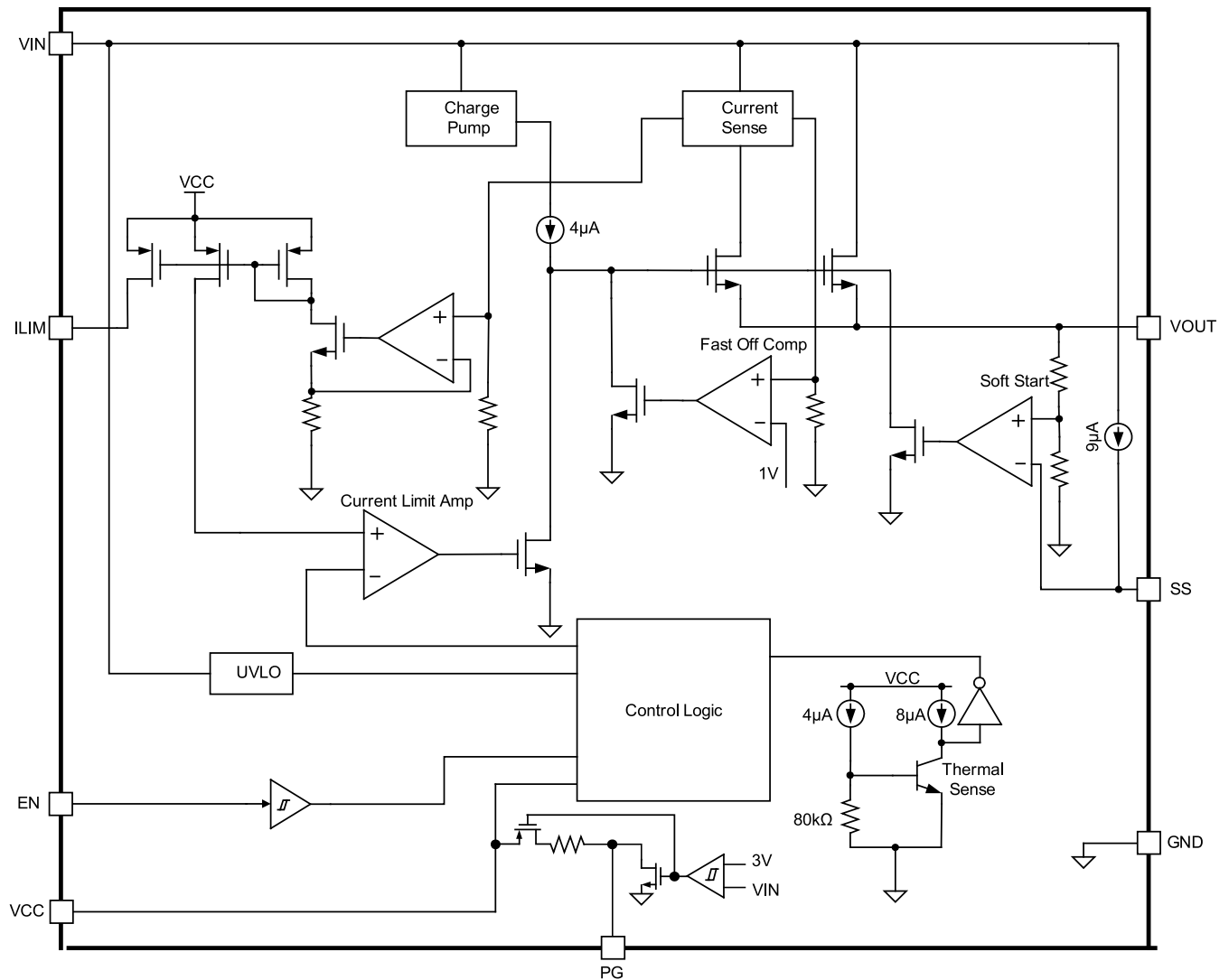

Figure 1: Functional Block Diagram

## OPERATION

The MP5087A is designed to limit the in-rush current to the load, thereby limiting the backplane's voltage drop and the slew rate of the voltage to the load. It provides an integrated solution to monitor the input voltage and output current to eliminate the need for an external current power MOSFET, and current switch device.

### Enable

When input voltage is greater than the under-voltage lockout threshold (UVLO), typically 0.5V, MP5087A can be enabled by pulling EN pin to higher than 1.5V. Pulling down and floating to ground will disable MP5087A.

The recommend start up sequence is power up VIN first. After V<sub>IN</sub> is ready, pull EN voltage to high.

### Current Limit

The MP5087A provides a constant current limit that can be programmed by an external resistor. Once the device reaches its current limit threshold, the internal circuit regulates the gate voltage to hold the current in the power FET constant. The typical response time is about 20μs and the output current may have a small overshoot during this time period.

The pre-set current limit value can be calculated by below equation:

$$I_{LIM}(A) = \frac{82000}{R_{LIM}(\Omega)} \quad (1)$$

R<sub>LIM</sub> is R1 which is placed between ILIM pin to ground in Figure 4.

If the current limit block starts to regulate the output current, the power loss on power MOSFET will cause the IC temperature rise. If the junction temperature rose to high enough, it will trigger thermal shutdown. After thermal shutdown happened, it will disable the output until the over temperature fault remove. The over temperature threshold is 155°C and hysteresis is 30°C.

### Power-Good Function

The PG pin is the push pull output that can be pulled high to V<sub>CC</sub>. The V<sub>IN</sub> sense input is connected internally to monitored system voltage directly. When the V<sub>IN</sub> voltage raises over 3V, PG is high. A threshold hysteresis will prevent the chip from responding perturbation on V<sub>IN</sub> pin.

### Short-Circuit Protection

If the load current increases rapidly due to a short circuit, the current may exceed the current limit threshold by a lot before the control loop can respond. If the current reaches an internal secondary current limit level (about 13A), a fast turn-off circuit activates to turn off the power FET. This limits the peak current through the switch to limit the input voltage drop. The total short circuit response time is about 200ns. If fast off works, it will keep off the power FET for 80μs. After that time period, it will re-turn on power FET.

### Output Discharge

MP5087A has output discharge function. This function can discharge the V<sub>OUT</sub> by internal pull down resistance when IC EN or V<sub>CC</sub> disabled and the load is very light.

### Soft-Start

A capacitor connected to the SS pin determines the soft-start time. There is an internal 9μA constant current source charge SS cap and ramps up the voltage on the SS pin. The output voltage rises at 3 times the slew rate to the SS voltage.

The soft-start time can be calculated by below equation:

$$T_{SS}(ms) = \frac{1}{3} \times \frac{V_{OUT}(V) \cdot C_{SS}(nF)}{I_{SS}(\mu A)} \quad (2)$$

T<sub>SS</sub> is the soft-start time, I<sub>SS</sub> is internal 9μA constant current, C<sub>SS</sub> is external soft-start cap.

The suggestion minimum SS cap should be bigger than 4.7nF. If the SS pin is floated or SS cap is too small, the V<sub>out</sub> rising time will be just limited by power MOS charge time.

## APPLICATION INFORMATION

### ILIM Resistor Selection

The current limit value can be set by ILIM resistor. The current limit can be gotten by equation (1).

The current limit threshold is suggested to 10% ~ 20% higher than maximum load current. For example, if the system's full load is 7A, set the current limit to 7.7A.

### ILIM Capacitor Selection

The internal advanced auto-zero comparator bring a high accuracy of current limit. The auto-zero will also cause some little jitter on ILIM pin. To get a more stable ILIM, a small ceramic capacitor can be mounted between ILIM and ground. Suggested place a ILIM capacitor less than 1nF.

### Soft Start Capacitor Selection

There is an internal 9 $\mu$ A constant current source charge SS cap and ramps up the voltage on the SS pin. The output voltage rises follow 3 times the slew rate of SS voltage.

If the inrush on output current reached the current limit during start up (like with large output cap or very large load), MP5087A will limit the output current and the same time, SS time will be increased (Figure 2 and Figure 3).

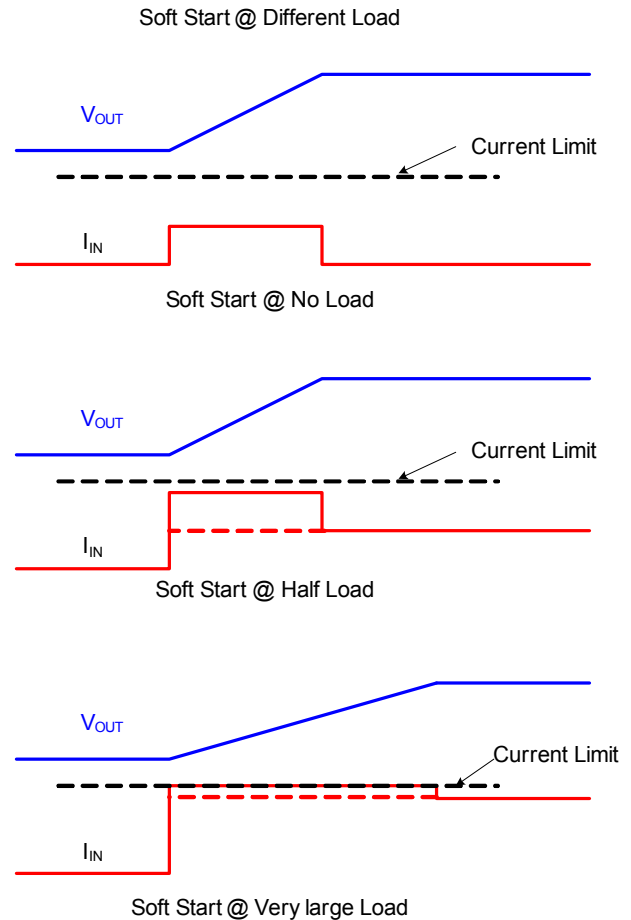

**Figure 2: Soft Start Periods at different load**

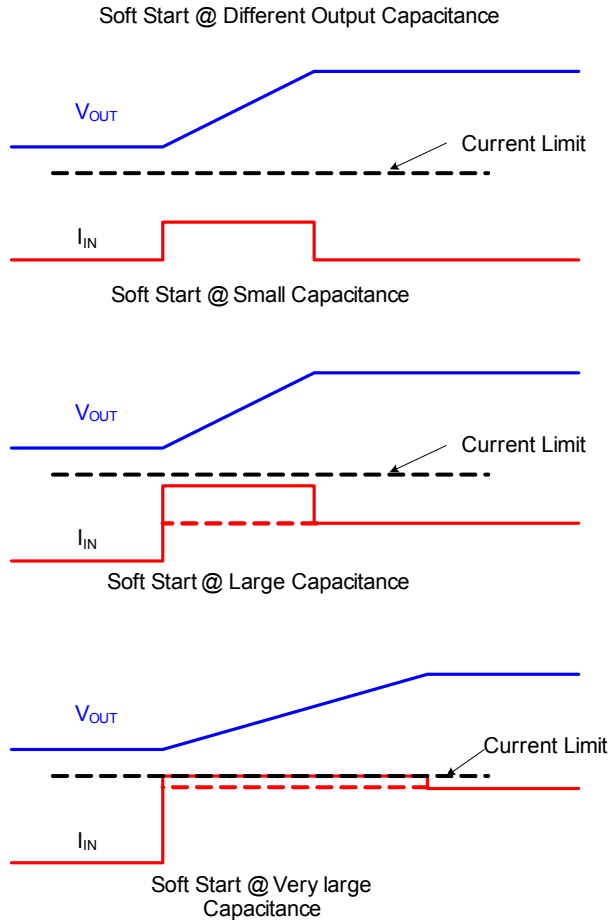

**Figure 3: Soft Start Periods at different output capacitance**

**Design Example**

Some design examples are provided below. See Table 1 and Figure 4.

**Table 1**

$V_{IN}$ (V)	Max Load Range (A)	$R_{LIM}$ (k $\Omega$ )	SS cap (nF)	SS time (ms)
5	3	26.1	22	4
5	5	15.8	47	9
5	7.5	10.5	100	20

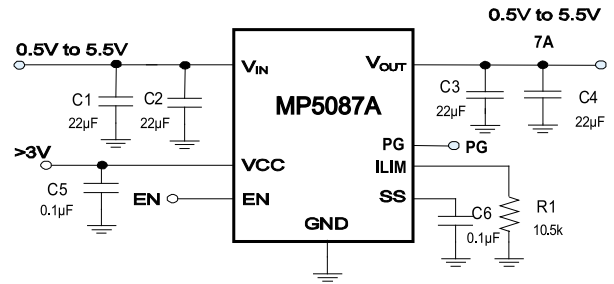

**Figure 4: Typical Application Schematic**

**Layout Guide**

PCB layout is very important to achieve stable operation. Please follow these guidelines and take below figure for reference (take schematic in Figure 4 as an example). Place ILIM resistor (R1 in Figure 4) close to ILIM pin, input cap close to  $V_{CC}$  pin. Put enough vias around IC to achieve better thermal performance.

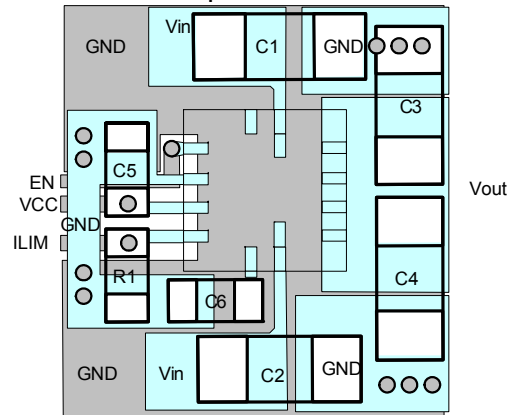

**Figure 5: Recommended Layout**

## PACKAGE INFORMATION

### QFN-12 (2mmx2mm)

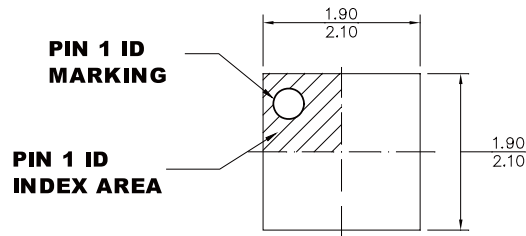

**TOP VIEW**

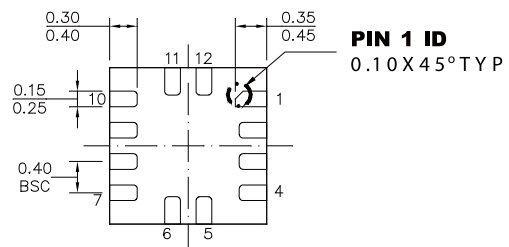

**BOTTOM VIEW**

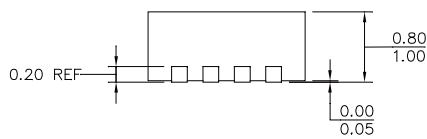

**SIDE VIEW**

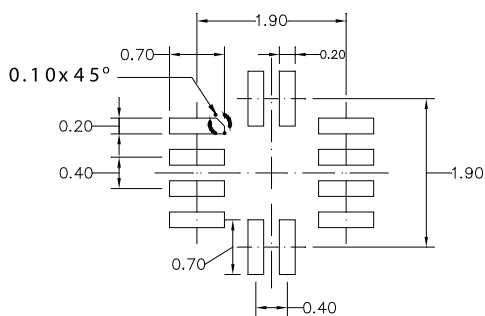

**RECOMMENDED LAND PATTERN**

### NOTE:

- 1) ALL DIMENSIONS ARE IN MILLIMETERS
- 2) EXPOSED PADDLE SIZE DOES NOT INCLUDE MOLD FLASH
- 3) LEAD COPLANARITY SHALL BE 0.10 MILLIMETERS MAX
- 4) JEDEC REFERENCE IS MQ220.
- 5) DRAWING IS NOT TO SCALE

**NOTICE:** The information in this document is subject to change without notice. Please contact MPS for current specifications. Users should warrant and guarantee that third party Intellectual Property rights are not infringed upon when integrating MPS products into any application. MPS will not assume any legal responsibility for any said applications.