

Nylon Strain Relief Fittings



- 3 Nylon Fittings - Introduction
- 4 Straight Dome/Flex - PG/NPT Threads
- 5 Straight Dome/Flex - Metric Threads
- 6 Straight Dome/Flex - Elongated PG/Metric Threads
- 7 Straight Dome/Flex - Reduced/Enlarged Body - PG
- 8 90° Snap Elbow Dome/Flex - PG/NPT/Metric Threads
- 9 Clamp High Performance Pull-Out Resist. - PG & Metric
- 9 Romex® Fittings for Flat Cable
- 10 Multi-Hole Fittings - PG Threads
- 11 Multi-Hole Fittings - NPT Threads
- 12 Multi-Hole Fittings - Metric Threads



Nickel Plated Brass Fittings

- 13 Nickel Plated Brass Fittings - Introduction
- 14 Straight Dome/Flex - PG/NPT & Metric Threads
- 15 Straight Dome/Flex - Elongated PG/Metric Threads
- 16 Mini WADI - Smallest Cable O.D. - PG & Metric
- 16 Wadi XL - Largest Cable O.D. - Metric & BSPP
- 17 90° Snap Elbow Dome - PG/Metric Threads & Flange
- 17 Clamping Extra Pull-out Resistance - PG/NPT/Metric
- 17 Clamp Extra Pull-out Resistance - Elongated PG/Metric
- 18 EMI/RFI Fittings: Product Features
- 19 EMI/RFI Fittings: Applications & Assembly
- 20 EMI/RFI: Standard - PG/NPT/Metric Threads
- 20 EMI/RFI: Standard - Elongated PG/Metric
- 21 EMI/RFI: Feed-Through - PG/NPT/Metric Threads
- 21 EMI/RFI: Feed-Through - Elongated PG/Metric
- 22 Multi-Hole Fittings - PG Threads
- 23 Multi-Hole Fittings - NPT Threads
- 24 Multi-Hole Fittings - Metric Threads



PVDF & Stainless Steel Fittings

- 25 PVDF (FPM) High/Low Temp. - PG/NPT & Metric
- 26 Nickel Plated Brass w/ PVDF (FPM) - PG/NPT/Metric
- 26 Nickel Plated Brass w/ PVDF (FPM) - Elong. PG/Metric
- 27 (303 & 316L) Stainless Steel Fittings - PG/NPT & Metric
- 28 Stainless Steel Hygienic - RG & FP



Strain Relief Accessories

- 29 Locking Nuts - Nylon, Nickel Plated Brass & Accessories Overview
- 30 Locking Nuts - EMI/RFI, Stainless Steel, Zinc Plated Steel, Nickel Plated Brass
- 31 O-Rings & Seal Rings, Blind Plugs - Nylon
- 32 Dome Plugs - Nylon & Nickel Plated Brass
- 32 Hex Plugs - Black Nylon
- 33 Hex Plugs - Nickel Plated Brass
- 33 Hex Plugs - (303) Stainless Steel (INOX)
- 34 Cable Clamp (Low Profile) - Nickel Plated Brass
- 34 Deep Socket Wrenches - PG/NPT/Metric Sizes

Adapters, Reducers, Enlargers

- 35 Thread Adapters - Nickel Plated Brass
- 35 Thread Adapters - Aluminum
- 36 Thread Adapters - Black Nylon & Polypropylene
- 37 Thread Reducers - Nickel Plated Brass (Hex & Round)
- 38 Thread Reducers - Black/Gray Nylon & Polypropylene
- 39 Thread Reducers - (303) Stainless Steel
- 40 Thread Enlargers - Black Nylon, NPB & Polypropylene



Conduit System

- 41 Conduit System - Introduction
- 42 Nylon Series - Solid & Slit Conduit
- 42 Nylon Series - Mounting Bracket
- 43 Nylon Series - Straight Push-In Fitting
- 43 Nylon Series - Elbow Push-In Fitting
- 44 Nylon Series - Push-In Rotatable Fitting
- 44 Nylon Series - 90° Fitting
- 44 Nylon Series - Y Fitting
- 45 Nylon Series - T Fitting
- 45 Nylon Series - DUO-PA Fitting
- 46 Nylon Series - Nickel Plated Brass DUO-MS Fitting
- 47 Nylon Series - Bulkhead Fittings
- 48 Superflex Series - Superflex Conduit
- 48 Superflex Series - Turn to Seal Straight & Elbow Fittings
- 49 Metal Series - Metal Conduit, Metal Fit & Metal Fit S
- 50 Metal Pro Series - Metal Pro Conduit (A,B,C)
- 51 Metal Pro Series - Metal Fit Pro & Metal Fit Pro S Fittings
- 51 Metal Pro Series - Metal Fit Clip



Technical Information

- 52 Material Specifications, Temp. & Color
- 53 Type NEMA Ratings - Description & Class
- 54 IP Ratings - Descriptions
- 55 Specifications - Torque & Thread Diameter
- 56 Thread Specifications & Pitch - NPT, Metric & PG



Other Products / Index

- 57 Circular Connectors (M8-M40)
- 58 Varia Pro
- 59 Stainless Steel - Ex/EXIOS - (INOX) 303 & 316L
- 60 Industrial Enclosure Solutions
- 61 P/N Index / Cross Reference
- 62 P/N Index / Cross Reference
- 63 P/N Index / Cross Reference - M12 Cordsets



Why choose Sealcon as your cable management partner?

Sealcon was founded in the fall of 1989 in Englewood, Colorado. Our goal is to provide customers with the best possible cable management solutions. We are proud to represent the leading German manufacturer of Liquid Tight Strain Relief Fittings, Cord Grips, Cable Glands, Circular Connectors, Industrial Enclosures, Flexible Conduit, and Other Cable & Wire Accessory Products. These products meet RoHS, Deca BDE, Reach, UL, UR, CSA, VDE, CE, TÜV, German Lloyd, PCT, SZU, Gost, Ex-e, Ex-d, IECEx, ATEX approvals. Our manufacturer is ISO 9001 quality certified and has continuously developed leading edge technology solutions.

We can usually ship your order within 24 hours from our central warehouse in Colorado. We replenish our inventory weekly and can respond to changing demands quickly. This catalog is a condensed version of our supplier's master catalog and is available to our customers upon request. Our experienced staff will help to answer any technical questions and are able to recommend the correct samples for evaluation. Purchase orders, received before noon MST are often shipped the same day. Please give us a call so we can help you with your application requirements. Sample your application or request your catalog today!

Daniel Spühler, CEO & President

Features & Benefits:

- Type NEMA 4x & 6 (IP 67 & 68) - Liquid Tight - Submersible to 300 ft!
- IP 69K rated - Ideal in splash or hose down applications!
- Patented Form Seal allows 150 PSIG (10 BAR) rating - Highest in Industry!
- V0 flame rating according to UL 94 (Dome Nylon & PVDF Only) - Phosphorous Free - Non-Toxic!
- UL f1 (746C) UV/Ozone stable Black Nylon - Ideal for the Outdoors!
- Concentric O-Ring Groove - meets most Type NEMA applications!
- Safety Ratchet Top Cap - Preventing Dome/Flex top from coming loose under vibration!
- Large selection - Cable Range from .08" (2 mm) to 1.73" (44 mm).
- Non-Corrosive - Resistant to salt water, weak acids, weak alkalis, alcohol, esters, ketones, ether, gasoline, mineral, animal & vegetable oil.
- Durable - Rugged Construction.
- RoHS & Deca BDE - Environmentally Compliant to the newest standards!

UL/UR	E103997
CSA	074032
VDE	71339
CAGE	0 UE11
PATENT	4145075



High Impact / DIV Rated
BXA & BXI Strain Relief

Unique Product!



Pull-out Resistance & Cable Protection

Overlapping clamping splines apply a concentric pressure to seal around cable, thereby preventing the form seal from being pulled out of the fitting. This ensures pull-out protection without damage to the cable.

Submersible

The patented recess and high performance form seal (grommet) guarantees Type NEMA 4x & 6 (IP 68 / IP 69K) at 150 PSIG (10 bar).

Rugged Construction

The self locking ACME thread prevents the dome or flex nut from being pulled out under extreme lateral force.

Liquid Tight

Molded O-Ring groove with O-Ring results in a liquid tight seal between Fitting and Installation.

Time Saving Installation

Simply push the cable through Strain Relief Fitting - Tighten Dome or Flex Nut - Done!
No disassembly of the Fitting required!



ULf1 (746C) Outdoor Applications

All Black Nylon (Dome & Flex) Strain Relief Fittings, Cord Grips, Cable Glands are now made with UV / Ozone Stable material.



Standard, Reduced and Multi-Hole Inserts

Modularity: Increase and decrease cable opening by swapping out inserts to accommodate various cable sizes & configurations.

Also available in ATEX/IECEX & cUS



Flex Nut

Kinking and chafing of the cable is eliminated in dynamic applications.



Elbow Fittings

For Space and time saving installations:
Open Elbow - Insert cable - Snap close - Tighten Nut - Finished!
Available with Dome for static, or Flex Nut for dynamic applications.



How to feed a cable assembly with connector through a strain relief fitting:

1. Determine largest dimension of the plug.
2. Choose Strain Relief with appropriate Dome opening (see table on page 56).
3. Drill solid insert to exact cable diameter & slice insert on one side only.
4. Assemble by feeding Connector first through dome nut and Strain Relief body, snap insert over cable and insert into body, tighten dome nut - Done!
5. This applies to PG, NPT or Metric solutions.

NOTE: Nylon Fittings do not come with an O-Ring.

Romex® is a federally registered trademark of Southwire Company.

Nylon Liquid Tight Strain Relief Fittings

Standard - PG & NPT Threads



Nylon Strain Relief

Part Numbers				Cable Range	Thread Type & Size	Dimensions in Inches (mm)				
-40°F to 212°F (-40°C to 100°C)						A	B	C	TL	F ₁ /F
Dome Fittings		Flex Fittings		Inches (mm)	See Page 56 for thread specs	Clearance Hole	Body Length (Dome)	Body Length (Flex)	Thread Length	Wrench Flats
Black	Gray	Black	Gray			+ .01" (+.25 mm)				
CD07AA-BK	CD07AA-GY	CF07AA-BK	CF07AA-GY	.12 - .26 (3 - 6.5)	PG 7 / 1/4" NPT	.49 (12.5)	.83 (21)	2.13 (54)	.31 (8)	.59 (15)
CD07AR-BK	CD07AR-GY	CF07AR-BK	CF07AR-GY	.08 - .20 (2 - 5)						
CD09AA-BK	CD09AA-GY	CF09AA-BK	CF09AA-GY	.16 - .31 (4 - 8)	PG 9	.60 (15.2)	.87 (22)	2.48 (63)	.31 (8)	.75 (19)
CD09AR-BK	CD09AR-GY	CF09AR-BK	CF09AR-GY	.08 - .24 (2 - 6)						
CD11AA-BK	CD11AA-GY	CF11AA-BK	CF11AA-GY	.20 - .39 (5 - 10)	PG11	.73 (18.5)	.98 (25)	3.07 (78)	.31 (8)	.87 (22)
CD11AR-BK	CD11AR-GY	CF11AR-BK	CF11AR-GY	.12 - .28 (3 - 7)						
CD13AA-BK	CD13AA-GY	CF13AA-BK	CF13AA-GY	.24 - .47 (6 - 12)	PG 13 / 13.5	.80 (20.3)	1.06 (27)	3.54 (90)	.35 (9)	.94 (24)
CD13AR-BK	CD13AR-GY	CF13AR-BK	CF13AR-GY	.20 - .35 (5 - 9)						
CD16AA-BK	CD16AA-GY	CF16AA-BK	CF16AA-GY	.39 - .55 (10 - 14)	PG 16	.89 (22.5)	1.10 (28)	3.94 (100)	.39 (10)	1.06 (27)
CD16AR-BK	CD16AR-GY	CF16AR-BK	CF16AR-GY	.28 - .47 (7-12)						
CD21AA-BK	CD21AA-GY	CF21AA-BK	CF21AA-GY	.51 - .71 (13 - 18)	PG 21	1.12 (28.4)	1.22 (31)	4.49 (114)	.43 (11)	1.30 (33)
CD21AR-BK	CD21AR-GY	CF21AR-BK	CF21AR-GY	.35 - .63 (9 - 16)						
CD29AA-BK	CD29AA-GY	-	-	.71 - .98 (18 - 25)	PG 29	1.47 (37.3)	1.54 (39)	-	.43 (11)	1.65 (42)
CD29AR-BK	CD29AR-GY	-	-	.51 - .79 (13 - 20)						
CD36AA-BK	CD36AA-GY	-	-	.87 - 1.26 (22 - 32)	PG 36	1.85 (47)	1.89 (48)	-	.51 (13)	2.09 (53)
CD36AR-BK	CD36AR-GY	-	-	.79 - 1.02 (20 - 26)						
CD42AA-BK	CD42AA-GY	-	-	1.26 - 1.50 (32 - 38)	PG 42	2.13 (54.1)	1.93 (49)	-	.51 (13)	2.36 (60)
CD42AR-BK	CD42AR-GY	-	-	.98 - 1.22 (25 - 31)						
CD48AA-BK	CD48AA-GY	-	-	1.46 - 1.73 (37 - 44)	PG 48	2.34 (59.4)	1.93 (49)	-	.55 (14)	2.56 (65)
CD48AR-BK	CD48AR-GY	-	-	1.14 - 1.38 (29 - 35)						
CD09NA-BK	CD09NA-GY	CF09NA-BK	CF09NA-GY	.16 - .31 (4 - 8)	3/8" NPT	.68 (17.2)	.87 (22)	2.48 (63)	.59 (15)	.75 (19) / .87 (22)
CD09NR-BK	CD09NR-GY	CF09NR-BK	CF09NR-GY	.08 - .24 (2 - 6)						
CD13NA-BK	CD13NA-GY	CF13NA-BK	CF13NA-GY	.24 - .47 (6 - 12)	1/2" NPT	.83 (21.1)	1.06 (27)	3.54 (90)	.51 (13)	.94 (24)
CD13NR-BK	CD13NR-GY	CF13NR-BK	CF13NR-GY	.20 - .35 (5 - 9)						
CD16NA-BK	CD16NA-GY	CF16NA-BK	CF16NA-GY	.39 - .55 (10 - 14)	1/2" - E NPT	.83 (21.1)	1.10 (28)	3.94 (100)	.51 (13)	1.06 (27)
CD16NR-BK	CD16NR-GY	CF16NR-BK	CF16NR-GY	.28 - .47 (7 - 12)						
CD21NA-BK	CD21NA-GY	CF21NA-BK	CF21NA-GY	.51 - .71 (13 - 18)	3/4" NPT	1.05 (26.7)	1.22 (31)	4.49 (114)	.55 (14)	1.30 (33)
CD21NR-BK	CD21NR-GY	CF21NR-BK	CF21NR-GY	.35 - .63 (9 - 16)						
CD29NA-BK	CD29NA-GY	-	-	.71 - .98 (18 - 25)	1" NPT	1.35 (34.3)	1.54 (39)	-	.75 (19)	1.65 (42)
CD29NR-BK	CD29NR-GY	-	-	.51 - .79 (13 - 20)						
CD29LA-BK	CD29LA-GY	-	-	.71 - .98 (18 - 25)	1-1/4" NPT	1.65 (41.9)	1.54 (39)	-	.63 (16)	1.65 (42) / 1.81 (46)
CD29LR-BK	CD29LR-GY	-	-	.51 - .79 (13 - 20)						
CD36NA-BK	CD36NA-GY	-	-	.87 - 1.26 (22 - 32)	1-1/2" NPT	1.92 (48.7)	1.89 (48)	-	.79 (20)	2.09 (53)
CD36NR-BK	CD36NR-GY	-	-	.79 - 1.02 (20 - 26)						

The straight PG 7 thread fits a 1/4" NPT female or 1/2"-20 UNF thread.
 *UL f1 (746C) rating applies to Black Nylon Fittings only.

Dome Fittings also available with the following approvals:



www.SealconEX.com



Optional Locking Nuts, O-Rings & Other Accessories starting on Page 29 - 40.

For Material Specifications and Approval Information refer to page 52.



Part Numbers				Cable Range	Thread Type & Size	Dimensions in Inches (mm)				
-40°F to 212°F (-40°C to 100°C)						A	B	C	TL	F ₁ /F
Dome Fittings		Flex Fittings		Inches (mm)	See Page 56 for thread specs	Clearance Hole	Body Length (Dome)	Body Length (Flex)	Thread Length	Wrench Flats
Black	Gray	Black	Gray			+ .01" (+.25 mm)				
CD12MA-BK	CD12MA-GY	CF12MA-BK	CF12MA-GY	.12 - .26 (3 - 6.5)	M12 X 1.5	.47 (12)	.83 (21)	2.13 (54)	.31 (8)	.59 (15)
CD12MR-BK	CD12MR-GY	CF12MR-BK	CF12MR-GY	.08 - .20 (2 - 5)						
CD16MA-BK	CD16MA-GY	CF16MA-BK	CF16MA-GY	.16 - .31 (4 - 8)	M16 X 1.5	.63 (16)	.87 (22)	2.48 (63)	.31 (8)	.75 (19)
CD16MR-BK	CD16MR-GY	CF16MR-BK	CF16MR-GY	.08 - .24 (2 - 6)						
CD17MA-BK	CD17MA-GY	CF17MA-BK	CF17MA-GY	.20 - .39 (5 - 10)	M16 X 1.5 Enlarged	.63 (16)	.98 (25)	3.07 (78)	.31 (8)	.87 (22)
CD17MR-BK	CD17MR-GY	CF17MR-BK	CF17MR-GY	.12 - .28 (3 - 7)						
CD20MA-BK	CD20MA-GY	CF20MA-BK	CF20MA-GY	.24 - .47 (6 - 12)	M20 X 1.5	.79 (20)	1.06 (27)	3.54 (90)	.35 (9)	.94 (24)
CD20MR-BK	CD20MR-GY	CF20MR-BK	CF20MR-GY	.20 - .35 (5 - 9)						
CD22MA-BK	CD22MA-GY	CF22MA-BK	CF22MA-GY	.39 - .55 (10 - 14)	M20 X 1.5 Enlarged	.79 (20)	1.10 (28)	3.94 (100)	.39 (10)	1.06 (27)
CD22MR-BK	CD22MR-GY	CF22MR-BK	CF22MR-GY	.28 - .47 (7-12)						
CD25MA-BK	CD25MA-GY	CF25MA-BK	CF25MA-GY	.51 - .71 (13 - 18)	M25 X 1.5	.98 (25)	1.22 (31)	4.49 (114)	.43 (11)	1.30 (33)
CD25MR-BK	CD25MR-GY	CF25MR-BK	CF25MR-GY	.35 - .63 (9 - 16)						
CD32MA-BK	CD32MA-GY	-	-	.71 - .98 (18 - 25)	M32 X 1.5	1.26 (32)	1.54 (39)	-	.43 (11)	1.65 (42)
CD32MR-BK	CD32MR-GY	-	-	.51 - .79 (13 - 20)						
CD40MA-BK	CD40MA-GY	-	-	.87 - 1.26 (22 - 32)	M40 X 1.5	1.57 (40)	1.89 (48)	-	.51 (13)	2.09 (53)
CD40MR-BK	CD40MR-GY	-	-	.79 - 1.02 (20 - 26)						
CD50MA-BK	CD50MA-GY	-	-	1.26 - 1.50 (32 - 38)	M50 X 1.5	1.97 (50)	1.93 (49)	-	.51 (13)	2.36 (60)
CD50MR-BK	CD50MR-GY	-	-	.98 - 1.22 (25 - 31)						
CD63MA-BK	CD63MA-GY	-	-	1.46 - 1.73 (37 - 44)	M63 X 1.5	2.48 (63)	1.93 (49)	-	.55 (14)	2.56 (65) / 2.68 (68)
CD63MR-BK	CD63MR-GY	-	-	1.14 - 1.38 (29 - 35)						

*UL f1 (746C) rating applies to Black Nylon Fittings only.



Installs in either knockout or threaded holes.

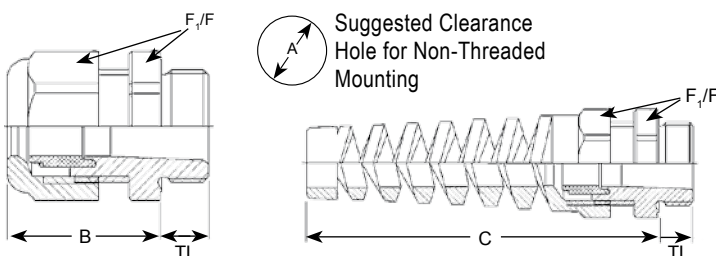

Dome Fittings also available with the following approvals:



www.SealconEX.com



Optional Locking Nuts, O-Rings & Other Accessories starting on Page 29 - 40.

Nylon Liquid Tight Strain Relief Fittings

Elongated - PG & Metric Threads



Elongated Thread Fittings

are recommended where the Strain Relief has to pass through a thick wall or the application just needs the extra thread length.

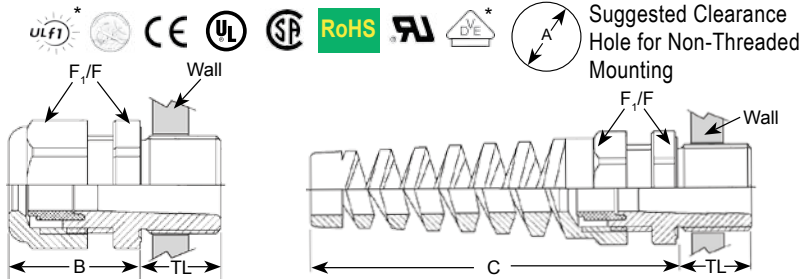

Optional Locking Nuts, O-Rings & Other Accessories starting on Page 29 - 40.

Dome Fittings also available with the following approvals:



www.SealconEX.com

Nylon Strain Relief

Part Numbers				Cable Range	Thread Type & Size	Dimensions in Inches (mm)				
-40°F to 212°F (-40°C to 100°C)						A	B	C	TL	F ₁ /F ₂
Dome Fittings		Flex Fittings		Inches (mm)	See Page 56 for thread specs	Clearance Hole	Body Length (Dome)	Body Length (Flex)	Thread Length	Wrench Flats
Black	Gray	Black	Gray			+ .01" (+.25 mm)	Elongated			
CD07CA-BK	CD07CA-GY	CF07CA-BK	CF07CA-GY	.12 - .26 (3 - 6.5)	PG 7	.49 (12.5)	.83 (21)	2.13 (54)	.59 (15)	.59 (15)
CDO7CR-BK	CDO7CR-GY	CF07CR-BK	CF07CR-GY	.08 - .20 (2 - 5)						
CD09CA-BK	CD09CA-GY	CF09CA-BK	CF09CA-GY	.16 - .31 (4 - 8)	PG 9	.60 (15.2)	.87 (22)	2.48 (63)	.59 (15)	.75 (19)
CD09CR-BK	CD09CR-GY	CF09CR-BK	CF09CR-GY	.08 - .24 (2 - 6)						
CD11CA-BK	CD11CA-GY	CF11CA-BK	CF11CA-GY	.20 - .39 (5 - 10)	PG 11	.73 (18.5)	.98 (25)	3.07 (78)	.59 (15)	.87 (22)
CD11CR-BK	CD11CR-GY	CF11CR-BK	CF11CR-GY	.12 - .28 (3 - 7)						
CD13CA-BK	CD13CA-GY	CF13CA-BK	CF13CA-GY	.24 - .47 (6 - 12)	PG 13 / 13.5	.80 (20.3)	1.06 (27)	3.54 (90)	.59 (15)	.94 (24)
CD13CR-BK	CD13CR-GY	CF13CR-BK	CF13CR-GY	.20 - .35 (5 - 9)						
CD16CA-BK	CD16CA-GY	CF16CA-BK	CF16CA-GY	.39 - .55 (10 - 14)	PG 16	.89 (22.5)	1.10 (28)	3.94 (100)	.59 (15)	1.06 (27)
CD16CR-BK	CD16CR-GY	CF16CR-BK	CF16CR-GY	.28 - .47 (7-12)						
CD21CA-BK	CD21CA-GY	CF21CA-BK	CF21CA-GY	.51 - .71 (13 - 18)	PG 21	1.12 (28.4)	1.22 (31)	4.49 (114)	.59 (15)	1.30 (33)
CD21CR-BK	CD21CR-GY	CF21CR-BK	CF21CR-GY	.35 - .63 (9 - 16)						
CD29CA-BK	CD29CA-GY	-	-	.71 - .98 (18 - 25)	PG 29	1.47 (37.3)	1.54 (39)	-	.59 (15)	1.65 (42)
CD29CR-BK	CD29CR-GY	-	-	.51 - .79 (13 - 20)						
CD36CA-BK	CD36CA-GY	-	-	.87 - 1.26 (22 - 32)	PG 36	1.85 (47)	1.89 (48)	-	.71 (18)	2.09 (53)
CD36CR-BK	CD36CR-GY	-	-	.79 - 1.02 (20 - 26)						
CD42CA-BK	CD42CA-GY	-	-	1.26 - 1.50 (32 - 38)	PG 42	2.13 (54.1)	1.93 (49)	-	.71 (18)	2.36 (60)
CD42CR-BK	CD42CR-GY	-	-	.98 - 1.22 (25 - 31)						
CD48CA-BK	CD48CA-GY	-	-	1.46 - 1.73 (37 - 44)	PG 48	2.34 (59.4)	1.93 (49)	-	.71 (18)	2.56 (65)
CD48CR-BK	CD48CR-GY	-	-	1.14 - 1.38 (29 - 35)						
CD12DA-BK	CD12DA-GY	CF12DA-BK	CF12DA-GY	.12 - .26 (3 - 6.5)	M12 X 1.5	.47 (12)	.83 (21)	2.13 (54)	.59 (15)	.59 (15)
CD12DR-BK	CD12DR-GY	CF12DR-BK	CF12DR-GY	.08 - .20 (2 - 5)						
CD16DA-BK	CD16DA-GY	CF16DA-BK	CF16DA-GY	.16 - .31 (4 - 8)	M16 X 1.5	.63 (16)	.87 (22)	2.48 (63)	.59 (15)	.75 (19)
CD16DR-BK	CD16DR-GY	CF16DR-BK	CF16DR-GY	.08 - .24 (2 - 6)						
CD17DA-BK	CD17DA-GY	CF17DA-BK	CF17DA-GY	.20 - .39 (5 - 10)	M16 X 1.5 Enlarged	.63 (16)	.98 (25)	3.07 (78)	.59 (15)	.87 (22)
CD17DR-BK	CD17DR-GY	CF17DR-BK	CF17DR-GY	.12 - .28 (3 - 7)						
CD20DA-BK	CD20DA-GY	CF20DA-BK	CF20DA-GY	.24 - .47 (6 - 12)	M20 X 1.5	.79 (20)	1.06 (27)	3.54 (90)	.59 (15)	.94 (24)
CD20DR-BK	CD20DR-GY	CF20DR-BK	CF20DR-GY	.20 - .35 (5 - 9)						
CD22DA-BK	CD22DA-GY	CF22DA-BK	CF22DA-GY	.39 - .55 (10 - 14)	M20 X 1.5 Enlarged	.79 (20)	1.10 (28)	3.94 (100)	.59 (15)	1.06 (27)
CD22DR-BK	CD22DR-GY	CF22DR-BK	CF22DR-GY	.28 - .47 (7-12)						
CD25DA-BK	CD25DA-GY	CF25DA-BK	CF25DA-GY	.51 - .71 (13 - 18)	M25 X 1.5	.98 (25)	1.22 (31)	4.49 (114)	.59 (15)	1.30 (33)
CD25DR-BK	CD25DR-GY	CF25DR-BK	CF25DR-GY	.35 - .63 (9 - 16)						
CD32DA-BK	CD32DA-GY	-	-	.71 - .98 (18 - 25)	M32 X 1.5	1.26 (32)	1.54 (39)	-	.59 (15)	1.65 (42)
CD32DR-BK	CD32DR-GY	-	-	.51 - .79 (13 - 20)						
CD40DA-BK	CD40DA-GY	-	-	.87 - 1.26 (22 - 32)	M40 X 1.5	1.57 (40)	1.89 (48)	-	.71 (18)	2.09 (53)
CD40DR-BK	CD40DR-GY	-	-	.79 - 1.02 (20 - 26)						
CD50DA-BK	CD50DA-GY	-	-	1.26 - 1.50 (32 - 38)	M50 X 1.5	1.97 (50)	1.93 (49)	-	.71 (18)	2.36 (60)
CD50DR-BK	CD50DR-GY	-	-	.98 - 1.22 (25 - 31)						
CD63DA-BK	CD63DA-GY	-	-	1.46 - 1.73 (37 - 44)	M63 X 1.5	2.48 (63)	1.93 (49)	-	.71 (18)	2.56 (65) / 2.68 (68)
CD63DR-BK	CD63DR-GY	-	-	1.14 - 1.38 (29 - 35)						

*UL f1 (746C) rating applies to Black Nylon Fittings only.

*VDE rating applies to Metric Fittings only.

Reduced Body -

When your cable diameter decreases, but your thread remains the same.

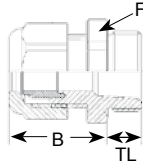

Suggested Clearance Hole for Non-Threaded Mounting

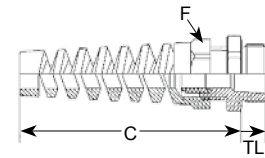

Reduced Body Strain Relief Fittings										
Part Numbers				Cable Range	Thread Type & Size	Dimensions in Inches (mm)				
-40°F to 212°F (-40°C to 100°C)						A	B	C	TL	F
Dome Fittings		Flex Fittings		Inches (mm)	See Page 56 for thread specs	Clearance Hole	Body Length (Dome)	Body Length (Flex)	Thread Length	Wrench Flats
								+.01" (+.25 mm)		
CD09BA-BK	CD09BA-GY	CF09BA-BK	CF09BA-GY	.11 - .26 (3 - 6.5)	PG 9	.60 (15.2)	.83 (21)	2.13 (54)	.31 (8)	.75 (19)
CD09BR-BK	CD09BR-GY	CF09BR-BK	CF09BR-GY	.08 - .20 (2 - 5)						
CD11BA-BK	CD11BA-GY	CF11BA-BK	CF11BA-GY	.16 - .31 (4 - 8)	PG11	.73 (18.5)	.87 (22)	2.48 (63)	.31 (8)	.87 (22)
CD11BR-BK	CD11BR-GY	CF11BR-BK	CF11BR-GY	.08 - .24 (2 - 6)						
CD13BA-BK	CD13BA-GY	CF13BA-BK	CF13BA-GY	.20 - .39 (5 - 10)	PG 13 / 13.5	.80 (20.3)	.98 (25)	3.07 (78)	.35 (9)	.94 (24)
CD13BR-BK	CD13BR-GY	CF13BR-BK	CF13BR-GY	.11 - .28 (3 - 7)						
CD16BA-BK	CD16BA-GY	CF16BA-BK	CF16BA-GY	.24 - .47 (6 - 12)	PG 16	.89 (22.5)	1.06 (27)	3.54 (90)	.39 (10)	1.06 (27)
CD16BR-BK	CD16BR-GY	CF16BR-BK	CF16BR-GY	.20 - .35 (5 - 9)						
CD21BA-BK	CD21BA-GY	CF21BA-BK	CF21BA-GY	.39 - .55 (10 - 14)	PG 21	1.12 (28.4)	1.10 (28)	3.94 (100)	.43 (11)	1.30 (33)
CD21BR-BK	CD21BR-GY	CF21BR-BK	CF21BR-GY	.27 - .47 (7-12)						

Nylon Liquid Tight Strain Relief Fittings Enlarged Body - PG Threads

Enlarged Body -

When your cable diameter increases, but your thread remains the same.



Dome Fittings also available with the following approvals:



www.SealconEX.com



Optional Locking Nuts, O-Rings & Other Accessories starting on Page 29 - 40.

Enlarged Body Strain Relief Fittings										
Part Numbers				Cable Range	Thread Type & Size	Dimensions in Inches (mm)				
-40°F to 212°F (-40°C to 100°C)						A	B	C	TL	F
Dome Fittings		Flex Fittings		Inches (mm)	See Page 56 for thread specs	Clearance Hole	Body Length (Dome)	Body Length (Flex)	Thread Length	Wrench Flats
								+.01" (+.25 mm)		
CD07GA-BK	CD07GA-GY	CF07GA-BK	CF07GA-GY	.16 - .31 (4 - 8)	PG 7 / 1/4" NPT	.49 (12.5)	.87 (22)	2.48 (63)	.31 (8)	.75 (19)
CD07GR-BK	CD07GR-GY	CF07GR-BK	CF07GR-GY	.08 - .24 (2 - 6)						
CD09GA-BK	CD09GA-GY	CF09GA-BK	CF09GA-GY	.20 - .39 (5 - 10)	PG 9	.60 (15.2)	.98 (25)	3.07 (78)	.31 (8)	.87 (22)
CD09GR-BK	CD09GR-GY	CF09GR-BK	CF09GR-GY	.11 - .27 (3 - 7)						
CD11GA-BK	CD11GA-GY	CF11GA-BK	CF11GA-GY	.24 - .47 (6 - 12)	PG 11	.73 (18.5)	.94 (24)	3.54 (90)	.31 (8)	.94 (24)
CD11GR-BK	CD11GR-GY	CF11GR-BK	CF11GR-GY	.20 - .35 (5 - 9)						
CD13GA-BK	CD13GA-GY	CF13GA-BK	CF13GA-GY	.39 - .55 (10 - 14)	PG 13 / 13.5	.80 (20.3)	1.10 (28)	3.94 (100)	.35 (9)	1.06 (27)
CD13GR-BK	CD13GR-GY	CF13GR-BK	CF13GR-GY	.27 - .47 (7-12)						
CD16GA-BK	CD16GA-GY	CF16GA-BK	CF16GA-GY	.51 - .71 (13 - 18)	PG 16	.89 (22.5)	1.22 (31)	4.49 (114)	.39 (10)	1.30 (33)
CD16GR-BK	CD16GR-GY	CF16GR-BK	CF16GR-GY	.35 - .63 (9 - 16)						

*UL f1 (746C) rating applies to Black Nylon Fittings only.

For Material Specifications and Approval Information refer to page 52.

Nylon Liquid Tight Strain Relief Fittings

90° Snap Elbow - PG / NPT / Metric Threads



Nylon Strain Relief

Part Numbers				Cable Range	Thread Type & Size	Dimensions in Inches (mm)					
-40°F to 212°F (-40°C to 100°C)						A	B	C	H	TL	F
Dome Fittings		Flex Fittings		Inches (mm)	See Page 56 for thread specs	Clearance Hole	Body Length (Dome)	Body Length (Flex)	Height	Thread Length	Wrench Flats
								+.01" (+.25 mm)			
ED09AA-BK	ED09AA-GY	EF09AA-BK	EF09AA-GY	.16 - .31 (4 - 8)	PG 9	.60 (15.2)	1.77 (45)	3.35 (85)	.91 (23)	.31 (8)	.75 (19)
ED09AR-BK	ED09AR-GY	EF09AR-BK	EF09AR-GY	.08 - .24 (2 - 6)							
ED11AA-BK	ED11AA-GY	EF11AA-BK	EF11AA-GY	.20 - .39 (5 - 10)	PG11	.73 (18.5)	1.97 (50)	4.05 (103)	1.06 (27)	.31 (8)	.87 (22)
ED11AR-BK	ED11AR-GY	EF11AR-BK	EF11AR-GY	.11 - .28 (3 - 7)							
ED13AA-BK	ED13AA-GY	EF13AA-BK	EF13AA-GY	.24 - .47 (6 - 12)	PG 13 / 13.5	.80 (20.3)	2.24 (57)	4.69 (119)	1.20 (30.5)	.35 (9)	.94 (24)
ED13AR-BK	ED13AR-GY	EF13AR-BK	EF13AR-GY	.20 - .35 (5 - 9)							
ED16AA-BK	ED16AA-GY	EF16AA-BK	EF16AA-GY	.39 - .55 (10 - 14)	PG 16	.89 (22.5)	2.32 (59)	5.12 (130)	1.28 (32.5)	.39 (10)	1.06 (27)
ED16AR-BK	ED16AR-GY	EF16AR-BK	EF16AR-GY	.28 - .47 (7-12)							
ED21AA-BK	ED21AA-GY	EF21AA-BK	EF21AA-GY	.51 - .71 (13 - 18)	PG 21	1.12 (28.4)	2.87 (73)	6.14 (156)	1.57 (40)	.43 (11)	1.30 (33)
ED21AR-BK	ED21AR-GY	EF21AR-BK	EF21AR-GY	.35 - .63 (9 - 16)							
ED29AA-BK	ED29AA-GY	-	-	.71 - .98 (18 - 25)	PG 29	1.47 (37.3)	3.58 (91)	-	2.03 (51.5)	.43 (11)	1.65 (42)
ED29AR-BK	ED29AR-GY	-	-	.51 - .79 (13 - 20)							
ED09NA-BK	ED09NA-GY	EF09NA-BK	EF09NA-GY	.16 - .31 (4 - 8)	3/8" NPT	.68 (17.2)	1.77 (45)	3.35 (85)	.91 (23)	.59 (15)	.75 (19)
ED09NR-BK	ED09NR-GY	EF09NR-BK	EF09NR-GY	.08 - .24 (2 - 6)							
ED13NA-BK	ED13NA-GY	EF13NA-BK	EF13NA-GY	.24 - .47 (6 - 12)	1/2" NPT	.83 (21.1)	2.24 (57)	4.69 (119)	1.20 (30.5)	.51 (13)	.94 (24)
ED13NR-BK	ED13NR-GY	EF13NR-BK	EF13NR-GY	.20 - .35 (5 - 9)							
ED16NA-BK	ED16NA-GY	EF16NA-BK	EF16NA-GY	.39 - .55 (10 - 14)	1/2" -E NPT	.83 (21.1)	2.32 (59)	5.12 (130)	1.28 (32.5)	.51 (13)	1.06 (27)
ED16NR-BK	ED16NR-GY	EF16NR-BK	EF16NR-GY	.28 - .47 (7-12)							
ED21NA-BK	ED21NA-GY	EF21NA-BK	EF21NA-GY	.51 - .71 (13 - 18)	3/4" NPT	1.05 (26.7)	2.87 (73)	6.14 (156)	1.57 (40)	.51 (13)	1.30 (33)
ED21NR-BK	ED21NR-GY	EF21NR-BK	EF21NR-GY	.35 - .63 (9 - 16)							
ED29NA-BK	ED29NA-GY	-	-	.71 - .98 (18 - 25)	1" NPT	1.35 (34.3)	3.58 (91)	-	2.03 (51.5)	.75 (19)	1.65 (42)
ED29NR-BK	ED29NR-GY	-	-	.51 - .79 (13 - 20)							
ED16MA-BK	ED16MA-GY	EF16MA-BK	EF16MA-GY	.16 - .31 (4 - 8)	M16 X 1.5	.63 (16)	1.77 (45)	3.35 (85)	.91 (23)	.31 (8)	.75 (19)
ED16MR-BK	ED16MR-GY	EF16MR-BK	EF16MR-GY	.08 - .24 (2 - 6)							
ED20MA-BK	ED20MA-GY	EF20MA-BK	EF20MA-GY	.24 - .47 (6 - 12)	M20 X 1.5	.79 (20)	2.24 (57)	4.69 (119)	1.20 (30.5)	.35 (9)	.94 (24)
ED20MR-BK	ED20MR-GY	EF20MR-BK	EF20MR-GY	.20 - .35 (5 - 9)							
ED25MA-BK	ED25MA-GY	EF25MA-BK	EF25MA-GY	.51 - .71 (13 - 18)	M25 X 1.5	.98 (25)	2.87 (73)	6.14 (156)	1.57 (40)	.43 (11)	1.30 (33)
ED25MR-BK	ED25MR-GY	EF25MR-BK	EF25MR-GY	.35 - .63 (9 - 16)							
ED32MA-BK	ED32MA-GY	-	-	.71 - .98 (18 - 25)	M32 X 1.5	1.26 (32)	3.58 (91)	-	2.03 (51.5)	.43 (11)	1.65 (42)
ED32MR-BK	ED32MR-GY	-	-	.51 - .79 (13 - 20)							

*Metric and PG thread elbows include an O-Ring
 *VDE rating applies to Metric Dome Fittings only.

Liquid Tight Elbow Strain Relief Fitting for space and time saving applications.

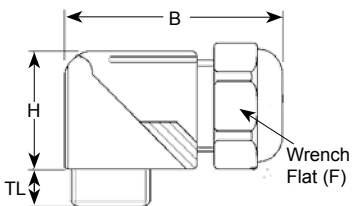

Suggested Clearance Hole for Non-Threaded Mounting

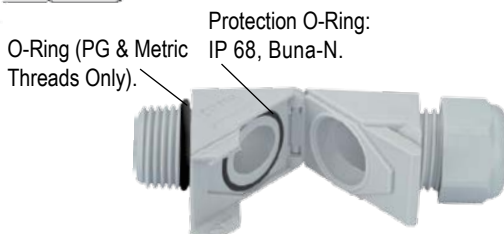
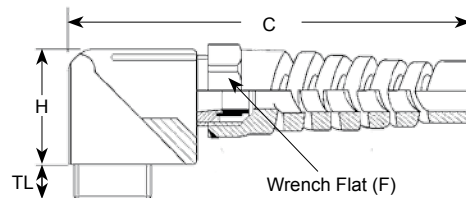

Optional Locking Nuts, O-Rings & Other Accessories starting on Page 29 - 40.

For Material Specifications and Approval Information refer to page 52.



**Liquid Tight Strain Relief Fitting
with Anodized Aluminum Clamp for
Extra Pull-out Resistance!**

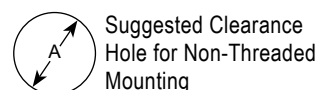
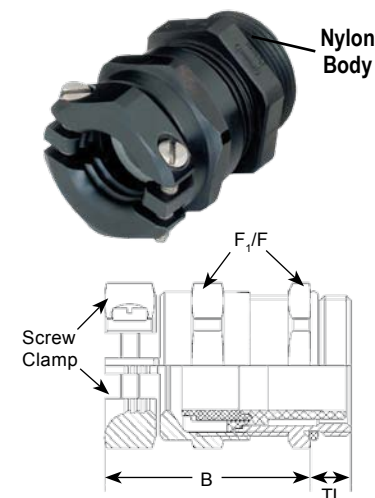

*Clamp Fitting includes Buna-N O-Ring

Extra Pull-Out Resistant Strain Relief Fittings with Clamp						
Part Numbers	Cable Range	Thread Type & Size	Dimensions in Inches (mm)			
			A	B	TL	F ₁ /F
 -4°F to 158°F (-20°C to 70°C)	Inches (mm)	See page 56 for thread specs	Clearance Hole	Body Length	Thread Length	Wrench Flats
			+ .01" (+.25 mm)			
CD09AA-CP	.16 - .31 (4 - 8)	PG 9	.60 (15.2)	1.14 (29)	.59 (15)	.75 (19)
CD11AA-CP	.24 - .39 (6 - 10)	PG 11	.73 (18.5)	1.28 (32.5)	.59 (15)	.87 (22)
CD13AA-CP	.24 - .47 (6 - 12)	PG 13 / 13.5	.80 (20.3)	1.40 (35.5)	.59 (15)	.94 (24)
CD16AA-CP	.39 - .55 (10 - 14)	PG 16	.89 (22.5)	1.48 (37.5)	.39 (10)	1.06 (27)
CD21AA-CP	.51 - .71 (13 - 18)	PG 21	1.12 (28.4)	1.61 (41)	.43 (11)	1.30 (33)
CD29AA-CP	.71 - .98 (18-25)	PG 29	1.47 (37.3)	1.93 (49)	.43 (11)	1.65 (42)
CD36AA-CP	.87 - 1.26 (22 - 32)	PG 36	1.85 (47)	2.28 (58)	.51 (13)	2.09 (53)
CD42AA-CP	1.26 - 1.50 (32 - 38)	PG 42	2.13 (54.1)	2.42 (61.5)	.51 (13)	2.36 (60)
CD48AA-CP	1.46 - 1.73 (37 - 44)	PG 48	2.34 (59.4)	2.44 (62)	.55 (14)	2.56 (65)
CD16MA-CP	.16 - .31 (4 - 8)	M16 X 1.5	.63 (16)	1.14 (29)	.59 (15)	.75 (19)
CD20MA-CP	.24 - .47 (6 - 12)	M20 X 1.5	.79 (20)	1.40 (35.5)	.59 (15)	.94 (24)
CD25MA-CP	.51 - .71 (13 - 18)	M25 X 1.5	.98 (25)	1.61 (41)	.43 (11)	1.30 (33)
CD32MA-CP	.71 - .98 (18-25)	M32 X 1.5	1.26 (32)	1.93 (49)	.43 (11)	1.65 (42)
CD40MA-CP	.87 - 1.26 (22 - 32)	M40 X 1.5	1.57 (40)	2.28 (58)	.51 (13)	2.09 (53)
CD50MA-CP	1.26 - 1.50 (32 - 38)	M50 X 1.5	1.97 (50)	2.42 (61.5)	.51 (13)	2.36 (60)
CD63MA-CP	1.46 - 1.73 (37 - 44)	M63 X 1.5	2.48 (63)	2.44 (62)	.55 (14)	2.56 (65) / 2.68 (68)

Nylon Strain Relief

Romex® fittings are also available in
PG 29, PG 36, PG 42, PG 48, 1/4", 1/2", M32, M40, M50, M63.

Nylon Liquid Tight Strain Relief Fittings ROMEX® - PG / NPT / Metric Threads

Romex® Strain Relief Fittings for Flat Cable									
Part Numbers	Slot Size	Thread Type & Size	Dimensions in Inches (mm)						
			A	B	TL	F ₁ /F			
 -40°F to 212°F (-40°C to 100°C)	Inches (mm)	See page 56 for thread specs	Clearance Hole	Body Length	Thread Length	Wrench Flats			
			+ .01" (+.25 mm)						
CD13AS-A1*	-	CD13AS-B1	.17 x .41 (4.2 x 10.4)	PG 13 / 13.5	.80 (20.3)	1.06 (27)	.35 (9)	.94 (24)	
CD16AS-01	CD16AS-02	CD16AS-B1	.24 x .55 (6 x 14)	PG 16	.89 (22.5)	1.10 (28)	.39 (10)	1.06 (27)	
CD16AS-03	CD16AS-04	CD16AS-B3	.20 x .45 (5 x 11.5)		.89 (22.5)	1.10 (28)	.39 (10)	1.06 (27)	
CD16AS-05	CD16AS-06	CD16AS-B2	.28 x .47 (7 x 12)		.89 (22.5)	1.10 (28)	.39 (10)	1.06 (27)	
CD21AS-01	CD21AS-02	CD21AS-B1	.24 x .55 (6 x 14)	PG 21	1.12 (28.4)	1.22 (31)	.43 (11)	1.30 (33)	
CD21AS-03	CD21AS-04	CD21AS-B2	.28 x .55 (7 x 14)		1.12 (28.4)	1.22 (31)	.43 (11)	1.30 (33)	
CD13NS-A1*	-	CD13NS-B1	.17 x .41 (4.2 x 10.4)	1/2" - E NPT	.83 (21.1)	1.06 (27)	.51 (13)	.94 (24)	
CD16NS-01	CD16NS-02	CD16NS-B1	.24 x .55 (6 x 14)		.83 (21.1)	1.10 (28)	.51 (13)	1.06 (27)	
CD16NS-03	CD16NS-04	CD16NS-B3	.20 x .45 (5 x 11.5)		.83 (21.1)	1.10 (28)	.51 (13)	1.06 (27)	
CD16NS-05	CD16NS-06	CD16NS-B2	.28 x .47 (7 x 12)		.83 (21.1)	1.10 (28)	.51 (13)	1.06 (27)	
CD21NS-01	CD21NS-02	CD21NS-B1	.24 x .55 (6 x 14)		3/4" NPT	1.05 (26.7)	1.22 (31)	.55 (14)	1.30 (33)
CD21NS-03	CD21NS-04	CD21NS-B2	.28 x .55 (7 x 14)	1.05 (26.7)		1.22 (31)	.55 (14)	1.30 (33)	
CD29NS-01	-	CD29NS-B1	.31 x .87 (8 x 22)	1" NPT	1.35 (34.3)	1.54 (39)	.75 (19)	1.65 (42)	
CD20MS-A1*	-	-	.17 x .41 (4.2 x 10.4)	-	.79 (20)	1.06 (27)	.35 (9)	.94 (24)	
CD20MS-01	CD20MS-02	CD20MS-B1	.24 x .55 (6 x 14)		M20 X 1.5	.79 (20)	1.10 (28)	.35 (9)	1.06 (27)
CD20MS-03	CD20MS-04	CD20MS-B3	.20 x .45 (5 x 11.5)			.79 (20)	1.10 (28)	.35 (9)	1.06 (27)
CD20MS-05	CD20MS-06	CD20MS-B2	.28 x .47 (7 x 12)	.79 (20)		1.10 (28)	.35 (9)	1.06 (27)	
CD25MS-01	CD25MS-02	CD25MS-B1	.24 x .55 (6 x 14)	M25 X 1.5	.98 (25)	1.22 (31)	.43 (11)	1.30 (33)	
CD25MS-03	CD25MS-04	CD25MS-B2	.28 x .55 (7 x 14)		.98 (25)	1.22 (31)	.43 (11)	1.30 (33)	

Strain Relief Fittings with Inserts for Flat Cables and ASI-BUS Cables. These form seals are also available with Strain Relief Fittings made of other materials. (Nickel Plated Brass, Stainless Steel, etc.). UL pertains to the standard body, not including FLAKA (Romex®) Insert. FLAKA (for Romex style cable) HSK-K 1/2"-E are UL listed. To meet UL, only Romex style cable (flat top and bottom) can be used with this style Strain Relief (no Zip Cable, no Ribbon cable, etc.).

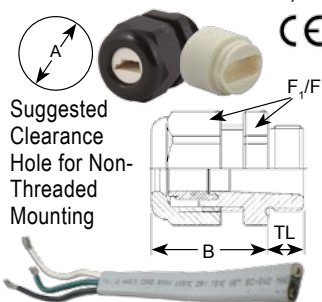

* UL f1 rating applies to Black Nylon Fittings only.
* Insert for ASI-BUS Cables
Romex® is a federally registered trademark of Southwire Company.

Nylon Liquid Tight Strain Relief Fittings Multi-Hole - PG Threads



Multi-Hole Inserts are available in Silicone and FKM upon request.



Optional Locking Nuts,
O-Rings & Other
Accessories starting
on Page 29 - 40.

Nylon Strain Relief

Part Numbers		Thread Type & Size	Dimensions in Inches (mm)			Part Numbers of Inserts Only	
-40°F to 212°F (-40°C to 100°C)			No. of Holes	Diameter of Holes			
Black	Gray	See page 56 for thread specs		mm	Inches		
CD07AP-BK	CD07AP-GY	PG 7/ 1/4" NPT	Solid Insert		1.089.0799.19		
CD09A1-BK	CD09A1-GY	PG 9	4	1.4	.06	1.089.0900.19	
CD09A2-BK	CD09A2-GY		2	3.0	.12	1.089.0901.19	
CD09A3-BK	CD09A3-GY		5	1.6	.06	1.089.0902.19	
CD09A4-BK	CD09A4-GY		2	1.7	.07	1.089.0903.19	
CD09A5-BK	CD09A5-GY		10	1.4	.06	1.089.0904.19	
CD09A6-BK	CD09A6-GY		6	1.4	.06	1.089.0905.19	
CD09A7-BK	CD09A7-GY		3	1.7	.07	1.089.0906.19	
CD09A8-BK	CD09A8-GY		4	1.7	.07	1.089.0907.19	
CD09A9-BK	CD09A9-GY		4	2.3	.09	1.089.0908.19	
CD09AP-BK	CD09AP-GY		Solid Insert		1.089.0999.19		
CD11A1-BK	CD11A1-GY		PG 11	2	3.0	.12	1.089.1100.19
CD11A2-BK	CD11A2-GY			3	3.0	.12	1.089.1101.19
CD11A3-BK	CD11A3-GY	2		4.0	.16	1.089.1102.19	
CD11A4-BK	CD11A4-GY	3		1.5	.06	1.089.1103.19	
CD11A5-BK	CD11A5-GY	4		2.8	.11	1.089.1104.19	
CD11AP-BK	CD11AP-GY	Solid Insert		1.089.1199.19			
CD13A1-BK	CD13A1-GY	PG 13 / 13.5	3	2.0	.08	1.089.1300.19	
CD13A2-BK	CD13A2-GY		6	3.0	.12	1.089.1301.19	
CD13A3-BK	CD13A3-GY		3	4.0	.16	1.089.1302.19	
CD13A4-BK	CD13A4-GY		2	5.0	.20	1.089.1303.19	
CD13A5-BK	CD13A5-GY		3	3.0	.12	1.089.1304.19	
CD13A6-BK	CD13A6-GY		2	5.2	.20	1.089.1305.19	
CD13A7-BK	CD13A7-GY		2	3.8	.15	1.089.1306.19	
CD13A8-BK	CD13A8-GY		2	4.2	.17	1.089.1307.19	
CD13A9-BK	CD13A9-GY		2	2.5	.10	1.089.1308.19	
CD13AP-BK	CD13AP-GY		Solid Insert		1.089.1399.19		
CD16A1-BK	CD16A1-GY		PG 16	3	3.0	.12	1.089.1600.19
CD16A2-BK	CD16A2-GY			3	4.0	.16	1.089.1601.19
CD16A3-BK	CD16A3-GY	4		4.0	.16	1.089.1602.19	
CD16A4-BK	CD16A4-GY	5		4.0	.16	1.089.1603.19	
CD16A5-BK	CD16A5-GY	6		4.0	.16	1.089.1604.19	
CD16A6-BK	CD16A6-GY	2		6.0	.24	1.089.1605.19	
CD16A7-BK	CD16A7-GY	3		5.6	.22	1.089.1606.19	
CD16A8-BK	CD16A8-GY	6		3.0	.12	1.089.1607.19	
CD16A9-BK	CD16A9-GY	*4		3.0	.12	*1.089.1610.19	
CD16A0-BK	CD16A0-GY	6		3.8	.15	1.089.1609.19	
CD16AP-BK	CD16AP-GY	Solid Insert		1.089.1699.19			

Part Numbers		Thread Type & Size	Dimensions in Inches (mm)			Part Numbers of Inserts Only	
-40°F to 212°F (-40°C to 100°C)			No. of Holes	Diameter of Holes			
Black	Gray	See page 56 for thread specs		mm	Inches		
CD21A1-BK	CD21A1-GY	PG 21	4	6.0	.24	1.089.2100.19	
CD21A2-BK	CD21A2-GY		3	7.0	.28	1.089.2101.19	
CD21A3-BK	CD21A3-GY		2	8.0	.31	1.089.2102.19	
CD21A4-BK	CD21A4-GY		4	5.0	.20	1.089.2103.19	
CD21A5-BK	CD21A5-GY		1	8.0	.31	1.089.2104.19	
CD21A6-BK	CD21A6-GY		4	5.2	.20	1.089.2105.19	
CD21A7-BK	CD21A7-GY		3	5.2	.20	1.089.2106.19	
CD21A8-BK	CD21A8-GY		4 / 1	5.2/3.7	.20/.15	1.089.2107.19	
CD21A9-BK	CD21A9-GY		2	7.4	.29	1.089.2108.19	
CD21AP-BK	CD21AP-GY		Solid Insert		1.089.2199.19		
CD29A1-BK	CD29A1-GY		PG 29	6	6.5	.26	1.089.2900.19
CD29A2-BK	CD29A2-GY			4	9.0	.35	1.089.2901.19
CD29A3-BK	CD29A3-GY	4		9.5	.37	1.089.2902.19	
CD29A9-BK	CD29A9-GY	2		11.0	.43	1.089.2908.19	
CD29AP-BK	CD29AP-GY	Solid Insert		1.089.2999.19			
CD36A1-BK	CD36A1-GY	PG 36	5	9.0	.35	1.089.3600.19	
CD36A2-BK	CD36A2-GY		7	9.0	.35	1.089.3601.19	
CD36A3-BK	CD36A3-GY		6	8.0	.31	1.089.3602.19	
CD36A4-BK	CD36A4-GY		2	15.0	.59	1.089.3603.19	
CD36AP-BK	CD36AP-GY		Solid Insert		1.089.3699.19		
CD42A1-BK	CD42A1-GY	PG 42	3	14.0	.55	1.089.4203.19	
CD42AP-BK	CD42AP-GY		Solid Insert		1.089.4299.19		
CD48A1-BK	CD48A1-GY	PG 48	8	10.0	.39	1.089.4800.19	
CD48A2-BK	CD48A2-GY		6	12.0	.47	1.089.4801.19	
CD48A3-BK	CD48A3-GY		3	18.0	.71	1.089.4802.19	
CD48AP-BK	CD48AP-GY		Solid Insert		1.089.4899.19		

RJ45 Solution

Part Numbers		Thread Type & Size	Dimensions in Inches (mm)		Part Numbers of Inserts Only
-40°F to 212°F (-40°C to 100°C)			Cable Diameter		
Black	Gray	See page 56 for thread specs	mm	Inches	
CD16AK-BK	CD16AK-GY	PG 16	5.7	.23	1.089.16C-06
CD16AJ-BK	CD16AJ-GY		6.9	.27	1.089.16C-07

*RJ45 Solution has no approval ratings. NPT available on page 11. Metric available on page 12. Reference Diagram on page 12.

*UL F1 (746C) rating applies to Black Nylon Fittings only.

*This Insert has slotted holes.

Dome Fittings also available with the following approvals:



www.SealconEX.com

Fittings with Multi-Hole Inserts also available with a Flex Nut.

To order, substitute "CF" for "CD"

(e.g. CD09A1-BK becomes CF09A1-BK)

For Strain Relief Specifications and Dimensions refer to page 24.

"BP"
(Billet Plugs)
available upon request.





Nylon Strain Relief

Part Numbers		Thread Type & Size	Dimensions in Inches (mm)			Part Numbers of Inserts Only	
-40°F to 212°F (-40°C to 100°C)			No. of Holes	Diameter of Holes			
Black	Gray	See page 56 for thread specs		mm	Inches		
CD07NP-BK	CD07NP-GY		PG 7 / 1/4" NPT	Solid Insert			1.089.0799.19
CD09N1-BK	CD09N1-GY	3/8" NPT	4	1.4	.06	1.089.0900.19	
CD09N2-BK	CD09N2-GY		2	3.0	.12	1.089.0901.19	
CD09N3-BK	CD09N3-GY		5	1.6	.06	1.089.0902.19	
CD09N4-BK	CD09N4-GY		2	1.7	.07	1.089.0903.19	
CD09N5-BK	CD09N5-GY		10	1.4	.06	1.089.0904.19	
CD09N6-BK	CD09N6-GY		6	1.4	.06	1.089.0905.19	
CD09N7-BK	CD09N7-GY		3	1.7	.07	1.089.0906.19	
CD09N8-BK	CD09N8-GY		4	1.7	.07	1.089.0907.19	
CD09N9-BK	CD09N9-GY		4	2.3	.09	1.089.0908.19	
CD09NP-BK	CD09NP-GY		Solid Insert			1.089.0999.19	
CD13N1-BK	CD13N1-GY		1/2" NPT	3	2.0	.08	1.089.1300.19
CD13N2-BK	CD13N2-GY			6	3.0	.12	1.089.1301.19
CD13N3-BK	CD13N3-GY	3		4.0	.16	1.089.1302.19	
CD13N4-BK	CD13N4-GY	2		5.0	.20	1.089.1303.19	
CD13N5-BK	CD13N5-GY	3		3.0	.12	1.089.1304.19	
CD13N6-BK	CD13N6-GY	2		5.2	.20	1.089.1305.19	
CD13N7-BK	CD13N7-GY	2		3.8	.15	1.089.1306.19	
CD13N8-BK	CD13N8-GY	2		4.2	.17	1.089.1307.19	
CD13N9-BK	CD13N9-GY	2		2.5	.10	1.089.1308.19	
CD13NP-BK	CD13NP-GY	Solid Insert			1.089.1399.19		
CD16N1-BK	CD16N1-GY	1/2" NPT (Enlarged)		3	3.0	.12	1.089.1600.19
CD16N2-BK	CD16N2-GY			3	4.0	.16	1.089.1601.19
CD16N3-BK	CD16N3-GY		4	4.0	.16	1.089.1602.19	
CD16N4-BK	CD16N4-GY		5	4.0	.16	1.089.1603.19	
CD16N5-BK	CD16N5-GY		6	4.0	.16	1.089.1604.19	
CD16N6-BK	CD16N6-GY		2	6.0	.24	1.089.1605.19	
CD16N7-BK	CD16N7-GY		3	5.6	.22	1.089.1606.19	
CD16N8-BK	CD16N8-GY		6	3.0	.12	1.089.1607.19	
CD16N9-BK	CD16N9-GY		*4	3.0	.12	*1.089.1610.19	
CD16N0-BK	CD16N0-GY		6	3.8	.15	1.089.1609.19	
CD16NP-BK	CD16NP-GY		Solid Insert			1.089.1699.19	

*UL f1(746C) rating applies to Black Nylon Fittings only.

*This Insert has slotted holes.

Fittings with Multi-Hole Inserts are also available with a Flex Nut

- To order, substitute "CF" for "CD" (e.g. CD09N1-BK becomes CF09N1-BK)

Custom Solutions!

- Any custom hole configuration is available for a minimum order of 1,000 pieces.
- No charge for standard delivery time. For quicker delivery of 6-8 weeks, a one time Expedite fee will be accessed.
- "BP" (Billet Plugs) available upon request.

Dome Fittings also available with the following approvals:



www.SealconEX.com



New UV & Ozone Stable Black TPE Membrane available (60 Different Configurations). Call for details.

Part Numbers		Thread Type & Size	Dimensions in Inches (mm)			Part Numbers of Inserts Only	
-40°F to 212°F (-40°C to 100°C)			No. of Holes	Diameter of Holes			
Black	Gray	See page 56 for thread specs		mm	Inches		
CD21N1-BK	CD21N1-GY		3/4" NPT	4	6.0		.24
CD21N2-BK	CD21N2-GY	3		7.0	.28	1.089.2101.19	
CD21N3-BK	CD21N3-GY	2		8.0	.31	1.089.2102.19	
CD21N4-BK	CD21N4-GY	4		5.0	.20	1.089.2103.19	
CD21N5-BK	CD21N5-GY	1		8.0	.31	1.089.2104.19	
CD21N6-BK	CD21N6-GY	4		5.2	.20	1.089.2105.19	
CD21N7-BK	CD21N7-GY	3		5.2	.20	1.089.2106.19	
CD21N8-BK	CD21N8-GY	4/1		5.2/3.7	.20/.15	1.089.2107.19	
CD21N9-BK	CD21N9-GY	2		7.4	.29	1.089.2108.19	
CD21NP-BK	CD21NP-GY	Solid Insert			1.089.2199.19		
CD29N1-BK	CD29N1-GY	1" NPT		6	6.5	.26	1.089.2900.19
CD29N2-BK	CD29N2-GY			4	9.0	.35	1.089.2901.19
CD29N3-BK	CD29N3-GY		4	9.5	.37	1.089.2902.19	
CD29N9-BK	CD29N9-GY		2	11.0	.43	1.089.2908.19	
CD29NP-BK	CD29NP-GY	Solid Insert			1.089.2999.19		
CD29L1-BK	CD29L1-GY	1-1/4" NPT	6	6.5	.26	1.089.2900.19	
CD29L2-BK	CD29L2-GY		4	9.0	.35	1.089.2901.19	
CD29L3-BK	CD29L3-GY		4	9.5	.37	1.089.2902.19	
CD29LP-BK	CD29LP-GY		Solid Insert			1.089.2999.19	
CD36N1-BK	CD36N1-GY	1-1/2" NPT	5	9.0	.35	1.089.3600.19	
CD36N2-BK	CD36N2-GY		7	9.0	.35	1.089.3601.19	
CD36N3-BK	CD36N3-GY		6	8.0	.31	1.089.3602.19	
CD36N4-BK	CD36N4-GY		2	15.0	.59	1.089.3603.19	
CD36NP-BK	CD36NP-GY	Solid Insert			1.089.3699.19		

RJ45 Solution

Part Numbers		Thread Type & Size	Dimensions in Inches (mm)		Part Numbers of Inserts Only
-40°F to 212°F (-40°C to 100°C)			Cable Diameter		
Black	Gray	See page 56 for thread specs	mm	Inches	
CD16NK-BK	CD16NK-GY		1/2" E-NPT	5.7	
CD16NJ-BK	CD16NJ-GY	6.9		.27	1.089.16C-07

*RJ45 Solution has no approval ratings. Reference Diagram on page 12.

Important:

Design Parameters: Cable diameter should not be less than 80% of hole diameter and the difference between hole and cable diameter should never exceed .04" (1 mm). The Multi Cable fittings will meet Type NEMA 4x = IP 65 if the design parameters are complied with.

To verify a submersible Type NEMA 6 = IP 68 application, the final assembly of cables and fittings must be tested by the customer or submitted at the customer's expense to an independent test lab.

Nylon Liquid Tight Strain Relief Fittings

Multi-Hole - Metric Threads



Nylon Strain Relief

Part Numbers		Thread Type & Size	Dimensions in Inches (mm)			Part Numbers of Inserts Only	
-40°F to 212°F (-40°C to 100°C)			No. of Holes	Diameter of Holes			
Black	Gray	See page 56 for thread specs		mm	Inches		
CD12MP-BK	CD12MP-GY		M12 X 1.5	Solid Insert			1.089.0799.19
CD16M1-BK	CD16M1-GY	M16 X 1.5	4	1.4	.06	1.089.0900.19	
CD16M2-BK	CD16M2-GY		2	3.0	.12	1.089.0901.19	
CD16M3-BK	CD16M3-GY		5	1.6	.06	1.089.0902.19	
CD16M4-BK	CD16M4-GY		2	1.7	.07	1.089.0903.19	
CD16M5-BK	CD16M5-GY		10	1.4	.06	1.089.0904.19	
CD16M6-BK	CD16M6-GY		6	1.4	.06	1.089.0905.19	
CD16M7-BK	CD16M7-GY		3	1.7	.07	1.089.0906.19	
CD16M8-BK	CD16M8-GY		4	1.7	.07	1.089.0907.19	
CD16M9-BK	CD16M9-GY		4	2.3	.09	1.089.0908.19	
CD16MP-BK	CD16MP-GY		Solid Insert			1.089.0999.19	
CD17M1-BK	CD17M1-GY		M16 X 1.5 (Enlarged)	2	3.0	.12	1.089.1100.19
CD17M2-BK	CD17M2-GY			3	3.0	.12	1.089.1101.19
CD17M3-BK	CD17M3-GY			2	4.0	.16	1.089.1102.19
CD17M4-BK	CD17M4-GY	3		1.5	.06	1.089.1103.19	
CD17M5-BK	CD17M5-GY	4		2.8	.11	1.089.1104.19	
CD17MP-BK	CD17MP-GY	Solid Insert			1.089.1199.19		
CD20M1-BK	CD20M1-GY	M20 X 1.5	3	2.0	.08	1.089.1300.19	
CD20M2-BK	CD20M2-GY		6	3.0	.12	1.089.1301.19	
CD20M3-BK	CD20M3-GY		3	4.0	.16	1.089.1302.19	
CD20M4-BK	CD20M4-GY		2	5.0	.20	1.089.1303.19	
CD20M5-BK	CD20M5-GY		3	3.0	.12	1.089.1304.19	
CD20M6-BK	CD20M6-GY		2	5.2	.20	1.089.1305.19	
CD20M7-BK	CD20M7-GY		2	3.8	.15	1.089.1306.19	
CD20M8-BK	CD20M8-GY		2	4.2	.17	1.089.1307.19	
CD20M9-BK	CD20M9-GY		2	2.5	.10	1.089.1308.19	
CD20MP-BK	CD20MP-GY		Solid Insert			1.089.1399.19	
CD22M1-BK	CD22M1-GY		M20 X 1.5 (Enlarged)	3	3.0	.12	1.089.1600.19
CD22M2-BK	CD22M2-GY	3		4.0	.16	1.089.1601.19	
CD22M3-BK	CD22M3-GY	4		4.0	.16	1.089.1602.19	
CD22M4-BK	CD22M4-GY	5		4.0	.16	1.089.1603.19	
CD22M5-BK	CD22M5-GY	6		4.0	.16	1.089.1604.19	
CD22M6-BK	CD22M6-GY	2		6.0	.24	1.089.1605.19	
CD22M7-BK	CD22M7-GY	3		5.6	.22	1.089.1606.19	
CD22M8-BK	CD22M8-GY	6		3.0	.12	1.089.1607.19	
CD22M9-BK	CD22M9-GY	*4		3.0	.12	*1.089.1610.19	
CD22M0-BK	CD22M0-GY	6		3.8	.15	1.089.1609.19	
CD22MP-BK	CD22MP-GY	Solid Insert			1.089.1699.19		

***This Insert has slotted holes.**

***UL f1 (746C) rating applies to Black Nylon Fittings only.**

Fittings with Multi-Hole Inserts are also available with a Flex Nut.

To order, substitute "CF" for "CD" (e.g. CD16M1-BK becomes CF16M1-BK).

"BP" (Billet Plugs) available upon request.

Custom Solutions for terminated cable!

For Strain Relief Specifications and Dimensions refer to page 5.
For Material Specifications and Approval Information refer to page 52.

Part Numbers		Thread Type & Size	Dimensions in Inches (mm)			Part Numbers of Inserts Only	
-40°F to 212°F (-40°C to 100°C)			No. of Holes	Diameter of Holes			
Black	Gray	See page 56 for thread specs		mm	Inches		
CD25M1-BK	CD25M1-GY		M25 X 1.5	4	6.0		.24
CD25M2-BK	CD25M2-GY	3		7.0	.28	1.089.2101.19	
CD25M3-BK	CD25M3-GY	2		8.0	.31	1.089.2102.19	
CD25M4-BK	CD25M4-GY	4		5.0	.20	1.089.2103.19	
CD25M5-BK	CD25M5-GY	1		8.0	.31	1.089.2104.19	
CD25M6-BK	CD25M6-GY	4		5.2	.20	1.089.2105.19	
CD25M7-BK	CD25M7-GY	3		5.2	.20	1.089.2106.19	
CD25M8-BK	CD25M8-GY	4/1		5.2/3.7	.20/.15	1.089.2107.19	
CD25M9-BK	CD25M9-GY	2		7.4	.29	1.089.2108.19	
CD25MP-BK	CD25MP-GY	Solid Insert			1.089.2199.19		
CD32M1-BK	CD32M1-GY	M32 X 1.5		6	6.5	.26	1.089.2900.19
CD32M2-BK	CD32M2-GY			4	9.0	.35	1.089.2901.19
CD32M3-BK	CD32M3-GY			4	9.5	.37	1.089.2902.19
CD32MP-BK	CD32MP-GY		Solid Insert			1.089.2999.19	
CD40M1-BK	CD40M1-GY	M40 X 1.5	5	9.0	.35	1.089.3600.19	
CD40M2-BK	CD40M2-GY		7	9.0	.35	1.089.3601.19	
CD40M3-BK	CD40M3-GY		6	8.0	.31	1.089.3602.19	
CD40M4-BK	CD40M4-GY		2	15.0	.59	1.089.3603.19	
CD40MP-BK	CD40MP-GY		Solid Insert			1.089.3699.19	
CD50M1-BK	CD50M1-GY	M50 X 1.5	3	14.0	.55	1.089.4203.19	
CD50MP-BK	CD50MP-GY		Solid Insert			1.089.4299.19	
CD63M1-BK	CD63M1-GY	M63 X 1.5	8	10.0	.39	1.089.4800.19	
CD63M2-BK	CD63M2-GY		6	12.0	.47	1.089.4801.19	
CD63M3-BK	CD63M3-GY		3	18.0	.71	1.089.4802.19	
CD63MP-BK	CD63MP-GY		Solid Insert			1.089.4899.19	

RJ45 Solution

Part Numbers		Thread Type & Size	Dimensions in Inches (mm)		Part Numbers of Inserts Only
-40°F to 212°F (-40°C to 100°C)			Cable Diameter		
Black	Gray	See page 56 for thread specs	mm	Inches	
CD22MK-BK	CD22MK-GY		M20	5.7	
CD22MJ-BK	CD22MJ-GY	(Enlarged)	6.9	.27	1.089.16C-07

***RJ45 Solution has no approval ratings. Reference Diagram below.**

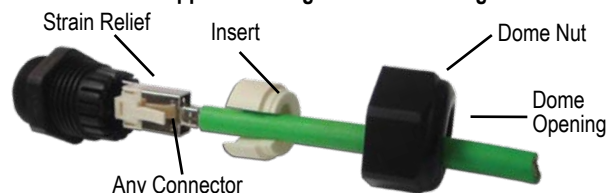

Dome Fittings also available with the following approvals:



www.SealconEX.com



Optional Locking Nuts, O-Rings & Other Accessories starting on Page 29 - 40.

Features & Benefits:

- Type NEMA 4x & 6 (IP 67 & 68) - Liquid Tight - Submersible to 300 ft!
- IP 69K rated - Ideal in splash or hose down applications!
- Patented Form Seal allows 150 PSIG (10 BAR) rating - Highest in Industry!
- V0 flame rating according to UL 94 (Dome Nylon & PVDF Only) - Phosphorous Free - Non-Toxic!
- Concentric O-Ring Groove - meets most Type NEMA applications!
- Safety Ratchet Top Cap - Preventing Dome/Flex top from coming loose under vibration!
- Large selection - Cable Range from .08" (2 mm) to 1.73" (44 mm).
- Non-Corrosive - Resistant to salt water, weak acids, weak alkalis, alcohol, esters, ketones, ether, gasoline, mineral, animal & vegetable oil.
- Durable - Rugged Construction.
- RoHS & Deca BDE - Environmentally Compliant to the newest standards!

UL/UR	E103997
CSA	074032
VDE	71339
CAGE	0 UE11
PATENT	4145075



Clamping:
Extra Pull-Out Resistant
Strain Relief Fittings

Unique Product!



Pull-out Resistance & Cable Protection

Overlapping clamping splines apply a concentric pressure, thereby preventing the form seal (grommet) from being pulled out of the fitting. This ensures pull-out protection without damage to the cable.

Submersible

The patented internal sealing edge results in a superior seal between the splined Nylon clamping insert and Nickel Plated Brass body.

Unique Product

The patented recess and high performance form seal guarantees Type NEMA 4x & 6 (IP 68 / IP 69K) at 150 PSIG (10 bar).

Liquid Tight

All of our Nickel Plated Brass parts come with an O-Ring, which makes your application liquid tight, allowing submersion up to 300 ft.

Easy Installation

The anti-rotation grooves between body and spline insert prevent cable rotation while tightening the nut.

Time Saving Installation

Simply push the cable through Strain Relief Fitting - Tighten Dome or Flex Nut - Done! No disassembly of the Fitting required!



Standard, Reduced and Multi-Hole Inserts

Modularity: Increase and decrease cable opening by swapping out inserts to accommodate various cable sizes & configurations.



Flex Nut

The 304 Stainless Steel spring extension offers superior protection against kinking and chafing of the cable in dynamic applications.

Nickel Plated Brass Liquid Tight Strain Relief Fittings

Standard - PG / NPT / Metric Threads



Nickel Plated Brass

Part Numbers		Cable Range	Thread Type & Size	Dimensions in Inches (mm)				
-40°F to 212°F (-40°C to 100°C)				A	B	C	TL	F _i /F
Dome	Flex	Inches (mm)	See Page 56 for thread specs	Clearance Hole +.01" (+.25 mm)	Body Length (Dome)	Body Length (Flex)	Thread Length	Wrench Flats
CD07AA-BR	CF07AA-BR	.12 - .26 (3 - 6.5)	PG 7 / 1/4" NPT	.49 (12.5)	.75 (19)	2.17 (55)	.20 (5)	.55 (14)
CD07AR-BR	CF07AR-BR	.08 - .20 (2 - 5)						
CD09AA-BR	CF09AA-BR	.16 - .31 (4 - 8)	PG 9	.60 (15.2)	.83 (21)	2.60 (66)	.24 (6)	.67 (17)
CD09AR-BR	CF09AR-BR	.08 - .24 (2 - 6)						
CD11AA-BR	CF11AA-BR	.20 - .39 (5 - 10)	PG 11	.73 (18.5)	.87 (22)	3.03 (77)	.24 (6)	.79 (20)
CD11AR-BR	CF11AR-BR	.12 - .28 (3 - 7)						
CD13AA-BR	CF13AA-BR	.24 - .47 (6 - 12)	PG 13 / 13.5	.80 (20.3)	.94 (24)	3.46 (88)	.26 (6.5)	.87 (22)
CD13AR-BR	CF13AR-BR	.20 - .35 (5 - 9)						
CD16AA-BR	CF16AA-BR	.39 - .55 (10 - 14)	PG 16	.89 (22.5)	.91 (23)	3.86 (98)	.26 (6.5)	.94 (24)
CD16AR-BR	CF16AR-BR	.28 - .47 (7-12)						
CD21AA-BR	CF21AA-BR	.51 - .71 (13 - 18)	PG 21	1.12 (28.4)	.94 (24)	4.37 (111)	.28 (7)	1.18 (30)
CD21AR-BR	CF21AR-BR	.35 - .63 (9 - 16)						
CD29AA-BR	-	.71 - .98 (18 - 25)	PG 29	1.47 (37.3)	1.14 (29)	-	.31 (8)	1.57 (40)
CD29AR-BR	-	.51 - .79 (13 - 20)						
CD36AA-BR	-	.87 - 1.26 (22 - 32)	PG 36	1.85 (47)	1.38 (35)	-	.31 (8)	1.97 (50)
CD36AR-BR	-	.79 - 1.02 (20 - 26)						
CD42AA-BR	-	1.26 - 1.50 (32 - 38)	PG 42	2.13 (54.1)	1.46 (37)	-	.35 (9)	2.24 (57)
CD42AR-BR	-	.98 - 1.22 (25 - 31)						
CD48AA-BR	-	1.46 - 1.73 (37 - 44)	PG 48	2.34 (59.4)	1.50 (38)	-	.39 (10)	2.52 (64)
CD48AR-BR	-	1.14 - 1.38 (29 - 35)						
CD09NA-BR	CF09NA-BR	.16 - .31 (4 - 8)	3/8" NPT	.68 (17.2)	.83 (21)	2.60 (66)	.59 (15)	.67 (17) / .75 (19)
CD09NR-BR	CF09NR-BR	.08 - .24 (2 - 6)	1/2" NPT	.83 (21.1)	.94 (24)	3.46 (88)	.51 (13)	.87 (22) / .94 (24)
CD13NA-BR	CF13NA-BR	.24 - .47 (6 - 12)						
CD13NR-BR	CF13NR-BR	.20 - .35 (5 - 9)	1/2" NPT	.83 (21.1)	.94 (24)	3.89 (99)	.51 (13)	.94 (24)
CD16NA-BR	CF16NA-BR	.39 - .55 (10 - 14)						
CD16NR-BR	CF16NR-BR	.28 - .47 (7-12)	3/4" NPT	1.05 (26.7)	.98 (25)	4.37 (111)	.51 (13)	1.18 (30)
CD21NA-BR	CF21NA-BR	.51 - .71 (13 - 18)						
CD21NR-BR	CF21NR-BR	.35 - .63 (9 - 16)	1" NPT	1.35 (34.3)	1.14 (29)	-	.75 (19)	1.57 (40)
CD29NA-BR	-	.71 - .98 (18 - 25)						
CD29NR-BR	-	.51 - .79 (13 - 20)						
CD12MA-BR	CF12MA-BR	.12 - .26 (3 - 6.5)	M12 X 1.5	.47 (12)	.75 (19)	2.17 (55)	.26 (6.5)	.55 (14)
CD12MR-BR	CF12MR-BR	.08 - .20 (2 - 5)	M16 X 1.5	.63 (16)	.83 (21)	2.60 (66)	.24 (6)	.67 (17) Dome .75 (19) Flex
CD16MA-BR	CF16MA-BR	.16 - .31 (4 - 8)						
CD16MR-BR	CF16MR-BR	.08 - .24 (2 - 6)	M16 X 1.5	.63 (16)	.87 (22)	3.03 (77)	.24 (6)	.79 (20)
CD17MA-BR	CF17MA-BR	.20 - .39 (5 - 10)						
CD17MR-BR	CF17MR-BR	.08 - .24 (2 - 6)	M20 X 1.5	.79 (20)	.91 (23)	3.46 (88)	.24 (6)	.87 (22)
CD20MA-BR	CF20MA-BR	.24 - .47 (6 - 12)						
CD20MR-BR	CF20MR-BR	.20 - .35 (5 - 9)	M20 X 1.5	.79 (20)	.94 (24)	3.86 (98)	.24 (6)	.94 (24)
CD22MA-BR	CF22MA-BR	.39 - .55 (10 - 14)						
CD22MR-BR	CF22MR-BR	.28 - .47 (7-12)	M25 X 1.5	.98 (25)	1.02 (26)	4.37 (111)	.28 (7)	1.18 (30)
CD25MA-BR	CF25MA-BR	.51 - .71 (13 - 18)						
CD25MR-BR	CF25MR-BR	.35 - .63 (9 - 16)	M32 X 1.5	1.26 (32)	1.22 (31)	-	.31 (8)	1.57 (40)
CD32MA-BR	-	.71 - .98 (18 - 25)						
CD32MR-BR	-	.51 - .79 (13 - 20)	M40 X 1.5	1.57 (40)	1.46 (37)	-	.31 (8)	1.97 (50)
CD40MA-BR	-	.87 - 1.26 (22 - 32)						
CD40MR-BR	-	.79 - 1.02 (20 - 26)	M50 X 1.5	1.97 (50)	1.46 (37)	-	.35 (9)	2.24 (57)
CD50MA-BR	-	1.26 - 1.50 (32 - 38)						
CD50MR-BR	-	.98 - 1.22 (25 - 31)	M63 X 1.5	2.48 (63)	1.50 (38)	-	.39 (10)	2.52 (64) / 2.68 (68)
CD63MA-BR	-	1.46 - 1.73 (37 - 44)						
CD63MR-BR	-	1.14 - 1.38 (29 - 35)						



Optional Locking Nuts, O-Rings & Other Accessories starting on Page 29 - 40.

Dome Fittings also available with the following approvals:



www.SealconEX.com



Includes O-Ring

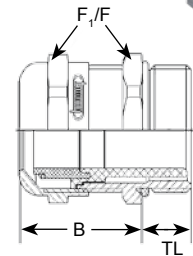

Suggested Clearance Hole for Non-Threaded Mounting

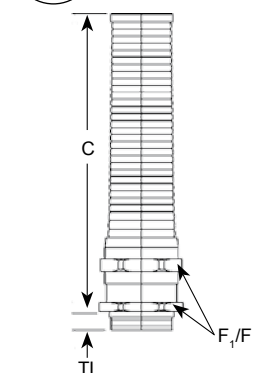

For Material Specifications and Approval Information refer to page 52.

Elongated thread is recommended where the Strain Relief has to pass through a thick wall or the application just needs the extra thread length.

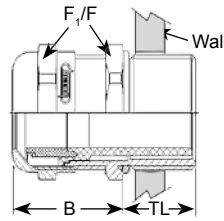

Suggested Clearance Hole for Non-Threaded Mounting

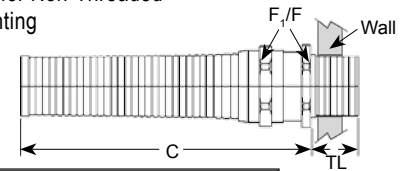

Part Numbers		Cable Range	Thread Type & Size	Dimensions in Inches (mm)				
-40°F to 212°F (-40°C to 100°C)				A	B	C	TL	F ₁ /F ₂
Dome Fittings	Flex Fittings	Inches (mm)	See page 56 for thread specs	Clearance Hole +.01" (+.25 mm)	Body Length (Dome)	Body Length (Flex)	Thread Length	Wrench Flats
				Elongated				
CD07CA-BR	CF07CA-BR	.12 - .26 (3 - 6.5)	PG 7	.49 (12.5)	.75 (19)	2.17 (55)	.39 (10)	.55 (14)
CD07CR-BR	CF07CR-BR	.08 - .20 (2 - 5)						
CD09CA-BR	CF09CA-BR	.16 - .31 (4 - 8)	PG 9	.60 (15.2)	.83 (21)	2.60 (66)	.39 (10)	.67 (17)
CD09CR-BR	CF09CR-BR	.08 - .24 (2 - 6)						
CD11CA-BR	CF11CA-BR	.20 - .39 (5 - 10)	PG 11	.73 (18.5)	.87 (22)	3.03 (77)	.39 (10)	.79 (20)
CD11CR-BR	CF11CR-BR	.12 - .28 (3 - 7)						
CD13CA-BR	CF13CA-BR	.24 - .47 (6 - 12)	PG 13 / 13.5	.80 (20.3)	.94 (24)	3.46 (88)	.39 (10)	.87 (22)
CD13CR-BR	CF13CR-BR	.20 - .35 (5 - 9)						
CD16CA-BR	CF16CA-BR	.39 - .55 (10 - 14)	PG 16	.89 (22.5)	.91 (23)	3.86 (98)	.39 (10)	.94 (24)
CD16CR-BR	CF16CR-BR	.28 - .47 (7-12)						
CD21CA-BR	CF21CA-BR	.51 - .71 (13 - 18)	PG 21	1.12 (28.4)	.94 (24)	4.37 (111)	.47 (12)	1.18 (30)
CD21CR-BR	CF21CR-BR	.35 - .63 (9 - 16)						
CD29CA-BR	-	.71 - .98 (18 - 25)	PG 29	1.47 (37.3)	1.14 (29)	-	.47 (12)	1.57 (40)
CD29CR-BR	-	.51 - .79 (13 - 20)						
CD36CA-BR	-	.87 - 1.26 (22 - 32)	PG 36	1.85 (47)	1.38 (35)	-	.59 (15)	1.97 (50)
CD36CR-BR	-	.79 - 1.02 (20 - 26)						
CD42CA-BR	-	1.26 - 1.50 (32 - 38)	PG 42	2.13 (54.1)	1.46 (37)	-	.59 (15)	2.24 (57)
CD42CR-BR	-	.98 - 1.22 (25 - 31)						
CD48CA-BR	-	1.46 - 1.73 (37 - 44)	PG 48	2.34 (59.4)	1.50 (38)	-	.59 (15)	2.52 (64)
CD48CR-BR	-	1.14 - 1.38 (29 - 35)						
CD12DA-BR	CF12DA-BR	.12 - .26 (3 - 6.5)	M12 X 1.5	.47 (12)	.75 (19)	2.17 (55)	.39 (10)	.55 (14)
CD12DR-BR	CF12DR-BR	.08 - .20 (2 - 5)	M16 X 1.5	.63 (16)	.83 (21)	2.60 (66)	.39 (10)	.67 (17) Dome .75 (19) Flex
CD16DA-BR	CF16DA-BR	.16 - .31 (4 - 8)						
CD16DR-BR	CF16DR-BR	.08 - .24 (2 - 6)	M16 X 1.5	.63 (16)	.87 (22)	3.03 (77)	.39 (10)	.79 (20)
CD17DA-BR	CF17DA-BR	.20 - .39 (5 - 10)						
CD17DR-BR	CF17DR-BR	.12 - .28 (3 - 7)	M20 X 1.5	.79 (20)	.91 (23)	3.46 (88)	.39 (10)	.87 (22)
CD20DA-BR	CF20DA-BR	.24 - .47 (6 - 12)						
CD20DR-BR	CF20DR-BR	.20 - .35 (5 - 9)	M20 X 1.5	.79 (20)	.94 (24)	3.86 (98)	.39 (10)	.94 (24)
CD22DA-BR	CF22DA-BR	.39 - .55 (10 - 14)						
CD22DR-BR	CF22DR-BR	.28 - .47 (7-12)	M25 X 1.5	.98 (25)	1.02 (25)	4.37 (111)	.47 (12)	1.18 (30)
CD25DA-BR	CF25DA-BR	.51 - .71 (13 - 18)						
CD25DR-BR	CF25DR-BR	.35 - .63 (9 - 16)	M32 X 1.5	1.26 (32)	1.22 (31)	-	.47 (12)	1.57 (40)
CD32DA-BR	-	.71 - .98 (18 - 25)						
CD32DR-BR	-	.51 - .79 (13 - 20)	M40 X 1.5	1.57 (40)	1.46 (37)	-	.59 (15)	1.97 (50)
CD40DA-BR	-	.87 - 1.26 (22 - 32)						
CD40DR-BR	-	.79 - 1.02 (20 - 26)	M50 X 1.5	1.97 (50)	1.46 (37)	-	.59 (15)	2.24 (57)
CD50DA-BR	-	1.26 - 1.50 (32 - 38)						
CD50DR-BR	-	.98 - 1.22 (25 - 31)	M63 X 1.5	2.48 (63)	1.50 (38)	-	.59 (15)	2.52 (64) / 2.68 (68)
CD63DA-BR	-	1.46 - 1.73 (37 - 44)						
CD63DR-BR	-	1.14 - 1.38 (29 - 35)						

*VDE rating applies to Metric Dome Fittings only.



Dome Fittings also available with the following approvals:



www.SealconEX.com



Optional Locking Nuts, O-Rings & Other Accessories starting on Page 29 - 40.

Nickel Plated Brass Liquid Tight Strain Relief Fittings

Mini WADI & WADI XL - PG & Metric Threads





Mini WADI Fittings solve space restriction issues. These mini components will fit into tight areas, but maintain the quality of their larger counterparts. The Standard Buna-N/TPE or the FKM O-Ring creates a reliable seal between body and housing. WADI Rating: 70 PSI, 5 BAR, IP 68.



Typical Mini WADI Applications:

- Fiber optics
- Sensors
- Cameras
- Switches
- Small appliances

Mini WADI: Smallest Cable Gland							
Part Numbers		Cable Range	Thread Type & Size	Dimensions in Inches (mm)			
-40°F to 212°F (-20°C to 100°C)	-13°F to 392°F (-25°C to 200°C)			A	B	TL	F ₁ /F
		Inches (mm)	See page 56 for thread specs	Clearance Hole	Body Length	Thread Length	Wrench Flats
				+ .01" (+.25 mm)			
CD07AW-BR*	-	.08 - .18 (2 - 4.5)	PG 7	.49 (12.5)	.56 (12.5)	.14 (3.5)	.43 (11) / .59 (15)
CD06MW-BR	CD06MW-RV	.08 - .13 (2 - 3.2)	M6 x 1	.25 (6)	.39 (10)	.24 (6)	.31 (8)
CD08MW-BR	CD08MW-RV	.12 - .20 (3 - 5)	M8 x 1.25	.33 (8)	.51 (13)	.24 (6)	.43 (11)
CD10MW-BR	-	.16 - .24 (4 - 6)	M10 x 1.5	.39 (10)	.55 (14)	.24 (6)	.47 (12)

*CD07AW-BR does not come with an O-Ring.

*CE rating applies to Mini WADI Fittings only.

Also available in Stainless Steel, Elongated & EMI.

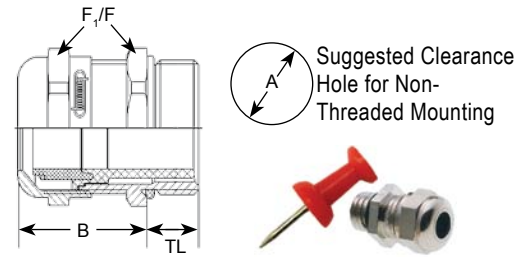

Locking Nuts: for Mini WADI			
Part Numbers	Thread Type & Size	Dimens. Inches (mm)	
		G	F
	See page 56 for thread specs	Thickness	Wrench Flats
NP-07-BR		PG 7	.11 (2.8)
NM-06-BR	M6 x 10	.10 (2.5)	.39 (10)
NM-08-BR	M8 x 1.25	.10 (2.5)	.51 (13)
NM-10-BR	M10 x 1.5	.11 (2.8)	.51 (13)

WADI XL: Largest Cable Glands							
Part Numbers		Cable Range	Thread Type & Size	Dimensions in Inches (mm)			
-40°F to 212°F (-40°C to 100°C)				A	B	TL	F ₁ /F
	Buna N	Inches (mm)	See page 56 for thread specs	Clearance Hole	Body Length	Thread Length	Wrench Flats
				+ .01" (+.25 mm)			
CX63MA-BR	1.89 - 2.17 (48-55)	M63 x 1.5	2.48 (63)	1.65 (42)	.39 (10)	2.95 (75)	3.15 (80)
CX75MA-BR	1.89 - 2.17 (48-55)	M75 x 1.5	2.95 (75)	1.65 (42)	.59 (15)	3.15 (80)	3.35 (85)
CX75MB-BR	2.09 - 2.36 (53-60)	M80 x 2	3.15 (80)	1.65 (42)	.59 (15)	3.54 (90)	3.54 (90)
CX80MA-BR	2.28 - 2.56 (58-65)	M80 x 2	3.15 (80)	1.65 (42)	.59 (15)	3.54 (90)	3.54 (90)
CX90MA-BR	2.48 - 2.76 (63-70)	M90 x 2	3.54 (90)	1.65 (42)	.59 (15)	3.94 (100)	3.94 (100)
CX90MB-BR	2.68 - 2.95 (68-75)	M90 x 2	3.54 (90)	1.65 (42)	.59 (15)	3.94 (100)	3.94 (100)
CX10MA-BR	2.87 - 3.15 (73-80)	M100 x 2	3.94 (100)	2.05 (52)	.79 (20)	4.33 (110)	4.33 (110)
CX10MB-BR	3.07 - 3.35 (78-85)	M100 x 2	3.94 (100)	2.05 (52)	.79 (20)	4.33 (110)	4.33 (110)
CX11MA-BR	3.27 - 3.54 (83-90)	M110 x 2	4.33 (110)	2.05 (52)	.79 (20)	4.72 (120)	4.72 (120)

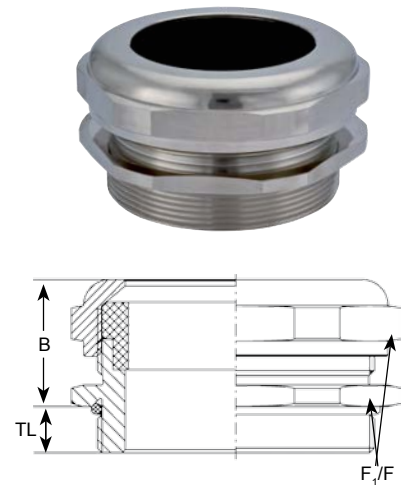

Locking Nuts: for WADI XL			
Part Numbers	Thread Type & Size	Dimens. Inches (mm)	
		G	F
	See page 56 for thread specs	Thickness	Wrench Flats
NM-63-BR		M63 x 1.5	.24 (6)
NM-75-XL	M75 x 1.5	.32 (8)	3.35 (85)
NM-80-XL	M80 x 2	.32 (8)	3.54 (90)
NM-90-XL	M90 x 2	.32 (8)	3.94 (100)
NM-10-XL	M100 x 2	.43 (11)	4.53 (115)
NM-11-XL	M110 x 2	.43 (11)	4.92 (125)

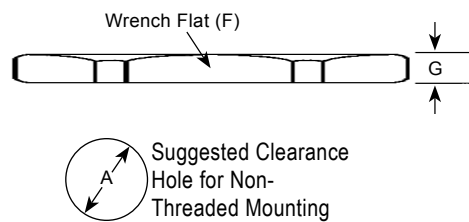



Typical XL Applications:

- Machine & Apparatus
- Automation
- Railroads
- Ship Building
- Off-shore
- Renewable Energy
- Utilities
- Nuclear Power
- Printing Machines

Silicone or FKM Inserts & O-Rings for WADI XL Fittings are available on request. For inquiries, please call our Inside Technical Sales Department (800) 456-9012 or (303) 699-1135.

Optional Locking Nuts, O-Rings & Other Accessories starting on Page 29 - 40.

Part Numbers		Cable Range	Thread Type & Size	Dimensions in Inches (mm)				
-40°F to 212°F (-40°C to 100°C)				A	H	B	TL	F
		Inches (mm)	See page 56 for thread specs	Clearance Hole	Body Height	Body Length	Thread Length	Wrench Flats
w/ Connection Threads	w/ Mounting Flange			+ .01" (+.25 mm)				
ED20MA-BR*	-	.39 - .55 (10 - 14)	M20 X 1.5	.79 (20)	1.46 (37)	2.60 (66)	.24 (6)	.98 (25)
ED20MR-BR*	-	.28 - .47 (7 - 12)						
ED13AA-BR	-	.39 - .55 (10 - 14)	PG 13 / 13.5	.80 (20.3)	1.46 (37)	2.60 (66)	.24 (6)	.98 (25)
ED13AR-BR	-	.28 - .47 (7 - 12)						
-	ED20FA-BR	.39 - .55 (10 - 14)	Flange	.79 (20)	1.14 (29)	2.60 (66)	-	.98 (25)
-	ED20FR-BR	.28 - .47 (7 - 12)						

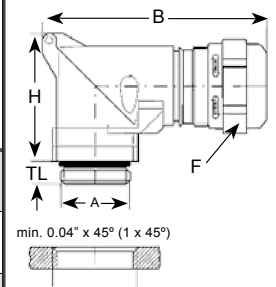

*VDE Approval only applies to Fittings with Metric Threads.

Robust - Compact - Low profile!

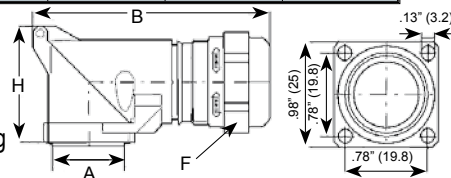

Secure your connection with these flange or threaded 90° Elbow Fittings. Saves Space and Time!

Quick & Easy Installation: Insert cable into open 90° Elbow Fitting. Close fitting and secure with screws. Tighten dome nut for a liquid tight connection. -Done!



Suggested Clearance Hole for Non-Threaded Mounting

Nickel Plated Brass Liquid Tight Strain Relief Fittings Clamp (Extra Pull-out Resistance) PG / NPT / Metric Threads

Part Numbers		Cable Range	Thread Type & Size	Dimensions in Inches (mm)				
-40°F to 212°F (-40°C to 100°C)				A	B	TL	TL	F ₁ /F ₂
		Inches (mm)	See page 56 for thread specs	Clearance Hole	Body Length	Thread Length	Thread Length	Wrench Flats
Standard	Elongated			+ .01" (+.25 mm)	Standard	Elongated		
CD07AA-MZ	CD07CA-MZ	.12 - .26 (3 - 6.5)	PG 7	.49 (12.5)	1.02 (26)	.20 (5)	.39 (10)	.55 (14)
CD09AA-MZ	CD09CA-MZ	.16 - .31 (4 - 8)	PG 9	.60 (15.2)	1.10 (28)	.24 (6)	.39 (10)	.67 (17)
CD11AA-MZ	CD11CA-MZ	.24 - .39 (6 - 10)	PG 11	.73 (18.5)	1.18 (30)	.24 (6)	.39 (10)	.79 (20)
CD13AA-MZ	CD13CA-MZ	.24 - .47 (6 - 12)	PG 13 / 13.5	.80 (20.3)	1.30 (33)	.25 (6.5)	.39 (10)	.87 (22)
CD16AA-MZ	CD16CA-MZ	.39 - .55 (10 - 14)	PG 16	.89 (22.5)	1.30(33)	.25 (6.5)	.39 (10)	.94 (24)
CD21AR-MZ	CD21CR-MZ	.51 - .71 (13 - 18)	PG 21	1.12 (28.4)	1.46 (37)	.28 (7)	.47 (12)	1.18 (30)
CD29AR-MZ	CD29CR-MZ	.71 - .98 (18 - 25)	PG 29	1.47 (37.3)	1.69 (43)	.31 (8)	.47 (12)	1.57 (40)
CD36AA-MZ	CD36CA-MZ	.87 - 1.26 (22 - 32)	PG 36	1.85 (47)	1.97 (50)	.31 (8)	.59 (15)	1.97 (50)
CD42AA-MZ	CD42CA-MZ	1.26 - 1.50 (32 - 38)	PG 42	2.13 (54.1)	2.01 (51)	.35 (9)	.59 (15)	2.24 (57)
CD42AR-MZ	CD42CR-MZ	.98 - 1.22 (25 - 31)						
CD48AA-MZ	CD48CA-MZ	1.46 - .73 (37 - 44)	PG 48	2.34 (59.4)	2.01 (51)	.39 (10)	.59 (15)	2.52 (64)
CD48AR-MZ	CD48CR-MZ	1.14 - 1.38 (29 - 35)						
CD09NA-MZ	-	.16 - .31 (4 - 8)	3/8" NPT	.68 (17.2)	1.10 (28)	.59 (15)	-	.67 (17) / .75 (19)
CD13NA-MZ	-	.28 - .47 (7 - 12)	1/2" NPT	.83 (21.1)	1.30 (33)	.51 (13)	-	.87 (22) / .94 (24)
CD21NA-MZ	-	.51 - .71 (13 - 18)	3/4" NPT	1.05 (26.7)	1.46 (37)	.51 (13)	-	1.18 (30)
CD29NA-MZ	-	.71 - .98 (18 - 25)	1" NPT	1.35 (34.3)	1.69 (43)	.75 (19)	-	1.57 (40)
CD12MA-MZ	CD12DA-MZ	.12 - .26 (3 - 6.5)	M12 X 1.5	.47 (12)	1.02 (26)	.26 (6.5)	.39 (10)	.55 (14)
CD16MA-MZ	CD16DA-MZ	.16 - .31 (4 - 8)	M16 X 1.5	.63 (16)	1.10 (28)	.24 (6)	.39 (10)	.67 (17) / .75 (19)
CD17MA-MZ	CD17DA-MZ	.24 - .39 (6 - 10)	M16 X 1.5	.63 (16)	1.18 (30)	.24 (6)	.39 (10)	.79 (20)
CD20MA-MZ	CD20DA-MZ	.24 - .47 (6 - 12)	M20 X 1.5	.79 (20)	1.30 (33)	.24 (6)	.39 (10)	.87 (22)
CD22MA-MZ	CD22DA-MZ	.39 - .55 (10 - 14)	M20 X 1.5	.79 (20)	1.30(33)	.24 (6)	.39 (10)	.94 (24)
CD25MA-MZ	CD25DA-MZ	.51 - .71 (13 - 18)	M25 X 1.5	.98 (25)	1.46 (37)	.28 (7)	.47 (12)	1.18 (30)
CD32MA-MZ	CD32DA-MZ	.71 - .98 (18 - 25)	M32 X 1.5	1.26 (32)	1.69 (43)	.31 (8)	.47 (12)	1.57 (40)
CD40MA-MZ	CD40DA-MZ	.87 - 1.26 (22 - 32)	M40 X 1.5	1.57 (40)	1.97 (50)	.31 (8)	.59 (15)	1.97 (50)
CD50MA-MZ	CD50DA-MZ	1.26 - 1.50 (32 - 38)	M50 X 1.5	1.97 (50)	2.01 (51)	.35 (9)	.59 (15)	2.24 (57)
CD50MR-MZ	CD50DR-MZ	.98 - 1.22 (25 - 31)						
CD63MA-MZ	CD63DA-MZ	1.46 - 1.73 (37 - 44)	M63 X 1.5	2.48 (63)	2.01 (51)	.39 (10)	.59 (15)	2.52 (64) / 2.68 (68)
CD63MR-MZ	CD63DR-MZ	1.14 - 1.38 (29 - 35)						



Dome Fittings also available with the following approvals:

ATEX
www.SealconEX.com

High Performance Strain Relief Clamp Fittings Provides Extra Pull-out Resistance.

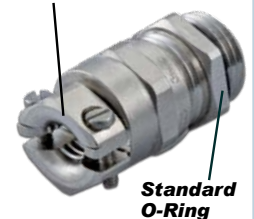

Standard O-Ring



Suggested Clearance Hole for Non-Threaded Mounting

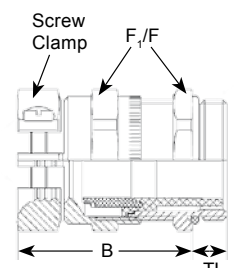

*VDE Approval only applies to Standard Fittings with Metric Threads.

Nickel Plated Brass Liquid Tight Strain Relief Fittings

EMI / RFI Proof - Product Features



Nickel Plated Brass



EMI (Electromagnetic Interference) / **RFI** (Radio Frequency Interference) is an unwanted disturbance that affects an electrical circuit due to either electromagnetic conduction or electromagnetic radiation emitted from an external source. The disturbance may interrupt, obstruct, or otherwise limit the effective performance of the circuit.

These Liquid Tight EMI / RFI - Proof Grounded Strain Relief Fittings made of Nickel Plated Brass are the perfect answer to stringent requirements for reliable grounding and protection from electromagnetic interference.

Two styles are available: Standard and Feed-Through.

The Standard version has an integral O-Ring, which presses the braiding against the inside wall of the body but can only be used with BRAIDED shield.

Standard (-BE)

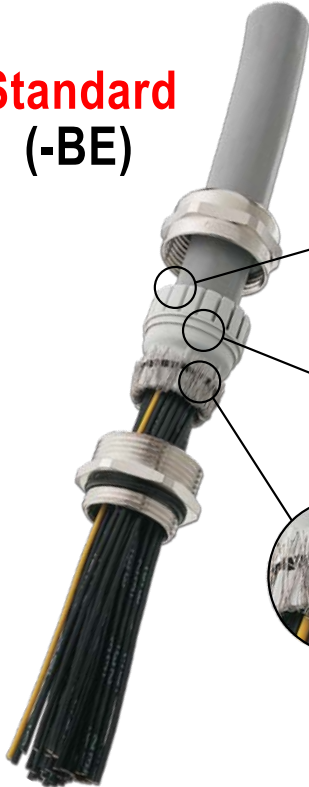

Overlapping clamping splines apply a concentric force, thereby preventing the form seal from being pulled out of the fitting. This ensures pull-out protection without damage to the cable.



The patented internal sealing edge results in a superior seal between the splined Nylon clamping insert and Nickel Plated Brass body.



Patented 360° grounding due to the internal O-Ring, which ensures perfect contact between braided shield of cable and fitting.

Feed-Through works well with FOIL or BRAIDED shield and provides reliable grounding by means of metalized spring fingers.

Feed-Through (-FE)

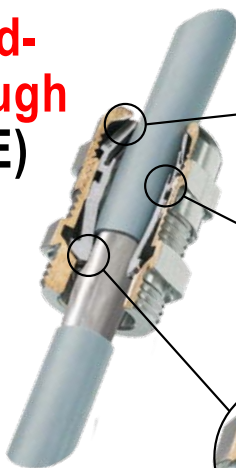

Overlapping clamping splines apply a concentric force, thereby preventing the form seal from being pulled out of the fitting. This ensures pull-out protection without damage to the cable.



Our Metal-coated Nylon splines provides the highest electrical conductivity ratings in the industry.



Flexible contact points allow contact with variable braid and foil cable diameters and adds additional strain relief to a solution.



Dome Fittings also available with the following approvals:



www.SealconEX.com

EMI/RFI Proof Strain Relief Fittings Applications:

- Telecommunication
- Measuring, control and feedback systems
- Control panels
- Traffic, etc.

Also used in all areas where in addition to a reliable liquid tight seal, high pull-out resistance and anti-rotation provisions, a dependable contact with the cable shield is required.

- Halogen and Phosphorous-Free / Non-Toxic
- Fire Protection Class V0 According to UL 94
- Liquid Tight per Type NEMA 4x & 6 to 150 PSIG (IP 68 to 10 bar)
- Quick Assembly and Reliable Grounding of Braid or Foil Shielded Cables









Dome Fittings also available with the following approvals:



To ensure a good ground connection between the Cord Grip and a Metal Enclosure, we strongly recommend the use of EMI/RFI Locking Nuts (Page 30) for non-threaded mounting.

These Locking Nuts have cutting edges which will slice through paint coatings on a metal enclosure to ensure grounding (Page 30). Also, these Locking Nuts are suitable for vibrating applications.



Assembly Instructions	
<p>Standard (-BE)</p>  <p>Step 1</p> <ul style="list-style-type: none"> • Strip cable • Expose braided shield  <p>Step 2</p> <ul style="list-style-type: none"> • Feed cable through dome nut & clamping insert • Fold braided shield back over O-Ring on clamping insert • Make sure that braided shield overlaps the O-ring by 3/32" (2 mm) only  <p>Step 3</p> <ul style="list-style-type: none"> • Push clamping insert into body • Tighten dome nut • Finished 	<p>Feed-Through (-FE)</p>  <p>Option 1 - Partial Jacket Stripping:</p> <ul style="list-style-type: none"> • Expose shield approximately 7/16" (10 mm) • Insert cable into fitting until the foil or braid reaches the contact position • Tighten the dome nut • Finished  <p>Option 2 - Total Jacket Removed:</p> <ul style="list-style-type: none"> • Remove cable jacket to expose the braid or foil • Insert cable into fitting until the braid reaches the contact point • Tighten the dome nut • Finished  <p>Option 3 - Fold Shield over Jacket:</p> <ul style="list-style-type: none"> • Strip cable jacket & braiding to different lengths • For smaller cable diameters fold the braided shield back over the cable jacket • Insert cable into fitting until the braid reaches the contact point • Tighten the dome nut • Finished

Questions or concerns? - Please call our well-trained Inside Technical Sales Department (800) 456-9012 or (303) 699-1135.

Nickel Plated Brass Liquid Tight Strain Relief Fittings

EMI / RFI Proof - PG / NPT / Metric & Elongated



Nickel Plated Brass

EMI/RFI Ground Proof: Standard Version (-BE)

Part Numbers				Cable Range	Thread Type & Size	Dimensions in Inches (mm)					
-40°F to 212°F (-40°C to 100°C)						A	B	C	TL	TL	F ₁ /F
Dome Standard	Flex Standard	Dome Elongated	Flex Elongated	Inches (mm)	See Page 56 for thread specs	Clearance Hole +.01" (+.25 mm)	Body Length (Dome)	Body Length (Flex)	Thread Length Standard	Thread Length Elongated	Wrench Flats
CD07AA-BE	CF07AA-BE	CD07CA-BE	CF07CA-BE	.12 - .26 (3 - 6.5)	PG 7 / 1/4" NPT	.49 (12.5)	.75 (19)	2.17 (55)	.20 (5)	.39 (10)	.55 (14)
CD07AR-BE	CF07AR-BE	CD07CR-BE	CF07CR-BE	.08 - .20 (2 - 5)							
CD09AA-BE	CF09AA-BE	CD09CA-BE	CF09CA-BE	.16 - .31 (4 - 8)	PG 9	.60 (15.2)	.83 (21)	2.60 (66)	.24 (6)	.39 (10)	.67 (17)
CD09AR-BE	CF09AR-BE	CD09CR-BE	CF09CR-BE	.08 - .24 (2 - 6)							
CD11AA-BE	CF11AA-BE	CD11CA-BE	CF11CA-BE	.20 - .39 (5 - 10)	PG 11	.73 (18.5)	.87 (22)	3.03 (77)	.24 (6)	.39 (10)	.79 (20)
CD11AR-BE	CF11AR-BE	CD11CR-BE	CF11CR-BE	.12 - .28 (3 - 7)							
CD13AA-BE	CF13AA-BE	CD13CA-BE	CF13CA-BE	.24 - .47 (6 - 12)	PG 13 / 13.5	.80 (20.3)	.94 (24)	3.46 (88)	.26 (6.5)	.39 (10)	.87 (22)
CD13AR-BE	CF13AR-BE	CD13CR-BE	CF13CR-BE	.20 - .35 (5 - 9)							
CD16AA-BE	CF16AA-BE	CD16CA-BE	CF16CA-BE	.39 - .55 (10 - 14)	PG 16	.89 (22.5)	.91 (23)	3.86 (98)	.26 (6.5)	.39 (10)	.94 (24)
CD16AR-BE	CF16AR-BE	CD16CR-BE	CF16CR-BE	.28 - .47 (7 - 12)							
CD21AA-BE	CF21AA-BE	CD21CA-BE	CF21CA-BE	.51 - .71 (13 - 18)	PG 21	1.12 (28.4)	.94 (24)	4.37 (111)	.28 (7)	.47 (12)	1.18 (30)
CD21AR-BE	CF21AR-BE	CD21CR-BE	CF21CR-BE	.35 - .63 (9 - 16)							
CD29AA-BE	-	CD29CA-BE	-	.71 - .98 (18 - 25)	PG 29	1.47 (37.3)	1.14 (29)	-	.31 (8)	.47 (12)	1.57 (40)
CD29AR-BE	-	CD29CR-BE	-	.51 - .79 (13 - 20)							
CD36AA-BE	-	CD36CA-BE	-	.87 - 1.26 (22 - 32)	PG 36	1.85 (47)	1.38 (35)	-	.31 (8)	.59 (15)	1.97 (50)
CD36AR-BE	-	CD36CR-BE	-	.79 - 1.02 (20 - 26)							
CD42AA-BE	-	CD42CA-BE	-	1.26 - 1.50 (32 - 38)	PG 42	2.13 (54.1)	1.46 (37)	-	.35 (9)	.59 (15)	2.24 (57)
CD42AR-BE	-	CD42CR-BE	-	.98 - 1.22 (25 - 31)							
CD48AA-BE	-	CD48CA-BE	-	1.46 - .73 (37 - 44)	PG 48	2.34 (59.4)	1.50 (38)	-	.39 (10)	.59 (15)	2.52 (64)
CD48AR-BE	-	CD48CR-BE	-	1.14 - 1.38 (29 - 35)							
CD09NA-BE	CF09NA-BE	-	-	.16 - .31 (4 - 8)	3/8" NPT	.68 (17.2)	.83 (21)	2.60 (66)	.59 (15)	-	.67 (17) / .75 (19)
CD09NR-BE	CF09NR-BE	-	-	.08 - .20 (2 - 6)							
CD13NA-BE	CF13NA-BE	-	-	.24 - .47 (6 - 12)	1/2" NPT	.83 (21.1)	.94 (24)	3.46 (88)	.51 (13)	-	.87 (22) / .94 (24)
CD13NR-BE	CF13NR-BE	-	-	.20 - .35 (5 - 9)							
CD21NA-BE	CF21NA-BE	-	-	.51 - .71 (13 - 18)	3/4" NPT	1.05 (26.7)	.98 (25)	4.37 (111)	.51 (13)	-	1.18 (30)
CD21NR-BE	CF21NR-BE	-	-	.35 - .63 (9 - 16)							
CD12MA-BE	CF12MA-BE	CD12DA-BE	CF12DA-BE	.12 - .26 (3 - 6.5)	M12 X 1.5	.47 (12)	.75 (19)	2.17 (55)	.26 (6.5)	.39 (10)	.55 (14)
CD12MR-BE	CF12MR-BE	CD12DR-BE	CF12DR-BE	.08 - .20 (2 - 5)							
CD16MA-BE	CF16MA-BE	CD16DA-BE	CF16DA-BE	.20 - .39 (5 - 10)	M16 X 1.5	.63 (16)	.87 (22)	3.03 (77)	.24 (6)	.39 (10)	.79 (20)
CD16MR-BE	CF16MR-BE	CD16DR-BE	CF16DR-BE	.12 - .28 (3 - 7)							
CD20MA-BE	CF20MA-BE	CD20DA-BE	CF20DA-BE	.39 - .55 (10 - 14)	M20 X 1.5	.79 (20)	.94 (24)	3.86 (98)	.24 (6)	.39 (10)	.94 (24)
CD20MR-BE	CF20MR-BE	CD20DR-BE	CF20DR-BE	.28 - .47 (7 - 12)							
CD25MA-BE	CF25MA-BE	CD25DA-BE	CF25DA-BE	.51 - .71 (13 - 18)	M25 X 1.5	.98 (25)	1.02 (25)	4.37 (111)	.28 (7)	.47 (12)	1.18 (30)
CD25MR-BE	CF25MR-BE	CD25DR-BE	CF25DR-BE	.35 - .63 (9 - 16)							
CD32MA-BE	-	CD32DA-BE	-	.71 - .98 (18 - 25)	M32 X 1.5	1.26 (32)	1.22 (31)	-	.31 (8)	.47 (12)	1.57 (40)
CD32MR-BE	-	CD32DR-BE	-	.51 - .79 (13 - 20)							
CD40MA-BE	-	CD40DA-BE	-	.87 - 1.26 (22 - 32)	M40 X 1.5	1.57 (40)	1.46 (37)	-	.31 (8)	.59 (15)	1.97 (50)
CD40MR-BE	-	CD40DR-BE	-	.79 - 1.02 (20 - 26)							
CD50MA-BE	-	Available	-	1.26 - 1.50 (32 - 38)	M50 X 1.5	1.97 (50)	1.46 (37)	-	.35 (9)	.59 (15)	2.24 (57)
CD50MR-BE	-	Available	-	.98 - 1.22 (25 - 31)							
CD63MA-BE	-	Available	-	1.46 - 1.73 (37 - 44)	M63 X 1.5	2.48 (63)	1.50 (38)	-	.39 (10)	.59 (15)	2.52 (64) / 2.68 (68)
CD63MR-BE	-	Available	-	1.14 - 1.38 (29 - 35)							

*UL, UR & CSA Approval applies to Dome Fittings.

*VDE Approval only applies to Dome Fittings with Metric Threads.



EMI/RFI Fittings are also available with High Performance Clamp or in Stainless Steel. For inquiries - please call our Inside Technical Sales Department (800) 456-9012 or (303) 699-1135.



Dome Fittings also available with the following approvals:



www.SealconEX.com



EMI/RFI Ground Proof: Feed-Through Version (-FE)

Part Numbers		Cable Range Inches (mm)	Thread Type & Size See page 56 for thread specs	Dimensions in Inches (mm)				
-40°F to 212°F (-40°C to 100°C)				A Clearance Hole +.01" (+.25 mm)	B Body Length	TL Thread Length	TL Thread Length	F ₁ /F Wrench Flats
								
Standard	Elongated					Standard	Elongated	
CD07AA-FE	-	.12 - .26 (3 - 6.5)	PG 7 / 1/4" NPT	.49 (12.5)	.94 (24)	.20 (5)	-	.55 (14)
CD09AA-FE	-	.16 - .31 (4 - 8)	PG 9	.60 (15.2)	1.10 (28)	.24 (6)	-	.67 (17)
CD11AA-FE	-	.20 - .39 (5 - 10)	PG 11	.73 (18.5)	1.14 (29)	.24 (6)	-	.79 (20)
CD13AA-FE	-	.24 - .47 (6 - 12)	PG 13 / 13.5	.80 (20.3)	1.22 (31)	.26 (6.5)	-	.87 (22)
CD16AA-FE	-	.39 - .55 (10 - 14)	PG 16	.88 (22.5)	1.26(32)	.26 (6.5)	-	.94 (24)
CD21AA-FE	-	.51 - .71 (13 - 18)	PG 21	1.12 (28.4)	1.50 (38)	.28 (7)	-	1.18 (30)
CD29AA-FE	-	.71 - .98 (18 - 25)	PG 29	1.47 (37.3)	1.69 (43)	.31 (8)	-	1.57 (40)
CD36AA-FE	-	.94 - 1.26 (24 - 32)	PG 36	1.85 (47)	1.89 (48)	.31 (8)	-	1.97 (50)
CD42AA-FE	-	1.26 - 1.50 (32 - 38)	PG 42	2.13 (54.1)	1.77 (45)	.35 (9)	-	2.24 (57)
CD48AA-FE	-	1.46 - 1.73 (37 - 44)	PG 48	2.34 (59.4)	1.81 (46)	.39 (10)	-	2.52 (64)
CD09NA-FE	-	.16 - .31 (4 - 8)	3/8" NPT	.68 (17.2)	1.14 (29)	.59 (15)	-	.67 (17) / .75 (19)
CD13NA-FE	-	.24 - .47 (6 - 12)	1/2" NPT	.83 (21.1)	1.28 (32.5)	.51 (13)	-	.87 (22) / .94 (24)
CD21NA-FE	-	.51 - .71 (13 - 18)	3/4" NPT	1.05 (26.7)	1.54 (39)	.51 (13)	-	1.18 (30)
CD12MA-FE	CD12DA-FE	.12 - .26 (3 - 6.5)	M12 X 1.5	.47 (12)	.98 (25)	.26 (6.5)	.39 (10)	.55 (14)
CD16MA-FE	CD16DA-FE	.20 - .39 (5 - 10)	M16 X 1.5	.63 (16)	1.26 (32)	.24 (6)	.39 (10)	.79 (20)
CD16MR-FE	CD16DR-FE	.16 - .31 (4 - 8)	M16 X 1.5	.63 (16)	1.14 (29)	.24 (6)	.39 (10)	.67 (17) / .75 (19)
CD20MA-FE	CD20DA-FE	.39 - .55 (10 - 14)	M20 X 1.5	.79 (20)	1.30 (33)	.24 (6)	.39 (10)	.94 (24)
CD20MR-FE	CD20DR-FE	.24 - .47 (6 - 12)	M20 X 1.5	.79 (20)	1.28 (32.5)	.24 (6)	.39 (10)	.87 (22)
CD25MA-FE	CD25DA-FE	.51 - .71 (13 - 18)	M25 X 1.5	.98 (25)	1.54 (39)	.28 (7)	.47 (12)	1.18 (30)
CD32MA-FE	CD32DA-FE	.71 - .98 (18 - 25)	M32 X 1.5	1.26 (32)	1.77 (45)	.31 (8)	.47 (12)	1.57 (40)
CD40MA-FE	CD40DA-FE	.94 - 1.26 (24 - 32)	M40 X 1.5	1.57 (40)	2.01 (51)	.31 (8)	.59 (15)	1.97 (50)
CD50MA-FE	CD50DA-FE	1.26 - 1.50 (32 - 38)	M50 X 1.5	1.97 (50)	2.24 (57.5)	.35 (9)	.59 (15)	2.24 (57)
CD63MA-FE	CD63DA-FE	1.46 - 1.73 (37 - 44)	M63 X 1.5	2.48 (63)	2.05 (52)	.39 (10)	.59 (15)	2.52 (64) / 2.68 (68)

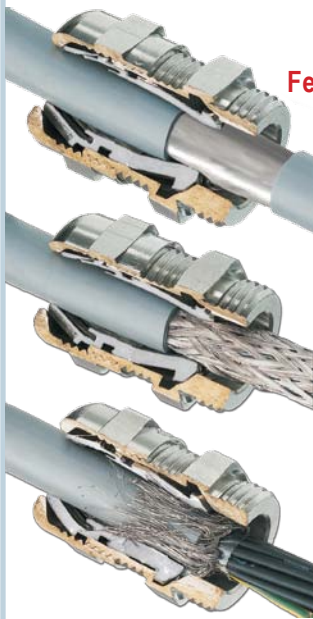

Feed-Through (-FE)

Feed-Through Products are Quick, Reliable & Labor Saving!

Partial Jacket Stripping

Total Jacket Removal

Fold Shield Over Jacket



Metalized Finger for additional EMI Shielding.

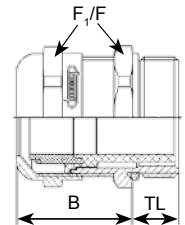

Suggested Clearance Hole for Non-Threaded Mounting

Dome Fittings also available with the following approvals:



www.SealconEX.com



Optional Locking Nuts, O-Rings & Other Accessories starting on Page 29 - 40.



Use our recommended **EMI Locking Nuts with cutting edges** which will cut through paint to ensure proper grounding (see page 30). Also, these Locking Nuts are suitable for vibrating applications.

Nickel Plated Brass Liquid Tight Strain Relief Fittings

Multi-Hole - PG Threads



Nickel Plated Brass

Part Numbers		Thread Type & Size	Dimensions in Inches (mm)			Part Numbers of Inserts Only
-40°F to 212°F (-40°C to 100°C)			No. of Holes	Diameter of Holes		
Dome	Flex**	See page 56 for thread specs		mm	Inches	
CD07AP-BR	CF07AP-BR		PG 7 / 1/4" NPT	Solid Insert		
CD09A1-BR	CF09A1-BR	PG 9	4	1.4	.06	1.089.0900.19
CD09A2-BR	CF09A2-BR		2	3.0	.12	1.089.0901.19
CD09A3-BR	CF09A3-BR		5	1.6	.06	1.089.0902.19
CD09A4-BR	CF09A4-BR		2	1.7	.07	1.089.0903.19
CD09A5-BR	CF09A5-BR		10	1.4	.06	1.089.0904.19
CD09A6-BR	CF09A6-BR		6	1.4	.06	1.089.0905.19
CD09A7-BR	CF09A7-BR		3	1.7	.07	1.089.0906.19
CD09A8-BR	CF09A8-BR		4	1.7	.07	1.089.0907.19
CD09A9-BR	CF09A9-BR		4	2.3	.09	1.089.0908.19
CD09AP-BR	CF09AP-BR		Solid Insert		1.089.0999.19	
CD11A1-BR	CF11A1-BR	PG 11	2	3.0	.12	1.089.1100.19
CD11A2-BR	CF11A2-BR		3	3.0	.12	1.089.1101.19
CD11A3-BR	CF11A3-BR		2	4.0	.16	1.089.1102.19
CD11A4-BR	CF11A4-BR		3	1.5	.06	1.089.1103.19
CD11A5-BR	CF11A5-BR		4	2.8	.11	1.089.1104.19
CD11AP-BR	CF11AP-BR	Solid Insert		1.089.1199.19		
CD13A1-BR	CF13A1-BR	PG 13 / 13.5	3	2.0	.08	1.089.1300.19
CD13A2-BR	CF13A2-BR		6	3.0	.12	1.089.1301.19
CD13A3-BR	CF13A3-BR		3	4.0	.16	1.089.1302.19
CD13A4-BR	CF13A4-BR		2	5.0	.20	1.089.1303.19
CD13A5-BR	CF13A5-BR		3	3.0	.12	1.089.1304.19
CD13A6-BR	CF13A6-BR		2	5.2	.20	1.089.1305.19
CD13A7-BR	CF13A7-BR		2	3.8	.15	1.089.1306.19
CD13A8-BR	CF13A8-BR		2	4.2	.17	1.089.1307.19
CD13A9-BR	CF13A9-BR		2	2.5	.10	1.089.1308.19
CD13AP-BR	CF13AP-BR		Solid Insert		1.089.1399.19	
CD16A1-BR	CF16A1-BR	PG 16	3	3.0	.12	1.089.1600.19
CD16A2-BR	CF16A2-BR		3	4.0	.16	1.089.1601.19
CD16A3-BR	CF16A3-BR		4	4.0	.16	1.089.1602.19
CD16A4-BR	CF16A4-BR		5	4.0	.16	1.089.1603.19
CD16A5-BR	CF16A5-BR		6	4.0	.16	1.089.1604.19
CD16A6-BR	CF16A6-BR		2	6.0	.24	1.089.1605.19
CD16A7-BR	CF16A7-BR		3	5.6	.22	1.089.1606.19
CD16A8-BR	CF16A8-BR		6	3.0	.12	1.089.1607.19
CD16A9-BR	CF16A9-BR		*4	3.0	.12	*1.089.1610.19
CD16A0-BR	CF16A0-BR		6	3.8	.15	1.089.1609.19
CD16AP-BR	CF16AP-BR	Solid Insert		1.089.1699.19		

*This Insert has slotted holes.

**Flex Fittings are not a standard item, assembly required.

*CSA and CE Approvals only applies to Dome Fittings.

Part Numbers		Thread Type & Size	Dimensions in Inches (mm)			Part Numbers of Inserts Only
-40°F to 212°F (-40°C to 100°C)			No. of Holes	Diameter of Holes		
Dome	Flex**	See page 56 for thread specs		mm	Inches	
CD21A1-BR	CF21A1-BR		PG 21	4	6.0	
CD21A2-BR	CF21A2-BR	3		7.0	.28	1.089.2101.19
CD21A3-BR	CF21A3-BR	2		8.0	.31	1.089.2102.19
CD21A4-BR	CF21A4-BR	4		5.0	.20	1.089.2103.19
CD21A5-BR	CF21A5-BR	1		8.0	.31	1.089.2104.19
CD21A6-BR	CF21A6-BR	4		5.2	.20	1.089.2105.19
CD21A7-BR	CF21A7-BR	3		5.2	.20	1.089.2106.19
CD21A8-BR	CF21A8-BR	4/1		5.2 / 3.7	.20 / .15	1.089.2107.19
CD21A9-BR	CF21A9-BR	2		7.4	.29	1.089.2108.19
CD21AP-BR	CF21AP-BR	Solid Insert		1.089.2199.19		
CD29A1-BR	-	PG 29	6	6.5	.26	1.089.2900.19
CD29A2-BR	-		4	9.0	.35	1.089.2901.19
CD29A3-BR	-		4	9.5	.37	1.089.2902.19
CD29A9-BR	-		2	11.0	.43	1.089.2908.19
CD29AP-BR	-	Solid Insert		1.089.2999.19		
CD36A1-BR	-	PG 36	5	9.0	.35	1.089.3600.19
CD36A2-BR	-		7	9.0	.35	1.089.3601.19
CD36A3-BR	-		6	8.0	.31	1.089.3602.19
CD36A4-BR	-		2	15.0	.59	1.089.3603.19
CD36AP-BR	-		Solid Insert		1.089.3699.19	
CD42A1-BR	-	PG 42	3	14.0	.55	1.089.4203.19
CD42AP-BR	-		Solid Insert		1.089.4299.19	
CD48A1-BR	-	PG 48	8	10.0	.39	1.089.4800.19
CD48A2-BR	-		6	12.0	.47	1.089.4801.19
CD48A3-BR	-		3	18.0	.71	1.089.4802.19
CD48AP-BR	-		Solid Insert		1.089.4899.19	

RJ45 Solution

Part Numbers		Thread Type & Size	Dimensions in Inches (mm)		Part Numbers of Inserts Only
-40°F to 212°F (-40°C to 100°C)			Cable Diameter		
		See page 56 for thread specs	mm	Inches	
CD16AK-BR	PG 16		5.7	.23	
CD16AJ-BR	PG 16	6.9	.27	1.089.16C-07	

*RJ45 Solution has no approval ratings. Reference Diagram on page 24.

For Strain Relief Fitting specifications and dimensions refer to page 14.

For Material Specifications and Approval Information refer to page 52.



Optional Locking Nuts, O-Rings & Other Accessories starting on Page 29 - 40.

Dome Fittings also available with the following approvals:



ATEX

www.SealconEX.com

Solid Plug can be customized!

Multi-Hole Inserts are available in Silicone and FKM upon request.

"BP" (Billet Plugs) available.





Nickel Plated Brass

Part Numbers		Thread Type & Size	Dimensions in Inches (mm)			
-40°F to 212°F (-40°C to 100°C)			No. of Holes	Diameter of Holes		Part Numbers of Inserts Only
Dome	Flex**	mm		Inches		
CD07AP-BR	CD07AP-BR	PG 7 / 1/4" NPT	Solid Insert		1.089.0799.19	
CD09N1-BR	CF09N1-BR	3/8" NPT	4	1.4	.06	1.089.0900.19
CD09N2-BR	CF09N2-BR		2	3.0	.12	1.089.0901.19
CD09N3-BR	CF09N3-BR		5	1.6	.06	1.089.0902.19
CD09N4-BR	CF09N4-BR		2	1.7	.07	1.089.0903.19
CD09N5-BR	CF09N5-BR		10	1.4	.06	1.089.0904.19
CD09N6-BR	CF09N6-BR		6	1.4	.06	1.089.0905.19
CD09N7-BR	CF09N7-BR		3	1.7	.07	1.089.0906.19
CD09N8-BR	CF09N8-BR		4	1.7	.07	1.089.0907.19
CD09N9-BR	CF09N9-BR		4	2.3	.09	1.089.0908.19
CD09NP-BR	CF09NP-BR		Solid Insert		1.089.0999.19	
CD13N1-BR	CF13N1-BR	1/2" NPT	3	2.0	.08	1.089.1300.19
CD13N2-BR	CF13N2-BR		6	3.0	.12	1.089.1301.19
CD13N3-BR	CF13N3-BR		3	4.0	.16	1.089.1302.19
CD13N4-BR	CF13N4-BR		2	5.0	.20	1.089.1303.19
CD13N5-BR	CF13N5-BR		3	3.0	.12	1.089.1304.19
CD13N6-BR	CF13N6-BR		2	5.2	.20	1.089.1305.19
CD13N7-BR	CF13N7-BR		2	3.8	.15	1.089.1306.19
CD13N8-BR	CF13N8-BR		2	4.2	.17	1.089.1307.19
CD13N9-BR	CF13N9-BR		2	2.5	.10	1.089.1308.19
CD13NP-BR	CF13NP-BR		Solid Insert		1.089.1399.19	
CD16N1-BR	CF16N1-BR	1/2" NPT (Enlarged)	3	3.0	.12	1.089.1600.19
CD16N2-BR	CF16N2-BR		3	4.0	.16	1.089.1601.19
CD16N3-BR	CF16N3-BR		4	4.0	.16	1.089.1602.19
CD16N4-BR	CF16N4-BR		5	4.0	.16	1.089.1603.19
CD16N5-BR	CF16N5-BR		6	4.0	.16	1.089.1604.19
CD16N6-BR	CF16N6-BR		2	6.0	.24	1.089.1605.19
CD16N7-BR	CF16N7-BR		3	5.6	.22	1.089.1606.19
CD16N8-BR	CF16N8-BR		6	3.0	.12	1.089.1607.19
CD16N9-BR	CF16N9-BR		*4	3.0	.12	*1.089.1610.19
CD16N0-BR	CF16N0-BR		6	3.8	.15	1.089.1609.19
CD16NP-BR	CF16NP-BR	Solid Insert		1.089.1699.19		

*This Insert has slotted holes.

**Flex Fittings are not a standard item, assembly required.

*CSA and CE Approvals only applies to Dome Fittings.

For Strain Relief Fitting specifications and dimensions refer to page 14.
For Material Specifications and Approval Information refer to page 52.

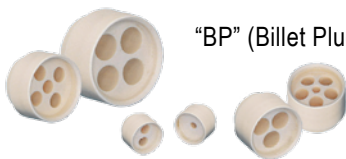

"BP" (Billet Plugs) available upon request.

Dome Fittings also available with the following approvals:



www.SealconEX.com



Optional Locking Nuts, O-Rings & Other Accessories starting on Page 29 - 40.

Part Numbers		Thread Type & Size	Dimensions in Inches (mm)			
-40°F to 212°F (-40°C to 100°C)			No. of Holes	Diameter of Holes		Part Numbers of Inserts Only
Dome	Flex**	mm		Inches		
CD21N1-BR	CF21N1-BR	3/4" NPT	4	6.0	.24	1.089.2100.19
CD21N2-BR	CF21N2-BR		3	7.0	.28	1.089.2101.19
CD21N3-BR	CF21N3-BR		2	8.0	.31	1.089.2102.19
CD21N4-BR	CF21N4-BR		4	5.0	.20	1.089.2103.19
CD21N5-BR	CF21N5-BR		1	8.0	.31	1.089.2104.19
CD21N6-BR	CF21N6-BR		4	5.2	.20	1.089.2105.19
CD21N7-BR	CF21N7-BR		3	5.2	.20	1.089.2106.19
CD21N8-BR	CF21N8-BR		4/1	5.2/3.7	.20/.15	1.089.2107.19
CD21N9-BR	CF21N9-BR		2	7.4	.29	1.089.2108.19
CD21NP-BR	CF21NP-BR		Solid Insert		1.089.2199.19	
CD29N1-BR	-	1" NPT	6	6.5	.26	1.089.2900.19
CD29N2-BR	-		4	9.0	.35	1.089.2901.19
CD29N3-BR	-		4	9.5	.37	1.089.2902.19
CD29N9-BR	-		2	11.0	.43	1.089.2908.19
CD29NP-BR	-		Solid Insert		1.089.2999.19	

RJ45 Solution					
Part Numbers		Thread Type & Size	Dimensions in Inches (mm)		
-40°F to 212°F (-40°C to 100°C)			Cable Diameter		Part Numbers of Inserts Only
Dome	Flex**	mm	Inches		
CD16NK-BR	1/2" NPT	5.7	.23	1.089.16C-06	
CD16NJ-BR	1/2" NPT	6.9	.27	1.089.16C-07	

*RJ45 Solution has no approval ratings. Reference Diagram on page 24.

Custom Solutions!

- Any custom hole configuration is available for a minimum order of 1,000 pieces.
- No charge for standard delivery time.
- **For small quantities we suggest drilling or machining the inserts yourself, following these guidelines:**
 - We suggest freezing the solid insert before drilling.
 - Drill holes with insert installed in Strain Relief Fitting as a fixture.
 - Drill holes by using a standard high-speed steel drill bit of the proper size at approx. 2500 RPM.
 - Keep a minimum distance of 1 mm (.04 in) between holes.
 - The outside holes can be located right against the lip of the strain relief body, as sufficient insert material remains between the hole and the body wall due to the design of the cord grip.

Important:

Design Parameters: Cable diameter should not be less than 80% of hole diameter and the difference between hole and cable diameter should never exceed .04" (1 mm). The Multi Cable fittings will meet Type NEMA 4x = IP 65 if the design parameters are complied with.

To verify a submersible Type NEMA 6= IP 68 application, the final assembly of cables and fittings must be tested by the customer or submitted at the customer's expense to an independent test lab.

Nickel Plated Brass Liquid Tight Strain Relief Fitting Multi-Hole - Metric Threads



Nickel Plated Brass

Part Numbers		Thread Type & Size	Dimensions in Inches (mm)			
-40°F to 212°F (-40°C to 100°C)			No. of Holes	Diameter of Holes		Part Numbers of Inserts Only
Dome	Flex**	mm		Inches		
CD12MP-BR	CF12MP-BR	M12 X 1.5	Solid Insert		1.089.0799.19	
CD16M1-BR	CF16M1-BR	M16 X 1.5	4	1.4	.06	1.089.0900.19
CD16M2-BR	CF16M2-BR		2	3.0	.12	1.089.0901.19
CD16M3-BR	CF16M3-BR		5	1.6	.06	1.089.0902.19
CD16M4-BR	CF16M4-BR		2	1.7	.07	1.089.0903.19
CD16M5-BR	CF16M5-BR		10	1.4	.06	1.089.0904.19
CD16M6-BR	CF16M6-BR		6	1.4	.06	1.089.0905.19
CD16M7-BR	CF16M7-BR		3	1.7	.07	1.089.0906.19
CD16M8-BR	CF16M8-BR		4	1.7	.07	1.089.0907.19
CD16M9-BR	CF16M9-BR		4	2.3	.09	1.089.0908.19
CD16MP-BR	CF16MP-BR		Solid Insert		1.089.0999.19	
CD17M1-BR	CF17M1-BR	M16 X 1.5 (Enlarged)	2	3.0	.12	1.089.1100.19
CD17M2-BR	CF17M2-BR		3	3.0	.12	1.089.1101.19
CD17M3-BR	CF17M3-BR		2	4.0	.16	1.089.1102.19
CD17M4-BR	CF17M4-BR		3	1.5	.06	1.089.1103.19
CD17M5-BR	CF17M5-BR		4	2.8	.11	1.089.1104.19
CD17MP-BR	CF17MP-BR	Solid Insert		1.089.1199.19		
CD20M1-BR	CF20M1-BR	M20 X 1.5	3	2.0	.08	1.089.1300.19
CD20M2-BR	CF20M2-BR		6	3.0	.12	1.089.1301.19
CD20M3-BR	CF20M3-BR		3	4.0	.16	1.089.1302.19
CD20M4-BR	CF20M4-BR		2	5.0	.20	1.089.1303.19
CD20M5-BR	CF20M5-BR		3	3.0	.12	1.089.1304.19
CD20M6-BR	CF20M6-BR		2	5.2	.20	1.089.1305.19
CD20M7-BR	CF20M7-BR		2	3.8	.15	1.089.1306.19
CD20M8-BR	CF20M8-BR		2	4.2	.17	1.089.1307.19
CD20M9-BR	CF20M9-BR		2	2.5	.10	1.089.1308.19
CD20MP-BR	CF20MP-BR		Solid Insert		1.089.1399.19	
CD22M1-BR	CF22M1-BR	M20 X 1.5 (Enlarged)	3	3.0	.12	1.089.1600.19
CD22M2-BR	CF22M2-BR		3	4.0	.16	1.089.1601.19
CD22M3-BR	CF22M3-BR		4	4.0	.16	1.089.1602.19
CD22M4-BR	CF22M4-BR		5	4.0	.16	1.089.1603.19
CD22M5-BR	CF22M5-BR		6	4.0	.16	1.089.1604.19
CD22M6-BR	CF22M6-BR		2	6.0	.24	1.089.1605.19
CD22M7-BR	CF22M7-BR		3	5.6	.22	1.089.1606.19
CD22M8-BR	CF22M8-BR		6	3.0	.12	1.089.1607.19
CD22M9-BR	CF22M9-BR		*4	3.0	.12	*1.089.1610.19
CD22M0-BR	CF22M0-BR		6	3.8	.15	1.089.1609.19
CD22MP-BR	CF22MP-BR	Solid Insert		1.089.1699.19		

*This Insert has slotted holes.

**Flex Fittings are not a standard item, assembly required.

*CSA and CE Approvals only applies to Dome Fittings.

Part Numbers		Thread Type & Size	Dimensions in Inches (mm)			
-40°F to 212°F (-40°C to 100°C)			No. of Holes	Diameter of Holes		Part Numbers of Inserts Only
Dome	Flex**	mm		Inches		
CD25M1-BR	CF25M1-BR	M25 X 1.5	4	6.0	.24	1.089.2100.19
CD25M2-BR	CF25M2-BR		3	7.0	.28	1.089.2101.19
CD25M3-BR	CF25M3-BR		2	8.0	.31	1.089.2102.19
CD25M4-BR	CF25M4-BR		4	5.0	.20	1.089.2103.19
CD25M5-BR	CF25M5-BR		1	8.0	.31	1.089.2104.19
CD25M6-BR	CF25M6-BR		4	5.2	.20	1.089.2105.19
CD25M7-BR	CF25M7-BR		3	5.2	.20	1.089.2106.19
CD25M8-BR	CF25M8-BR		4/1	5.2/3.7	.20/.15	1.089.2107.19
CD25M9-BR	CF25M9-BR		2	7.4	.29	1.089.2108.19
CD25MP-BR	CF25MP-BR		Solid Insert		1.089.2199.19	
CD32M1-BR	-	M32 X 1.5	6	6.5	.26	1.089.2900.19
CD32M2-BR	-		4	9.0	.35	1.089.2901.19
CD32M3-BR	-		4	9.5	.37	1.089.2902.19
CD32MP-BR	-		Solid Insert		1.089.2908.19	
CD40M1-BR	-	M40 X 1.5	5	9.0	.35	1.089.3600.19
CD40M2-BR	-		7	9.0	.35	1.089.3601.19
CD40M3-BR	-		6	8.0	.31	1.089.3602.19
CD40M4-BR	-		2	15.0	.59	1.089.3603.19
CD40MP-BR	-		Solid Insert		1.089.3699.19	
CD50M1-BR	-	M50 X 1.5	3	14.0	.55	1.089.4203.19
CD50MP-BR	-		Solid Insert		1.089.4299.19	
CD63M1-BR	-	M63 X 1.5	8	10.0	.39	1.089.4800.19
CD63M2-BR	-		6	12.0	.47	1.089.4801.19
CD63M3-BR	-		3	18.0	.71	1.089.4802.19
CD63MP-BR	-		Solid Insert		1.089.4899.19	

RJ45 Solution

Part Numbers		Thread Type & Size	Dimensions in Inches (mm)		
-40°F to 212°F (-40°C to 100°C)			Cable Diameter		Part Numbers of Inserts Only
Dome	Flex**	mm	Inches		
CD22MK-BR		M20 X 1.5	5.7	.23	1.089.16C-06
CD22MJ-BR		(Enlarged)	6.9	.27	1.089.16C-07

*RJ45 Solution has no approval ratings. Reference Diagram below.

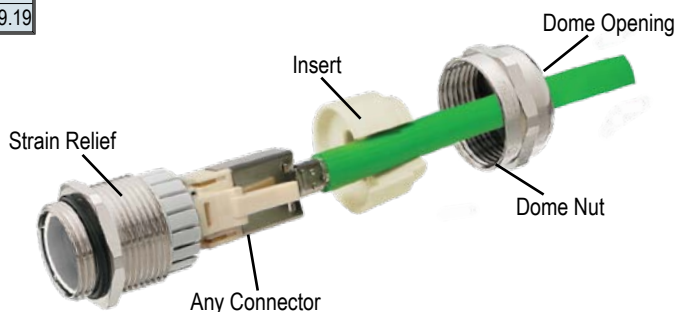

Optional Locking Nuts, O-Rings & Other Accessories starting on Page 29 - 40.

Dome Fittings also available with the following approvals:



www.SealconEX.com

For Material Specifications and Approval Information refer to page 52.



PVDF Body w/ FKM Insert: High/Low Temperature & Chemical Resistant

Part Numbers		Cable Range Inches (mm)	Thread Type & Size See page 56 for thread specs	Dimensions in Inches (mm)				
-31°F to 302°F (-35°C to 150°C)				A Clearance Hole +.01" (+.25 mm)	B Body Length (Dome)	C Body Length (Flex)	TL Thread Length	F ₁ /F
Dome	Flex							
CD07AA-TE	CF07AA-TE	.12 - .26 (3 - 6.5)	PG 7 / 1/4" NPT	.49 (12.5)	.83 (21)	2.13 (54)	.31 (8)	.59 (15)
CD07AR-TE	CF07AR-TE	.08 - .20 (2 - 5)						
CD09AA-TE	-	.16 - .31 (4 - 8)	PG 9	.60 (15.2)	.87 (22)	2.48 (66)	.31 (8)	.75 (19)
CD09AR-TE	-	.08 - .24 (2 - 6)						
CD11AA-TE	-	.20 - .39 (5 - 10)	PG 11	.73 (18.5)	.98 (25)	-	.31 (8)	.87 (22)
CD11AR-TE	-	.12 - .28 (3 - 7)						
CD13AA-TE	-	.24 - .47 (6 - 12)	PG 13 / 13.5	.80 (20.3)	1.06 (27)	3.54 (90)	.35 (9)	.94 (24)
CD13AR-TE	-	.20 - .35 (5 - 9)						
CD16AA-TE	-	.39 - .55 (10 - 14)	PG 16	.89 (22.5)	1.10 (28)	-	.39 (10)	1.06 (27)
CD16AR-TE	-	.28 - .47 (7-12)						
CD21AA-TE	-	.51 - .71 (13 - 18)	PG 21	1.12 (28.4)	1.22 (31)	-	.43 (11)	1.30 (33)
CD21AR-TE	-	.35 - .63 (9 - 16)						
CD29AA-TE	-	.71 - .98 (18 - 25)	PG 29	1.47 (37.3)	1.54 (39)	-	.43 (11)	1.65 (42)
CD29AR-TE	-	.51 - .79 (13 - 20)						
CD36AA-TE	-	.87 - 1.26 (22 - 32)	PG 36	1.85 (47)	1.89 (48)	-	.51 (13)	2.09 (53)
CD36AR-TE	-	.79 - 1.02 (20 - 26)						
CD42AA-TE	-	1.26 - 1.50 (32 - 38)	PG 42	2.13 (54.1)	1.93 (49)	-	.51 (13)	2.36 (60)
CD42AR-TE	-	.98 - 1.22 (25 - 31)						
CD48AA-TE	-	1.46 - .73 (37 - 44)	PG 48	2.34 (59.4)	1.93 (49)	-	.55 (14)	2.56 (65)
CD48AR-TE	-	1.14 - 1.38 (29 - 35)						
CD09NA-TE	-	.16 - .31 (4 - 8)	3/8" NPT	.68 (17.2)	.87 (22)	2.13 (54)	.59 (15)	.75 (19) / .87 (22)
CD09NR-TE	-	.08 - .24 (2 - 6)						
CD13NA-TE	-	.24 - .47 (6 - 12)	1/2" NPT	.83 (21.1)	1.06 (27)	2.48 (63)	.51 (13)	.94 (24)
CD13NR-TE	-	.20 - .35 (5 - 9)						
CD16NA-TE	-	.39 - .55 (10 - 14)	1/2" NPT	.83 (21.1)	1.10 (28)	-	.51 (13)	1.06 (27)
CD16NR-TE	-	.28 - .47 (7-12)						
CD21NA-TE	-	.51 - .71 (13 - 18)	3/4" NPT	1.05 (26.7)	1.22 (31)	-	.51 (13)	1.30 (33)
CD21NR-TE	-	.35 - .63 (9 - 16)						
CD12MA-TE	CF12MA-TE	.12 - .26 (3 - 6.5)	M12 X 1.5	.47 (12)	.83 (21)	2.13 (54)	.31 (8)	.59 (15)
CD12MR-TE	CF12MR-TE	.08 - .20 (2 - 5)						
CD16MA-TE	-	.16 - .31 (4 - 8)	M16 X 1.5	.63 (16)	.87 (22)	2.48 (63)	.31 (8)	.75 (19)
CD16MR-TE	-	.08 - .24 (2 - 6)						
CD20MA-TE	-	.24 - .47 (6 - 12)	M20 X 1.5	.79 (20)	1.06 (27)	3.54 (90)	.35 (9)	.94 (24)
CD20MR-TE	-	.20 - .35 (5 - 9)						
CD25MA-TE	-	.51 - .71 (13 - 18)	M25 X 1.5	.98 (25)	1.22 (31)	-	.43 (11)	1.30 (33)
CD25MR-TE	-	.35 - .63 (9 - 16)						
CD32MA-TE	-	.71 - .98 (18 - 25)	M32 X 1.5	1.26 (32)	1.54 (39)	-	.43 (11)	1.65 (42)
CD32MR-TE	-	.51 - .79 (13 - 20)						

Typical Application:

- Food & Beverage Industries
- Clean Room Applications
- High Temp. Applications
- V0 Rated



PVDF / Stainless Steel

*UL, CSA, UR, CE, and German Lloyd Approvals apply to Dome Fittings.
*VDE Approval only applies to Dome Fittings with Metric Threads.

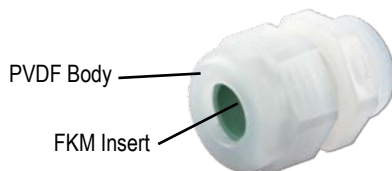
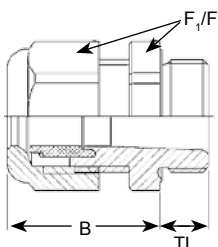

Suggested Clearance Hole for Non-Threaded Mounting

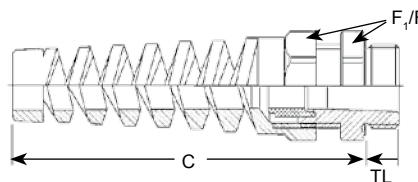



For Material Specifications and Approval Information refer to page 52.

Nickel Plated Brass w/ PVDF - Strain Relief Fittings

PG / NPT / Metric & Elongated Threads



PVDF Spline w/ FKM Insert: High/Low Temperature & Chemical Resistant

Part Numbers		Cable Range Inches (mm)	Thread Type & Size See page 56 for thread specs	Dimensions in Inches (mm)				
-31°F to 302°F (-35°C to 150°C)				A Clearance Hole +.01" (+.25 mm)	B Body Length	TL Thread Length	TL Thread Length	F ₁ /F Wrench Flats
								
CD07AA-RV	CD07CA-RV	.12 - .26 (3 - 6.5)	PG 7 / 1/4" NPT	.49 (12.5)	.75 (19)	.20 (5)	.39 (10)	.55 (14)
CD07AR-RV	CD07CR-RV	.08 - .20 (2 - 5)						
CD09AA-RV	CD09CA-RV	.16 - .31 (4 - 8)	PG 9	.60 (15.2)	.83 (21)	.24 (6)	.39 (10)	.67 (17)
CD09AR-RV	CD09CR-RV	.08 - .24 (2 - 6)						
CD11AA-RV	CD11CA-RV	.20 - .39 (5 - 10)	PG 11	.73 (18.5)	.87 (22)	.24 (6)	.39 (10)	.79 (20)
CD11AR-RV	CD11CR-RV	.12 - .28 (3 - 7)						
CD13AA-RV	CD13CA-RV	.24 - .47 (6 - 12)	PG 13 / 13.5	.80 (20.3)	.94 (24)	.26 (6.5)	.39 (10)	.87 (22)
CD13AR-RV	CD13CR-RV	.20 - .35 (5 - 9)						
CD16AA-RV	CD16CA-RV	.39 - .55 (10 - 14)	PG 16	.89 (22.5)	.91 (23)	.26 (6.5)	.39 (10)	.94 (24)
CD16AR-RV	CD16CR-RV	.28 - .47 (7-12)						
CD21AA-RV	CD21CA-RV	.51 - .71 (13 - 18)	PG 21	1.12 (28.4)	.94 (24)	.28 (7)	.47 (12)	1.18 (30)
CD21AR-RV	CD21CR-RV	.35 - .63 (9 - 16)						
CD29AA-RV	CD29CA-RV	.71 - .98 (18 - 25)	PG 29	1.47 (37.3)	1.14 (29)	.31 (8)	.47 (12)	1.57 (40)
CD29AR-RV	CD29CR-RV	.51 - .79 (13 - 20)						
CD36AA-RV	CD36CA-RV	.87 - 1.26 (22 - 32)	PG 36	1.85 (47)	1.38 (35)	.31 (8)	.59 (15)	1.97 (50)
CD36AR-RV	CD36CR-RV	.79 - 1.02 (20 - 26)						
CD42AA-RV	CD42CA-RV	1.26 - 1.50 (32 - 38)	PG 42	2.13 (54.1)	1.46 (37)	.35 (9)	.59 (15)	2.24 (57)
CD42AR-RV	CD42CR-RV	.98 - 1.22 (25 - 31)						
CD48AA-RV	CD48CA-RV	1.46 - 1.73 (37 - 44)	PG 48	2.34 (59.4)	1.50 (38)	.39 (10)	.59 (15)	2.52 (64)
CD48AR-RV	CD48CR-RV	1.14 - 1.38 (29 - 35)						
CD09NA-RV	-	.16 - .31 (4 - 8)	3/8" NPT	.68 (17.2)	.83 (21)	.59 (15)	-	.67 (17) / .75 (19)
CD09NR-RV	-	.08 - .20 (2 - 6)						
CD13NA-RV	-	.24 - .47 (6 - 12)	1/2" NPT	.83 (21.1)	.94 (24)	.51 (13)	-	.87 (22) / .94 (24)
CD13NR-RV	-	.20 - .35 (5 - 9)						
CD21NA-RV	-	.51 - .71 (13 - 18)	3/4" NPT	1.05 (26.7)	.98 (25)	.51 (13)	-	1.18 (30)
CD21NR-RV	-	.35 - .63 (9-16)						
CD12MA-RV	CD12DA-RV	.12 - .26 (3 - 6.5)	M12 X 1.5	.47 (12)	.75 (19)	.26 (6.5)	.39 (10)	.55 (14)
CD12MR-RV	CD12DR-RV	.08 - .20 (2 - 5)						
CD16MA-RV	CD16DA-RV	.16 - .31 (4 - 8)	M16 X 1.5	.63 (16)	.83 (21)	.24 (6)	.39 (10)	.67 (17) / .75 (19)
CD16MR-RV	CD16DR-RV	.08 - .24 (2 - 6)						
CD17MA-RV	CD17DA-RV	.20 - .39 (5 - 10)	M16 X 1.5	.63 (16)	.87 (22)	.24 (6)	.39 (10)	.79 (20)
CD17MR-RV	CD17DR-RV	.12 - .28 (3 - 7)						
CD20MA-RV	CD20DA-RV	.24 - .47 (6 - 12)	M20 X 1.5	.79 (20)	.91 (23)	.24 (6)	.39 (10)	.87 (22)
CD20MR-RV	CD20DR-RV	.20 - .35 (5 - 9)						
CD22MA-RV	CD22DA-RV	.39 - .55 (10 - 14)	M20 X 1.5	.79 (20)	.94 (24)	.24 (6)	.39 (10)	.94 (24)
CD22MR-RV	CD22DR-RV	.28 - .47 (7-12)						
CD25MA-RV	CD25DA-RV	.51 - .71 (13 - 18)	M25 X 1.5	.98 (25)	1.02 (25)	.28 (7)	.47 (12)	1.18 (30)
CD25MR-RV	CD25DR-RV	.35 - .63 (9 - 16)						
CD32MA-RV	CD32DA-RV	.71 - .98 (18 - 25)	M32 X 1.5	1.26 (32)	1.22 (31)	.31 (8)	.47 (12)	1.57 (40)
CD32MR-RV	CD32DR-RV	.51 - .79 (13 - 20)						
CD40MA-RV	CD40DA-RV	.87 - 1.26 (22 - 32)	M40 X 1.5	1.57 (40)	1.46 (37)	.31 (8)	.59 (15)	1.97 (50)
CD40MR-RV	CD40DR-RV	.79 - 1.02 (20 - 26)						

- Benefits:**
- High Performance
 - Extreme Temp.
 - Rugged
 - Chemical Apps.

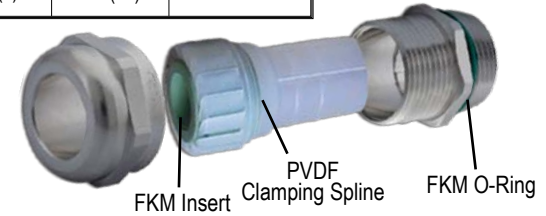
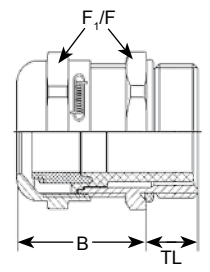

*VDE Approval only applies to Dome Fittings with Metric Threads.

Dome Fittings also available with the following approvals:

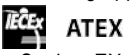

www.SealconEX.com

For Material Specifications and Approval Information refer to page 52.

PVDF / Stainless Steel



Stainless Steel Strain Relief Fittings can be used in many applications, where the environment dictates a corrosion proof solution.

Typical Application:

- Off-shore
- Marine
- Chemical Plants
- Food Processing
- Clean Room
- Other Rugged Applications

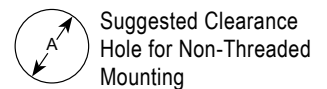
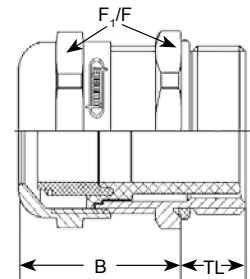

(303) INOX Stainless Steel
also available in **NPT Threads**
upon request.



Stainless Steel: Outer High Performance, High/Low Temp. & Corrosion Resistant

Part Numbers		Cable Range Inches (mm)	Thread Type & Size See page 56 for thread specs	Dimensions in Inches (mm)			
-40°F to 212°F (-40°C to 100°C)	-31°F to 302°F (-35°C to 150°C)			A Clearance Hole +.01" (+.25 mm)	B Body Length	TL Thread Length	F ₁ /F Wrench Flats
CD07AA-SS	CD07AA-SV	.12 - .26 (3 - 6.5)	PG 7	.49 (12.5)	.75 (19)	.20 (5)	.55 (14)
CD07AR-SS	CD07AR-SV	.08 - .20 (2 - 5)					
CD09AA-SS	CD09AA-SV	.16 - .31 (4 - 8)	PG 9	.60 (15.2)	.83 (21)	.24 (6)	.67 (17)
CD09AR-SS	CD09AR-SV	.08 - .24 (2 - 6)					
CD11AA-SS	CD11AA-SV	.20 - .39 (5 - 10)	PG 11	.73 (18.5)	.87 (22)	.24 (6)	.87 (22)
CD11AR-SS	CD11AR-SV	.12 - .28 (3 - 7)					
CD13AA-SS	CD13AA-SV	.24 - .47 (6 - 12)	PG 13 / 13.5	.80 (20.3)	.94 (24)	.26 (6.5)	.87 (22)
CD13AR-SS	CD13AR-SV	.20 - .35 (5 - 9)					
CD16AA-SS	CD16AA-SV	.39 - .55 (10 - 14)	PG 16	.89 (22.5)	.91 (23)	.26 (6.5)	.94 (24)
CD16AR-SS	CD16AR-SV	.28 - .47 (7-12)					
CD21AA-SS	CD21AA-SV	.51 - .71 (13 - 18)	PG 21	1.12 (28.4)	.94 (24)	.28 (7)	1.18 (30)
CD21AR-SS	CD21AR-SV	.35 - .63 (9 - 16)					
CD29AA-SS	CD29AA-SV	.71 - .98 (18 - 25)	PG 29	1.47 (37.3)	1.14 (29)	.31 (8)	1.61 (41)
CD29AR-SS	CD29AR-SV	.51 - .79 (13 - 20)					
CD36AA-SS	CD36AA-SV	.87 - 1.26 (22 - 32)	PG 36	1.85 (47)	1.38 (35)	.31 (8)	1.97 (50)
CD36AR-SS	CD36AR-SV	.79 - 1.02 (20 - 26)					
CD42AA-SS	CD42AA-SV	1.26 - 1.50 (32 - 38)	PG 42	2.13 (54.1)	1.46 (37)	.35 (9)	2.24 (57)
CD42AR-SS	CD42AR-SV	.98 - 1.22 (25 - 31)					
CD48AA-SS	CD48AA-SV	1.46 - 1.73 (37 - 44)	PG 48	2.34 (59.4)	1.50 (38)	.39 (10)	2.52 (64)
CD48AR-SS	CD48AR-SV	1.14 - 1.38 (29 - 35)					
CD12MA-SS	CD12MA-SV	.12 - .26 (3 - 6.5)	M12 X 1.5	.47 (12)	.75 (19)	.26 (6.5)	.55 (14)
CD12MR-SS	CD12MR-SV	.08 - .20 (2 - 5)					
CD16MA-SS	CD16MA-SV	.20 - .39 (5 - 10)	M16 X 1.5	.63 (16)	.87 (22)	.24 (6)	.87 (22)
CD16MR-SS	CD16MR-SV	.12 - .28 (3 - 7)					
CD20MA-SS	CD20MA-SV	.39 - .55 (10 - 14)	M20 X 1.5	.79 (20)	.91 (23)	.24 (6)	.94 (24)
CD20MR-SS	CD20MR-SV	.28 - .47 (7-12)					
CD25MA-SS	CD25MA-SV	.51 - .71 (13 - 18)	M25 X 1.5	.98 (25)	.94 (24)	.28 (7)	1.18 (30)
CD25MR-SS	CD25MR-SV	.35 - .63 (9 - 16)					
CD32MA-SS	CD32MA-SV	.71 - .98 (18 - 25)	M32 X 1.5	1.26 (32)	1.22 (31)	.31 (8)	1.61 (47)
CD32MR-SS	CD32MR-SV	.51 - .79 (13 - 20)					
CD40MA-SS	CD40MA-SV	.87 - 1.26 (22 - 32)	M40 X 1.5	1.57 (40)	1.46 (37)	.31 (8)	1.97 (50)
CD40MR-SS	CD40MR-SV	.79 - 1.02 (20 - 26)					
CD50MA-SS	-	1.26 - 1.50 (32 - 38)	M50 X 1.5	1.97 (50)	1.46 (37)	.35 (9)	2.36 (60)
CD50MR-SS	-	.98 - 1.22 (25 - 31)					
CD63MA-SS	-	1.46 - 1.73 (37 - 44)	M63 X 1.5	2.48 (63)	1.50 (38)	.39 (10)	2.52 (64) / 2.68 (68)
CD63MR-SS	-	1.14 - 1.38 (29 - 35)					

*CSA and CE Approvals only applies to Standard Fittings.

*VDE Approval only applies to Dome Fittings with Metric Threads.

Part Numbers		Cable Range Inches (mm)	Thread Type & Size See page 56 for thread specs	Dimensions in Inches (mm)			
-40°F to 212°F (-40°C to 100°C)	-31°F to 302°F (-35°C to 150°C)			A Clearance Hole +.01" (+.25 mm)	B Body Length	TL Thread Length	F ₁ /F Wrench Flats
CD09NA-6S	CD09NA-6V	.16 - .31 (4 - 8)	3/8" NPT	.68 (17.2)	.83 (21)	.59 (15)	.67 (17) / .75 (19)
CD09NR-6S	CD09NR-6V	.08 - .24 (2 - 6)					
CD13NA-6S	CD13NA-6V	.24 - .47 (6 - 12)	1/2" NPT	.83 (21.1)	.94 (24)	.51 (13)	.87 (22) / .94 (24)
CD13NR-6S	CD13NR-6V	.20 - .35 (5 - 9)					
CD21NA-6S	CD21NA-6V	.51 - .71 (13 - 18)	3/4" NPT	1.05 (26.7)	.98 (25)	.51 (13)	1.18 (30)
CD21NR-6S	CD21NR-6V	.35 - .63 (9 - 16)					
CD29NA-6S	-	.71 - .98 (18 - 25)	1" NPT	1.35 (34.3)	1.14 (29)	.75 (19)	1.61 (41)
CD29NR-6S	-	.51 - .79 (13 - 20)					

The 316L material is much harder and ideal for direct exposure to salt water and chemical solutions in marine, off-shore, pharmaceutical, etc.

Dome Fittings also available with the following approvals:



www.SealconEX.com

(316L) INOX Stainless Steel also available in **PG and Metric Threads** upon request.



Optional Locking Nuts, O-Rings & Other Accessories starting on Page 29 - 40.

316L Stainless Steel - Hygienic Cable Glands

RG/FP Hygienic Glands - Metric Threads



PVDF / Stainless Steel



RG Gland							
Part Numbers	Cable Range	Thread Type & Size	Dimensions in Inches (mm)				
			A	TL	B	E	F
-40°F to 248°F (-40°C to 120°C)			Clearance Hole +.01" (+.25 mm)	Thread Length	Body Length	Body Diameter	Wrench Flat
	Inches (mm)	See page 56 for thread specs					
RG12MA-6S	.20 - .26 (5 - 6.5)	M12 x 1.5	.47 (12)	.24 (6)	.75 (19)	.83 (21)	.55 (14)
RG17MA-6S	.30 - .40 (7.5 - 10)	M16 x 1.5	.63 (16)	.24 (6)	.79 (20)	1.06 (27)	.75 / .83 (19 / 21)
RG17MR-6S	.24 - .30 (6 - 7.5)	M16 x 1.5	.63 (16)	.24 (6)	.79 (20)	1.06 (27)	.75 / .83 (19 / 21)
RG22MA-6S	.43 - .53 (11 - 13.5)	M20 x 1.5	.79 (20)	.24 (6)	.89 (22.5)	1.30 (33)	.94 / 1.06 (24 / 27)
RG22MR-6S	.35 - .47 (9 - 12)	M20 x 1.5	.79 (20)	.24 (6)	.89 (22.5)	1.30 (33)	.94 / 1.06 (24 / 27)
RG25MA-6S	.60 - .71 (15 - 18)	M25 x 1.5	.98 (25)	.28 (7)	.93 (23.5)	1.50 (38)	1.18 (30)
RG25MK-6S	.55 - .63 (14 - 16)	M25 x 1.5	.98 (25)	.28 (7)	.93 (23.5)	1.50 (38)	1.18 (30)
RG25MR-6S	.51" - .59" (13 - 15)	M25 x 1.5	.98 (25)	.28 (7)	.93 (23.5)	1.50 (38)	1.18 (30)
RG32MA-6S	.83 - .99 (21 - 25)	M32 x 1.5	1.26 (32)	.31 (8)	1.04 (26.5)	1.77 (45)	1.42 (36)
RG32MR-6S	.71 - .83 (18 - 21)	M32 x 1.5	1.26 (32)	.31 (8)	1.04 (26.5)	1.77 (45)	1.42 (36)

- High pressure IP 68 & IP 69K
- EMI ready for braided cable
- 316 L Stainless Steel
- High-Quality silicone sealing
- UL Certified. File # 103997
- EHEDG Certified
- FDA Compliant Materials

****EMI Option Integrated**
VDMA Riboflavin cleaning test passed
EHEDG 01 cleaning test passed
EHEDG certificate EL class 1 AUX approved



UL Certified!

IP 68 & IP 69K



 Suggested Clearance Hole for Non-Threaded Mounting

RG GLAND
HYGIENIC DESIGN

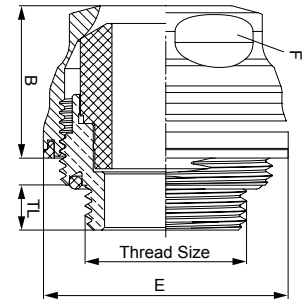

316L Stainless Steel - Hygienic Cable Glands

FP Gland - Metric Threads



FP Gland							
Part Numbers	Cable Range	Thread Type & Size	Dimensions in Inches (mm)				
			A	TL	B	E	F
-40°F to 248°F (-40°C to 120°C)			Clearance Hole +.01" (+.25 mm)	Thread Length	Body Length	Body Diameter	Wrench Flat
	Inches (mm)	See page 56 for thread specs					
FP12MA-6S	.14 - .26 (3.5 - 6.5)	M12 x 1.5	.47 (12)	.24 (6)	1.18 (30)	.83 (21)	.55 (14)
FP17MA-6S	.20 - .40 (5 - 10)	M16 x 1.5	.63 (16)	.24 (6)	1.34 (34)	1.06 (27)	.71 / .79 (18 / 20)
FP22MA-6S	.40 - .55 (10 - 14)	M20 x 1.5	.79 (20)	.24 (6)	1.36 (34.5)	1.30 (33)	.94 (24)
FP25MA-6S	.51 - .71 (13 - 18)	M25 x 1.5	.98 (25)	.28 (7)	1.63 (41.5)	1.50 (38)	1.06 / 1.18 (27 / 30)

- Perfect for Foam Cleaning
- EMI ready for braided cable
- No more waterpooling
- The elastic membrane seal avoids cable slipping while also being liquid tight
- FDA Compliant material



IP 68







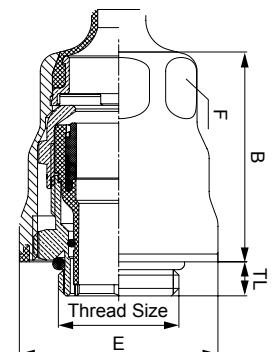





 Suggested Clearance Hole for Non-Threaded Mounting



FP GLAND
HYGIENIC DESIGN



For Material Specifications and Approval Information refer to page 52.

	Locking Nuts - Page 29 · Black & Gray Nylon · Nickel Plated Brass	
	O-Rings - Page 31 · Buna-N · Silicone · FKM	
	Hole Plug - Page 32-34 Dome Plugs: · Buna-N · FKM Hex Plugs: · Black Nylon · Nickel Plated Brass · Stainless Steel	
	Wrenches - Page 34 · Deep Socket Wrenches	
	Thread Reducers - Page 37-39 Reduces a Type of (NPT, PG, Metric) · Gray Nylon · Black Nylon · FKM · Stainless Steel	
	Page 30 - Locking Nuts EMI/RFI Proof (Nickel Plated Brass) · Zinc Plated Steel · Stainless Steel (303) - INOX	
	Page 31 - Seal Rings Polyethylene · Fiber-Reinforced Plastic	
	Page 32-33 - Blind Plug/Clamp Blind Plugs: · Black Nylon Cable Clamp: Nickel Plated Brass	
	Page 35-36 - Thread Adapters Converts a Type of (NPT, PG, Metric) Threads · Black Nylon · Nickel Plated Brass	
	Page 40 - Thread Enlargers Enlarges a Type of (NPT, PG, Metric) Threads · Black Nylon · Nickel Plated Brass	

Accessories - Locking Nuts Nylon & Nickel Plated Brass - PG / NPT / Metric Threads

Nylon: Black & Gray Locking Nuts*				
Part Numbers		Thread Type & Size	Dimens. Inches (mm)	
-40°F to 212°F (-40°C to 100°C)			G	F
		See page 56 for thread specs	Thickness	Wrench Flats
NP-07-BK	NP-07-GY		PG 7	.20 (5)
NP-09-BK	NP-09-GY	PG 9	.20 (5)	.87 (22)
NP-11-BK	NP-11-GY	PG 11	.20 (5)	.94 (24)
NP-13-BK	NP-13-GY	PG 13 / 13.5	.24 (6)	1.06 (27)
NP-16-BK	NP-16-GY	PG 16	.24 (6)	1.18 (30)
NP-21-BK	NP-21-GY	PG 21	.28 (7)	1.41 (36)
NP-29-BK	NP-29-GY	PG 29	.28 (7)	1.81 (46)
NP-36-BK	NP-36-GY	PG 36	.31 (8)	2.36 (60)
NP-42-BK	NP-42-GY	PG 42	.31 (8)	2.56 (65)
NP-48-BK	NP-48-GY	PG 48	.31 (8)	2.76 (70)
<hr/>				
NN-09-BK	NN-09-GY	3/8" NPT	.28 (7)	.94 (24)
NN-13-BK	NN-13-GY	1/2" NPT	.24 (6)	1.06 (27)
NN-21-BK	NN-21-GY	3/4" NPT	.28 (7)	1.26 (32)
NN-29-BK	NN-29-GY	1" NPT	.28 (7)	1.57 (40)
<hr/>				
NM-12-BK	NM-12-GY	M12 X 1.5	19 (4.79)	.86 (22)
NM-16-BK	NM-16-GY	M16 X 1.5	.20 (5)	.87 (22)
NM-20-BK	NM-20-GY	M20 X 1.5	.24 (6)	1.06 (27)
NM-25-BK	NM-25-GY	M25 X 1.5	.26 (6.5)	1.26 (32)
NM-32-BK	NM-32-GY	M32 X 1.5	.28 (7)	1.61 (41)
NM-40-BK	NM-40-GY	M40 X 1.5	.28 (7)	1.97 (50)
NM-50-BK	NM-50-GY	M50 X 1.5	.31 (8)	2.36 (60)
NM-63-BK	NM-63-GY	M63 X 1.5	.31 (8)	2.95 (75)

* V0 Rated

Additional: Nickel Plated Brass Extra Small & Large Locking Nuts are available in Metric: (M6, M8, M10, M63, M75, M80, M90, M100, M110). See Page 15.

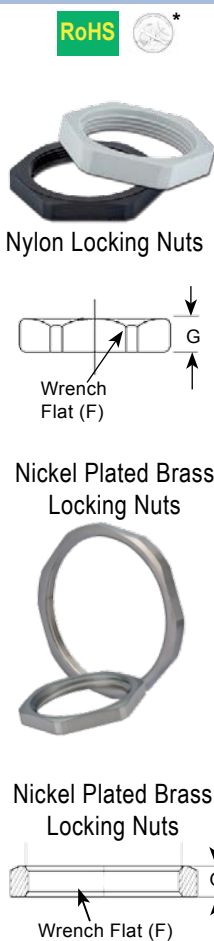

Nickel Plated Brass: Locking Nuts				
Part Numbers		Thread Type & Size	Dimens. Inches (mm)	
Nickel Plated Brass			G	F
		See page 56 for thread specs	Thickness	Wrench Flats
NP-07-BR	PG 7		.11 (2.8)	.59 (15)
NP-09-BR	PG 9	.11 (2.8)	.71 (18)	
NP-11-BR	PG 11	.12 (3)	.83 (21)	
NP-13-BR	PG 13 / 13.5	.12 (3)	.91 (23)	
NP-16-BR	PG 16	.12 (3)	1.02 (26)	
NP-21-BR	PG 21	.14 (3.5)	1.26 (32)	
NP-29-BR	PG 29	.16 (4)	1.61 (41)	
NP-36-BR	PG 36	.20 (5)	2.01 (51)	
NP-42-BR	PG 42	.20 (5)	2.36 (60)	
NP-48-BR	PG 48	.22 (5.5)	2.52 (64)	
<hr/>				
NN-09-BR	3/8" NPT	.19 (4.79)	.82 (22)	
NN-13-BR	1/2" NPT	.12 (3)	.94 (24)	
NN-21-BR	3/4" NPT	.14 (3.5)	1.18 (30)	
NN-29-BR	1" NPT	.14 (3.5)	1.38 (35)	
<hr/>				
NM-06-BR	M6 X 1.0	.10 (2.5)	.39 (10)	
NM-08-BR	M8X1.25	.10 (2.5)	.51 (13)	
NM-10-BR	M10 X 1.5	.11 (2.8)	.51 (13)	
NM-12-BR	M12 X 1.5	.11 (2.8)	.59 (15)	
NM-16-BR	M16 X 1.5	.11 (2.8)	.75 (19)	
NM-20-BR	M20 X 1.5	.12 (3)	.91 (23)	
NM-25-BR	M25 X 1.5	.14 (3.5)	1.14 (29)	
NM-32-BR	M32 X 1.5	.16 (4)	1.42 (36)	
NM-40-BR	M40 X 1.5	.18 (4.5)	1.77 (45)	
NM-50-BR	M50 X 1.5	.22 (5.5)	2.17 (55)	
NM-63-BR	M63 X 1.5	.24 (6)	2.76 (70)	

* German Lloyd only applies to Nickel Plated Brass Locking Nuts.

For Material Specifications and Approval Information refer to page 52.

EMI/RFI - Nickel Plated Brass: Locking Nuts				
Part Numbers	Thread Type & Size	Dimens. Inches (mm)		
		G	F	H
	See page 56 for thread specs	Thickness	Wrench Flats	Cutting Edge Height
NP-07-BE		PG 7	.11 (2.8)	.59 (15)
NP-09-BE	PG 9	.11 (2.8)	.71 (18)	.028 (0.7)
NP-11-BE	PG 11	.12 (3)	.83 (21)	.028 (0.7)
NP-13-BE	PG 13 / 13.5	.12 (3)	.91 (23)	.028 (0.7)
NP-16-BE	PG 16	.12 (3)	1.02 (26)	.028 (0.7)
NP-21-BE	PG 21	.14 (3.5)	1.26 (32)	.028 (0.7)
NP-29-BE	PG 29	.16 (4)	1.61 (41)	.028 (0.7)
NP-36-BE	PG 36	.20 (5)	2.01 (51)	.028 (0.7)
NP-42-BE	PG 42	.20 (5)	2.36 (60)	.028 (0.7)
NP-48-BE	PG 48	.22 (5.5)	2.52 (64)	.028 (0.7)
<hr/>				
NN-13-BE	1/2" NPT	.12 (3)	.94 (24)	.028 (0.7)
<hr/>				
NM-12-BE	M12 X 1.5	.11 (2.8)	.59 (15)	.028 (0.7)
NM-16-BE	M16 X 1.5	.11 (2.8)	.75 (19)	.028 (0.7)
NM-20-BE	M20 X 1.5	.12 (3)	.94 (24)	.028 (0.7)
NM-25-BE	M25 X 1.5	.14 (3.5)	1.18 (30)	.028 (0.7)
NM-32-BE	M32 X 1.5	.18 (4.5)	1.42 (36)	.028 (0.7)
NM-40-BE	M40 X 1.5	.20 (5)	1.81 (46)	.028 (0.7)
NM-50-BE	M50 X 1.5	.20 (5)	2.36 (60)	.028 (0.7)
NM-63-BE	M63 X 1.5	.24 (6)	2.76 (70)	.028 (0.7)

RoHS



These Locking Nuts have cutting edges which will slice through paint coatings on a metal enclosure to ensure grounding. These Locking Nuts are also suitable for applications with lots of vibration.



*BE-Locknuts have the following approvals: CE & German Lloyd.

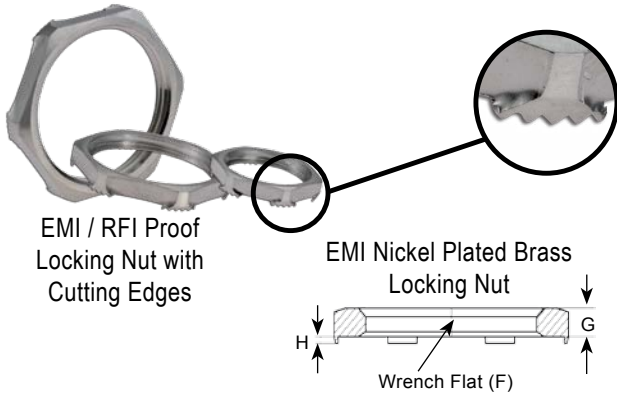

Zinc Plated Steel: Locking Nuts			
Part Numbers	Thread Type & Size	Dimens. Inches (mm)	
		G	F
	See page 56 for thread specs	Thickness	Wrench Flats
NN-10-ST		1" NPT	.24 (6)
NN-34-ST	1-1/4" NPT	.20 (5)	2.01 (53)
NN-36-ST	1-1/2" NPT	.16 (4)	2.19 (55.5)

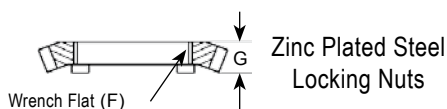



Stainless Steel: Locking Nuts			
Part Numbers	Thread Type & Size	Dimens. Inches (mm)	
		G	F
	See page 56 for thread specs	Thickness	Wrench Flats
NP-07-SS		PG 7	.11 (2.8)
NP-09-SS	PG 9	.11 (2.8)	.87 (22)
NP-11-SS	PG 11	.12 (3)	.87 (22)
NP-13-SS	PG 13 / 13.5	.12 (3)	.94 (24)
NP-16-SS	PG 16	.12 (3)	1.06 (27)
NP-21-SS	PG 21	.14 (3.5)	1.26 (32)
NP-29-SS	PG 29	.16 (4)	1.61 (41)
NP-36-SS	PG 36	.20 (5)	1.97 (50)
<hr/>			
NM-12-SS	M12 X 1.5	.11 (2.8)	.59 (15)
NM-16-SS	M16 X 1.5	.11 (2.8)	.75 (19)
NM-20-SS	M20 X 1.5	.12 (3)	.91 (23)
NM-25-SS	M25 X 1.5	.14 (3.5)	1.14 (29)
NM-32-SS	M32 X 1.5	.16 (4)	1.42 (36)
NM-40-SS	M40 X 1.5	.18 (4.5)	1.77 (45)
NM-50-SS	M50 X 1.5	.22 (5.5)	2.17 (55)
NM-63-SS	M63 X 1.5	.24 (6)	2.76 (70)

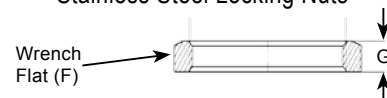

Stainless Steel Locking Nuts



Typical Applications for Stainless Steel:

- Off-shore
- Marine
- Chemical Plants
- Food Processing
- Clean Room
- Other Rugged Applications

Seal Rings: Polyethylene, Fiber-Reinforced Plastic					
Part Numbers		Thread Type & Size	Dimensions Inches (mm)		
-22°F to 158°F (-30°C to 70°C)	-40°F to 572°F (-40°C to 300°C)		d	D	H
		See page 56 for thread specs	Inner Diameter	Outer Diameter	Height
SR-07-NY	SR-07-HD		PG 7	.49 (12.5)	.65 (16.5)
SR-09-NY	SR-09-HD	PG 9	.60 (15.2)	.75 (19)	.06 (1.5)
SR-11-NY	SR-11-HD	PG 11	.73 (18.6)	.89 (22.5)	.06 (1.5)
SR-13-NY	SR-13-HD	PG 13 / 13.5	.80 (20.4)	.98 (25)	.06 (1.5)
SR-16-NY	SR-16-HD	PG 16	.89 (22.5)	1.06 (27)	.06 (1.5)
SR-21-NY	SR-21-HD	PG 21	1.11 (28.3)	1.32 (33.5)	.06 (1.5)
SR-29-NY	SR-29-HD	PG 29	1.46 (37)	1.71 (43.5)	.08 (2)
SR-36-NY	SR-36-HD	PG 36	1.85 (47)	2.17 (55)	.08 (2)
SR-42-NY	SR-42-HD	PG 42	2.13 (54.1)	2.48 (63)	.08 (2)
SR-48-NY	SR-48-HD	PG 48	2.33 (59.3)	2.72 (69)	.08 (2)
SR-38-NY	-	3/8" NPT	.67 (17)	.87 (22)	.06 (1.5)
SR-18-NY	-	1/2" NPT	.83 (21)	.98 (25)	.06 (1.5)
SR-34-NY	-	3/4" NPT	1.06 (27)	1.43 (36)	.04 (1)
SR-10-02	-	1" NPT	1.32 (33.5)	1.71 (43)	.09 (2.2)
SR-14-NY	-	1-1/4" NPT	.63 (41.5)	1.95 (49)	.06 (1.5)
SM-12-NY	SM-12-HD	M12 X 1.5	.47 (12)	.63 (16)	.08 (2)
SM-16-NY	SM-16-HD	M16 X 1.5	.63 (16)	.79 (20)	.08 (2)
SM-20-NY	SM-20-HD	M20 X 1.5	.79 (20)	.98 (25)	.08 (2)
SM-25-NY	SM-25-HD	M25 X 1.5	.98 (25)	1.22 (31)	.08 (2)
SM-32-NY	SM-32-HD	M32 X 1.5	1.26 (32)	1.50 (38)	.08 (2)
SM-40-NY	SM-40-HD	M40 X 1.5	1.57 (40)	1.68 (42.7)	.08 (2)
SM-50-NY	SM-50-HD	M50 X 1.5	1.97 (50)	2.28 (58)	.08 (2)
SM-63-NY	SM-63-HD	M63 X 1.5	2.48 (63)	2.83 (72)	.08 (2)

O-Rings: Buna-N, FKM, Silicone					
Part Numbers			Thread Type & Size	Dimens. Inches (mm)	
-22°F to 248°F (-30°C to 120°C)	-40°F to 392°F (-40°C to 200°C)	-76°F to 482°F (-60°C to 250°C)		d	H
			See page 56 for thread specs	Inner Diameter	Height
OR-07-BN	OR-07-VT	OR-07-SI		PG 7	.39 (10)
OR-09-BN	OR-09-VT	OR-09-SI	PG 9	.47 (12)	.06 (1.5)
OR-11-BN	OR-11-VT	OR-11-SI	PG 11	.63 (16)	.06 (1.5)
OR-13-BN	OR-13-VT	OR-13-SI	PG 13 / 13.5	.67 (17)	.07 (1.8)
OR-16-BN	OR-16-VT	OR-16-SI	PG 16	.71 (18)	.06 (1.5)
OR-21-BN	OR-21-VT	OR-21-SI	PG 21	1.02 (26)	.08 (2)
OR-29-BN	OR-29-VT	OR-29-SI	PG 29	1.30 (33)	.08 (2)
OR-36-BN	OR-36-VT	OR-36-SI	PG 36	1.69 (43)	.08 (2)
OR-42-BN	OR-42-VT	OR-42-SI	PG 42	1.97 (50)	.08 (2)
OR-48-BN	OR-48-VT	OR-48-SI	PG 48	2.16 (55)	.08 (2)
OR-38-BN	OR-38-VT	OR-38-SI	3/8" NPT	.51 (13)	.08 (2)
OR-18-BN	OR-18-VT	OR-18-SI	1/2" NPT	.75 (19)	.07 (1.8)
OR-34-BN	OR-34-VT	OR-34-SI	3/4" NPT	.87 (23)	.078 (2)
OR-10-BN	OR-10-VT	OR-10-SI	1" NPT	1.14 (29)	.078 (2)
OR-54-BN	OR-54-VT	OR-54-SI	1-1/4" NPT	1.50 (38)	.10 (2.5)
OR-64-BN	OR-64-VT	OR-64-SI	1-1/2" NPT	1.77 (45)	.10 (2.5)
OM-12-BN*	OM-12-VT*	OM-12-SI*	M12 X 1.5	.39 (10)	.06 (1.5)
OM-16-BN*	OM-16-VT*	OM-16-SI*	M16 X 1.5	.47 (12)	.06 (1.5)
OM-20-BN*	OM-20-VT*	OM-20-SI*	M20 X 1.5	.67 (17)	.07 (1.8)
OM-25-BN	OM-25-VT	OM-25-SI	M25 X 1.5	.87 (22)	.08 (2)
OM-32-BN	OM-32-VT	OM-32-SI	M32 X 1.5	1.14 (29)	.08 (2)
OM-40-BN	OM-40-VT	OM-40-SI	M40 X 1.5	1.38 (35)	.08 (2)
OM-50-BN	OM-50-VT	OM-50-SI	M50 X 1.5	1.69 (43)	.08 (2)
OM-63-BN	OM-63-VT	OM-63-SI	M63 X 1.5	2.17 (55)	.08 (2)

If Type NEMA 4x or 6 (IP 68 or IP 69K - Submersible) is required, O-Rings or Seal Rings should be used when mounting Strain Relief Fittings to a control panel, secured with a Locking Nut. The straight Strain Relief Fittings feature a molded O-Ring groove. For these fittings the O-Ring is the best solution. The Snap Elbows and some of the Conduit Fittings don't have a recess for an O-Ring. In that case, the Seal Ring would be the better choice, unless the hole can be beveled to accommodate an O-Ring.

*Metal Parts use different O-Rings.

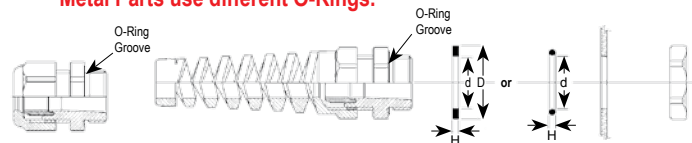

Accessories - Strain Relief Blind Plugs Nylon - Fits PG / NPT / Metric Threads

Part Numbers	Fits PG Thread	Fits NPT Thread	Fits Metric Thread	Dimensions in Inches (mm)		
				D1	D2	L
-40°F to 212°F (-40°C to 100°C)	See page 56 for thread specs	See page 56 for thread specs	See page 56 for thread specs	Diameter (1)	Diameter (2)	Length
PL-07-BK				PG 7	-	M12 x 1.5
PL-09-BK	PG9	3/8" NPT	M16 x 1.5	.26 (7.5)	.22 (5.5)	.67 (17)
PL-11-BK	PG 11	-	M16 x 1.5 - E	.37 (9.5)	.26 (6.5)	.75 (19)
PL-13-BK	PG 13 / 13.5	1/2" NPT	M20 x 1.5	.45 (11.5)	.33 (8.5)	.75 (19)
PL-16-BK	PG 16	1/2" NPT-E	M20 x 1.5 - E	.53 (13.5)	.45 (11.5)	.77 (19.5)
PL-21-BK	PG 21	3/4" NPT	M25 x 1.5	.69 (17.5)	.61 (15.5)	.93 (23.5)
PL-29-BK	PG 29	1" & 1-1/4" NPT	M32 x 1.5	.94 (24)	.75 (19)	1.02 (26)
PL-36-BK	PG 36	1-1/2" NPT	M40 x 1.5	1.22 (31)	.98 (25)	1.10 (28)
PL-42-BK	PG 42	-	M50 x 1.5	1.46 (37)	1.18 (30)	1.10 (28)
PL-48-BK	PG 48	-	M63 x 1.5	1.69 (43)	1.34 (34)	1.10 (28)

RoHS

These non-threaded Plugs are made of Black Nylon (RAL 9005) and fit PG, NPT and Metric Strain Relief Fittings.

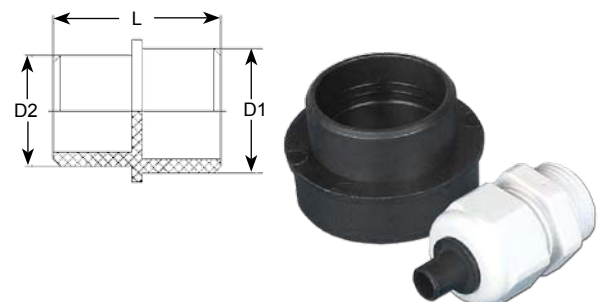

Inserts into Dome Nut for a liquid tight seal!

For Material Specifications and Approval Information refer to page 52.

Dome Plugs: Nylon (No O-Ring Groove) - IP 54						
Part Numbers		Thread Type & Size	Dimensions Inches (mm)			
-40°F to 212°F (-40°C to 100°C)			H	D	TL	
		See page 56 for thread specs	Overall Height	Outer Diameter	Thread Length	
DP-07-BK	DP-07-GY		PG 7	.31 (8)	.59 (15)	.24 (6)
DP-09-BK	DP-09-GY		PG 9	.35 (9)	.75 (19)	.24 (6)
DP-11-BK	DP-11-GY		PG 11	.35 (9)	.87 (22)	.24 (6)
DP-13-BK	DP-13-GY		PG 13 / 13.5	.37 (9.5)	.98 (25)	.24 (6)
DP-16-BK	DP-16-GY		PG 16	.37 (9.5)	1.06 (27)	.24 (6)
DP-21-BK	DP-21-GY		PG 21	.43 (11)	1.30 (33)	.31 (8)
DP-29-BK	DP-29-GY		PG 29	.47 (12)	1.73 (44)	.31 (8)
DP-36-BK	DP-36-GY		PG 36	.59 (15)	2.17 (55)	.39 (10)
DP-42-BK	DP-42-GY		PG 42	.63 (16)	2.44 (62)	.39 (10)
DP-48-BK	DP-48-GY		PG 48	.63 (16)	2.72 (69)	.47 (12)
DM-12-BK	DM-12-GY		M12 x 1.5	.39 (10)	.59 (15)	.24 (6)
DM-16-BK	DM-16-GY		M16 x 1.5	.45 (11.5)	.79 (20)	.28 (7)
DM-20-BK	DM-20-GY		M20 x 1.5	.37 (9.5)	.98 (25)	.24 (6)
DM-25-BK	DM-25-GY		M25 x 1.5	.61 (15.5)	1.18 (30)	.43 (11)
DM-32-BK	DM-32-GY	M32 x 1.5	.63 (16)	1.50 (38)	.43 (11)	
DM-40-BK	DM-40-GY	M40 x 1.5	.71 (18)	1.81 (46)	.51 (13)	
DM-50-BK	DM-50-GY	M50 x 1.5	.73 (18.5)	2.20 (56)	.51 (13)	
DM-63-BK	DM-63-GY	M63 x 1.5	.75 (19)	2.72 (69)	.59 (15)	

Hex Plugs: Nylon					
Part Numbers		Thread Type & Size	Dimensions Inches (mm)		
-4°F to 176°F (-20°C to 80°C)			B	D	TL
		See page 56 for thread specs	Body Length	Wrench Flat	Thread Length
HP-07-BK	PG 7 / 1/4" NPT		.51 (13)	.59 (15)	.33 (8.5)
HP-09-BK	PG 9		.51 (13)	.75 (19)	.33 (8.5)
HP-11-BK	PG 11		.57 (14.5)	.94 (24)	.35 (9)
HP-13-BK	PG 13 / 13.5		.57 (14.5)	.94 (24)	.35 (9)
HP-16-BK	PG 16		.63 (16)	1.10 (28)	.41 (10.5)
HP-21-BK	PG 21		.69 (17.5)	1.42 (36)	.45 (11.5)
HP-29-BK	PG 29		.71 (18)	1.81 (46)	.45 (11.5)
HP-36-BK	PG 36		.79 (20)	2.17 (55)	.53 (13.5)
HP-42-BK	PG 42		.79 (20)	2.36 (60)	.53 (13.5)
HP-48-BK	PG 48		.83 (21)	2.76 (70)	.57 (14.5)
HM-12-BK	M12 x 1.5		.51 (13)	.59 (15)	.33 (8.5)
HM-16-BK	M16 x 1.5		.51 (13)	.75 (19)	.33 (8.5)
HM-20-BK	M20 x 1.5		.57 (14.5)	.94 (24)	.35 (9)
HM-25-BK	M25 x 1.5		.63 (16)	1.10 (28)	.41 (10.5)
HM-32-BK	M32 x 1.5	.69 (17.5)	1.42 (36)	.45 (11.5)	
HM-40-BK	M40 x 1.5	.71 (18)	1.81 (46)	.45 (11.5)	
HM-50-BK	M50 x 1.5	.79 (20)	2.17 (55)	.53 (13.5)	
HM-63-BK	M63 x 1.5	.83 (21)	2.76 (70)	.57 (14.5)	

*Available with an O-Ring Groove

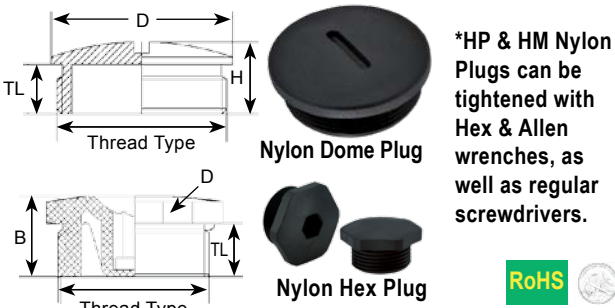

*HP & HM Nylon Plugs can be tightened with Hex & Allen wrenches, as well as regular screwdrivers.



Hex Plugs also available with the following approvals:



www.SealconEX.com

*German Lloyd Approval only applies to Nylon Hex Plugs with PG or Metric Threads.

Part Numbers		Thread Type & Size	Dimensions in Inches (mm)						
-40°F to 176°F (-40°C to 80°C)			H	D	TL	H	D	TL	
		See page 56 for thread specs	Overall Height	Outer Diameter	Thread Length	Overall Height w/ O-Ring	Outer Diameter w/ O-Ring	Thread Length w/ O-Ring	
DM-12-BR	DM-12-BR-B		M12 x 1.5	.30 (7.5)	.55 (14)	.20 (5)	.37 (9.5)	.55 (14)	.26 (6.5)
DM-16-BR	DM-16-BR-B		M16 x 1.5	.35 (9)	.71 (18)	.20 (5)	.35 (9)	.79 (20)	.24 (6)
DM-20-BR	DM-20-BR-B		M20 x 1.5	.37 (9.5)	.87 (22)	.26 (6.5)	.37 (9.5)	.94 (24)	.26 (6.5)
DM-25-BR	DM-25-BR-B		M25 x 1.5	.43 (11)	1.10 (28)	.28 (7)	.43 (11)	1.10 (28)	.28 (7)
DM-32-BR	DM-32-BR-B		M32 x 1.5	.47 (12)	1.38 (35)	.31 (8)	.49 (12.5)	1.38 (35)	.31 (8)
DM-40-BR	DM-40-BR-B		M40 x 1.5	.51 (13)	1.73 (44)	.33 (8.5)	.47 (12)	1.77 (45)	.31 (8)
DM-50-BR	DM-50-BR-B		M50 x 1.5	.59 (15)	2.13 (54)	.35 (9)	.59 (15)	2.17 (55)	.35 (9)
DM-63-BR	DM-63-BR-B		M63 x 1.5	.63 (16)	2.64 (67)	.39 (10)	.63 (16)	2.68 (68)	.39 (10)

Dome Plugs: Nickel Plated Brass

Dome Plugs: Nickel Plated Brass							
Part Numbers		Thread Type & Size	Dimensions Inches (mm)				
-40°F to 176°F (-40°C to 80°C)			H	TL	D	TL	
		See page 56 for thread specs	Overall Height	Thread Length	Outer Diameter	Thread Length w/ O-Ring	
DP-07-BR	DP-07-BR-B		PG 7	.31 (8)	.20 (5)	.55 (14)	.19 (4.8)
DP-09-BR	DP-09-BR-B		PG 9	.35 (9)	.24 (6)	.67 (17)	.22 (5.5)
DP-11-BR	DP-11-BR-B		PG 11	.35 (9)	.24 (6)	.79 (20)	.22 (5.5)
DP-13-BR	DP-13-BR-B		PG 13 / 13.5	.37 (9.5)	.26 (6.5)	.87 (22)	.24 (6)
DP-16-BR	DP-16-BR-B		PG 16	.37 (9.5)	.26 (6.5)	.94 (24)	.24 (6)
DP-21-BR	DP-21-BR-B		PG 21	.43 (11)	.28 (7)	1.18 (30)	.26 (6.5)
DP-29-BR	DP-29-BR-B		PG 29	.47 (12)	.31 (8)	1.54 (39)	.30 (7.5)
DP-36-BR	DP-36-BR-B		PG 36	.59 (15)	.35 (9)	1.97 (50)	.35 (9)
DP-42-BR	DP-42-BR-B		PG 42	.63 (16)	.39 (10)	2.24 (57)	.39 (10)
DP-48-BR	DP-48-BR-B		PG 48	.63 (16)	.39 (10)	2.52 (64)	.39 (10)

To order a hole plug with an FKM O-Ring instead of Buna-N, replace "-V" (FKM) to part number (e.g. DP-11-BR-V).



Hex Plugs: Polypropylene					
Part Numbers		Thread Type & Size	Dimensions Inches (mm)		
32°F to 275°F (0°C to 135°C)			B	D	TL
		See page 56 for thread specs	Overall Height	Wrench Flat	Thread Length
HN-38-BK	3/8" NPT		.83 (21)	.75 (19)	.59 (15)
HN-12-BK	1/2" NPT		.81 (20.5)	.94 (24)	.55 (14)
HN-34-BK	3/4" NPT		.87 (22)	1.10 (28)	.63 (16)
HN-10-BK	1" NPT		.91 (23)	1.34 (34)	.67 (17)

For Material Specifications and Approval Information refer to page 52. O-Ring needed for Type Nema 4x



Elongated Thread Available Upon Request

Hex Plugs: Nickel Plated Brass			Thread Type & Size	Dimensions Inches (mm)			
Part Numbers				H	F	TL	
-4°F to 203°F (-20°C to 95°C)	-4°F to 356°F (-20°C to 180°C)	-4°F to 356°F (-20°C to 180°C)		Overall Height	Wrench Flat	Thread Length	
			See page 56 for thread specs				
without O-Ring	w/ Buna-N O-Ring	w/ FKM O-Ring					
HP-07-BR	HP-07-BR-B	HP-07-BR-V		PG 7 / 1/4" NPT	.31 (8)	.55 (14)	.20 (5)
HP-09-BR	HP-09-BR-B	HP-09-BR-V		PG 9	.35 (9)	.67 (17)	.24 (6)
HP-11-BR	HP-11-BR-B	HP-11-BR-V		PG 11	.37 (9.5)	.79 (20)	.24 (6)
HP-13-BR	HP-13-BR-B	HP-13-BR-V		PG 13 / 13.5	.39 (10)	.87 (22)	.26 (6.5)
HP-16-BR	HP-16-BR-B	HP-16-BR-V		PG 16	.39 (10)	.94 (24)	.26 (6.5)
HP-21-BR	HP-21-BR-B	HP-21-BR-V		PG 21	.41 (10.5)	1.18 (30)	.28 (7)
HP-29-BR	HP-29-BR-B	HP-29-BR-V		PG 29	.49 (12.5)	1.61 (41)	.31 (8)
HP-36-BR	HP-36-BR-B	HP-36-BR-V		PG 36	.51 (13)	1.97 (50)	.31 (8)
HP-42-BR	HP-42-BR-B	HP-42-BR-V		PG 42	.59 (15)	2.28 (58)	.35 (9)
HP-48-BR	HP-48-BR-B	HP-48-BR-V		PG 48	.65 (16.5)	2.56 (65)	.39 (10)
HM-12-BR	HM-12-BR-B	HM-12-BR-V		M12 x 1.5	.37 (9.5)	.55 (14)	.26 (6.5)
HM-16-BR	HM-16-BR-B	HM-16-BR-V		M16 x 1.5	.35 (9)	.75 (19)	.24 (6)
HM-20-BR	HM-20-BR-B	HM-20-BR-V		M20 x 1.5	.37 (9.5)	.87 (22)	.24 (6)
HM-25-BR	HM-25-BR-B	HM-25-BR-V	M25 x 1.5	.41 (10.5)	1.18 (30)	.28 (7)	
HM-32-BR	HM-32-BR-B	HM-32-BR-V	M32 x 1.5	.49 (12.5)	1.61 (41)	.31 (8)	
HM-40-BR	HM-40-BR-B	HM-40-BR-V	M40 x 1.5	.51 (13)	1.81 (46)	.31 (8)	
HM-50-BR	HM-50-BR-B	HM-50-BR-V	M50 x 1.5	.59 (15)	2.17 (55)	.35 (9)	
HM-63-BR	HM-63-BR-B	HM-63-BR-V	M63 x 1.5	.65 (16.5)	2.76 (70)	.39 (10)	



O-Ring needed for Type NEMA 4x & 6 Rating.

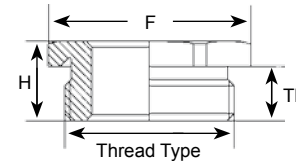

Also, all Nickel Plated Brass & Stainless Steel HM (Hex) Hole Plugs are available with Ex-d approval!

Hex Plugs also available with the following approvals:



ATEX

www.SealconEX.com

Accessories - (Hex) Hole Plugs (303) Stainless Steel - PG & Metric Threads

Hex Plugs: (303) Stainless Steel - IP 68			Thread Type & Size	Dimensions Inches (mm)			
Part Numbers				H	F	TL	
-4°F to 203°F (-20°C to 95°C)	-4°F to 356°F (-20°C to 180°C)	-76°F to 356°F (-60°C to 180°C)		Overall Height	Wrench Flat	Thread Length	
			See page 56 for thread specs				
w/ Buna-N O-Ring	w/ FKM O-Ring	w/ Silicone O-Ring					
HP-07-SS-B	HP-07-SS-V	HP-07-SS-S		PG 7 / 1/4" NPT	.31 (8)	.55 (14)	.20 (5)
HP-09-SS-B	HP-09-SS-V	HP-09-SS-S		PG 9	.35 (9)	.67 (17)	.24 (6)
HP-11-SS-B	HP-11-SS-V	HP-11-SS-S		PG 11	.37 (9.5)	.79 (20)	.24 (6)
HP-13-SS-B	HP-13-SS-V	HP-13-SS-S		PG 13 / 13.5	.39 (10)	.87 (22)	.26 (6.5)
HP-16-SS-B	HP-16-SS-V	HP-16-SS-S		PG 16	.39 (10)	.94 (24)	.26 (6.5)
HP-21-SS-B	HP-21-SS-V	HP-21-SS-S		PG 21	.41 (10.5)	1.18 (30)	.28 (7)
HP-29-SS-B	HP-29-SS-V	HP-29-SS-S		PG 29	.49 (12.5)	1.61 (41)	.31 (8)
HP-36-SS-B	HP-36-SS-V	HP-36-SS-S		PG 36	.51 (13)	1.97 (50)	.31 (8)
HM-12-SS-B	HM-12-SS-V	HM-12-SS-S		M12 x 1.5	.37 (9.5)	.55 (14)	.26 (6.5)
HM-16-SS-B	HM-16-SS-V	HM-16-SS-S		M16 x 1.5	.35 (9)	.75 (19)	.24 (6)
HM-20-SS-B	HM-20-SS-V	HM-20-SS-S		M20 x 1.5	.37 (9.5)	.87 (22)	.24 (6)
HM-25-SS-B	HM-25-SS-V	HM-25-SS-S		M25 x 1.5	.41 (10.5)	1.18 (30)	.28 (7)
HM-32-SS-B	HM-32-SS-V	HM-32-SS-S		M32 x 1.5	.49 (12.5)	1.61 (41)	.31 (8)
HM-40-SS-B	HM-40-SS-V	HM-40-SS-S	M40 x 1.5	.51 (13)	1.81 (46)	.31 (8)	



These Plugs are designed to fit and seal European PG threads per DIN 46320-FS/PA and Metric threads per DIN 46320/Ms.

They are made of Stainless Steel and are available with Buna-N, FKM or Silicone O-Ring. Also available in Nylon, Nickel Plated Brass, or 316L Stainless Steel. (Elongated Available Upon Request).

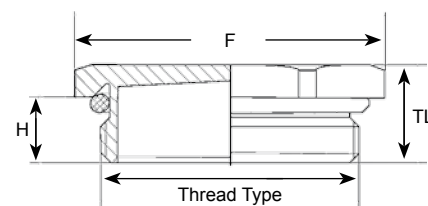

Hex Plugs also available with the following approvals:



ATEX

www.SealconEX.com



Optional Locking Nuts, O-Rings & Other Accessories starting on Page 29 - 40.

For Material Specifications and Approval Information refer to page 52.

Accessories - Cable Clamp Fitting (Low Profile) Fits Metric Threads



Accessories

Part Numbers	Cable Range	Thread Type & Size	Dimensions in Inches (mm)			
			D	B	TL	F
-140°F to 392°F (-60°C to 200°C)			Hole O.D.	Body Length	Thread Length	Wrench Flat
 Nickel Plated Brass	Inches (mm)	See page 56 for thread specs				
KL12MA-BR	.20 - .30 (5 - 7.5)	M12 x 1.5	.47 (12)	.59 (15)	.22 (5.5)	.63 (16)
KL16MA-BR	.28 - .39 (7 - 10)	M16 x 1.5	.63 (16)	.63 (16)	.24 (6)	.75 (19)
KL20MA-BR	.39 - .55 (10 - 14)	M20 x 1.5	.79 (20)	.71 (18)	.26 (6.5)	.94 (24)
KL25MA-BR	.47 - .85 (12 - 21.5)	M25 x 1.5	.98 (25)	.83 (21)	.31 (8)	1.34 (34)
KL32MA-BR	.63 - 1.06 (16-27)	M32 x 1.5	1.26 (32)	.87 (22)	.31 (8)	1.65 (42)
KL40MA-BR	.87 - 1.30 (22-33)	M40 x 1.5	1.57 (40)	1.00 (25.5)	.37 (9.5)	2.05 (52)

RoHS

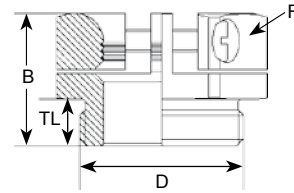

This clamp offers **Extra Pull-out Resistance**. Made of durable Nickel Plated Brass, it offers an excellent solution for your specific application needs. Not a liquid tight solution.

Also available in PG Threads!

Accessories - Deep Socket Wrenches for Strain Relief Fittings

Part Numbers	Used with Sizes		Dimensions in Inches (mm)			
	Nylon Dome Nut	Brass Dome Nut	F	L	d	D
 Socket Wrench	See page 56 for thread specs	See page 56 for thread specs	Wrench Flat	Length	Inner Diameter	Outer Diameter
S-1400-WR	-	PG7, M12	.55 (14)	2.36 (60)	.35 (9)	.75 (19)
S-1500-WR	PG7, M12	-	.59 (15)	2.36 (60)	.37 (9.5)	.79 (20)
S-1700-WR	-	PG 9, 3/8" NPT, M16	.67 (17)	2.36 (60)	.39 (10)	.93 (23.5)
S-1900-WR	PG 9, 3/8" NPT, M16	3/8" NPT, M16	.75 (19)	2.36 (60)	.43 (11)	1.02 (26)
S-2000-WR	-	PG 11, M16-E	.79 (20)	2.36 (60)	.47 (12)	1.06 (27)
S-2200-WR	PG 11, 3/8" NPT, M16-E	PG 13 / 13.5, 1/2" NPT, M20	.87 (22)	2.36 (60)	.51 (13)	1.16 (29.5)
S-2400-WR	PG 13 / 13.5, 1/2" NPT, M20	PG 16, 1/2" NPT-E, M20-E	.94 (24)	2.36 (60)	.59 (15)	1.28 (32.5)
S-2700-WR	PG 16, 1/2" NPT-E, M20-E	-	1.06 (27)	2.36 (60)	.67 (17)	1.40 (35.5)
S-3000-WR	-	PG 21, 3/4" NPT, M25	1.18 (30)	2.36 (60)	.71 (18)	1.59 (40.5)
S-3300-WR	PG 21, 3/4" NPT, M25	-	1.30 (33)	2.36 (60)	.79 (20)	1.71 (43.5)
S-4000-WR	-	PG 29, 1" NPT, M32	1.57 (40)	3.94 (100)	.98 (25)	2.07 (52.5)
S-4100-WR	PG 29	-	1.61 (41)	3.94 (100)	1.06 (27)	2.11 (53.5)
S-4200-WR	PG 29, 1", 1-1/4" NPT, M32	-	1.65 (42)	3.94 (100)	1.06 (27)	2.15 (54.5)
S-4600-WR	1-1/4" NPT	-	1.81 (46)	3.94 (100)	1.22 (31)	2.36 (60)
S-5000-WR	-	PG 36, M40	1.97 (50)	3.94 (100)	1.26 (32)	2.58 (65.5)
S-5300-WR	PG 36, 1-1/2" NPT, M40	-	2.09 (53)	3.94 (100)	1.26 (32)	2.82 (71.5)
S-5500-WR	M 50	M 50	2.17 (55)	3.94 (100)	1.26 (32)	2.83 (72)
S-5700-WR	-	PG 42, M50	2.24 (57)	3.94 (100)	1.42 (36)	2.97 (75.5)
S-6000-WR	PG 42, M50	-	2.36 (60)	3.94 (100)	1.50 (38)	3.09 (78.5)
S-6400-WR	-	PG 48, M63	2.52 (64)	3.94 (100)	1.57 (40)	3.31 (84)
S-6500-WR	PG 48, M63	-	2.56 (65)	3.94 (100)	1.65 (42)	3.35 (85)
S-6800-WR	M63	M63	2.68 (68)	3.94 (100)	1.65 (42)	3.43 (87)

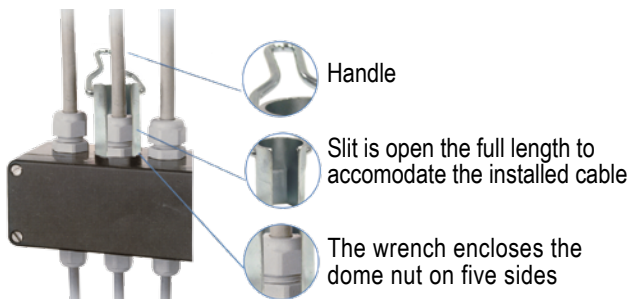

The handy, lightweight **Deep Socket Wrench** is manufactured from alloy steel. It is slit open along the full length to accommodate the installed cable during tightening of the dome nut. The wrench encloses the dome nut on five sides, giving the nut additional rigidity during tightening. This is especially important if a stiff cable is used. Does not work with all Flex Fittings.



For Material Specifications and Approval Information refer to page 52.

Dealing with foreign products?
Is connecting a challenge?
Well, look no further!

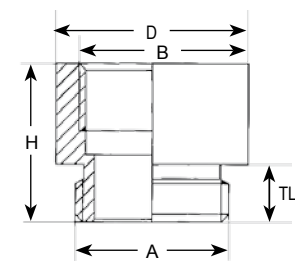

(AF-xxxx-BR & AP-xxxx-BR)

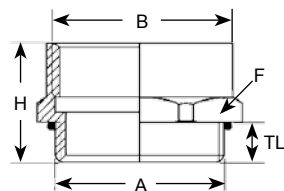

(AG-xxxx-BR & AM-xxxx-BR)

More custom parts available online
at www.SealconUSA.com
or upon request!

Operating Temperature: -40°F to 212°F (-40°C to 100°C)
(Nickel Plated Brass Adapters with O-Ring):

Thread Adapters: NPT to PG Threads*					
Part Numbers	Threads		Dimensions in Inches (mm)		
	Male Thread A	Female Thread B	F	TL	H
			Wrench Flat	Thread Length	Height
AN-1407-BR	1/4" NPT	PG 7	.75 (19)	.59 (15)	.98 (25)
AN-1209-BR	1/2" NPT	PG 9	.98 (25)	.79 (20)	1.18 (30)
AN-1211-BR	1/2" NPT	PG 11	.98 (25)	.79 (20)	1.18 (30)
AN-1213-BR	1/2" NPT	PG 13/13.5	.98 (25)	.79 (20)	1.18 (30)
AN-1221-BR	1/2" NPT	PG 21	1.30 (33)	.79 (20)	1.26 (32)
AN-3421-BR	3/4" NPT	PG 21	1.30 (33)	.67 (17)	1.22 (31)
AN-1029-BR	1" NPT	PG 29	1.61 (41)	.98 (25)	1.57 (40)

*O-Ring not included

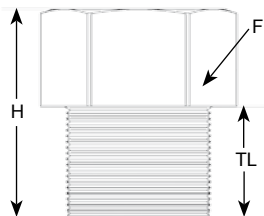

(AN-xxxx-BR)

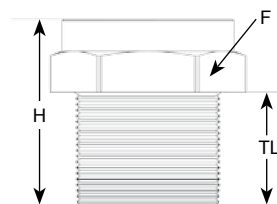

(AT-xxxx-BR)

Thread Adapters: NPT to Metric Threads*					
Part Numbers	Threads		Dimensions in Inches (mm)		
	Male Thread A	Female Thread B	F	TL	H
			Wrench Flat	Thread Length	Height
AT-1216-BR	1/2" NPT	M16 x 1.5	.98 (25)	.79 (20)	1.18 (30)
AT-1220-BR	1/2" NPT	M20 x 1.5	.98 (25)	.79 (20)	1.18 (30)
AT-1225-BR	1/2" NPT	M25 x 1.5	1.26 (32)	.79 (20)	1.18 (30)
AT-3425-BR	3/4" NPT	M25 x 1.5	1.24 (31.6)	.75 (19)	1.18 (30)
AT-1032-BR	1" NPT	M32 x 1.5	1.50 (38)	.98 (25)	1.61 (41)
AT-5432-BR	1-1/4" NPT	M32 x 1.5	1.67 (42.5)	.59 (15)	1.30 (33)

*O-Ring not included.

See page 56 for thread specifications.

Thread Adapters: PG to NPT Threads					
Part Numbers	Threads		Dimensions in Inches (mm)		
	Male Thread A	Female Thread B	F	TL	H
			Wrench Flat	Thread Length	Height
AG-0912-BR*	PG 9	1/2" NPT	.94 (24)	.24 (6)	.94 (24)
AG-1112-BR	PG 11	1/2" NPT	.94 (24)	.24 (6)	.89 (22.7)
AG-1312-BR	PG 13/13.5	1/2" NPT	.94 (24)	.26 (6.5)	.93 (23.5)
AG-1612-BR	PG 16	1/2" NPT	.94 (24)	.26 (6.5)	.91 (23)
AG-2112-BR	PG 21	1/2" NPT	1.18 (30)	.28 (7)	.59 (15)
AG-2134-BR	PG 21	3/4" NPT	1.18 (30)	.28 (7)	.94 (24)
AG-2910-BR	PG 29	1" NPT	1.57 (40)	.31 (8)	.79 (20)

Thread Adapters: PG to Metric Threads*					
Part Numbers	Threads		Dimensions in Inches (mm)		
	Male Thread A	Female Thread B	D	TL	H
			Outer Diameter	Thread Length	Height
AP-0916-BR	PG 9	M16 x 1.5	.79 (20)	.24 (6)	.65 (16.5)
AP-1120-BR	PG 11	M20 x 1.5	.87 (22)	.26 (6.5)	.75 (19)
AP-1320-BR	PG 13/13.5	M20 x 1.5	.87 (22)	.26 (6.5)	.75 (19)
AP-1625-BR	PG 16	M25 x 1.5	1.06 (27)	.26 (6.5)	.83 (21)

Thread Adapters: Metric to PG Threads*					
Part Numbers	Threads		Dimensions in Inches (mm)		
	Male Thread A	Female Thread B	D	TL	H
			Outer Diameter	Thread Length	Height
AF-1609-BR	M16 x 1.5	PG 9	.79 (20)	.24 (6)	.65 (16.5)
AF-2011-BR	M20 x 1.5	PG 11	.87 (22)	.26 (6.5)	.75 (19)
AF-2013-BR	M20 x 1.5	PG 13/13.5	.87 (22)	.26 (6.5)	.75 (19)
AF-2016-BR	M20 x 1.5	PG 16	.94 (24)	.26 (6.5)	.75 (19)
AF-2516-BR	M25 x 1.5	PG 16	1.10 (28)	.26 (6.5)	.75 (19)
AF-2521-BR	M25 x 1.5	PG 21	1.18 (30)	.26 (6.5)	.83 (21)
AF-3229-BR	M32 x 1.5	PG 29	1.54 (39)	.28 (7)	.91 (23)

Thread Adapters: Metric to NPT Threads					
Part Numbers	Threads		Dimensions in Inches (mm)		
	Male Thread A	Female Thread B	F	TL	H
			Wrench Flat	Thread Length	Height
AM-1612-BR	M16 x 1.5	1/2" NPT	.94 (24)	.24 (6)	.91 (23)
AM-2012-BR	M20 x 1.5	1/2" NPT	.94 (24)	.24 (6)	.91 (23)
AM-2512-BR	M25 x 1.5	1/2" NPT	1.18 (30)	.28 (7)	.59 (15)
AM-2534-BR	M25 x 1.5	3/4" NPT	1.18 (30)	.28 (7)	1.07 (26)
AM-3210-BR	M32 x 1.5	1" NPT	1.57 (40)	.31 (8)	1.30 (33)
AM-3254-BR	M32 x 1.5	1-1/4" NPT	1.81 (46)	.31 (8)	1.30 (33)

RoHS



Type A

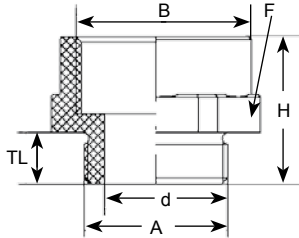

Type B

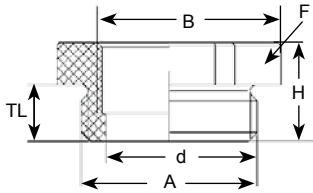

Type C

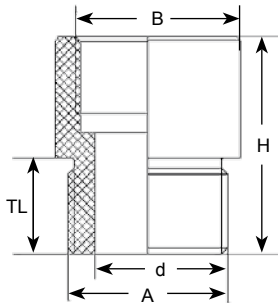

Type D

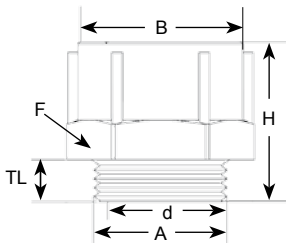

Type E

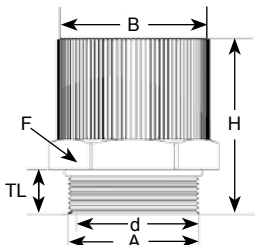

Operating Temperature: -4°F to 176°F (-20°C to 80°C)
(Metric to PG & PG to Metric Nylon Adapters)

Black Nylon/Polypropylene* - Thread Adapters: Metric to PG Threads

Part Numbers	Threads		Adapter Type	Dimensions in Inches (mm)			
	Male Thread A	Female Thread B		TL	H	d	F
				Thread Length	Height	Inner Diameter	Wrench Flat
AF-1207-BK	M12 x 1.5	PG 7	A	.31 (8)	.79 (20)	.26 (6.5)	.67 (17)
AF-1609-BK	M16 x 1.5	PG 9	C*	.59 (15)	1.34 (34)	.33 (8.5)	N/A
AF-2013-BK	M20 x 1.5	PG 13	A	.31 (8)	.83 (21)	.55 (14)	.98 (25)
AF-2513-BK	M25 x 1.5	PG 13 / 13.5	B	.31 (8)	.55 (14)	.71 (18)	1.14 (29)
AF-2516-BK	M25 x 1.5	PG 16	A	.31 (8)	.87 (22)	.71 (18)	1.14 (29)
AF-3221-BK	M32 x 1.5	PG 21	A	.39 (10)	.98 (25)	.98 (25)	1.43 (36)
AF-4029-BK	M40 x 1.5	PG 29	A	.39 (10)	.98 (25)	1.30 (33)	1.77 (45)
AF-5036-BK	M50 x 1.5	PG 36	A	.47 (12)	1.14 (29)	1.69 (43)	2.17 (55)
AF-6342-BK	M63 x 1.5	PG 42	C	.59 (15)	.79 (20)	2.05 (52)	N/A
AF-6348-BK	M63 x 1.5	PG 48	C*	.59 (15)	1.38 (35)	2.01 (51)	N/A

*Parts are made of Polypropylene.

Black Nylon/Polypropylene* - Thread Adapters: PG to Metric Threads

Part Numbers	Threads		Adapter Type	Dimensions in Inches (mm)			
	Male Thread A	Female Thread B		TL	H	d	F
				Thread Length	Height	Inner Diameter	Wrench Flat
AP-0712-BK	PG 7	M12 x 1.5	C*	.59 (15)	1.34 (34)	.24 (6)	N/A
AP-0912-BK	PG 9	M12 x 1.5	C	.59 (15)	1.34 (34)	.33 (8.5)	N/A
AP-0916-BK	PG 9	M16 x 1.5	A	.31 (8)	.79 (20)	.35 (9)	.83 (21)
AP-1116-BK	PG 11	M16 x 1.5	C	.59 (15)	1.34 (34)	.45 (11.5)	N/A
AP-1120-BK	PG 11	M20 x 1.5	C*	.59 (15)	1.34 (34)	.45 (11.5)	N/A
AP-1316-BK	PG 13 / 13.5	M16 x 1.5	B	.31 (8)	.55 (14)	.55 (14)	.98 (25)
AP-1320-BK	PG 13	M20 x 1.5	A	.31 (8)	.83 (21)	.55 (14)	.98 (25)
AP-1620-BK	PG 16	M20 x 1.5	A	.31 (8)	.83 (21)	.63 (16)	1.06 (27)
AP-1625-BK	PG 16	M25 x 1.5	A	.31 (8)	.91 (23)	.63 (16)	1.18 (30)
AP-2125-BK	PG 21	M25 x 1.5	C	.59 (15)	1.34 (34)	.81 (20.5)	N/A
AP-2132-BK	PG 21	M32 x 1.5	A	.31 (8)	.91 (23)	.83 (21)	1.46 (37)
AP-2932-BK	PG 29	M32 x 1.5	C	.59 (15)	1.34 (34)	1.10 (28)	N/A
AP-2940-BK	PG 29	M40 x 1.5	A	.39 (10)	1.06 (27)	1.18 (30)	1.77 (45)
AP-3640-BK	PG 36	M40 x 1.5	C	.59 (15)	.79 (20)	1.50 (38)	N/A
AP-3650-BK	PG 36	M50 x 1.5	C*	.59 (15)	1.36 (34.5)	1.46 (37)	N/A
AP-4240-BK	PG 42	M40 x 1.5	C	.59 (15)	.79 (20)	1.50 (38)	N/A
AP-4250-BK	PG 42	M50 x 1.5	C*	.59 (15)	1.36 (34.5)	1.69 (43)	N/A
AP-4850-BK	PG 48	M50 x 1.5	C	.59 (15)	.79 (20)	1.50 (38)	N/A
AP-4863-BK	PG 48	M63 x 1.5	C*	.59 (15)	1.38 (35)	1.89 (48)	N/A

Black Nylon - Thread Adapters: PG to NPT Threads

Part Numbers	Threads		Adapter Type	Dimensions in Inches (mm)			
	Male Thread A	Female Thread B		TL	H	d	F
				Thread Length	Height	Inner Diameter	Wrench Flat
AG-1112-BK	PG 11	1/2" NPT	D	.28 (7)	.83 (21)	N/A	.94 (24)
AG-1312-BK	PG 13 / 13.5	1/2" NPT	D	.35 (9)	.91 (23)	N/A	.94 (24)

Black Nylon - Thread Adapters: Metric to NPT Threads

Part Numbers	Threads		Adapter Type	Dimensions in Inches (mm)			
	Male Thread A	Female Thread B		TL	H	d	F
				Thread Length	Height	Inner Diameter	Wrench Flat
AM-1612-BK	M16 x 1.5	1/2" NPT	E	.28 (7)	1.10 (28)	N/A	1.02 (26)
AM-2012-BK	M20 x 1.5	1/2" NPT	E	.28 (7)	1.06 (27)	N/A	1.02 (26)

Is your thread size off by one size?

These Reducers will solve that threading problem. They convert holes which fit PG, NPT or Metric threads to a smaller female thread of the same thread type.



Operating Temperature:

-40°C to 100°C (-40°F to 212°F)

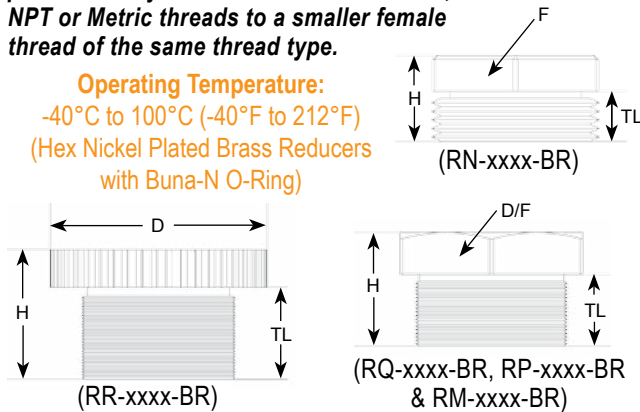
(Hex Nickel Plated Brass Reducers with Buna-N O-Ring)



Thread Reducers: PG to PG Threads

Part Numbers		Threads		Dimensions in Inches (mm)		
		Male Thread A	Female Thread B	F	TL	H
				Wrench Flat	Thread Length	Height
RQ-0907-BR	RP-0907-BR	PG 9	PG 7	.67 (17)	.24 (6)	.34 (8.8)
RQ-1107-BR	RP-1107-BR	PG 11	PG 7	.79 (20)	.24 (6)	.35 (9)
RQ-1109-BR	RP-1109-BR	PG 11	PG 9	.79 (20)	.24 (6)	.35 (9)
RQ-1309-BR	RP-1309-BR	PG 13/13.5	PG 9	.87 (22)	.26 (6.5)	.37 (9.5)
RQ-1311-BR	RP-1311-BR	PG 13/13.5	PG 11	.87 (22)	.26 (6.5)	.37 (9.5)
RQ-1609-BR	RP-1609-BR	PG 16	PG 9	.94 (24)	.26 (6.5)	.37 (9.5)
RQ-1611-BR	RP-1611-BR	PG 16	PG 11	.94 (24)	.26 (6.5)	.37 (9.5)
RQ-1613-BR	RP-1613-BR	PG 16	PG 13/13.5	.94 (24)	.26 (6.5)	.37 (9.5)
RQ-2111-BR	RP-2111-BR	PG 21	PG 11	1.18 (30)	.28 (7)	.41 (10.3)
RQ-2113-BR	RP-2113-BR	PG 21	PG 13/13.5	1.18 (30)	.28 (7)	.41 (10.3)
RQ-2116-BR	RP-2116-BR	PG 21	PG 16	1.18 (30)	.28 (7)	.41 (10.3)
RQ-2916-BR	RP-2916-BR	PG 29	PG 16	1.57 (40)	.31 (8)	.45 (11.5)
RQ-2921-BR	RP-2921-BR	PG 29	PG 21	1.57 (40)	.31 (8)	.45 (11.5)
RQ-3621-BR	RP-3621-BR	PG 36	PG 21	1.97 (50)	.35 (9)	.49 (12.5)
RQ-3629-BR	RP-3629-BR	PG 36	PG 29	1.97 (50)	.35 (9)	.49 (12.5)
RQ-4229-BR	RP-4229-BR	PG 42	PG 29	2.24 (57)	.39 (10)	.53 (13.5)
RQ-4236-BR	RP-4236-BR	PG 42	PG 36	2.24 (57)	.39 (10)	.53 (13.5)
RQ-4836-BR	RP-4836-BR	PG 48	PG 36	2.52 (64)	.39 (10)	.53 (13.5)
RQ-4842-BR	RP-4842-BR	PG 48	PG 42	2.52 (64)	.39 (10)	.53 (13.5)

Thread Reducers: Metric to Metric Threads*

	Threads		Dimensions in Inches (mm)		
	Male Thread A	Female Thread B	D Outer Diameter	TL Thread Length	H Height
RR-1612-BR	M16 x 1.5	M12 x 1.5	.71 (18)	.24 (6)	.33 (8.5)
RR-2012-BR	M20 x 1.5	M12 x 1.5	.94 (24)	.26 (6.5)	.35 (9)
RR-2016-BR	M20 x 1.5	M16 x 1.5	.94 (24)	.26 (6.5)	.35 (9)
RR-2516-BR	M25 x 1.5	M16 x 1.5	1.18 (30)	.28 (7)	.39 (10)
RR-2520-BR	M25 x 1.5	M20 x 1.5	1.18 (30)	.28 (7)	.39 (10)
RR-3220-BR	M32 x 1.5	M20 x 1.5	1.54 (39)	.31 (8)	.45 (11.5)
RR-3225-BR	M32 x 1.5	M25 x 1.5	1.54 (39)	.31 (8)	.45 (11.5)
RR-4025-BR	M40 x 1.5	M25 x 1.5	1.69 (43)	.31 (8)	.45 (11.5)
RR-4032-BR	M40 x 1.5	M32 x 1.5	1.69 (43)	.35 (9)	.49 (12.5)
RR-5032-BR	M50 x 1.5	M32 x 1.5	2.24 (57)	.39 (10)	.55 (14)
RR-5040-BR	M50 x 1.5	M40 x 1.5	2.24 (57)	.39 (10)	.55 (14)
RR-6340-BR	M63 x 1.5	M40 x 1.5	2.52 (64)	.39 (10)	.55 (14)
RR-6350-BR	M63 x 1.5	M50 x 1.5	2.52 (64)	.39 (10)	.55 (14)

Reducers are also available with the following approvals:



www.SealconEX.com

Thread Reducers: Metric to Metric Threads

	Threads		Dimensions in Inches (mm)		
	Male Thread A	Female Thread B	F Wrench Flat	TL Thread Length	H Height
RM-1612-BR	M16 x 1.5	M12 x 1.5	.67 (17)	.20 (5)	.31 (8)
RM-2012-BR	M20 x 1.5	M12 x 1.5	.87 (22)	.24 (6)	.35 (9)
RM-2016-BR	M20 x 1.5	M16 x 1.5	.87 (22)	.24 (6)	.35 (9)
RM-2516-BR	M25 x 1.5	M16 x 1.5	1.06 (27)	.28 (7)	.39 (10)
RM-2520-BR	M25 x 1.5	M20 x 1.5	1.06 (27)	.28 (7)	.39 (10)
RM-3216-BR	M32 x 1.5	M16 x 1.5	1.34 (34)	.31 (8)	.43 (11)
RM-3220-BR	M32 x 1.5	M20 x 1.5	1.34 (34)	.31 (8)	.43 (11)
RM-3225-BR	M32 x 1.5	M25 x 1.5	1.34 (34)	.31 (8)	.43 (11)
RM-4020-BR	M40 x 1.5	M20 x 1.5	1.46 (43)	.31 (8)	.47 (12)
RM-4025-BR	M40 x 1.5	M25 x 1.5	1.46 (43)	.31 (8)	.47 (12)
RM-4032-BR	M40 x 1.5	M32 x 1.5	1.46 (43)	.31 (8)	.47 (12)
RM-5025-BR	M50 x 1.5	M25 x 1.5	2.17 (55)	.35 (9)	.51 (13)
RM-5032-BR	M50 x 1.5	M32 x 1.5	2.17 (55)	.35 (9)	.51 (13)
RM-5040-BR	M50 x 1.5	M40 x 1.5	2.17 (55)	.35 (9)	.51 (13)
RM-6332-BR	M63 x 1.5	M32 x 1.5	2.56 (65)	.39 (10)	.55 (14)
RM-6340-BR	M63 x 1.5	M40 x 1.5	2.56 (65)	.39 (10)	.55 (14)
RM-6350-BR	M63 x 1.5	M50 x 1.5	2.56 (65)	.39 (10)	.55 (14)

*German Lloyd Approval applies to Hex Reducers

Thread Reducers: NPT to NPT Threads

	Threads		Dimensions in Inches (mm)		
	Male Thread A	Female Thread B	F Wrench Flat	TL Thread Length	H Height
RN-3412-BR*	3/4" NPT	1/2" NPT	1.18 (30)	.71 (18)	.87 (22)
RN-1034-BR*	1" NPT	3/4" NPT	1.30 (33)	.98 (25)	1.14 (29)
RN-5410-BR*	1-1/4" NPT	1" NPT	1.69 (43)	.98 (25)	1.14 (29)

See page 56 for thread specifications.

RoHS

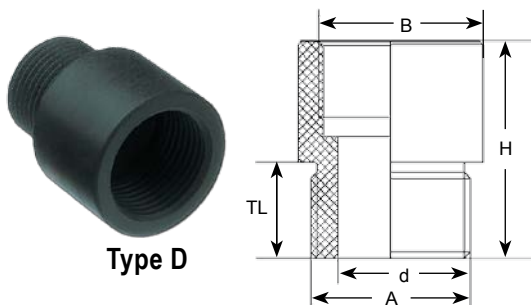
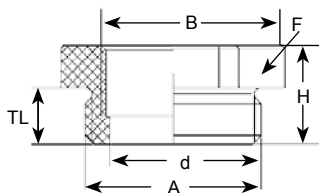
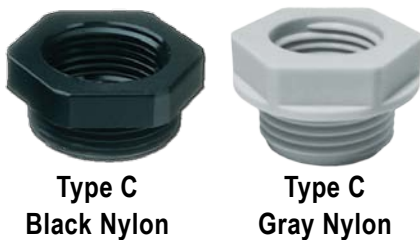
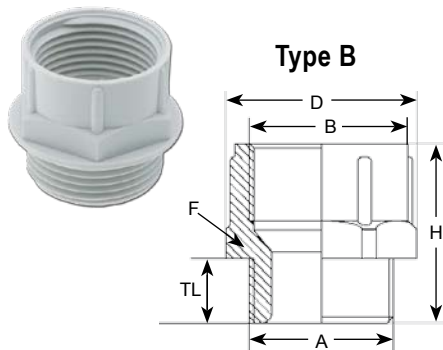
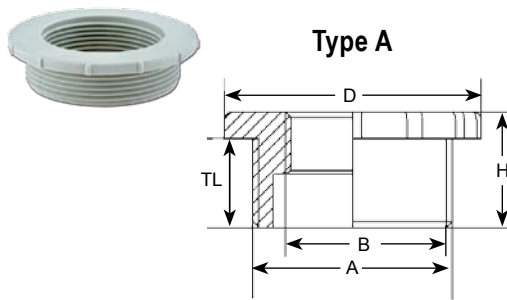

Gray Nylon - Thread Reducers: PG to PG Threads*

Part Numbers	Threads		Adapter Type	Dimensions in Inches (mm)			
	Male Thread A	Female Thread B		TL	H	D	F
				Thread Length	Height	Outer Diameter	Wrench Flat
-40°F to 176°F (-40°C to 80°C)							
RR-0907-GY	PG 9	PG 7	B	.31 (8)	.55 (14)	.75 (19)	.59 (15)
RR-1109-GY	PG 11	PG 9	B	.31 (8)	.71 (18)	.89 (22.5)	.75 (19)
RR-1309-GY	PG 13/13.5	PG 9	A	.31 (8)	.47 (12)	1.06 (27)	N/A
RR-1311-GY	PG 13/13.5	PG 11	B	.35 (9)	.83 (21)	1.0 (25.5)	.87 (22)
RR-1609-GY	PG 16	PG 9	A	.39 (10)	.51 (13)	1.14 (29)	N/A
RR-1611-GY	PG 16	PG11	A	.39 (10)	.51 (13)	1.14 (29)	N/A
RR-1613-GY	PG 16	PG 13/13.5	B	.39 (10)	.98 (25)	1.13 (28.5)	.94 (24)
RR-2113-GY	PG 21	PG 13/13.5	A	.43 (11)	.53 (13.5)	1.42 (36)	N/A
RR-2116-GY	PG 21	PG 16	A	.43 (11)	.53 (13.5)	1.42 (36)	N/A
RR-2921-GY	PG 29	PG 21	A	.43 (11)	.53 (13.5)	1.81 (46)	N/A
RR-3629-GY	PG 36	PG 29	A	.43 (11)	.59 (15)	2.28 (58)	N/A

Gray Nylon - Thread Reducers: Metric to Metric Threads*

Part Numbers	Threads		Adapter Type	Dimensions in Inches (mm)			
	Male Thread A	Female Thread B		TL	H	D	F
				Thread Length	Height	Outer Diameter	Wrench Flat
-40°F to 176°F (-40°C to 80°C)							
RR-1612-GY	M16 x 1.5	M12 x 1.5	C	.35 (9)	.63 (16)	.94 (24)	.87 (22)
RR-2016-GY	M20 x 1.5	M16 x 1.5	C	.35 (9)	.63 (16)	1.06 (27)	.94 (24)
RR-2520-GY	M25 x 1.5	M20 x 1.5	C	.39 (10)	.67 (17)	1.26 (32)	1.14 (29)
RR-3225-GY	M32 x 1.5	M25 x 1.5	C	.47 (12)	.75 (19)	1.57 (40)	1.42 (36)
RR-4032-GY	M40 x 1.5	M32 x 1.5	C	.47 (12)	.75 (19)	2.01 (51)	1.81 (46)
RR-5040-GY	M50 x 1.5	M40 x 1.5	C	.55 (14)	.83 (21)	2.40 (61)	2.17 (55)
RR-6350-GY	M63 x 1.5	M50 x 1.5	C	.59 (15)	.87 (22)	2.95 (75)	2.56 (65)

Black Nylon - Thread Reducers: Metric to Metric Threads*

Part Numbers	Threads		Adapter Type	Dimensions in Inches (mm)			
	Male Thread A	Female Thread B		TL	H	d	F
				Thread Length	Height	Inner Diameter	Wrench Flat
-4°F to 176°F (-20°C to 80°C)							
RM-1612-BK	M16 x 1.5	M12 x 1.5	C	.31 (8)	.24 (6)	.39 (10)	.79 (20)
RM-2016-BK	M20 x 1.5	M16 x 1.5	C	.31 (8)	.55 (14.1)	.53 (13.5)	.98 (25)
RM-2520-BK	M25 x 1.5	M20 x 1.5	C	.31 (8)	.55 (14.1)	.71 (18)	1.14 (29)
RM-3225-BK	M32 x 1.5	M25 x 1.5	C	.39 (10)	.64 (16.1)	.91 (23)	1.42 (36)
RM-4032-BK	M40 x 1.5	M32 x 1.5	D	.59 (15)	.79 (20)	1.18 (30)	N/A
RM-5040-BK	M50 x 1.5	M40 x 1.5	D	.59 (15)	.79 (20)	1.50 (38)	N/A
RM-6350-BK	M63 x 1.5	M50 x 1.5	D	.59 (15)	.79 (20)	1.89 (48)	N/A

Black Polypropylene - Thread Reducers: NPT to NPT Threads*

Part Numbers	Threads		Adapter Type	Dimensions in Inches (mm)		
	Male Thread A	Female Thread B		TL	H	d
				Thread Length	Height	Inner Diameter
-4°F to 176°F (-20°C to 80°C)						
RB-3412-02	3/4" NPT	1/2" NPT	C	.64 (16.2)	.89 (22.5)	.70 (17.7)
RB-3438-02	3/4" NPT	3/8" NPT	C	.63 (15.9)	.88 (22.2)	.70 (17.7)
RB-1012-02	1" NPT	1/2" NPT	C	.65 (16.5)	.90 (22.9)	.91 (23.1)
RB-1034-02	1" NPT	3/4" NPT	C	.65 (16.5)	.90 (22.9)	.92 (23.4)
RB-1214-02	1/2" NPT	1/4" NPT	C	.57 (14.4)	.81 (20.7)	.56 (14.2)
RB-1238-02	1/2" NPT	3/8" NPT	C	.57 (14.4)	.82 (20.9)	.56 (14.2)

*O-Ring not Included

See page 56 for thread specifications.

303 Stainless Steel Thread Reducers: Metric to Metric Threads

Part Numbers		Threads		Dimensions in Inches (mm)		
Without O-Ring	-4°F to 203°F (-20°C to 95°C) With Buna-N O-Ring	Male Thread A	Female Thread B	F	TL	H
				Wrench Flat	Thread Length	Height
RM-1612-SS	RM-1612-SS-B	M16 x 1.5	M12 x 1.5	.67 (17)	.20 (5)	.35 (9)
RM-2012-SS	RM-2012-SS-B	M20 x 1.5	M12 x 1.5	.87 (22)	.24 (6)	.37 (9.5)
RM-2016-SS	RM-2016-SS-B	M20 x 1.5	M16 x 1.5	.87 (22)	.24 (6)	.37 (9.5)
RM-2516-SS	RM-2516-SS-B	M25 x 1.5	M16 x 1.5	1.06 (27)	.28 (7)	.41 (10.5)
RM-2520-SS	RM-2520-SS-B	M25 x 1.5	M20 x 1.5	1.06 (27)	.28 (7)	.41 (10.5)
RM-3216-SS	RM-3216-SS-B	M32 x 1.5	M16 x 1.5	1.34 (34)	.31 (8)	.49 (12.5)
RM-3220-SS	RM-3220-SS-B	M32 x 1.5	M20 x 1.5	1.34 (34)	.31 (8)	.49 (12.5)
RM-3225-SS	RM-3225-SS-B	M32 x 1.5	M25 x 1.5	1.34 (34)	.31 (8)	.49 (12.5)
RM-4020-SS	RM-4020-SS-B	M40 x 1.5	M20 x 1.5	1.46 (43)	.31 (8)	.51 (13)
RM-4025-SS	RM-4025-SS-B	M40 x 1.5	M25 x 1.5	1.46 (43)	.31 (8)	.51 (13)
RM-4032-SS	RM-4032-SS-B	M40 x 1.5	M32 x 1.5	1.46 (43)	.31 (8)	.51 (13)
RM-5025-SS	RM-5025-SS-B	M50 x 1.5	M25 x 1.5	2.17 (55)	.35 (9)	.59 (15)
RM-5032-SS	RM-5032-SS-B	M50 x 1.5	M32 x 1.5	2.17 (55)	.35 (9)	.59 (15)
RM-5040-SS	RM-5040-SS-B	M50 x 1.5	M40 x 1.5	2.17 (55)	.35 (9)	.59 (15)
RM-6332-SS	RM-6332-SS-B	M63 x 1.5	M32 x 1.5	2.56 (65)	.39 (10)	.65 (16.5)
RM-6340-SS	RM-6340-SS-B	M63 x 1.5	M40 x 1.5	2.56 (65)	.39 (10)	.65 (16.5)
RM-6350-SS	RM-6350-SS-B	M63 x 1.5	M50 x 1.5	2.56 (65)	.39 (10)	.65 (16.5)

Adapter, Reducer & Enlarger Applications:

- International machine builder & equipment
 - Import / Export oriented projects
 - Adapting to domestic markets

303 Stainless Steel Thread Reducers: PG to PG Threads

Part Numbers		Threads		Dimensions in Inches (mm)		
Without O-Ring	-4°F to 203°F (-20°C to 95°C) With Buna-N O-Ring	Male Thread A	Female Thread B	F	TL	H
				Wrench Flat	Thread Length	Height
RP-0907-SS	RQ-0907-SS	PG 9	PG 7	.67 (17)	.24 (6)	.34 (8.8)
RP-1107-SS	RQ-1107-SS	PG 11	PG 7	.87 (22)	.24 (6)	.35 (9)
RP-1109-SS	RQ-1109-SS	PG 11	PG 9	.87 (22)	.24 (6)	.35 (9)
RP-1309-SS	RQ-1309-SS	PG 13/13.5	PG 9	.87 (22)	.26 (6.5)	.37 (9.5)
RP-1311-SS	RQ-1311-SS	PG 13/13.5	PG 11	.87 (22)	.26 (6.5)	.37 (9.5)
RP-1609-SS	RQ-1609-SS	PG 16	PG 9	.94 (24)	.26 (6.5)	.37 (9.5)
RP-1611-SS	RQ-1611-SS	PG 16	PG 11	.94 (24)	.26 (6.5)	.37 (9.5)
RP-1613-SS	RQ-1613-SS	PG 16	PG 13/13.5	.94 (24)	.26 (6.5)	.37 (9.5)
RP-2111-SS	RQ-2111-SS	PG 21	PG 11	1.18 (30)	.28 (7)	.41 (10.3)
RP-2113-SS	RQ-2113-SS	PG 21	PG 13/13.5	1.18 (30)	.28 (7)	.41 (10.3)
RP-2116-SS	RQ-2116-SS	PG 21	PG 16	1.18 (30)	.28 (7)	.41 (10.3)
RP-2916-SS	RQ-2916-SS	PG 29	PG 16	1.57 (40)	.31 (8)	.45 (11.5)
RP-2921-SS	RQ-2921-SS	PG 29	PG 21	1.57 (40)	.31 (8)	.45 (11.5)
RP-3621-SS	RQ-3621-SS	PG 36	PG 21	1.97 (50)	.35 (9)	.49 (12.5)
RP-3629-SS	RQ-3629-SS	PG 36	PG 29	1.97 (50)	.35 (9)	.49 (12.5)
RP-4229-SS	RQ-4229-SS	PG 42	PG 29	2.24 (57)	.39 (10)	.53 (13.5)
RP-4236-SS	RQ-4236-SS	PG 42	PG 36	2.24 (57)	.39 (10)	.53 (13.5)
RP-4836-SS	RQ-4836-SS	PG 48	PG 36	2.52 (64)	.39 (10)	.53 (13.5)
RP-4842-SS	RQ-4842-SS	PG 48	PG 42	2.52 (64)	.39 (10)	.53 (13.5)

Buna-N O-Rings can be substituted with Silicone or FKM O-Rings (see page 29).
To order, add "-S" (Silicone) or "-V" (FKM) to part number (e.g. RM-1612-SS-V).

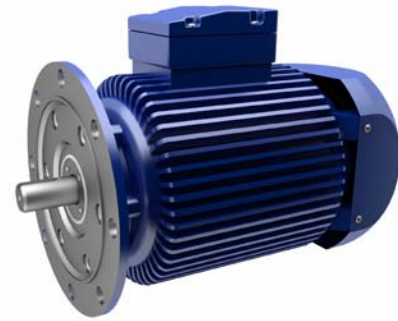

The 316L material is much harder and ideal for direct exposure to salt water and chemical solutions in marine, off-shore, pharmaceutical, etc.

316L Stainless Steel Reducers are produced upon request at a minimum order quantity.

Please allow for longer delivery times!

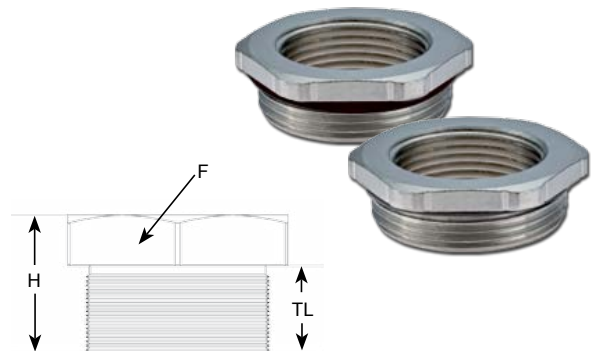

Reducers are also available with the following approvals:



www.SealconEX.com

See page 56 for thread specifications.

Black Nylon/Polypropylene - Thread Enlargers: Metric to Metric Threads

Part Numbers	Threads		Adapter Type	Dimensions in Inches (mm)			
	Male Thread A	Female Thread B		TL	H	d	F
				Thread Length	Height	Inner Diameter	Wrench Flat
EM-1216-BK	M12 x 1.5	M16 x 1.5	A	.31 (8)	.47 (12)	.26 (6.5)	.83 (21)
EM-1620-BK	M16 x 1.5	M20 x 1.5	A	.31 (8)	.51 (13)	.35 (9)	.98 (25)
EM-2025-BK	M20 x 1.5	M25 x 1.5	A	.31 (8)	.59 (15)	.55 (14)	1.18 (30)
EM-2532-BK	M25 x 1.5	M32 x 1.5	C*	.59 (15)	.59 (15)	.65 (16.5)	N/A
EM-3240-BK	M32 x 1.5	M40 x 1.5	C*	.59 (15)	.77 (19.5)	.91 (23)	N/A
EM-4050-BK	M40 x 1.5	M50 x 1.5	C*	.59 (15)	.77 (19.5)	1.18 (30)	N/A
EM-5063-BK	M50 x 1.5	M63 x 1.5	C*	.59 (15)	.79 (20)	1.54 (39)	N/A

RoHS

Black Nylon Operating Temperature: -4°F to 176°F (-20°C to 80°C)



Type A

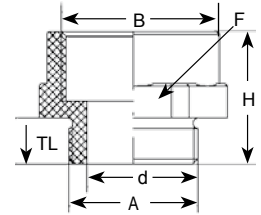

Type C

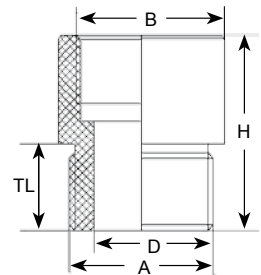

*Parts are made of Polypropylene.

Is your thread size off by one size?

These Enlargers will solve that threading problem.

They convert holes which fit PG, NPT or Metric threads to a larger female thread of the same thread type.

Nickel Plated Brass: PG to PG Threads

Part Numbers	Threads		Dimensions in Inches (mm)		
	Male Thread A	Female Thread B	D	TL	H
			Outer Diameter	Thread Length	Height
EP-0709-BR	PG 7	PG 9	.67 (17)	.20 (5)	.59 (15)
EP-0911-BR	PG 9	PG 11	.79 (20)	.24 (6)	.65 (16.5)
EP-0913-BR	PG 9	PG 13/13.5	.87 (22)	.24 (6)	.69 (17.5)
EP-1113-BR	PG 11	PG 13/13.5	.87 (22)	.24 (6)	.69 (17.5)
EP-1116-BR	PG 11	PG 16	.94 (24)	.24 (6)	.73 (18.5)
EP-1121-BR	PG 11	PG 21	1.18 (30)	.24 (6)	.81 (20.5)
EP-1316-BR	PG 13/13.5	PG 16	.94 (24)	.26 (6.5)	.75 (19)
EP-1321-BR	PG 13/13.5	PG 21	1.18 (30)	.26 (6.5)	.83 (21)
EP-1621-BR	PG 16	PG 21	1.18 (30)	.26 (6.5)	.83 (21)
EP-1629-BR	PG 16	PG 29	1.54 (39)	.26 (6.5)	.88 (22.5)
EP-2129-BR	PG 21	PG 29	1.54 (39)	.28 (7)	.91 (23)
EP-2936-BR	PG 29	PG 36	1.97 (50)	.31 (8)	1.08 (27.5)
EP-3642-BR	PG 36	PG 42	2.24 (57)	.35 (9)	1.22 (31)
EP-4248-BR	PG 42	PG 48	2.52 (64)	.39 (10)	1.30 (33)

Nickel Plated Brass: Metric to Metric Threads

Part Numbers	Threads		Dimensions in Inches (mm)		
	Male Thread A	Female Thread B	D	TL	H
			Outer Diameter	Thread Length	Height
EM-1216-BR	M12 x 1.5	M16 x 1.5	.71 (18)	.20 (5)	.59 (15)
EM-1620-BR	M16 x 1.5	M20 x 1.5	.87 (22)	.24 (6)	.69 (17.5)
EM-2025-BR	M20 x 1.5	M25 x 1.5	1.06 (27)	.26 (6.5)	.75 (19)
EM-2532-BR	M25 x 1.5	M32 x 1.5	1.34 (34)	.26 (6.5)	.83 (21)
EM-3240-BR	M32 x 1.5	M40 x 1.5	1.65 (42)	.28 (7)	.91 (23)
EM-4050-BR	M40 x 1.5	M50 x 1.5	2.09 (53)	.35 (9)	1.22 (31)
EM-5063-BR	M50 x 1.5	M63 x 1.5	2.60 (66)	.35 (9)	1.22 (31)

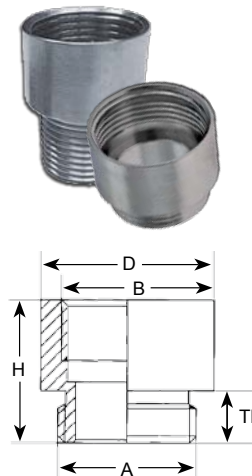

More custom parts available online at www.SealconUSA.com or upon request!

Nickel Plated Brass: NPT to NPT Threads

Part Numbers	Threads		Dimensions in Inches (mm)		
	Male Thread A	Female Thread B	D	TL	H
			Outer Diameter	Thread Length	Height
EN-3812-BR	3/8" NPT	1/2" NPT	1.10 (28)	.59 (15)	1.50 (38)
EN-1234-BR	1/2" NPT	3/4" NPT	1.10 (28)	.79 (20)	1.50 (38)
EN-1210-BR	1/2" NPT	1" NPT	1.36 (34.5)	.79 (20)	1.75 (44.5)
EN-3410-BR	3/4" NPT	1" NPT	1.38 (35)	.71 (18)	1.69 (43)

*O-Ring not Included
See page 56 for thread specifications.



Optional Locking Nuts, O-Rings & Other Accessories starting on Page 29 - 40.

Electrical Conduit provides protection to enclosed single or multi-conductors from impact, moisture, and chemical vapors. Varying quantities, sizes, and types of conductors can be pulled into a Conduit, which simplifies design and construction compared to multiple runs of cables or the expense of customized composite cables.

Conduit Systems can be made waterproof. Cable connections between fixed and moving parts are weak spots in machine & system installations. When cables are bent, individual tensioned conductors have no room for flexing. They are subjected to high and variable tension forces, particularly multi-conductor cables. To prevent conductor breakages, the use of Conduit tubing is recommended.

Advantages:

- Individual conductors are given sufficient flexibility to help prevent tension stress.
- Connections provide security against penetration of fluids.

NYLON (POLYAMIDE) SERIES

Flexible Polyamide cable conduit, standard and split options with removable fittings.



NYLON (POLYAMIDE) SUPERFLEX SERIES

Higher flexibility, an ideal solution for drag chain & robotic cables.



METAL SERIES

Cable conduit made of galvanized steel with a PVC shell (all fittings are removable).

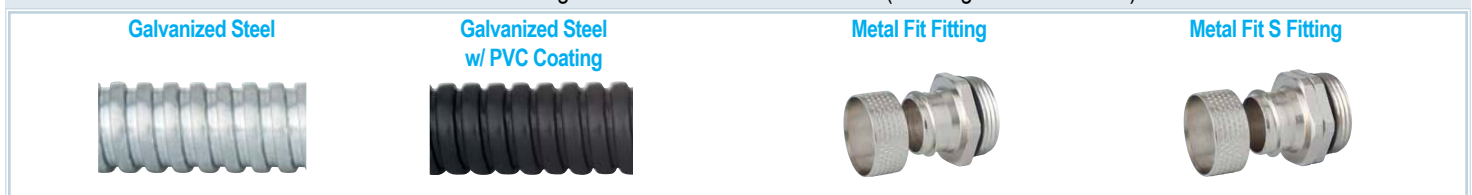

METAL PRO SERIES

Cable conduit made of galvanized steel with a PVC shell and braided option (all fittings are removable).



Conduit System - Nylon (Polyamide) Series

Solid & Slit Conduit



Conduit Systems

Solid Nylon Conduit: Polyamide - UL 94

Part Numbers -40°F to 248°F (-40°C to 120°C)	DN Size	Dimensions in Inches (mm)			
		d		Roll Length (ft.)	R mm
		Inner Diameter	Outer Diameter		
SM-0610-BK	6	.26 (6.5)	.39 (10)	328	15
SM-0811-BK	8	.33 (8.5)	.45 (11.4)	164	25
SM-1013-BK	10	.39 (10)	.51 (13)	328	25
SM-1216-BK	12	.47 (12)	.62 (15.8)	164	35
SM-1419-BK	14	.56 (14.2)	.72 (18.4)	164	35
SM-1721-BK	17	.65 (16.5)	.83 (21.2)	164	40
SM-2328-BK	23	.91 (23)	1.12 (28.4)	164	45
SM-2934-BK	29	1.14 (29)	1.36 (34.5)	82	55
SM-3642-BK	37	1.42 (36)	1.67 (42.5)	82	65
SM-4854-BK	50	1.89 (48)	2.15 (54.5)	82	80

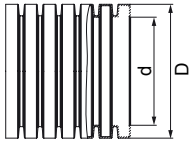

Nylon Polyamide cable conduits are characterised by their particularly high degree of flexibility. Whether in the standard or slotted version, even extremely mobile applications are no problem for the Nylon conduit. A large number of matching fittings and accessories provide solutions for all conceivable installation situations.



Slit Nylon Conduit: Polyamide

Part Numbers -40°F to 248°F (-40°C to 120°C)	DN Size	Dimensions in Inches (mm)			
		d		Roll Length (Ft.)	R mm
		Inner Diameter	Outer Diameter		
PS-0610-BK	6	.26 (6.5)	.39 (10)	328	15
PS-1013-BK	10	.39 (10)	.51 (13)	328	25
PS-1216-BK	12	.47 (12)	.62 (15.8)	164	35
PS-1418-BK	14	.56 (14.2)	.72 (18.4)	164	35
PS-1721-BK	17	.65 (16.5)	.83 (21.2)	164	40
PS-2328-BK	23	.91 (23)	1.12 (28.4)	164	45
PS-2935-BK	29	1.14 (29)	1.36 (34.5)	82	55
PS-3743-BK	37	1.42 (36)	1.67 (42.5)	82	65
PS-5055-BK	50	1.89 (48)	2.15 (54.5)	82	80

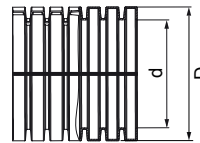

Conduit System - Nylon (Polyamide) Series

Mounting Bracket

- Quick assembly thanks to single-hole fixing
- Simply snaps into conduit

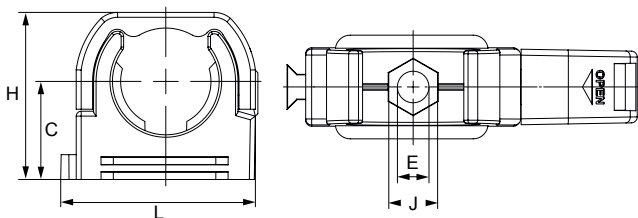

Mount Holds conduit securely in place.
Material: Polyamide PA 6
 • V0 Rated

Mounting Bracket: Snap-In - Nylon

Part Numbers -22°F to 176°F (-30°C to 80°C)	Fits Conduit DN Size	Dimensions Inches (mm)				
		H	L	C	J	E
		Body Height	Body Length	Height to Center	Screw Head Size	Screw Hole Size
PFC10	10	.62 (15.7)	1.13 (28.7)	1.08 (27.5)	.20 (5)	.28 (7)
PFC12	12	.52 (13.1)	1.17 (29.8)	.94 (24)	.21 (5.3)	.33 (8.3)
PFC14	14	.70 (17.75)	1.39 (35.2)	1.15 (29.3)	.21 (5.3)	.34 (8.5)
PFC17	17	.78 (19.75)	1.58 (40.2)	1.31 (33.2)	.21 (5.3)	.34 (8.5)
PFC23	23	.93 (23.5)	2.07 (52.6)	1.59 (40.5)	.21 (5.3)	.34 (8.5)
PFC29	29	1.16 (27)	2.39 (60.7)	1.89 (48)	.25 (6.5)	.43 (11)
PFC37	37	1.06 (30.4)	2.72 (69)	2.24 (57)	.25 (6.5)	.43 (11)
PFC50	50	1.49 (37.9)	3.43 (87)	2.80 (71)	.25 (6.5)	.43 (11)

Dome Fittings also available with the following approvals:





www.SealconEX.com

For Material Specifications and Approval Information refer to page 52.



Push-In Conduit Fittings: Straight & Elbow - Nylon

Part Numbers		Thread Type & Size	Fits Conduit DN Size	Straight Fittings - Dimens. in Inches (mm)				Elbow Fittings - Dimens. in Inches (mm)				
-4°F to 176°F (-20°C to 80°C)				A	TL	L	F	A	TL	H	L	F
		See page 56 for thread specs		Clearance Hole	Thread Length	Body Length	Wrench Flat	Clearance Hole	Thread Length	Body Height	Body Length	Wrench Flat
				+ .01" (+.25 mm)				+ .01" (+.25 mm)				
SM09AA-BK	EM09AA-BK	PG 9	10	.60 (15.2)	.31 (8)	.91 (23)	.67 (17)	.60 (15.2)	.31 (8)	1.70 (43)	.91 (23)	.75 (19)
SM11AA-BK	EM11AA-BK	PG 11	12	.73 (18.5)	.31 (8)	.99 (25)	.83 (21)	.73 (18.5)	.31 (8)	1.89 (48)	1.06 (27)	.87 (22)
SM13AA-BK	EM13AA-BK	PG 13/13.5	14	.80 (20.3)	.35 (9)	1.10 (28)	.95 (24)	.80 (20.3)	.35 (9)	2.05 (52)	1.20 (30.5)	.95 (24)
SM16AA-BK	EM16AA-BK	PG 16	17	.88 (22.3)	.39 (10)	1.15 (29)	1.06 (27)	.88 (22.3)	.39 (10)	2.20 (56)	1.28 (32.5)	1.06 (27)
SM21AA-BK	EM21AA-BK	PG 21	23	1.12 (28.4)	.43 (11)	1.26 (32)	1.38 (35)	1.12 (28.4)	.43 (11)	2.76 (70)	1.57 (40)	1.30 (33)
SM29AA-BK	EM29AA-BK	PG 29	29	1.47 (37.3)	.43 (11)	1.38 (35)	1.65 (42)	1.47 (37.3)	.43 (11)	3.27 (83)	2.03 (51.5)	1.65 (42)
SM36AA-BK	-	PG 36	37	1.85 (47)	.51 (13)	1.62 (41)	1.97 (50)	-	-	-	-	-
SM48AA-BK	-	PG 48	50	2.34 (59.4)	.55 (14)	1.81 (46)	2.52 (64)	-	-	-	-	-
SM09NA-BK	EM09NA-BK	3/8" NPT	10	.75 (19)	.60 (15)	.91 (23)	.67 (17)	.75 (19)	.60 (15)	1.81 (46)	.91 (23)	.75 (19)
SM16NA-BK	EM16NA-BK	1/2" NPT	17	1.18 (30)	.51 (13)	1.15 (29)	1.06 (27)	1.18 (30)	.51 (13)	2.20 (56)	1.28 (32.5)	1.06 (27)
SM21NA-BK	EM21NA-BK	3/4" NPT	23	1.52 (38.5)	.51 (13)	1.26 (32)	1.38 (35)	1.52 (38.5)	.51 (13)	2.76 (70)	1.57 (40)	1.30 (33)
SM29NA-BK	EM29NA-BK	1" NPT	29	1.81 (46)	.60 (15)	1.38 (35)	1.65 (42)	1.81 (46)	.60 (15)	3.27 (83)	2.03 (51.5)	1.65 (42)
SM16MA-BK	EM16MA-BK	M16 x 1.5	10	.79 (20)	.31 (8)	.91 (23)	.67 (17)	.79 (20)	.31 (8)	1.70 (43)	.91 (23)	.75 (19)
SM20MA-BK	EM20MA-BK	M20 x 1.5	14	1.04 (26.5)	.35 (9)	1.10 (28)	.95 (24)	1.04 (26.5)	.35 (9)	2.05 (52)	1.20 (30.5)	.95 (24)
SM25MA-BK	EM25MA-BK	M25 x 1.5	23	1.52 (38.5)	.43 (11)	1.26 (32)	1.38 (35)	1.52 (38.5)	.43 (11)	2.76 (70)	1.57 (40)	1.30 (33)
SM32MA-BK	EM32MA-BK	M32 x 1.5	29	1.81 (46)	.43 (11)	1.38 (35)	1.65 (42)	1.81 (46)	.43 (11)	3.27 (83)	2.03 (51.5)	1.65 (42)

*O-Rings Included on Elbow Fittings

O-Ring Groove



Locking Ridge Inside



SM - (Straight) Push-In Conduit Fittings

The fastest and most labor saving method to connect flexible Nylon Conduit to a Push-in Fitting. The Nylon Conduit is inserted into the Fitting until the hook snaps over the ridge of the Corrugated Tubing. The Conduit can be mounted rigid or turnable.

- IP 54 rating can be obtained with an O-Ring
- IP 65 rating can be obtained with a Fixed Installation

EM - (90° Elbow) Push-In Conduit Fittings

A combination of a unique 90° Snap Elbow and Straight Push-in Fitting. Elbow Fittings snap open & closed for easy installation of wires.

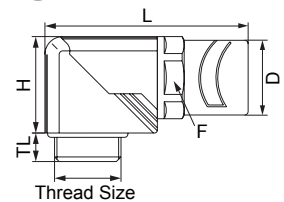
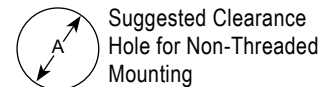
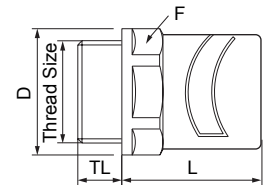

SM & EM Fittings feature a Locking Ridge to hold Conduit Tubing in place. They also have an O-Ring groove for optional O-Ring installation.



For Material Specifications and Approval Information refer to page 52.



Optional Locking Nuts, O-Rings & Other Accessories starting on Page 29 - 40.

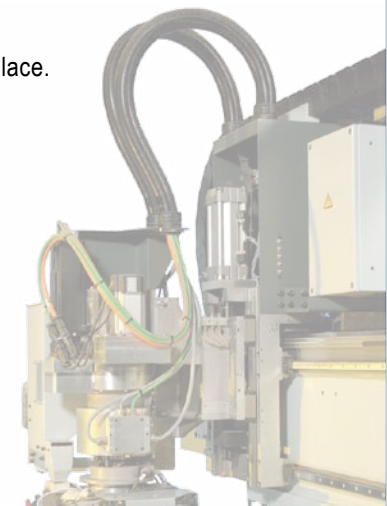

Conduit System - Nylon (Polyamide) Series

Y Fittings, 90° Fittings & Push-In Rotatable Fittings



Conduit Systems

Push-In Rotatable Fitting: Polyamide - IP 55

RoHS

Part Numbers	Thread Type & Size	Fits Conduit DN Size	Dimensions in Inches (mm)							
			A	d	D	TL	L	F		
			Clearance Hole +.01" (+.25 mm)	Inner Diameter	Outer Diameter	Thread Length	Body Length	Wrench Size		
-22°F to 176°F (-30°C to 80°C)										
	See page 56 for thread specs									
PFM1206-BK	M 12 X 1.5	6	.47 (12)	.27 (6.9)	.74 (18.7)	.43 (11)	1.02 (26)	.59 (15)		
PFM1610-BK	M 16 X 1.5	10	.63 (16)	.43 (10.9)	.85 (21.7)	.43 (11)	1.02 (26)	.71 (18)		
PFM1612-BK	M 16 X 1.5	12	.63 (16)	.43 (10.9)	1.02 (26)	.43 (11)	1.04 (26.5)	.79 (20)		
PFM2014-BK	M 20 X 1.5	14	.79 (20)	.58 (14.7)	1.10 (28)	.43 (11)	1.22 (31)	.91 (23)		
PFM2017-BK	M 20 X 1.5	17	.79 (20)	.60 (15.2)	1.26 (32)	.51 (13)	1.30 (33)	1.06 (27)		
PFM2523-BK	M 25 X 1.5	23	.98 (25)	.74 (18.7)	1.56 (39.5)	.63 (16)	1.53 (39)	1.34 (34)		
PFM3229-BK	M 32 X 1.5	29	1.26 (32)	1.01 (25.7)	1.83 (46.5)	.63 (16)	1.69 (43)	1.57 (40)		
PFM4037-BK	M 40 X 1.5	37	1.57 (40)	1.29 (32.7)	2.19 (55.5)	.63 (16)	1.79 (45.5)	1.97 (50)		
PFM5050-BK	M 50 X 1.5	50	1.97 (50)	2.02 (51.4)	2.66 (67.5)	.63 (16)	1.87 (47.5)	2.44 (62)		

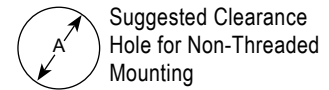
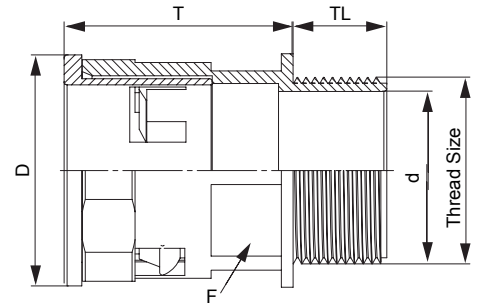

90° Fitting: Polyamide - IP 55

RoHS

Part Numbers	Thread Type & Size	Fits Conduit DN Size	Dimensions in Inches (mm)							
			A	d	D	TL	H	L		
			Clearance Hole +.01" (+.25 mm)	Inner Diameter	Outer Diameter	Thread Length	Height	Length		
-22°F to 176°F (-30°C to 80°C)										
	See page 56 for thread specs									
PEM1206-BK	M 12 X 1.5	6	.47 (12)	.32 (8.2)	.74 (18.7)	.43 (11)	1.43 (36.3)	1.41 (35.7)		
PEM1610-BK	M 16 X 1.5	10	.63 (16)	.43 (10.9)	.85 (21.7)	.43 (11)	1.47 (37.3)	1.52 (38.5)		
PEM1612-BK	M 16 X 1.5	12	.63 (16)	.43 (10.9)	1.02 (26)	.43 (11)	1.61 (41)	1.72 (43.8)		
PEM2014-BK	M 20 X 1.5	14	.79 (20)	.58 (14.7)	1.10 (28)	.43 (11)	1.73 (44)	1.81 (46)		
PEM2017-BK	M 20 X 1.5	17	.79 (20)	.60 (15.2)	1.26 (32)	.51 (13)	2.03 (51.5)	2.01 (51)		
PEM2523-BK	M 25 X 1.5	23	.98 (25)	.74 (18.7)	1.56 (39.5)	.63 (16)	2.41 (61.2)	2.53 (64.3)		

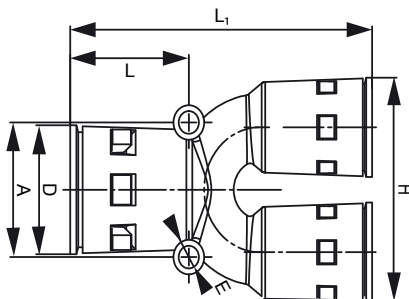
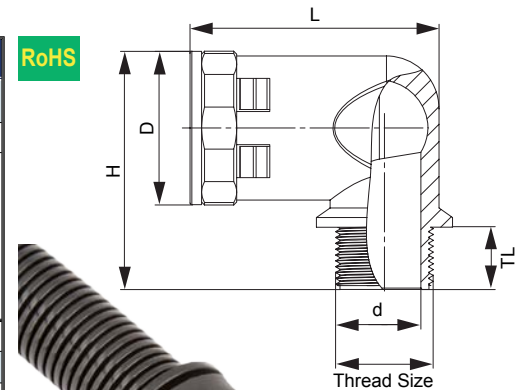

Y Fitting: Polyamide - IP 66

Part Numbers	Thread Type & Size	Fits Conduit DN Size	Dimensions in Inches (mm)							
			E	D	A	L	L ₁	H		
			Hole Diameter	Outer Diameter	Outer Diameter Ring	Upper Body Length	Body Length	Body Height		
-40°F to 248°F (-40°C to 120°C)										
	See page 56 for thread specs									
PFY100606	DN10/06/06	10/06/06	.20 (5)	.83 (21.2)	.83 (21.2)	1.29 (32.7)	2.72 (69.3)	1.11 (28.2)		
PFY121010	DN12/10/10	12/10/10	.22 (5.5)	.87 (22.3)	.87 (22.3)	1.22 (31)	2.91 (74)	1.65 (42)		
PFY171212	DN17/12/12	17/12/12	.26 (6.5)	1.10 (28)	1.10 (28)	1.26 (32)	3.35 (85)	2.01 (51)		
PFY231717	DN23/17/17	23/17/17	.26 (6.5)	1.43 (36.4)	1.43 (36.4)	1.50 (38)	3.56 (90.5)	2.51 (63.8)		
PFY292323	DN29/23/23	29/23/23	.26 (6.5)	1.70 (43)	1.70 (43)	1.46 (37)	4.17 (106)	3.02 (76.8)		
PFY372929	DN37/29/29	37/29/29	.26 (6.5)	2.07 (52.5)	2.07 (52.5)	1.90 (48.3)	4.95 (125.7)	3.78 (95.9)		
PFY503737	DN50/37/37	50/37/37	.26 (6.5)	2.62 (66.5)	2.62 (66.5)	2.08 (53)	5.04 (129)	4.31 (109.4)		



T Fittings: Polyamide - IP 67				
Part Numbers	Fits to Conduit Size	Fits Conduit DN Size	Dimens. in In. (mm)	
			H	L
-40°F to 248°F (-40°C to 120°C)			Height	Length
			PFT10	DN10
PFT12	DN12	12	.22 (5.5)	.87 (22.3)
PFT17	DN17	17	.26 (6.5)	1.10 (28)
PFT23	DN23	23	.26 (6.5)	1.43 (36.4)
PFT29	DN29	29	.26 (6.5)	1.70 (43)

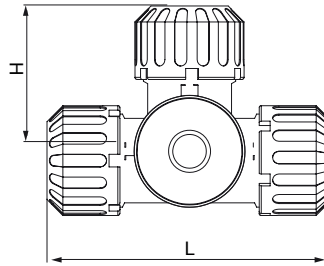

- **Combination of Strain Relief & Conduit Fittings**
- **Push-in system**
- **Rotatable**
- **Can be equipped with Multi-Hole inserts**
- **Metal style can be changed to EMI/RFI**
- **Metal Style also available in ATEX**

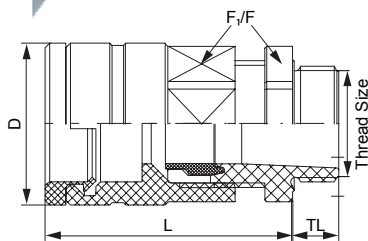
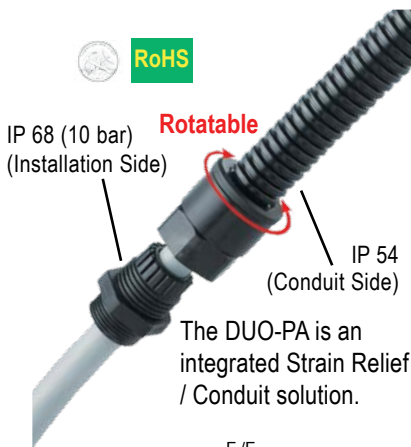

 Suggested Clearance Hole for Non-Threaded Mounting +.01" (+.25mm)

 Optional Locking Nuts, O-Rings & Other Accessories starting on Page 29 - 40.

DUO-PA Fittings: Straight - Nylon									
Part Numbers	Cable Range	Thread Type & Size	Fits Conduit DN Size	Dimensions in Inches (mm)					
				A	TL	L	D	F _v /F	
	Inches (mm)			Clearance Hole	Thread Length	Body Length	Outer Diameter	Wrench Flat	
				+ .01" (+.25 mm)					
DUO11AA-BK	.20 - .39 (5-10)	PG 11	10	.73 (18.5)	.31 (8)	1.57 (40)	.91 (23)	.87 (22)	
DUO13AA-BK	.24 - .47 (6-12)	PG 13/13.5	12	.80 (20.3)	.35 (9)	1.73 (44)	.98 (25)	.94 (24)	
DUO13AR-BK	.20 - .35 (5-9)								
DUO16AA-BK	.39 - .55 (10-14)	PG 16	14	.89 (22.5)	.39 (10)	1.85 (47)	1.14 (29)	1.06 (27)	
DUO16AR-BK	.28 - .47 (7-12)								
DUO21AA-BK	.51 - .63 (13-16)	PG 21	17	1.12 (28.4)	.43 (11)	1.97 (50)	1.18 (30)	1.30 (33)	
DUO21AR-BK	.35 - .63 (9-16)								
DUO29AA-BK	.71 - .87 (18-22)	PG 29	23	1.47 (37.3)	.43 (11)	2.36 (60)	1.54 (39)	1.65 (42)	
DUO29AR-BK	.51 - .79 (13-20)								
DUO36AA-BK	.87 - 1.10 (22-28)	PG 36	29	1.85 (47)	.51 (13)	2.72 (69)	1.77 (45)	2.09 (53)	
DUO42AA-BK	1.26 - 1.42 (32-36)								
DUO42AR-BK	.98 - 1.22 (25-31)	PG 42	37	2.13 (54.1)	.51 (13)	2.91 (74)	2.05 (52)	2.36 (60)	
DUO48AA-BK	1.46 - 1.73 (37-44)								
DUO48AR-BK	1.14 - 1.38 (29-35)	PG 48	50	2.34 (59.4)	.63 (14)	3.11 (79)	2.05 (52)	2.67 (68)	
DUO16MA-BK	.20 - .39 (5-10)	M16 x 1.5	10	.63 (16)	.31 (8)	1.57 (40)	.91 (23)	.86 (22)	
DUO16MR-BK	.12 - .28 (3-7)	M20 x 1.5	12	.79 (20)	.39 (10)	1.73 (44)	.98 (25)	.94 (24)	
DUO20MA-BK	.24 - .47 (6-12)								
DUO20MR-BK	.20 - .35 (5-9)	M20 x 1.5	14	.79 (20)	.39 (10)	1.81 (46)	1.14 (29)	1.06 (27)	
DUO22MA-BK	.39 - .55 (10-14)								
DUO22MR-BK	.28 - .47 (7-12)	M25 x 1.5	17	.98 (25)	.43 (11)	1.97 (50)	1.18 (30)	1.30 (33)	
DUO25MA-BK	.51 - .71 (13-18)								
DUO25MR-BK	.35 - .63 (9-16)	M32 x 1.5	23	1.26 (32)	.43 (11)	2.36 (60)	1.54 (39)	1.65 (42)	
DUO32MA-BK	.71 - .87 (18-22)								
DUO32MR-BK	.51 - .79 (13-20)	M40 x 1.5	29	1.57 (40)	.51 (13)	2.72 (69)	1.77 (45)	2.08 (53)	
DUO40MA-BK	.87 - 1.10 (22-28)								
DUO40MR-BK	.79 - 1.02 (20-26)	M50 x 1.5	37	1.97 (50)	.51 (13)	2.91 (74)	2.05 (52)	2.36 (60)	
DUO50MA-BK	1.26 - 1.42 (32-36)								
DUO50MR-BK	.98 - 1.22 (25-31)	M63 x 1.5	50	2.48 (63)	.63 (14)	3.11 (79)	2.05 (52)	2.67 (68)	
DUO63MA-BK	1.46 - 1.73 (37-44)								
DUO63MR-BK	1.14 - 1.38 (29-35)								
DUO16NA-BK	.39 - .55 (10 - 14)	NPT 1/2"	14	.83 (21.1)	.51 (13)	1.81 (46)	1.15 (29)	1.06 (27)	
DUO16NR-BK	.28 - .47 (7 - 12)	NPT 3/4"	17	1.05 (26.7)	.63 (14)	1.97 (50)	1.18 (30)	1.30 (33)	
DUO21NA-BK	.51 - .71 (13 - 18)								
DUO21NR-BK	.35 - .63 (9 - 16)	NPT 1"	23	1.35 (34.3)	.75 (19)	2.36 (60)	1.53 (39)	1.65 (42)	
DUO29NA-BK	.71 - .87 (18 - 24)								
DUO29NR-BK	.51 - .79 (13 - 20)	NPT 1-1/2"	29	1.92 (48.7)	.79 (20)	2.72 (69)	1.77 (45)	2.08 (53)	
DUO36NA-BK	.87 - 1.10 (22 - 31)								

Conduit System - Nylon (Polyamide) Series

Nickel Plated Brass DUO-MS Fitting



Nickel Plated Brass DUO-MS Fitting: Straight



Part Numbers	Cable Range Inches (mm)	Thread Type & Size	Fits Conduit DN Size	Dimensions in Inches (mm)				
				A Clearance Hole +.01" (+.25 mm)	TL Thread Length	L Body Length	D Outer Diameter	F _i /F Wrench Flat
DUO11AA-BR	.20 - .39 (5-10)	PG 11	10	.73 (18.5)	.24 (6)	1.42 (36)	.91 (23)	20/20
DUO11AR-BR	.12 - .28 (3-7)							
DUO13AA-BR	.24 - .47 (6-12)	PG 13/13.5	12	.80 (20.3)	.26 (6.5)	1.56 (39.5)	.98 (25)	24/22
DUO16AA-BR	.39 - .55 (10-14)							
DUO21AA-BR	.51 - .63 (13-16)	PG 21	17	1.12 (28.4)	.28 (7)	1.75 (44.5)	1.18 (30)	30/30
DUO21AR-BR	.35 - .63 (9-16)							
DUO29AA-BR	.71 - .87 (18-22)	PG 29	23	1.47 (37.3)	.31 (8)	1.99 (50.5)	1.54 (39)	40/40
DUO29AR-BR	.51 - .79 (13-20)							
DUO36AA-BR	.87 - 1.10 (22-28)	PG 36	29	1.85 (47)	.31 (8)	2.22 (56.5)	1.77 (45)	50/50
DUO16MA-BR	.20 - .39 (5-10)	M16 X 1.5	10	.63 (16)	.24 (6)	1.42 (36)	.91 (23)	20/20
DUO16MR-BR	.12 - .28 (3-7)							
DUO20MA-BR	.39 - .55 (10-14)	M20 X 1.5	12	.79 (20)	.24 (6)	1.56 (39.5)	.98 (25)	24/22
DUO20MR-BR	.28 - .47 (7-12)							
DUO22MA-BR	.39 - .55 (10-14)	M20 X 1.5	14	.79 (20)	.24 (6)	1.60 (40.5)	1.14 (29)	28/24
DUO22MR-BR	.28 - .47 (7-12)							
DUO25MA-BR	.51 - .71 (13-18)	M25 X 1.5	17	.98 (25)	.28 (7)	1.75 (44.5)	1.18 (30)	30/30
DUO25MR-BR	.35 - .63 (9-16)							
DUO32MA-BR	.71 - .87 (18-22)	M32 X 1.5	23	1.26 (32)	.31 (8)	1.99 (50.5)	1.54 (39)	40/40
DUO32MR-BR	.51 - .79 (13-20)							
DUO40MA-BR	.87 - 1.22 (22-31)	M40 X 1.5	29	1.57 (40)	.31 (8)	2.22 (56.5)	1.77 (45)	50/50
DUO40MR-BR	.79 - 1.02 (20-26)							
DUO50MA-BR	1.26 - 1.42 (32-36)	M50 X 1.5	37	1.97 (50)	.35 (9)	2.26 (57.5)	2.05 (52)	57/57
DUO63MA-BR	1.46 - 1.73 (37-44)	M63 X 1.5	50	2.48 (63)	.39 (10)	2.38 (60.5)	2.05 (52)	64/64
DUO63MR-BR	1.14 - 1.38 (29-35)							
DUO16NA-BR	.39 - .55 (10-14)	NPT 1/2"	14	.83 (21.1)	.51 (13)	1.81 (40.5)	1.14 (29)	28/24
DUO16NR-BR	.28 - .47 (7-12)							
DUO21NA-BR	.51 - .71 (13-18)	NPT 3/4"	17	1.05 (26.7)	.51 (13)	1.97 (44.5)	1.18 (30)	30/30
DUO21NR-BR	.35 - .63 (9-16)							
DUO29NA-BR	.71 - .87 (18-24)	NPT 1"	23	1.35 (34.3)	.63 (19)	2.36 (50.5)	1.54 (39)	40/23
DUO29NR-BR	.51 - .71 (13-20)							

Also available in NPT and Elongated Threads.

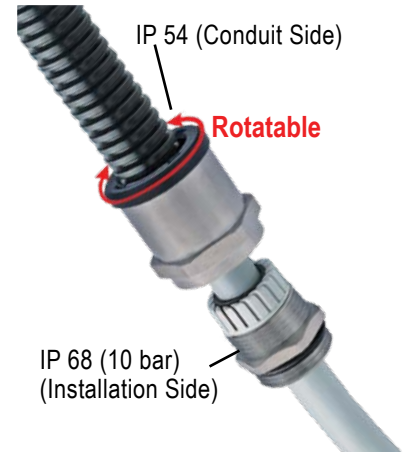

Metal style comes with O-Ring



Suggested Clearance Hole for Non-Threaded mounting +.01" (+.25mm).

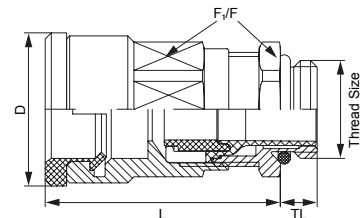

Optional Locking Nuts, O-Rings & Other Accessories starting on Page 29 - 40.

For Material Specifications and Approval Information refer to page 52.

Dome Fittings also available with the following approvals:





www.SealconEX.com

Bulkhead Conduit Fittings

- Combined Conduit and Cable Gland Fittings 2-in-1
- Clamping around entire circumference, ensuring maximum pull-out resistance
- No loose parts - Fitting does not have to be dismantled for assembly
- High degree of protection
- Bulkhead Fittings are manufactured from high-grade Nylon (Polyamide). Flange seal is Buna-N
- Split system: large cut-out size allows for quick & easy insertion of pre-assembled cables into a housing
- Protection rating: IP 54 / IP 65.
- V0 Rated

Bulkhead Fitting: Plastic - with Thread

Part Numbers -40°F to 230°F (-40°C to 110°C)	Thread Type & Size	Flange Type	Dimensions in Inches (mm)					
			L Length	W Width	H Height	G Distance	E Hole Diameter	
  PG 11 - 21 Flange 1 PG 29 - PG 48 Flange 2								
FL-11-BK	PG11	1	1.93 (49)	1.85 (47)	1.38 (35)	1.46 (37)	.17 (4.3)	
FL-16-BK	PG16	1	1.93 (49)	1.85 (47)	1.38 (35)	1.46 (37)	.17 (4.3)	
FL-21-BK	PG21	1	2.72 (69)	2.56 (65)	1.73 (44)	2.03 (51.6)	.24 (6.0)	
FL-29-BK	PG29	2	3.54 (90)	3.07 (78)	2.17 (55)	2.54 (64.5)	.26 (6.5)	
FL-36-BK	PG36	2	3.90 (99)	3.70 (94)	2.60 (66)	3.11 (79.5)	.26 (6.5)	
FL-48-BK	PG48	2	4.57 (116)	3.98 (101)	2.99 (76)	3.44 (87.5)	.26 (6.5)	

IP 65 Protection Rating



Advantages (Threaded):

- Split system enables pre-assembled cable harnesses to be inserted by means of removable upper part
- Easy assembly
 - High stability
 - Supplied with gasket for flange connection.
 - Internal thread for Metric and PG Fittings

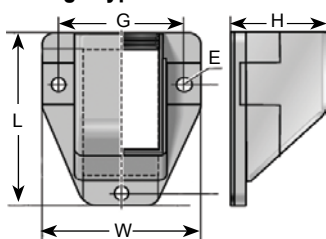

Flange Type 1: PG 11 - PG 21

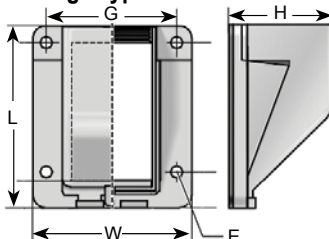

Flange Type 2: PG 29 - PG 48



Bulkhead Fitting: Plastic - without Thread

Part Numbers -40°F to 230°F (-40°C to 110°C)	Fits Nominal Conduit Size	Flange Type	Dimensions in Inches (mm)					
			L Length	W Width	H Height	G Distance	E Hole Diameter	
  DN 12 - DN 23 Flange 1 DN 29 - DN 48 Flange 2								
FT-11-BK	12	1	1.93 (49)	1.85 (47)	1.38 (35)	1.46 (37)	.17 (4.3)	
FT-16-BK	17	1	1.93 (49)	1.85 (47)	1.38 (35)	1.46 (37)	.17 (4.3)	
FT-21-BK	23	1	2.72 (69)	2.56 (65)	1.73 (44)	2.03 (51.5)	.24 (6.0)	
FT-29-BK	29	2	3.54 (90)	3.07 (78)	2.17 (55)	2.54 (64.5)	.26 (6.5)	
FT-36-BK	37	2	3.90 (99)	3.70 (94)	2.60 (66)	3.13 (79.5)	.26 (6.5)	
FT-48-BK	50	2	4.57 (116)	3.98 (101)	2.99 (76)	3.44 (87.5)	.26 (6.5)	

IP 54 Protection Rating



Advantages (Without Thread):

- Split system enables pre-assembled cable harnesses to be inserted by means of removable upper part
- Easy assembly
 - High stability
 - Supplied with gasket for flange connection.
 - Conduit remains rotatable

Flange Type 1: Conduit Size 12 - 23

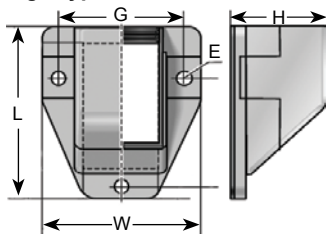

Flange Type 2: Conduit Size 29 - 48

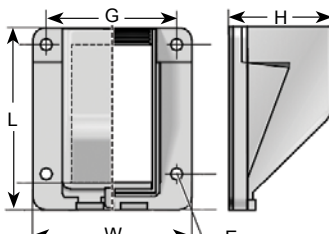

(Technical Drawings for Bulkhead Fittings with and without Threads)

*The design of the Bulkhead Fittings changes depending on size. Up to M25/PG 21 the Fitting has 3 screw holes, from size M32 / PG 29 the Fitting has 4 screw holes (see technical drawings).

The SUPER-FLEX Conduit is made of a special plastic blend. Due to its higher flexibility, it is an ideal solution for drag chain and robotics applications. The Conduit has a UL HB 22.86 LBF/in = Crush Resistance Flammability Rating.

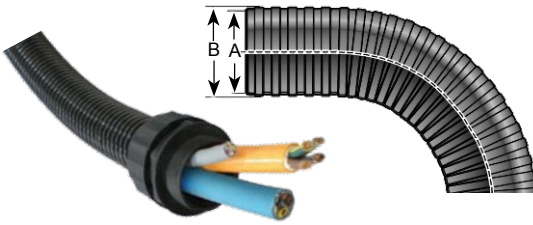

*CE Approval applies to SuperFlex Thermoplastic Elastomer and Standard Nominal Conduit Size 8 (SM-0811-BK)

Superflex Conduit: Thermoplastic Elastomer - IP 54, IP 65				
Part Numbers	DN Size	Roll Length (feet)	Dimensions	Fits Turn-to-Seal Fittings
-58°F to 320°F (-50°C to 160°C)			Inner Dia. (A) x Outer Dia. (B) Inches (mm)	ST, ET, SM & EM
Superflex Thermoplastic Elastomer				See page 56 for thread specs
SM-1013-HY	10	164	.39 x .51 (9.9 x 12.9)	PG 7, 3/8" NPT, PG 9, M16
SM-1216-HY	12	164	.48 x .62 (12.2 x 15.7)	PG 11, 3/8" NPT
SM-1721-HY	17	164	.65 x .83 (16.6 x 21)	PG 16, 1/2" NPT
SM-2328-HY	23	164	.88 x 1.12 (22.4 x 28.4)	PG 21, 3/4" NPT, M25
SM-2934-HY	29	82	1.11 x 1.36 (28.3 x 34.5)	PG 29, 1" NPT, M32
SM-3642-HY	37	82	1.40 x 1.67 (35.5 x 42.3)	PG 36, 1-1/4" NPT
SM-4854-HY	50	82	1.87 x 2.13 (47.5 x 54.2)	PG 48, 2" NPT

Turn-To-Seal Fittings: Straight & Elbow - Nylon

Part Numbers		Thread Type & Size	Fits Conduit DN Size	Straight Fitting - Dimensions in Inches (mm)						Elbow - Dimensions in Inches (mm)				
-40°F to 230°F (-40°C to 110°C)				TL	L	F	F ₁	E	A	TL	L	H	F	d
See page 56 for thread specs		Thread Length	Body Length	Wrench Flat (Body)	Wrench Flat (Dome)	Inside Diameter	Clearance Hole + .01" (+.25 mm)	Thread Length	Elbow Length	Elbow Height	Wrench Flat (Dome)	Inside Diameter		
ST07AA-BK	-	PG 7	10	.31 (8)	1.02 (26)	.75 (19)	.87 (22)	.33 (8.5)	.49 (12.5)	-	-	-	-	-
ST07AR-BK	-	PG 7	8	.31 (8)	1.02 (26)	.75 (19)	.87 (22)	.33 (8.5)	.49 (12.5)	-	-	-	-	-
ST09AA-BK	ET09AA-BK	PG 9	10	.31 (8)	1.02 (26)	.75 (19)	.87 (22)	.43 (11)	.60 (15.2)	.30 (7.5)	1.77 (45)	1.06 (27)	.87 (22)	.37 (9.5)
ST11AA-BK	ET11AA-BK	PG 11	12	.31 (8)	1.02 (26)	.87 (22)	.94 (24)	.55 (14)	.73 (18.5)	.31 (8)	2.01 (51)	1.14 (29)	.94 (24)	.51 (13)
ST16AA-BK	ET16AA-BK	PG 16	17	.31 (8)	1.02 (26)	1.06 (27)	1.18 (30)	.67 (17)	.89 (22.5)	.39 (10)	2.20 (56)	1.38 (35)	1.18 (30)	.63 (16)
ST21AA-BK	ET21AA-BK	PG 21	23	.39 (10)	1.34 (34)	1.50 (38)	1.50 (38)	.91 (23)	1.12 (28.4)	.43 (11)	2.64 (67)	1.61 (41)	1.50 (38)	.87 (22)
ST29AA-BK	ET29AA-BK	PG 29	29	.39 (10)	1.34 (34)	1.81 (46)	1.81 (46)	1.22 (31)	1.47 (37.3)	.47 (12)	3.23 (82)	2.09 (53)	1.81 (46)	1.14 (29)
ST36AA-BK	-	PG 36	37	.59 (15)	1.73 (44)	2.17 (55)	2.40 (61)	1.57 (40)	2.13 (54.1)	-	-	-	-	-
ST48AA-BK	-	PG 48	50	.59 (15)	1.97 (50)	2.55 (65)	2.91 (74)	2.01 (51)	2.34 (59.4)	-	-	-	-	-
ST11NA-BK	ET11NA-BK	3/8" NPT	12	.55 (14)	1.02 (26)	.87 (22)	.94 (24)	.47 (12)	.68 (17.2)	.31 (8)	2.01 (51)	1.14 (29)	.94 (24)	.51 (13)
ST16NA-BK	ET16NA-BK	1/2" NPT	17	.51 (13)	1.02 (26)	1.06 (27)	1.18 (30)	.55 (14)	.83 (21.1)	.39 (10)	2.20 (56)	1.38 (35)	1.18 (30)	.63 (16)
ST21NA-BK	ET21NA-BK	3/4" NPT	23	.55 (14)	1.22 (31)	1.46 (37)	1.50 (38)	.75 (19)	1.05 (26.7)	.43 (11)	2.64 (67)	1.61 (41)	1.50 (38)	.83 (21)
ST29NA-BK	ET29NA-BK	1" NPT	29	.75 (19)	1.25 (32)	1.81 (46)	1.81 (46)	1.02 (26)	1.35 (34.3)	.47 (12)	3.23 (82)	2.09 (53)	1.81 (46)	1.06 (27)
ST36NA-BK	-	1-1/4" NPT	37	.71 (18)	1.73 (44)	2.40 (61)	2.40 (61)	1.38 (35)	1.7 (43.2)	-	-	-	-	-

*Straight 2" NPT Also Available

ST & ET Fittings are V0 rated & have IP 65 protection without additional parts (O-Ring or Seal Ring).



ST - (Straight) Turn-To-Seal Conduit Fittings

- Reliable assembly as fitting is supplied pre-assembled. No additional parts required
- Integrated clamping ring ensures high tear-out strength
- IP 65 (Type NEMA 4) without additional parts
- Can be opened without tools



ET - (90° Angled Elbow) Turn-To-Seal Conduit Fittings

- Reliable assembly as fitting is supplied pre-assembled.
- No additional parts required
- Integrated clamping ring ensures high tear-out strength
- High protection to IP 65 without additional parts
- Can be opened without tools
- Smooth inside walls, therefore easy insertion of the cables into the 90° angle

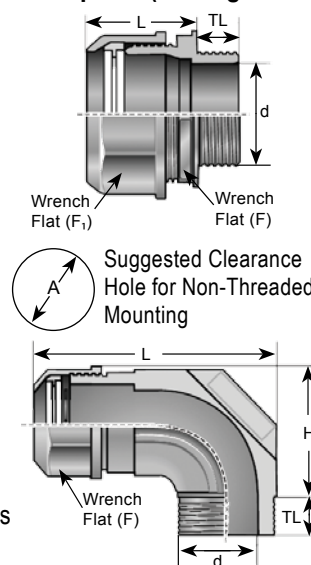

The Turn-to-Seal family consists of Conduit Fittings manufactured from high-grade polyamide. This design means that the Fittings offer a high protection rating of IP 65 (Type NEMA 4). The Fittings are completely pre-assembled and no additional parts such as cap nuts and clamping rings need to be fitted, ensuring reliability in assembly. The cable protection Conduit can be assembled quickly and easily by simply inserting the Conduit and turning the cap nut. The Elbow has smooth inside walls, making the installation of cables & wires easy. **V0 Rated!**



The Metal Series range of protective cable conduits are particularly resistant to mechanical stresses. The conduit pipes made of galvanized steel are able to withstand high pressure loads. Matching metal fittings complete the range, ensuring, that the system is 100% industrial grade.

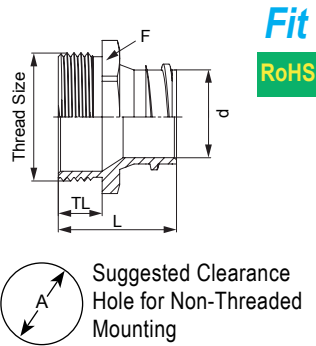

Galvanized Steel: - IP 40					
Part Numbers -148°F to 572°F (-100°C to 300°C)	DN Size	Dimensions in Inches (mm)			
		d Inner Diameter	D Outer Diameter	Roll Length (Ft.)	R mm
GS-0811-SA	7	.30 (7.5)	.41 (10.5)	164	25
GS-0912-SA	9	.35 (9)	.47 (12)	164	30
GS-1114-SA	11	.43 (11)	.55 (14)	164	30
GS-1417-SA	14	.55 (14)	.67 (17)	164	40
GS-1619-SA	16	.63 (16)	.75 (19)	164	45
GS-2124-SA	21	.83 (21)	.94 (24)	164	55
GS-2630-SA	26	1.02 (26)	1.18 (30)	82	55
GS-3741-SA	37	1.46 (37)	1.61 (41)	82	80
GS-4044-SA	40	1.57 (40)	1.73 (44)	82	80
GS-5155-SA	51	2.01 (51)	2.17 (55)	82	90

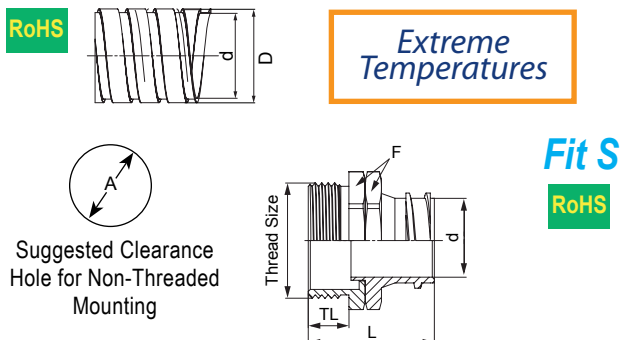

Galvanized Steel w/ PVC Coating : - IP 65					
Part Numbers -5°F to 158°F (-15°C to 70°C)	DN Size	Dimensions in Inches (mm)			
		d Inner Diameter	D Outer Diameter	Roll Length (Ft.)	R mm
GS-0812-SB	7	.30 (7.5)	.45 (11.5)	164	25
GS-0913-SB	9	.35 (9)	.51 (13)	164	30
GS-1115-SB	11	.43 (11)	.59 (15)	164	30
GS-1418-SB	14	.55 (14)	.71 (18)	164	40
GS-1620-SB	16	.63 (16)	.79 (20)	164	45
GS-2125-SB	21	.83 (21)	.98 (25)	164	55
GS-2631-SB	26	1.02 (26)	1.22 (31)	82	55
GS-3742-SB	37	1.46 (37)	1.65 (42)	82	80
GS-4045-SB	40	1.57 (40)	1.77 (45)	82	80
GS-5156-SB	51	2.01 (51)	2.20 (56)	82	90



Metal Fit Fitting: Nickel Plated Brass - IP 54							
Part Numbers -4°F to 176°F (-20°C to 80°C)	Thread Type & Size	Fits Conduit DN Size	Dimensions in Inches (mm)				
			A Clearance Hole +.01" (+.25 mm)	d Inner Diameter	TL Thread Length	L Body Length	F Wrench Flat
	See page 56 for thread specs						
MFM1207-BR	M12 X 1.5	7	.47 (12)	.24 (6)	.31 (8)	.94 (24)	.59 (15)
MFM1609-BR	M16 X 1.5	9	.63 (16)	.28 (7)	.31 (8)	.94 (24)	.79 (20)
MFM1611-BR	M16 X 1.5	11	.63 (16)	.35 (9)	.39 (10)	1.02 (26)	.79 (20)
MFM2014-BR	M20 X 1.5	14	.79 (20)	.47 (12)	.39 (10)	1.02 (26)	.87(22)
MFM2016-BR	M20 X 1.5	16	.79 (20)	.55 (14)	.39 (10)	1.02 (26)	.87 (22)
MFM2521-BR	M25 X 1.5	21	.98 (25)	.71 (18)	.39 (10)	1.06 (27)	1.10 (28)
MFM3226-BR	M32 X 1.5	26	1.26 (32)	.91 (23)	.47 (12)	1.22 (31)	1.38 (35)
MFM4037-BR	M40 X 1.5	37	1.57 (40)	1.32 (33.5)	.55 (14)	1.42 (36)	1.77 (45)
MFM5040-BR	M50 X 1.5	40	1.97 (50)	1.46 (37)	.55 (14)	1.42 (36)	2.17 (55)
MFM6351-BR	M63 X 1.5	51	2.48 (63)	1.81 (46)	.55 (14)	1.42 (36)	2.56 (65)
MFN1407-BR	NPT 1/4"	7	.49 (12.5)	.24 (6)	.39 (10)	1.02 (26)	.59 (15)
MFN3809-BR	NPT 3/8"	9	.68 (17.2)	.28 (7)	.45 (11.5)	1.08 (27.5)	.79 (20)
MFN3811-BR	NPT 3/8"	11	.68 (17.2)	.35 (9)	.45 (11.5)	1.08 (27.5)	.79 (20)
MFN1214-BR	NPT 1/2"	14	.83 (21.1)	.47 (12)	.51 (13)	1.14 (29)	.87 (22)
MFN1216-BR	NPT 1/2"	16	.83 (21.1)	.55 (14)	.51 (13)	1.14 (29)	.87 (22)
MFN3421-BR	NPT 3/4"	21	1.05 (26.7)	.71 (18)	.59 (15)	1.25 (32)	1.10 (28)
MFN1026-BR	NPT 1"	26	1.35 (34.3)	.91 (23)	.59 (15)	1.34 (34)	1.38 (35)
MFN5437-BR	NPT 1-1/4"	37	1.7 (43.2)	1.32 (33.5)	.63 (16)	1.50 (38)	1.77 (45)
MFN6440-BR	NPT 1-1/2"	40	1.9 (48.3)	1.46 (37)	.71 (18)	1.57 (40)	2.17 (55)
MFN2051-BR	NPT 2"	51	2.4 (61)	1.81 (46)	.79 (20)	1.65 (42)	2.56 (65)

Metal Fit S Fitting (Swivel): Nickel Plated Brass - IP 54							
Part Numbers -4°F to 176°F (-20°C to 80°C)	Thread Type & Size	Fits Conduit DN Size	Dimensions in Inches (mm)				
			A Clearance Hole +.01" (+.25 mm)	d Inner Diameter	TL Thread Length	L Body Length	F Wrench Flat
	See page 56 for thread specs						
MFSM1207-BR	M12 X 1.5	7	.47 (12)	.24 (6)	.31 (8)	1.06 (27)	.59 (15)
MFSM1609-BR	M16 X 1.5	9	.63 (16)	.28 (7)	.31 (8)	1.06 (27)	.79 (20)
MFSM1611-BR	M16 X 1.5	11	.63 (16)	.35 (9)	.39 (10)	1.14 (29)	.79 (20)
MFSM2014-BR	M20 X 1.5	14	.79 (20)	.47 (12)	.39 (10)	1.14 (29)	.87(22)
MFSM2016-BR	M20 X 1.5	16	.79 (20)	.55 (14)	.39 (10)	1.14 (29)	.87 (22)
MFSM2521-BR	M25 X 1.5	21	.98 (25)	.71 (18)	.39 (10)	1.22 (31)	1.10 (28)
MFSM3226-BR	M32 X 1.5	26	1.26 (32)	.91 (23)	.47 (12)	1.38 (35)	1.38 (35)
MFSM4037-BR	M40 X 1.5	37	1.57 (40)	1.32 (33.5)	.55 (14)	1.61 (41)	1.77 (45)
MFSM5040-BR	M50 X 1.5	40	1.97 (50)	1.46 (37)	.55 (14)	1.61 (41)	2.17 (55)
MFSM6351-BR	M63 X 1.5	51	2.48 (63)	1.81 (46)	.55 (14)	1.61 (41)	2.56 (65)
MFSN1407-BR	NPT 1/4"	7	.49 (12.5)	.24 (6)	.39 (10)	1.14 (29)	.59 (15)
MFSN3809-BR	NPT 3/8"	9	.68 (17.2)	.28 (7)	.45 (11.5)	1.20 (30.5)	.79 (20)
MFSN3811-BR	NPT 3/8"	11	.68 (17.2)	.35 (9)	.45 (11.5)	1.20 (30.5)	.79 (20)
MFSN1214-BR	NPT 1/2"	14	.83 (21.1)	.47 (12)	.51 (13)	1.25 (32)	.87 (22)
MFSN1216-BR	NPT 1/2"	16	.83 (21.1)	.55 (14)	.51 (13)	1.14 (32)	.87 (22)
MFSN3421-BR	NPT 3/4"	21	1.05 (26.7)	.71 (18)	.59 (15)	1.42 (36)	1.10 (28)
MFSN1026-BR	NPT 1"	26	1.35 (34.3)	.91 (23)	.59 (15)	1.54 (39)	1.38 (35)
MFSN5437-BR	NPT 1-1/4"	37	1.7 (43.2)	1.32 (33.5)	.63 (16)	1.69 (43)	1.77 (45)
MFSN6440-BR	NPT 1-1/2"	40	1.9 (48.3)	1.46 (37)	.71 (18)	1.77 (45)	2.17 (55)
MFSN2051-BR	NPT 2"	51	2.4 (61)	1.81 (46)	.79 (20)	1.85 (47)	2.56 (65)

A. Galvanized Steel w/ Smooth PVC Coating: - IP 66

Part Numbers	DN Size	Dimensions in Inches (mm)			
		d		Roll Length (Ft.)	R mm
		Inner Diameter	Outer Diameter		
-4°F to 221°F (-20°C to 105°C)					
MP-1016-SPA	10	.41 (10.3)	.63 (16)	98	40
MP-1218-SPA	12	.48 (12.3)	.71 (18)	98	45
MP-1621-SPA	16	.61 (15.5)	.83 (21)	98	65
MP-2127-SPA	21	.82 (20.9)	1.04 (26.5)	98	100
MP-2733-SPA	27	1.04 (26.5)	1.31 (33.3)	98	135
MP-3542-SPA	35	1.38 (35)	1.65 (42)	49	175
MP-4048-SPA	40	1.57 (40)	1.90 (48.2)	49	230
MP-5160-SPA	51	2.03 (51.5)	2.36 (60)	49	280

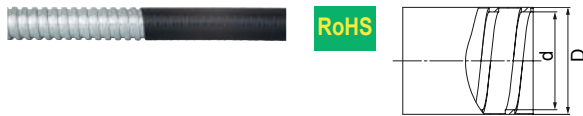

B. Galvanized Steel w/ Braid: - IP 40

Part Numbers	DN Size	Dimensions in Inches (mm)			
		d		Roll Length (Ft.)	R mm
		Inner Diameter	Outer Diameter		
-148°F to 572°F (-100°C to 300°C)					
MP-0914-SPB	9	.35 (9)	.55 (14)	164	1.18 (30)
MP-1116-SPB	11	.43 (11)	.63 (16)	164	1.38 (35)
MP-1318-SPB	13	.51 (13)	.69 (17.5)	164	1.57 (40)
MP-1621-SPB	16	.63 (16)	.83 (21)	164	1.77 (45)
MP-2126-SPB	21	.83 (21)	1.02 (26)	164	2.17 (55)
MP-2632-SPB	26	1.02 (26)	1.26 (32)	82	2.76 (70)
MP-3541-SPB	35	1.38 (35)	1.61 (41)	82	3.15 (80)
MP-4046-SPB	40	1.57 (40)	1.81 (46)	82	3.54 (90)
MP-5157-SPB	51	2.01 (51)	2.24 (57)	82	3.51 (90)



Extreme Temperatures

C. PVC Coated Galvanized Steel w/ Braid: - IP 65

Part Numbers	DN Size	Dimensions in Inches (mm)			
		d		Roll Length (Ft.)	R mm
		Inner Diameter	Outer Diameter		
-5°F to 158°F (-15°C to 70°C)					
MP-0915-SPC	9	.35 (9)	.55 (14)	164	1.18 (30)
MP-1117-SPC	11	.43 (11)	.63 (16)	164	1.38 (35)
MP-1319-SPC	13	.51 (13)	.69 (17.5)	164	1.57 (40)
MP-1622-SPC	16	.63 (16)	.83 (21)	164	1.77 (45)
MP-2127-SPC	21	.83 (21)	1.02 (26)	164	2.17 (55)
MP-2633-SPC	26	1.02 (26)	1.26 (32)	82	2.76 (70)
MP-3542-SPC	35	1.38 (35)	1.61 (41)	82	3.15 (80)
MP-4047-SPC	40	1.57 (40)	1.81 (46)	82	3.54 (90)
MP-5158-SPC	51	2.01 (51)	2.24 (57)	82	3.54 (90)

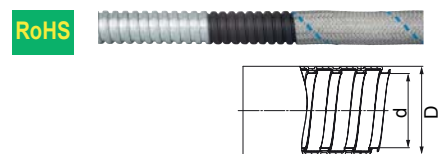

Optional Locking Nuts, O-Rings & Other Accessories starting on Page 29 - 40.

Metal Fit Pro: Nickel Plated Brass - IP 67

Part Numbers	Thread Type & Size	Fits Conduit DN Size A / B / C	Dimensions in Inches (mm)								
			A	d	D	TL	L	F ₁	F		
			Clearance Hole +.01" (+.25 mm)	Inner Diameter	Outer Diameter	Thread Length	Body Length	Wrench Flat	Wrench Flat		
											
MPM1209-BR	M12 X 1.5	- / 9 / 9	.47 (12)	.65 (16.5)	.96 (24.5)	.39 (10)	1.22 (31)	.79 (20)	.87 (22)		
MPM1611-BR	M16 X 1.5	10 / 11 / 11	.63 (16)	.75 (19)	1.15 (29.2)	.39 (10)	1.38 (35)	.94 (24)	1.02 (26)		
MPM1612-BR	M16 X 1.5	12 / 13 / 13	.63 (16)	.87 (22)	1.28 (32.6)	.45 (11.5)	1.54 (39)	1.06 (27)	1.14 (29)		
MPM2016-BR	M20 X 1.5	16 / 16 / 16	.79 (20)	.87 (22)	1.28 (32.6)	.51 (13)	1.52 (38.7)	1.06 (27)	1.14 (29)		
MPM2521-BR	M25 X 1.5	21 / 21 / 21	.98 (25)	1.08 (27.5)	1.53 (38.8)	.59 (15)	1.61 (41)	1.30 (33)	1.38 (35)		
MPM3226-BR	M32 X 1.5	27 / 26 / 26	1.26 (32)	1.36 (34.5)	1.97 (50)	.59 (15)	1.93 (49)	1.70 (43)	1.77 (45)		
MPM4035-BR	M40 X 1.5	35 / 35 / 35	1.57 (40)	1.71 (43.5)	2.36 (60)	.63 (16)	2.01 (51)	2.05 (52)	2.13 (54)		
MPM5040-BR	M50 X 1.5	40 / 40 / 40	1.97 (50)	1.95 (49.5)	2.73 (69.3)	.71 (18)	2.40 (61)	2.36 (60)	2.48 (63)		
MPM6351-BR	M63 X 1.5	51 / 51 / 51	2.48 (63)	2.44 (62)	3.35 (85)	.79 (20)	2.87 (73)	2.91 (74)	3.03 (77)		
MPN1410-BR	1/4" NPT	10 / 11 / 11	.49 (12.5)	.65 (16.5)	.96 (24.5)	.39 (10)	1.22 (31)	.79 (20)	.87 (22)		
MPN3812-BR	3/8" NPT	12 / 13 / 13	.68 (17.2)	.75 (19)	1.15 (29.2)	.45 (11.5)	1.38 (35)	.79 (20)	.87 (22)		
MPN1216-BR	1/2" NPT	16 / 16 / 16	.83 (21.1)	.87 (22)	1.28 (32.6)	.51 (13)	1.52 (38.7)	1.06 (27)	1.14 (29)		
MPN3421-BR	3/4" NPT	21 / 21 / 21	1.05 (26.7)	1.08 (27.5)	1.53 (38.8)	.59 (15)	1.61 (41)	1.30 (33)	1.38 (35)		
MPN1026-BR	1" NPT	27 / 26 / 26	1.35 (34.3)	1.36 (34.5)	1.97 (50)	.59 (15)	1.93 (49)	1.70 (43)	1.77 (45)		
MPN5435-BR	1-1/4" NPT	35 / 35 / 35	1.7 (43.2)	1.71 (43.5)	2.36 (60)	.63 (16)	2.01 (51)	2.05 (52)	2.13 (54)		
MPN6440-BR	1-1/2" NPT	40 / 40 / 40	1.9 (48.3)	1.95 (49.5)	2.73 (69.3)	.71 (18)	2.40 (61)	2.36 (60)	2.48 (63)		
MPN2051-BR	2" NPT	51 / 51 / 51	2.4 (61)	2.44 (62)	3.35 (85)	.79 (20)	2.87 (73)	2.91 (74)	3.03 (77)		

RoHS Fit Pro

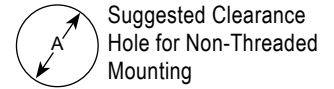
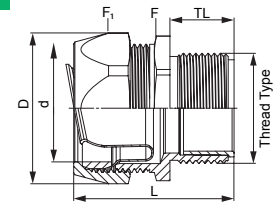

Metal Pro Series offers a safe protection against heat and cold, intense mechanical loads and abrasion. The conduits pipes are designed as multi-layer variants. They are available with PVC-Coating or exterior metal braiding. Fittings of the Metal Fit Pro Series provides perfect matching for all Metal Pro conduits.



Metal Fit Pro S (Swivel): Nickel Plated Brass - IP 67

Part Numbers	Thread Type & Size	Fits Conduit DN Size A / B / C	Dimensions in Inches (mm)								
			A	d	D	TL	L	F ₁	F		
			Clearance Hole +.01" (+.25 mm)	Inner Diameter	Outer Diameter	Thread Length	Body Length	Wrench Flat	Wrench Flat		
											
MPSM1209-BR	M12 X 1.5	- / 9 / 9	.47 (12)	.65 (16.5)	.96 (24.5)	.39 (10)	1.34 (34)	.79 (20)	.87 (22)		
MPSM1611-BR	M16 X 1.5	10 / 11 / 11	.63 (16)	.75 (19)	1.15 (29.2)	.39 (10)	1.38 (35)	.79 (20)	.87 (22)		
MPSM1612-BR	M16 X 1.5	12 / 13 / 13	.63 (16)	.87 (22)	1.28 (32.6)	.45 (11.5)	1.46 (37)	.94 (24)	1.02 (26)		
MPSM2016-BR	M20 X 1.5	16 / 16 / 16	.79 (20)	.87 (22)	1.28 (32.6)	.51 (13)	1.61 (41)	1.06 (27)	1.14 (29)		
MPSM2521-BR	M25 X 1.5	21 / 21 / 21	.98 (25)	1.08 (27.5)	1.53 (38.8)	.59 (15)	1.73 (44)	1.30 (33)	1.38 (35)		
MPSM3226-BR	M32 X 1.5	27 / 26 / 26	1.26 (32)	1.36 (34.5)	1.97 (50)	.59 (15)	2.01 (51)	1.70 (43)	1.77 (45)		
MPSM4035-BR	M40 X 1.5	35 / 35 / 35	1.57 (40)	1.71 (43.5)	2.36 (60)	.63 (16)	2.13 (54)	2.06 (52)	2.13 (54)		
MPSM5040-BR	M50 X 1.5	40 / 40 / 40	1.97 (50)	1.95 (49.5)	2.73 (69.3)	.71 (18)	2.52 (64)	2.36 (60)	2.48 (63)		
MPSM6351-BR	M63 X 1.5	51 / 51 / 51	2.48 (63)	2.44 (62)	3.35 (85)	.79 (20)	2.99 (76)	2.91 (74)	3.03 (77)		
MPSN1410-BR	1/4" NPT	10 / 11 / 11	.49 (12.5)	.65 (16.5)	.96 (24.5)	.39 (10)	1.38 (35)	.79 (20)	.87 (22)		
MPSN3812-BR	3/8" NPT	12 / 13 / 13	.68 (17.2)	.75 (19)	1.15 (29.2)	.45 (11.5)	1.46 (37)	.79 (20)	.87 (22)		
MPSN1216-BR	1/2" NPT	16 / 16 / 16	.83 (21.1)	.87 (22)	1.28 (32.6)	.51 (13)	1.61 (41)	1.06 (27)	1.14 (29)		
MPSN3421-BR	3/4" NPT	21 / 21 / 21	1.05 (26.7)	1.08 (27.5)	1.53 (38.8)	.59 (15)	1.73 (44)	1.30 (33)	1.38 (35)		
MPSN1026-BR	1" NPT	27 / 26 / 26	1.35 (34.3)	1.36 (34.5)	1.97 (50)	.59 (15)	2.01 (51)	1.70 (43)	1.77 (45)		
MPSN5435-BR	1-1/4" NPT	35 / 35 / 35	1.7 (43.2)	1.71 (43.5)	2.36 (60)	.63 (16)	2.13 (54)	2.05 (52)	2.13 (54)		
MPSN6440-BR	1-1/2" NPT	40 / 40 / 40	1.9 (48.3)	1.95 (49.5)	2.73 (69.3)	.71 (18)	2.52 (64)	2.36 (60)	2.48 (63)		
MPSN2051-BR	2" NPT	51 / 51 / 51	2.4 (61)	2.44 (62)	3.35 (85)	.79 (20)	2.99 (76)	2.91 (74)	3.03 (77)		

RoHS Fit Pro S

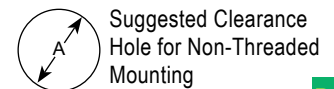
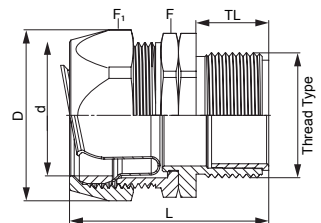

RoHS

Metal Fit Clip: Metal

Part Numbers	Fits to Metal Series	Fits to Metal Pro A	Fits to Metal Pro B,C	Size DN
				
MFC07	7	-	-	7
MFC09	9	-	-	9
MFC11	11	-	-	11
MFC14	11	-	-	14
MFC16	16	16	16	16
MFC21	21	21	21	21
MFC27	-	27	26	26/27
MFC35	35	35	35	35
MFC51	51	-	-	51



Optional Locking Nuts, O-Rings & Other Accessories starting on Page 29 - 40.

Nylon

Pressure Rating:
 150 PSIG (10 BAR) Type NEMA 4x, 6 (Submersible) & 12 - IP 68 / IP 69K

- Materials:**
 Fittings: Nylon 6/6 -
- V0 Rated - Flame resistant, Halogen and Phosphorous Free, Self-extinguishing, Non-toxic, Fungus resistant
 - Form Seal: Buna-N
 - Clamping Insert: Nylon
 - Optional O-Ring: Buna-N, FKM or Silicone
 - Optional Seal Ring: Polyethylene or Fiber-Reinforced Plastic

Operating Temperature:
 Nylon Fittings: -40°F to 212°F (-40°C to 100°C)
 Nylon Fitting w/ Aluminum Clamp: -4°F to 158°F (-20°C to 70°C)

- Available Colors:**
- Black (RAL 9005)
 - Gray (RAL 7035)
 - Blue (RAL 5012) (upon request)



All Black Nylon Fittings use the new UL f1 (746C) material. These products are ideally used in Photovoltaic / Solar / Outdoor applications requiring more (UV / Ozone Stable) material.

Nickel Plated Brass

Pressure Rating:
 150 PSIG (10 BAR) Type NEMA 4x, 6 (Submersible) & 12 - IP 68 / IP 69K

- Materials:**
- Fittings: Nickel Plated Brass
 - Spring (Flex Extension): 304 Stainless Steel
 - Form Seal: Buna-N (NBR) or FKM
 - Clamping Insert: PA (Nylon) or PVDF
 - O-Ring: Buna-N (NBR) FKM or Silicone optional
 - Optional Seal Ring: Polyethylene or Fiber-Reinforced Plastic

Operating Temperature:
 Buna-N: -40°F to 212°F (-40°C to 100°C)
 PVDF: -31°F to 302°F (-35°C to 150°C)

EMI Feed-Through
 Clamping Insert:
 Metal Coated Nylon

Nylon Splines 6/6: V0 rated - Flame resistant, halogen and phosphorous free, self extinguishing, non-toxic, fungus resistant

Nickel Plated Brass - WADI

Type	Operating Temperatures
• Mini WADI (Buna-N TPE)	-4°F to 212°F (-20°C to 100°C)
• Mini WADI (FKM)	-13°F to 392°F (-25°C to 200°C)
• WADI XL (Buna-N)	-4°F to 212°F (-20°C to 100°C)
	Metric: -40°F to 212°F (-40°C to 100°C)

Adapter, Reducer & Enlarger Materials

Materials	Operating Temperatures
• Nylon/Polypropylene	-4°F to 176°F (-20°C to 80°C)
• Nickel Plated Brass w/ Buna-N O-Ring	-40°F to 212°F (-40°C to 100°C)
• 303/316L Stainless Steel w/ Buna-N O-Ring	-4°F to 203°F (-20°C to 95°C)

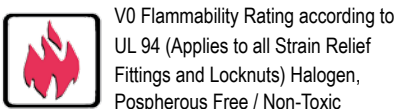

V0 Flammability Rating according to UL 94 (Applies to all Strain Relief Fittings and Locknuts) Halogen, Phosphorous Free / Non-Toxic

PVDF

Pressure Rating:
 150 PSIG (10 BAR) Type NEMA 4x, 6 (Submersible) & 12 - IP 68 / IP 69K

- Materials:**
- Fittings: PVDF (Polyvinylidene Flouride)
 - V0 Rated - Flame resistant, Halogen & Phosphorous Free, Self-extinguishing, Non-toxic, Fungus resistant
 - Form Seal: FKM
 - Clamping Insert: PVDF
 - Optional O-Ring: FKM
- Resistant to:**
- Acid
 - Salt solution
 - Oxydant
 - Halogens
 - Alcohols
 - Chlorinated solvent
 - Aliphatic hydrocarbons
 - Petrol

Operating Temperature:
 -31°F to 302°F (-35°C to 150°C)

Stainless Steel

Pressure Rating:
 150 PSIG (10 BAR) Type NEMA 4x, 6 (Submersible) & 12 - IP 68 / IP 69K

- Materials:**
- Fittings: (INOX) 303 Stainless Steel or 316L Stainless Steel
 - Form Seal: Buna-N (NBR) or FKM
 - Clamping Insert: PA (Nylon) or PVDF
 - O-Ring: Buna-N, FKM or Silicone

Operating Temperature:
 Buna-N: -40°F to 212°F (-40°C to 100°C)
 PVDF: -31°F to 302°F (-35°C to 150°C)

Insert Materials

Materials	Operating Temperatures
• Buna-N / TPE	-40°F to 212°F (-20°C to 100°C)
• Elastomer	-40°F to 212°F (-40°C to 100°C)
• FKM	-40°F to 392°F (-40°C to 200°C)
• Silicone (VMQ)	-76°F to 482°F (-60°C to 250°C)

O-Ring & Seal Ring Materials

Materials	Operating Temperatures
• Buna-N (NBR)	-22°F to 248°F (-30°C to 120°C)
• FKM	-40°F to 392°F (-40°C to 200°C)
• Silicone (VMQ)	-76°F to 482°F (-60°C to 250°C)
• Polyethylene	-22°F to 158°F (-30°C to 70°C)
• Fiber-reinforced Plastic	-40°F to 572°F (-40°C to 300°C)



ULF1 (746C)
 All Black Nylon (Dome & Flex) Strain Relief Fittings, Cord Grips, Cable Glands are now made with UV / Ozone Stable material.

UL/UR* E103997
 CSA 074032
 VDE 71339
 CAGE O UE11
 PATENT 4145075

* The following Nylon and Nickel Plated Brass Strain Relief Fittings are UR, but not UL listed:
 Sizes 3/8" NPT, M12, M16, PG7, PG9, PG11 and Multi-Hole fittings.
 The following Multi-Hole sizes are neither UL or UR rated:
 Sizes 1/2" NPT-E, M16-E, M20-E, M40, M50, M63

* The following Nylon and Nickel Plated Brass Strain Relief Fittings are UR, but not UL listed:
 • Sizes 3/8" NPT, M12, M16, PG7, PG9, and PG11

Dome Fittings also available with the following approvals:



www.SealconEX.com



Call for Technical Assistance:
 (800) 456-9012 / (303) 699-1135

Type NEMA stands for the National Electrical Manufacturers Association. It has established a range of standards for electrical equipment enclosures.

Type NEMA 1 General Purpose - Indoors

Type 1 - intended for general purpose indoor use primarily to provide a degree of protection against contact with the enclosed equipment or locations where unusual service conditions do not exist.

Type NEMA 2 Drip Proof - Indoors

Type 2 - intended for general purpose indoor use primarily to provide a degree of protection against limited amounts of falling water and dirt.

Type NEMA 3 Dust Tight, Rain Tight, & Ice/Sleet resistant - Indoors/Outdoors

Type 3 - intended for general purpose outdoor use primarily to provide a degree of protection against windblown dust, rain, and sleet; and to be undamaged by the formation of ice on the enclosure.

Type NEMA 3R Rain Proof & Ice/Sleet Proof - Indoors/Outdoors

Type 3R - intended for general purpose outdoor use primarily to provide a degree of protection against falling rain; and to be undamaged by the formation of ice on the enclosure.

Type NEMA 3S Dust Tight, Rain Tight, & Ice/Sleet Proof - Outdoors

Type 3S - intended for general purpose outdoor use primarily to provide a degree of protection against sleet; and to be undamaged by the formation of ice on the enclosure.

Type NEMA 4 Water Tight & Dust Tight - Indoors/Outdoors

Type 4 - intended for general purpose indoor or outdoor use primarily to provide a degree of protection against windblown dust and rain, splashing water, and hose directed water; and to be undamaged by the formation of ice on the enclosure.

Type NEMA 4x Water Tight, Dust Tight, & Corrosion Resistant - Indoors/Outdoors

Type 4X - intended for general purpose indoor and outdoor use primarily to provide a degree of protection against corrosion, windblown dust and rain, splashing water, and hose-directed water; and to be undamaged by the formation of ice on the enclosure.

Type NEMA 5 Superseded by NEMA 12 for Control Apparatus

Type 5 - see NEMA 12

Type NEMA 6 Submersible, Water Tight, Dust Tight, & Ice/Sleet Resistant - Indoors/Outdoors

Type 6 - intended for general purpose indoor or outdoor use primarily to provide a degree of protection against the entry of water during temporary submersion at a limited depth; and to be undamaged by the formation of ice on the enclosure.

Type NEMA 6P Submersible, Water Tight, Dust Tight, & Ice/Sleet Resistant - Indoors/Outdoors

Type 6P - Same as NEMA 6 including protection against the entry of water during prolonged submersion at a limited depth.

Type NEMA 7 Underwriters Lab Class 1-Groups C&D -Explosion Proof - Indoors

Type 7 - for indoor use in locations classified as Class I, Groups A, B, C, or D, as defined in the National Electrical Code.

Type 7 enclosures shall be capable of withstanding the pressures resulting from an internal explosion of specified gases, and contain such an explosion sufficiently that an explosive gas-air mixture existing in the atmosphere surrounding the enclosure will not be ignited. Enclosed heat generating devices shall not cause external surfaces to reach temperatures capable of igniting explosive gas-air mixtures in the surrounding atmosphere. Enclosures shall meet explosion, hydro-static, and temperature design tests.

Type NEMA 8 Underwriters Lab Class 1-Groups C&D -Explosion Proof - Indoors

Type 8 is same as NEMA 7, except the unit is oil-immersed

Type NEMA 9 Underwriters' Lab Class II - Groups E, F, G - Indoors

Type 9 - intended for special purpose indoor use in locations classified as hazardous (Class II, Groups E, F, or G, as defined in the National Electrical Code).

Type 9 enclosures shall be capable of preventing the entrance of dust. Enclosed heat generating devices shall not cause external surfaces to reach temperatures capable of igniting or discoloring dust on the enclosure or igniting dust-air mixtures in the surrounding atmosphere.

Enclosures shall meet dust penetration and temperature design tests, and aging of gaskets (if used).

Type NEMA 10 Bureau of Mines

Type NEMA 11 Corrosion Resistant & Drip Proof - Oil Immersed - Indoors

Type NEMA 12 Industrial Use - Dust Tight & Drip Tight - Indoors

Type 12 - intended for industrial indoor use primarily to provide a degree of protection against dust, falling dirt, and dripping noncorrosive liquids.

Type NEMA 13 Oil Tight & Dust Tight - Indoors

Type 13 - intended for industrial indoor use primarily to provide a degree of protection against dust, spraying of water, oil, and noncorrosive coolant.

Type NEMA Rating	NEMA 1	NEMA 2	NEMA 3	NEMA 3R	NEMA 3S	NEMA 4	NEMA 4x	NEMA 6	NEMA 6P	NEMA 12, 12K	NEMA 13
IP Class	IP 23	IP 30	IP 64	IP 32	IP 64	IP 66	IP 66	IP 66-68	IP 67-68	IP 65	IP 65
Indoor	✓	✓	-	-	-	-	-	-	-	✓	✓
Outdoor	-	-	✓	✓	✓	-	-	-	-	-	-
Indoor & Outdoor	-	-	-	-	-	✓	✓	✓	✓	-	-

The IP Code defined in international standard IEC 60529 classifies the degrees of protection provided against the intrusion of:

- Solid objects (including body parts like hands and fingers)
- Dust
- Accidental contact
- Water in electrical enclosures

It consists of the letters IP (for “International Protection Rating” or “Ingress Protection Rating”) followed by two digits and an optional letter. The standard aims to provide users more detailed information than vague marketing terms such as “waterproof”.

Level	Object size protected against	Effective against
0	-	No protection against contact and ingress of objects
1	>50 mm	Any large surface of the body, such as the back of a hand, but no protection against deliberate contact with a body part
2	>12.5 mm	Fingers or similar objects
3	>2.5 mm	Tools, thick wires, etc.
4	>1 mm	Most wires, screws, etc.
5	dust protected	Ingress of dust is not entirely prevented, but it must not enter in sufficient quantity to interfere with the satisfactory operation of the equipment; complete protection against contact
6	dust tight	No ingress of dust; complete protection against contact

Level	Protected against	Details
0	not protected	-
1	dripping water	Dripping water (vertically falling drops) shall have no harmful effect.
2	dripping water when tilted up to 15°	Vertically dripping water shall have no harmful effect when the enclosure is tilted at an angle up to 15° from its normal position.
3	spraying water	Water falling as a spray at any angle up to 60° from the vertical shall have no harmful effect.
4	splashing water	Water splashing against the enclosure from any direction shall have no harmful effect.
5	water jets	Water projected by a nozzle against enclosure from any direction shall have no harmful effects.
6	powerful water jets	Water projected in powerful jets against the enclosure from any direction shall have no harmful effects.
7	immersion up to 1 m	Ingress of water in harmful quantity shall not be possible when the enclosure is immersed in water under defined conditions of pressure and time (up to 1 m of submersion).
8	immersion beyond 1 m	The equipment is suitable for continuous immersion in water under conditions which shall be specified by the manufacturer. NOTE: Normally, this will mean that the equipment is hermetically sealed. However, with certain types of equipment, it can mean that water can enter but only in such a manner that produces no harmful effects.

IP 69K

German standard DIN 40050-9 extends the IEC 60529 rating system described above with an IP 69K rating for high-pressure, high-temperature wash-down applications.

Such enclosures must not only be dust tight (IP 6X), but also able to withstand high-pressure and steam cleaning.

The test specifies a spray nozzle that is fed with 80°C (176°F) water at 8–10 MPa (80–100 bar) and a flow rate of 14–16 L/min.

The nozzle is held 10–15 cm (3.94” - 5.91”) from the tested device at angles of 0°, 30°, 60° and 90° for 30 seconds each.

The test device sits on a turntable that rotates once every 12 s (5 rpm).

The IP 69K test specification was initially developed for road vehicles, especially those that need regular intensive cleaning (dump trucks, cement mixers, etc), but also finds use in other areas (e.g., food industry, railroad, marine, etc.)

The most commonly used protection methods are IP and Type NEMA, whereas:

- IP Classification – addresses the European market
- Type NEMA Classification – addresses the North American market

For questions please call our Inside Technical Sales Department at 1(800)-456-9012 or (303)-699-1135

Metric	Major Thread Diameter	Minor Thread Diameter	PG	Major Thread Diameter	Minor Thread Diameter	NPT	Major Thread Diameter	Minor Thread Diameter	Dome Opening
M6 x 1.0	6.0 mm / .24"	5.0 mm / .19"							3.0 mm / .11"
M8 x 1.25	8.0 mm / .31"	6.8 mm / .26"							5.0 mm / .19"
M10 x 1.5	10.0 mm / .40"	8.4 mm / .33"							6.0 mm / .24"
M12 x 1.5	12.0 mm / .47"	8.0 mm / .32"							6.5 mm / .26"
			PG 7	12.5 mm / .49"	11.3 mm / .49"	1/4"	12.5 mm / .49"	11.6 mm / .46"	6.5 mm / .26"
			PG 9	15.2 mm / .60"	13.9 mm / .54"	3/8"	16.8 mm / .66"	15.2 mm / .60"	8.0 mm / .31"
M16 x 1.5	16.0 mm / .63"	14.5 mm / .57"							8.0 mm / .31"
M16 X 1.5 E			PG 11	18.6 mm / .73"	17.3 mm / .68"				10.0 mm / .39"
M20 x 1.5	20.0 mm / .79"	18.5 mm / .72"							12.0 mm / .47"
			PG 13	20.4 mm / .89"	19.1 mm / .75"	1/2"	20.8 mm / .82"	18.8 mm / .74"	12.0 mm / .47"
M20 x 1.5 E			PG 16	22.5 mm / .89"	21.2 mm / .83"	1/2"-E	20.8 mm / .82"	18.8 mm / .74"	14.0 mm / .55"
M25 x 1.5	25.0 mm / .98"	23.5 mm / .92"							18.0 mm / .71"
			PG 21	28.3 mm / 1.11"	26.8 mm / 1.05"	3/4"	26.2 mm / 1.03"	24.1 mm / .95"	18.0 mm / .71"
M32 x 1.5	32.0 mm / 1.26"	30.5 mm / 1.20"							25.0 mm / .98"
			PG29	37.0 mm / 1.46"	35.5 mm / 1.46"	1"	32.8 mm / 1.29"	30.5 mm / 1.20"	25.0 mm / .98"
						1-1/4"	41.4 mm / 1.63"	38.1 mm / 1.50"	25.0 mm / .98"
M40 x 1.5	40.0 mm / 1.57"	38.5 mm / 1.51"							32.0 mm / 1.26"
			PG 36	47.0 mm / 1.85"	45.5 mm / 1.79"	1-1/2"	47.8 mm / 1.88"	45.7 mm / 1.80"	32.0 mm / 1.26"
M50 x 1.5	50.0 mm / 1.97"	48.5 mm / 1.90"							38.0 mm / 1.50"
			PG 42	54.0 mm / 2.13"	52.5 mm / 2.13"				38.0 mm / 1.50"
			PG 48	59.3 mm / 2.33"	57.8 mm / 2.72"				44.0 mm / 1.73"
M63 x 1.5	63.0 mm / 2.48"	61.5 mm / 2.42"							44.0 mm / 1.73"

Determine Sizes & Type of Fitting:

- Check markings on the hex portion (wrenching flats). PG, NPT or Metric size should be embedded. This only applies to Nylon parts.
- Measure major thread diameter and compare with chart above. This may tell you whether it is a PG, NPT or Metric thread (Nylon or Brass)
- Confirm grommet type inside fitting. (See table on right for grommet identification)
- The shorter length fittings are CD's (connector dome), the longer type are CF's (connector flex).
- We offer Enlarged as well as Reduced solutions. A PG13.5/16 has a PG13 thread with a PG16 body. Reduced would be the opposite (only in Nylon)
- The shading (grouping) indicates same size bodies, but different threads.

Grommet Identification	
Color	Type of Grommet
Black	Standard
Gray	Reduced
Beige	Multi-Hole / Solid Plug
Green	FKM
Red	Silicone
Blue	RG / FP Hygienic Glands

Note:

Dome Opening = the largest possible dimension diameter for one or more cables.

Recommended Torque Specifications for Strain Relief Fittings

Torque in in-lb - Inch-Pound (Nm - Newton Meters)

Sizes	Plastic Fittings		Metal Fittings	
	Dome Nuts	Thread & Lock Nuts	Dome Nuts	Thread & Lock Nuts
M6			17.7 (2)	17.7 (2)
M8			17.7 - 26.6 (2-3)	17.7 - 26.6 (2-3)
PG7, M12X1.5	14.4 (1.62)	22.1 (2.5)	36.9 (4.17)	55.3 (6.25)
PG 9, PG 11, PG 13, 3/8" NPT, 1/2" NPT, M16X1.5, M20X1.5	22.1 (2.5)	33.2 (3.75)	36.9 (4.17)	55.3 (6.25)
PG 16, 1/2" NPT-E	29.5 (3.33)	44.2 (5)	44.2 (5)	66.4 (7.5)
PG21, PG29, PG36, PG42, PG48, 3/4" NPT, 1" NPT 1-1/4" NPT, 1-1/2" NPT, M25, M32, M40, M50, M63	44.2 (5)	66.4 (7.5)	59 (6.67)	88.5 (10)

Note: Torque for dome nuts was determined using a metal rod. It may vary for cable, depending on the crush resistance of the cable. We recommend to determine the actual torque empirically, testing the actual cable used. The values shown above are for reference only. Torque Specification is based on Norm: EN 50262

The Pull-Test Rating of our Strain Relief Fittings complies with Industry Standards.

Pull-Test Rating: 35 lb.*

NPT Threads

Thread Size	1/4" NPT	3/8" NPT	1/2" NPT	3/4" NPT	1" NPT	1-1/4" NPT	1-1/2" NPT	2" NPT
Major Dia. in Inches (mm)	.54 (13.72)	.675 (17.145)	.84 (21.336)	1.05 (26.67)	1.314 (33.40)	1.66 (42.164)	1.90 (48.26)	2.375 (60.325)
Pitch in Inches (mm)	.056 (1.41)	.056 (1.411)	.071 (1.814)	.071 (1.814)	.087 (2.208)	.087 (2.208)	.087 (2.208)	.087 (2.208)
Threads per Inch	18	18	14	14	11.5	11.5	11.5	11.5

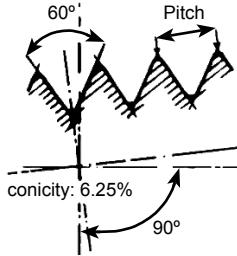

- NPT Thread = National Pipe Thread
- Taper rate for all NPT threads is 1/16
- The taper on NPT threads allows them to form a seal when torqued as the flanks of the threads compress against each other, as opposed to straight thread fittings

Metric Threads

Thread Size	M6	M8	M10	M12	M16	M20	M25	M32	M40	M50	M63
Major Dia. in Inches (mm)	.24 (6)	.31 (8)	.39 (10)	.47 (12)	.63 (16)	.79 (20)	.98 (25)	1.26 (32)	1.57 (40)	1.97 (50)	2.48 (63)
Pitch in Inches (mm)	.04 (1)	.05 (1.25)	.06 (1.5)	.059 (1.5)	.059 (1.5)	.059 (1.5)	.059 (1.5)	.059 (1.5)	.059 (1.5)	.059 (1.5)	.059 (1.5)
Thru Hole in Inches (mm)	.251 (6.4)	.33 (8.4)	.413 (10.5)	.492 (12.5)	.63 (16)	.79 (20)	.98 (25)	1.26 (32)	1.57 (40)	1.97 (50)	2.48 (63)

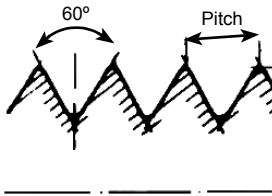

- World-wide most commonly used type thread
- Characterized by its major diameter and its pitch
- Designated by the letter M followed by the value of the nominal diameter and the pitch, both expressed in millimeters and separated by the multiplication sign 'x' (i.e. M12 x 1.5)

PG Threads

Thread Size	PG 7	PG 9	PG 11	PG 13 / 13.5	PG 16	PG 21	PG 29	PG 36	PG 42	PG 48
Major Dia. in Inches (mm)	.49 (12.5)	.60 (15.2)	.73 (18.6)	.80 (20.4)	.89 (22.5)	1.11 (28.3)	1.46 (37)	1.85 (47)	2.13 (54)	2.39 (59.3)
Pitch in Inches (mm)	.05 (1.27)	.056 (1.41)	.056 (1.41)	.056 (1.41)	.056 (1.41)	.062 (1.59)	.062 (1.59)	.062 (1.59)	.062 (1.59)	.062 (1.59)
Thru Hole in Inches (mm)	.50 (12.7)	.606 (15.4)	.74 (18.8)	.8149 (20.7)	.897 (22.8)	1.12 (28.6)	1.47 (37.4)	1.87 (47.5)	2.14 (54.5)	2.35 (59.8)

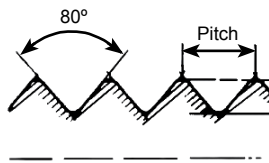

- PG Thread = Panzer-Gewinde (also Panzer-Rohr-Gewinde)
- German thread type
- Depth of thread smaller than NPT or Metric, but larger flank angle
- Straight thread

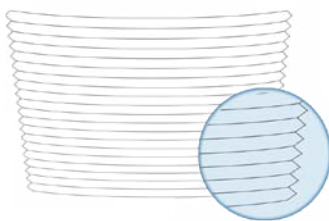

NPT Threads
(Tapered)

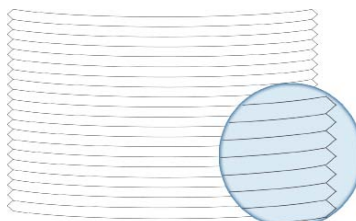

Metric Threads
(Straight)

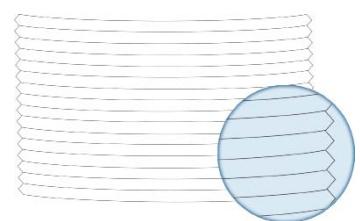



PG Threads
(Straight)

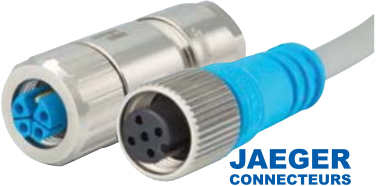

Circular Connector Options for every application!

The Industrial Ethernet is becoming increasingly important in the world of automation technology. In this era of industry 4.0 or IIOT (Industrial Ethernet of Things), everything is about the reliability and speed of data transmission. However, to ensure the performance reaches the end device to its full extent, choosing the right connection is a decisive factor. There are a variety of connector sizes and types which offer users a wide range of options: from classic solutions with signal and power plugs through to an innovative hybrid connection. The most typical choice is the 2 connector (signal + power) solution. There is a clear physical separation between data and power supply and the complexity of the wiring is fairly comprehensible. Separated shells and separated shields – if there is adequate space; everything is fine. However, the trend is for single cable solutions. This is despite ‘hybrid’ solutions opening up new potential for cost reduction since two cables and connectors become one. Installation expenses are reduced on site and space requirements are lessened. Summary: numerous connector series feature physical properties which allow end devices to be controlled using a fast Ethernet connection while simultaneously being supplied with power. In the target market, both performance data and the application itself should always be able to be assessed. The environment for the end application and how the user interacts with the plug system are important factors that often take precedence over purely technical aspects.

2-Plug Solutions		1-Plug Solutions	
<p>M23 Power RJ45</p>  <p>Our M23RJ45 connector system features suitable RJ45 patch cables which are housed in a sturdy nickel plated or optional stainless steel housing. The shielded patch cables are pre-assembled according to the requirements (e.g. Cat5 or Cat 5e) and integrated into the M23 connector. When physical performance is key, the classic M23 round connector is put into action. With 6, 8, or 9-pole inserts and performance data of 28A/630V, it is capable of covering the majority of applications.</p>	<p>M12 Power</p>  <p>The M12 series has already established itself over the past few years for data transmission via fast Ethernet using so-called ‘D-coding’. The 4-pole connector supplies bandwidths of up to 100 MHz (Cat5e). Our M12 power connector is a new addition to this model size, which is capable of transmitting power up to 16 A / 630 V despite being extremely miniaturized using new materials and contact systems. It is EMI capable thanks to the 360° shield feature. Available as K, L, S, and T coding.</p>	<p>M23 PoE</p>  <p>The M23 PoE connection system comes with the capability to have power and ethernet all in one shell. This connector is robust, safe, compact and is ideal for rough industrial environments. Data packages can be transmitted at up to 10 Gigabytes. With five separate shieldings, cross talking is virtually eliminated. Flame resistant, reliable crimp and solder contacts and vibration safe make this connector the solution to many applications.</p>	<p>M23 Hybrid</p>  <p>The new M23 hybrid (4+4+4) by HUMMEL is the compact all-in-one solution for the transmission of power, industrial Ethernet (IE) and signals. The plug-connector series unites the separate, shielded data transmission on 4 contacts according to CAT.5e with a high processing power on 4 additional power contacts (up to 28A and 630V). Data transmission rates of up to 500 MBit/s are possible without any problems. In addition 4 other contacts are available for signal transmission. The assembly time is minimal, the Ethernet element is simply snapped into place.</p>

M12 Power Circular Connector - Compact & Powerful!

Other Products / Index

Features

- 16 Amp & 630 Volt
- -40°F - 257°F (-40°C to 125°C)
- IP 67 & IP 69K
- EMI Ready
- V0 Rated Inserts
- K, L, S, T, Coding
- Robust & Compact
- Over Mold in Black & Blue
- Field Attachable
- Nickel Plated & Stainless Steel Options

Benefits

- Meets demand for more power with smaller footprint (space saving)
- Liquid & Spray Tight
- Shielded (EMI) for data applications
- Recessed Contacts (less bending)
- Self Aligns (Sturdy)
- Field Wireable

Applications

- Small Motors
- Encoders
- Lighting
- Heating
- Small Welding
- Instrumentation
- Material Handling
- Medical Equipment
- Scanning
- Industrial Fans



VARIA PRO SERIES! RAIL, TEMP, and CHEM

Demanding markets with special challenges, these are the ideal conditions for the Varia Pro Cable Glands. The Varia Pro Series features a slim, robust design. All three cable glands are IP68 to 10bar rated and built to hold up in the most extreme environments. Each insert variant is designed with different capabilities for very demanding requirements. However different, all cable glands have the Sealcon quality in common.



INCLUDES REDUCERS TO ACCOMMODATE A WIDER CABLE RANGE
Available in M20, M25, M32, M40

VariaPro
TEMP



VariaPro
RAIL



VariaPro
CHEM

EXIOS +A2F Raw Brass, Cable Glands, for Non-Armored Hazardous Duty Locations, Nylon 6 Clamping Insert, Silicone O-Ring & Seals, Protection Class V2, UL 94, IP 66/67/68, 5 Bar

Part Numbers -76°F to 221°F (-60°C to 105°C)	Gland Size	Thread Type See page 56 for thread specs	Cable Range Inches (mm)	Dimensions in Inches (mm)				
				A Clearance Hole +.01" (+.25 mm)	TL Thread Length	L Length	D Diameter	F Wrench Flat
YA09NK-BB	20 - 1	3/8" NPT*	24 - .47 (6 - 12)	.68 (17.2)	.63 (16)	1.40 (35.6)	1.06 (27)	.87 (22)
YA13NK-BB	20 - 1	1/2" NPT*	24 - .47 (6 - 12)	.83 (21.1)	.79 (20)	1.40 (35.6)	1.14 (29)	.87 (22)
YA13NM-BB	20 - 2N	1/2" NPT*	.35 - .63 (9 - 16)	.83 (21.1)	.79 (20)	1.44 (36.5)	1.06 (27)	.94 (24)
YA21NK-BB	20 - 3	3/4" NPT*	.49 - .81 (12.5 - 20.5)	1.05 (26.7)	.81 (20.5)	1.87 (47.5)	1.38 (35)	1.18 (30)
YA29NK-BB	25	1" NPT*	.67 - 1.02 (16.9 - 26)	1.35 (34.3)	.98 (25)	1.88 (47.8)	1.65 (42)	1.42 (36)
YA29LK-BB	32	1 1/4" NPT*	.87 - 1.30 (22 - 33)	1.65 (41.9)	1.02 (26)	2.01 (51.1)	2.05 (52)	1.81 (46)
YA36NK-BB	40	1 1/2" NPT*	1.10 - 1.61 (28 - 41)	1.92 (48.7)	1.04 (26.5)	2.24 (56.8)	2.52 (64)	2.17 (55)
YA50NK-BB	50	2" NPT*	1.57 - 2.07 (40 - 52.6)	2.375 (60.4)	1.06 (27)	2.57 (65.4)	2.87 (73)	2.56 (65)
YA52NK-BB	63	2 1/2" NPT*	2.01 - 2.40 (51 - 61)	2.875 (74.1)	1.57 (40)	2.77 (70.3)	3.54 (90)	3.15 (80)
YA30NK-BB	75	3" NPT*	2.44 - 3.07 (62 - 78)	3.50 (88.9)	1.63 (41.5)	3.00 (76.2)	4.21 (107)	3.74 (95)
YA16MK-BB	20 - 1	M16 x 1.5	24 - .47 (6 - 12)	.63 (16)	.63 (16)	1.40 (35.6)	1.06 (27)	.87 (22)
YA20MK-BB	20 - 1	M20 x 1.5	24 - .47 (6 - 12)	.79 (20)	.63 (16)	1.40 (35.6)	1.06 (27)	.87 (22)
YA20MM-BB	20 - 2	M20 x 1.5	.35 - .63 (9 - 16)	.79 (20)	.63 (16)	1.56 (39.7)	1.14 (29)	.94 (24)
YA25MK-BB	20 - 3	M25 x 1.5	.49 - .81 (12.5 - 20.5)	.98 (25)	.63 (16)	1.87 (47.5)	1.38 (35)	1.18 (30)
YA32MK-BB	25	M32 x 1.5	.67 - 1.02 (16.9 - 26)	.98 (25)	.63 (16)	1.88 (47.8)	1.65 (42)	1.42 (36)
YA40MK-BB	32	M40 x 1.5	.87 - 1.30 (22 - 33)	1.57 (40)	.63 (16)	2.01 (51.1)	2.05 (52)	1.81 (46)
YA50MK-BB	40	M50 x 1.5	1.10 - 1.61 (28 - 41)	1.97 (50)	.63 (16)	2.24 (56.8)	2.52 (64)	2.17 (55)
YA63MK-BB	50	M63 x 1.5	1.57 - 2.07 (40 - 52.6)	2.48 (63)	.63 (16)	2.57 (65.4)	2.87 (73)	2.56 (65)
YA75MK-BB	63	M75 x 1.5	2.01 - 2.57 (51 - 65.3)	2.95 (75)	.63 (16)	2.77 (70.3)	3.54 (90)	3.15 (80)
YA90MK-BB	75	M90 x 2.0	2.44 - 3.07 (62 - 78)	3.74 (90)	.79 (20)	3.00 (76.2)	4.21 (107)	3.74 (95)

With the EXIOS A2F, HUMMEL continues to follow the successful design of the EXIOS range of cable glands. This model is especially designed for unarmored and braided cables for the use in hazardous areas (cUS), Class 1, Zone 1, Zone 2, Zone 20, Zone 21 and Zone 22, where durability and quality is a must. Braid and cable jacket are fed into the Enclosure where the braid must be terminated inside.

The EXIOS A2F incorporates the time-proven Hummel clamping system, which offers a large clamping range in a small gland size. A smaller gland size can often be more cost effective.

- Halogen-free and Phosphorous-free
- Silicone Seal and O-Ring are standard

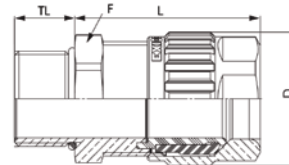
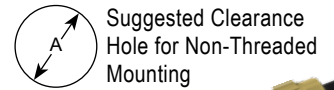

*All EXIOS in NPT do not come with an O-Ring

Materials Alternative Part Number Key (Last 2 letters)

- Parts listed above are Raw Brass, as indicated by the part number ending BB.
- For Nickel Plated Brass, order part number ending BR.
- For (316L) Stainless Steel, order part number ending SS.
- For Nickel Plated Brass Threads with Brass Body, order part number ending B1.
- Accessories Available.

This Gland can also be used in Non-Hazardous applications!

EXIOS A2F / Certificates

IEC 60079-0 / 2011	IEC 60079-1 / 2014-06	IEC 60079-7 / 2015	IEC 60079-31 / 2013	EN 60079-0 / 2009	EN 60079-1 / 2007
EN 60079-7 / 2007	EN 60079-31 / 2009	EN 60529	IECEx Nr. DEK 12.0039X	ATEX Nr. DEKRA 12ATEX0139 X	CSA: 12.2557737X

Visit www.SealconEX.com to see our wide variety of EX products!

Non-Armored Solutions

Ex-d Approved



Hi/Low Temperature & Chemical Resistant

(Nickel Plated Brass / 316L Stainless Steel)

Ex-e Approved



Standard / Multi-Hole / IS / Clamping

(Nylon / Nickel Plated Brass / 303 Stainless Steel)

Ex-i Approved



Intrinsically Safe (IS)

(Nickel Plated Brass / 316L Stainless Steel)



We Offer A Wide Variety Of Enclosures!

Sealcon provides customers a diverse selection of UL rated enclosure solutions to meet the demands of today's industries. Protecting vital components from the elements is a major priority, so our products are designed for both indoor and outdoor applications. To avoid assembly complications, specific integration services are available upon request and can be implemented on all enclosure solutions to ensure a functioning product for your assembly process.

Request your Enclosure Catalog Today:

800-456-9012 / 303-699-1135



CUSTOMIZATION



SPECIAL DESIGN



INTEGRATION SERVICES

Introducing the PolyCon Enclosure

Sealcon's Polycon enclosures are industrial polycarbonate enclosures with unique and innovative features, such as the integral nonmetallic latch and a corner elevator mounting system for adjustable hinged front kits and back panels.

Benefits:

- JIC sized, nonmetallic enclosure built with a new robust look and feel.
- Excellent impact and fire resistance making it a perfect solution for extreme applications.
- High level of technical features and approvals.
- Modifications and customizations available
 - Holes and Cutouts
 - Threads and Countersinking
 - Silk Screening
 - Ask for other available options!

Technical information

UL File no:	E189312
UL category:	NITW, NITW7
Environmental type (UL):	4X, 12, 13, 6P
Operating temperature:	-40° F... 176° F (-40° C ... +80° C)
Short term temperature range:	-40° F... 246° F (-40° C ... +120° C)
Flammability rating:	UL746C
Degree of protection:	IP66, IP68, and IP69
Impact resistance:	IK10



Sealcon Part No.	Hummel Part No.	Hummel Description	Sealcon Pg. No.
AF-xxxx-BK	1.239 / 1.273	E-M-PA / R-M-PA	36
AF-xxxx-BR	1.039	RE-Ms	35
AG-xxxx-BK	-	-	36
AG-xxxx-BR/-AL	1.171	RE-Ms	35
AM-xxxx-BK	-	-	36
AM-xxxx-BR	1.171	RE-Ms	35
AN-xxxx-BR	-	-	35
AP-xxxx-BK	1.239 / 1.273	E-M-PA / R-M-PA	36
AP-xxxx-BR	1.039	RE-Ms	35
AT-xxxx-BR	-	-	35
CDxxAA-BE	1.691	HSK-M-EMV	20
CDxxAA-BK/-GY	1.209	HSK-K	4
CDxx-AA-BR	1.609	HSK-M	14
CDxxAA-CP	1.215	HSK-K-MZ-Ex	9
CDxxAA-FE	1.631	HSK-M-EMV-D	21
CDxxAA-MZ	1.690	HSK-MZ	17
CDxxAA-RV	1.699	HSK-M-PVDF	26
CDxxAA-SS	1.695	HSK-INOX	27
CDxxAA-SV	1.696	HSK-INOX-PVDF	27
CDxxAA-TE	1.299	HSK-K-PVDF	25
CDxxAP-BK/-GY	1.597	HSK-K-Multi	10
CDxxAP-BR	1.697	HSK-M-Multi	22
CDxxAR-BE	1.691	HSK-M-EMV	20
CDxxAR-BK/-GY	1.209	HSK-K	4
CDxx-AR-BR	1.609	HSK-M	14
CDxxAR-RV	1.699	HSK-M-PVDF	26
CDxxAR-SS	1.695	HSK-INOX	27
CDxxAR-SV	1.696	HSK-INOX-PVDF	27
CDxxAR-TE	1.299	HSK-K-PVDF	25
CDxxAS-A1	1.587	HSK-K-FLAKA	9
CDxxAS-01/-04	1.587	HSK-K-FLAKA	9
CDxxAW-BR	1.112	HSK-MINI	16
CDxxAx-BK/-GY	1.597	HSK-K-Multi	10
CDxxAx-BR	1.697	HSK-M-Multi	22
CDxxBA-BK/-GY	1.591	HSK-KR	7
CDxxBR-BK/-GY	1.591	HSK-KR	7
CDxxCA-BE	1.691	HSK-M-EMV	20
CDxxCA-BK/-GY	1.209	HSK-K	6
CDxx-CA-BR	1.609	HSK-M	15
CDxxCA-MZ	1.690	HSK-MZ	17
CDxxCA-RV	1.699	HSK-M-PVDF	26
CDxxCR-BE	1.691	HSK-M-EMV	20
CDxxCR-BK/-GY	1.209	HSK-K	6
CDxx-CR-BR	1.609	HSK-M	15
CDxxCR-RV	1.699	HSK-M-PVDF	26
CDxxDA-BE	1.691	HSK-M-EMV	20
CDxxDA-BK/-GY	1.209	HSK-K	6
CDxx-DA-BR	1.609	HSK-M	15
CDxxDA-FE	1.631	HSK-M-EMV-D	21
CDxxDA-MZ	1.690	HSK-MZ	17
CDxxDA-RV	1.699	HSK-M-PVDF	26
CDxxDR-BE	1.691	HSK-M-EMV	20
CDxxDR-BK/-GY	1.209	HSK-K	6
CDxx-DR-BR	1.609	HSK-M	15
CDxxDR-FE	1.631	HSK-M-EMV-D	21
CDxxDR-MZ	1.690	HSK-MZ	17
CDxxDR-RV	1.699	HSK-M-PVDF	26

Sealcon Part No.	Hummel Part No.	Hummel Description	Sealcon Pg. No.
CDxxGA-BK/-GY	1.590	HSK-KE	7
CDxxGR-BK/-GY	1.590	HSK-KE	7
CDxx-LA-BK/-GY	1.209	HSK-K	4
CDxxLP-BK/-GY	1.597	HSK-K-Multi	11
CDxxLR-BK/-GY	1.209	HSK-K	4
CDxxMA-BE	1.691	HSK-M-EMV	20
CDxxMA-BK/-GY	1.209	HSK-K	5
CDxx-MA-BR	1.609	HSK-M	14
CDxxMA-FE	1.631	HSK-M-EMV-D	21
CDxxMA-MZ	1.690	HSK-MZ	17
CDxxMA-RV	1.699	HSK-M-PVDF	26
CDxxMA-SS	1.695	HSK-INOX	27
CDxxMA-SV	1.695	HSK-INOX-PVDF	27
CDxxMA-TE	1.299	HSK-K-PVDF	25
CDxxMP-BK/-GY	1.597	HSK-K-Multi	12
CDxxMP-BR	1.697	HSK-K-Multi	24
CDxxMR-BE	1.691	HSK-M-EMV	20
CDxxMR-BK/-GY	1.209	HSK-K	5
CDxx-MR-BR	1.609	HSK-M	14
CDxxMR-MZ	1.690	HSK-MZ	17
CDxxMR-RV	1.699	HSK-M-PVDF	26
CDxxMR-SS	1.695	HSK-INOX	27
CDxxMR-SV	1.696	HSK-INOX-PVDF	27
CDxxMR-TE	1.299	HSK-K-PVDF	25
CDxxMS-A1	1.587	HSK-K-FLAKA	9
CDxxMS-01/-04	1.587	HSK-K-FLAKA	9
CDxxMW-BR/-RV	1.106	HSK-MINI	16
CDxxMx-BK/-GY	1.597	HSK-K-Multi	12
CDxxMx-BR	1.697	HSK-M-Multi	24
CDxxNA-BE	1.691	HSK-M-EMV	20
CDxxNA-BK/-GY	1.209	HSK-K	4
CDxx-NA-BR	1.609	HSK-M	14
CDxxNA-FE	1.631	HSK-M-EMV-D	21
CDxxNA-MZ	1.690	HSK-MZ	17
CDxxNA-RV	1.699	HSK-M-PVDF	26
CDxxNA-6S	1.695	HSK-INOX	27
CDxxNA-6V	1.695	HSK-INOX	27
CDxxNA-TE	1.299	HSK-K-PVDF	25
CDxxNP-BK/-GY	1.597	HSK-K-Multi	11
CDxxNP-BR	1.697	HSK-M-Multi	23
CDxxNR-BE	1.691	HSK-M-EMV	20
CDxxNR-BK/-GY	1.209	HSK-K	4
CDxx-NR-BR	1.609	HSK-M	14
CDxxNR-RV	1.699	HSK-M-PVDF	26
CDxxNR-TE	1.299	HSK-K-PVDF	25
CDxxNS-A1	1.587	HSK-K-FLAKA	9
CDxxNS-01/-04	1.587	HSK-K-FLAKA	9
CDxxNx-BK/-GY	1.597	HSK-K-Multi	11
CDxxNx-BR	1.697	HSK-M-Multi	23
CFxxAA-BE	1.624	HSK-M-Flex-EMV	20
CFxxAA-BK/-GY	1.293 / 1.294	HSK-Flex	4
CFxx-AA-BR	1.623	HSK-M-Flex	14
CFxxAA-TE	-	NEEDS TO BE BUILT	25
CFxxAP-BR	-	NEEDS TO BE BUILT	22
CFxxAR-BE	1.624	HSK-M-Flex-EMV	20
CFxxAR-BK/-GY	1.293 / 1.294	HSK-Flex	4
CFxx-AR-BR	1.623	HSK-M-Flex	14

Sealcon Part No.	Hummel Part No.	Hummel Description	Sealcon Pg. No.
CFxxAR-TE	-	NEEDS TO BE BUILT	25
CFxxAx-BR	-	NEEDS TO BE BUILT	22
CFxxBA-BK/-GY	1.594	HSK-KR-Flex	7
CFxxBR-BK/-GY	1.594	HSK-KR-Flex	7
CFxxCA-BE	1.624	HSK-M-Flex-EMV	20
CFxxCA-BK/-GY	1.293 / 1.294	HSK-Flex	6
CFxx-CA-BR	1.623	HSK-M-Flex	15
CFxxCR-BE	1.624	HSK-M-Flex-EMV	20
CFxxCR-BK/-GY	1.293 / 1.294	HSK-Flex	6
CFxx-CR-BR	1.623	HSK-M-Flex	15
CFxxDA-BE	1.624	HSK-M-Flex-EMV	20
CFxxDA-BK/-GY	1.293 / 1.294	HSK-Flex	6
CFxx-DA-BR	1.623	HSK-M-Flex	15
CFxxDR-BE	1.624	HSK-M-Flex-EMV	20
CFxx-DR-BR	1.623	HSK-M-Flex	15
CFxxMA-BE	1.624	HSK-M-Flex-EMV	20
CFxxMA-BK/-GY	1.293 / 1.294	HSK-Flex	5
CFxx-MA-BR	1.623	HSK-M-Flex	14
CFxxMA-TE	-	NEEDS TO BE BUILT	25
CFxxMP-BR	-	NEEDS TO BE BUILT	24
CFxxMR-BE	1.624	HSK-M-Flex-EMV	20
CFxxMR-BK/-GY	1.293 / 1.294	HSK-Flex	5
CFxx-MR-BR	1.623	HSK-M-Flex	14
CFxxMR-TE	-	NEEDS TO BE BUILT	25
CFxxMx-BR	-	NEEDS TO BE BUILT	24
CFxxNA-BK/-GY	1.293 / 1.294	HSK-Flex	4
CFxx-NA-BR	1.623	HSK-M-Flex	14
CFxxNP-BR	-	NEEDS TO BE BUILT	23
CFxxNR-BK/-GY	1.293 / 1.294	HSK-Flex	4
CFxx-NR-BR	1.623	HSK-M-Flex	14
CFxxNx-BR	-	NEEDS TO BE BUILT	23
CXxxMx-BR	1.106	HSK-XL	16
DM-xx-BK/-GY	1.251	V-N-FS	32
DM-xx-BR	1.052	V-N-Ms	32
DM-xx-BR-B	1.052	V-N-Ms-SD	32
DP-xx-BK/-GY	1.251	V-N-FS	32
DP-xx-BR	1.052	V-N-Ms	32
DP-xx-BR-B	1.052	V-N-Ms-SD	32
DUOxxAA-BK	1.543	DUO-PA	45
DUOxxAA-BR	1.548	DUO-Ms	46
DUOxxAR-BK	1.543	DUO-PA	45
DUOxxAR-BR	1.548	DUO-Ms	46
DUOxxMA-BK	1.542	DUO-PA	45
DUOxxMA-BR	1.547	DUO-Ms	46
DUOxxMR-BK	1.542	DUO-PA	45
DUOxxMR-BR	1.547	DUO-Ms	46
EDxxAA-BK/-GY	1.313	HSK-W	8
EDxxAA-BR	1.309	HSK-M-W	17
EDxxAR-BK/-GY	1.313	HSK-W	8
EDxxAR-BR	1.309	HSK-M-W	17

Sealcon Part No.	Hummel Part No.	Hummel Description	Sealcon Pg. No.
EDxxFA-BR	1.309	HSK-M-W	17
EDxxFR-BR	1.309	HSK-M-W	17
EDxxMA-BK/-GY	1.313	HSK-W	8
EDxxMA-BR	1.309	HSK-M-W	17
EDxxMR-BK/-GY	1.313	HSK-W	8
EDxxMR-BR	1.309	HSK-M-W	17
EDxxNA-BK/-GY	1.313	HSK-W	8
EDxxNR-BK/-GY	1.313	HSK-W	8
EFxxAA-BK/-GY	1.314	HSK-W-Flex	8
EFxxAR-BK/-GY	1.314	HSK-W-Flex	8
EFxxMA-BK/-GY	1.314	HSK-W-Flex	8
EFxxMR-BK/-GY	1.314	HSK-W-Flex	8
EFxxNA-BK/-GY	1.314	HSK-W-Flex	8
EFxxNR-BK/-GY	1.314	HSK-W-Flex	8
EMxxAA-BK	1.513	Elbow Push-In	43
EMxxMA-BK	1.513	Elbow Push-In	43
EMxxNA-BK	1.513	Elbow Push-In	43
EM-xxxx-BK	1.239	E-M-PA	40
EM-xxxx-BR	1.033	E-Ms	40
EN-xxxx-BR	-	-	40
EP-xxxx-BR	1.033	E-Ms	40
ETxxNA-BK	1.223	Elbow Turn-to-Seal	48
FL-xx-BK	1.312	Bulkhead Fitting	47
FT-xx-BK	1.312	Bulkhead Fitting	47
GS-xxxx-SA	1.560	Metal Series Conduit	49
GS-xxxx-SB	1.561	Metal Series Conduit	49
HM-xx-BK	1.255	V-NE	32
HM-xx-BR	1.155	V-NE-Ms	33
HM-xx-BR-B	1.156	V-NE-Ms-SD	33
HM-xx-BR-V	1.157	V-NE-Ms-SD-FKM	33
HM-xx-SS-B	1.152	V-INOX	33
HM-xx-SS-S	1.154	V-INOX-VMQ	33
HM-xx-SS-V	1.153	V-INOX-FKM	33
HN-xx-BK	-	-	32
HP-xx-BK	1.255	V-NE	32
HP-xx-BR	1.155	V-NE-Ms	33
HP-xx-BR-B	1.156	V-NE-Ms-SD	38
HP-xx-BR-V	1.157	V-NE-Ms-SD-FKM	33
HP-xx-SS-B	1.152	V-INOX-NBR	33
HP-xx-SS-S	1.154	V-INOX-VMQ	33
HP-xx-SS-V	1.153	V-INOX-FKM	33
KLxxMA-BR	1.143	KLE	34
MFCxx	1.574	Metal Fit Clip	51
MFxxxx-BR	1.570	Metal Fit	49
MFSxxxx-BR	1.571	Metal Fit S	49
MP-xxxx-SPA	1.562	Metal Pro Series Conduit	50
MP-xxxx-SPB	1.563	Metal Pro Series Conduit	50
MP-xxxx-SPC	1.564	Metal Pro Series Conduit	50
MPMxxxx-BR	1.572	Metal Fit Pro	51
MPSMxxxx-BR	1.573	Metal Fit Pro S	51
NM-xx-BE	1.167	GM-EMV	30

Sealcon Part No.	Hummel Part No.	Hummel Description	Sealcon Pg. No.
NM-xx-BK/-GY	1.262	GM-FS	29
NM-xx-BR	1.161	GM-Ms	29
NM-xx-XL	1.161	GM-Ms (XL)	16
NN-xx-BE	-	-	30
NN-xx-BK/-GY	1.262	GM-FS	29
NN-xx-BR	1.161	GM-Ms	29
NN-xx-ST	-	-	30
NP-xx-BE	1.167	GM-EMV	30
NP-xx-BK/-GY	1.262	GM-FS	29
NP-xx-BR	1.161	GM-Ms	29
OM-xx-BN/-VT	1.321	O-Ring	31
OM-xx-SI	1.321	O-Ring / Silicone	31
OR-xx-BN/-VT	1.321	O-Ring	31
OR-xx-SI	1.321	O-Ring / Silicone	31
PEMxxx-BK	1.535	90° Fitting	44
PFCxx	1.534	Mounting Bracket	42
PFMxxx-BK	1.533	Push-In Rotatable	44
PFTxx	1.536	T Fitting	45
PFYxxxxx	1.537	Y Fitting	44
PL-xx-BK	1.280	HSK-V	31
PS-xxx-BK	1.527	Slit Conduit	42

Sealcon Part No.	Hummel Part No.	Hummel Description	Sealcon Pg. No.
RB-xxxx-02	-	-	38
RM-xxxx-BK	1.273	R-M-PA	38
RM-xxxx-BR	1.077	RSD-Ms	37
RM-xxxx-SS	1.094	RS-INOX	39
RM-xxxx-SS-B	1.097	RSD-INOX	39
RN-xxxx-BR	-	-	37
RP-xxxx-BR	1.074	RS-Ms	37
RP-xxxx-SS	1.094	RS-INOX	39
RQ-xxxx-BR	1.077	RSD-Ms	37
RQ-xxxx-SS	1.097	RSD-INOX	39
RR-xxxx-BR	1.071 / 1.076	R-H	37
RR-xxxx-GY	1.236 / 1.272	R-FS	38
SM-xxxx-HY	1.524	Superflex Conduit	48
SMxxAA/MA-BK	1.511	Straight Push-In	43
SMxxNA-BK	1.511	Straight Push-In	43
SM-xx-NY/-HD	1.325	Thread Seal Rings	31
SM-xxxx-BK	1.510	Solid Conduit	42
SR-xx-NY/-HD	1.325	Thread Seal Rings	31
STxxAA/NA-BK	1.220	Straight Turn-to-Seal	48



Sealcon's M12 Cordsets are ideal for Automation and Manufacturing!

Automation in manufacturing is increasing at the speed of technology. With IIoT and smart machines, a durable and reliable connectivity solution is required to maximize output. Sealcon now has M12 connector cordsets that are ideal for your application and will meet and exceed the demands of the industry. With straight male and female, right angle and open ended cordsets available, numerous options are possible. Whether you are looking for just a few or few thousand cordsets, Sealcon can provide the solution.

Contact Sealcon today to reference your application!

Coding Options: A, B, D
PINS: 4, 5, 6, 8

Cable Jacket: PVC or PUR
Length: 2m, 3m, 5m, 10m

Endless Applications Including:

- Motors
- Lighting
- Conveyors
- Robotics
- Actuators
- Drives
- Instrumentation
- Sensors





Protection: IP 67
Operating Temperature: -22°F - 158°F (-30°C - 70°C)
Contact Material: Brass
Contact Surface: Nickel
Inserts: V0 PA66 / Fiber Glass
Overmold: Thermoplastic Elastometer







Yellow M12
Straight Male Thread

Yellow M12
Right Angle
Female Thread



 7374 S. Eagle Street Centennial, CO 80112 USA
 800-456-9012 / 303-699-1135
 Info@SealconUSA.com
 www.SealconUSA.com

 [linkedin.com/company/sealcon](https://www.linkedin.com/company/sealcon)
 [facebook.com/SealconLLC](https://www.facebook.com/SealconLLC)
 twitter.com/Sealcon
 vimeo.com/sealcon