

Features

- Generation VTechology
- Ultra Low On-Resistance N-ChannelMofset
- Surface Mount
- Dynamic dv/dt Rating
- Fast Switching
- Lead-Free

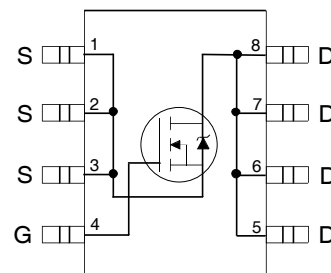

Top View

Description

The SOP-8 has been modified through a customized leadframe for enhanced thermal characteristics and multiple-die capability making it ideal in a variety of power applications. With these improvements, multiple devices can be used in an application with dramatically reduced board space. The package is designed for vapor phase, infra red, or wave soldering techniques. Power dissipation of greater than 0.8W is possible in a typical PCB mount application.

Absolute Maximum Ratings

	Parameter	Max.	Units
$I_D @ T_A = 25^\circ\text{C}$	10 Sec. Pulsed Drain Current, $V_{GS} @ 10\text{V}$	9.7	A
$I_D @ T_A = 25^\circ\text{C}$	Continuous Drain Current, $V_{GS} @ 10\text{V}$	8.5	
$I_D @ T_A = 70^\circ\text{C}$	Continuous Drain Current, $V_{GS} @ 10\text{V}$	5.4	
I_{DM}	Pulsed Drain Current $\text{\textcircled{1}}$	34	
$P_D @ T_A = 25^\circ\text{C}$	Power Dissipation	2.5	W
	Linear Derating Factor	0.02	W/ $^\circ\text{C}$
V_{GS}	Gate-to-Source Voltage	± 20	V
dv/dt	Peak Diode Recovery dv/dt $\text{\textcircled{2}}$	5.0	V/ns
T_J, T_{STG}	Junction and Storage Temperature Range	-55 to + 150	$^\circ\text{C}$

Thermal Resistance Ratings

	Parameter	Typ.	Max.	Units
$R_{\theta JA}$	Maximum Junction-to-Ambient $\text{\textcircled{3}}$	—	50	$^\circ\text{C}/\text{W}$

Electrical Characteristics @ T_J = 25°C (unless otherwise specified)

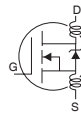
	Parameter	Min.	Typ.	Max.	Units	Conditions
V _{(BR)DSS}	Drain-to-Source Breakdown Voltage	30	—	—	V	V _{GS} = 0V, I _D = 250μA
ΔV _{(BR)DSS/ΔT_J}	Breakdown Voltage Temp. Coefficient	—	0.024	—	V/°C	Reference to 25°C, I _D = 1mA
R _{DS(ON)}	Static Drain-to-Source On-Resistance	—	—	0.022	Ω	V _{GS} = 10V, I _D = 4.0A ③
		—	—	0.035		V _{GS} = 4.5V, I _D = 3.4A ③
V _{GS(th)}	Gate Threshold Voltage	1.0	—	—	V	V _{DS} = V _{GS} , I _D = 250μA
g _{fs}	Forward Transconductance	8.4	—	—	S	V _{DS} = 15V, I _D = 4.0A
I _{DSS}	Drain-to-Source Leakage Current	—	—	1.0	μA	V _{DS} = 24V, V _{GS} = 0V
		—	—	25		V _{DS} = 24V, V _{GS} = 0V, T _J = 125°C
I _{GSS}	Gate-to-Source Forward Leakage	—	—	100	nA	V _{GS} = 20V
	Gate-to-Source Reverse Leakage	—	—	-100		V _{GS} = -20V
Q _g	Total Gate Charge	—	—	57	nC	I _D = 4.0A
Q _{gs}	Gate-to-Source Charge	—	—	6.8		V _{DS} = 24V
Q _{gd}	Gate-to-Drain ("Miller") Charge	—	—	18		V _{GS} = 10V, See Fig. 6 and 12 ③
t _{d(on)}	Turn-On Delay Time	—	10	—	ns	V _{DD} = 15V
t _r	Rise Time	—	37	—		I _D = 4.0A
t _{d(off)}	Turn-Off Delay Time	—	42	—		R _G = 6.0Ω
t _f	Fall Time	—	40	—		R _D = 3.7Ω, See Fig. 10 ③
L _D	Internal Drain Inductance	—	2.5	—	nH	Between lead tip and center of die contact 
L _S	Internal Source Inductance	—	4.0	—		
C _{iss}	Input Capacitance	—	1200	—	pF	V _{GS} = 0V
C _{oss}	Output Capacitance	—	450	—		V _{DS} = 25V
C _{rss}	Reverse Transfer Capacitance	—	160	—		f = 1.0MHz, See Fig. 5

Source-Drain Ratings and Characteristics

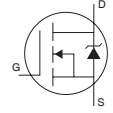
	Parameter	Min.	Typ.	Max.	Units	Conditions
I _S	Continuous Source Current (Body Diode)	—	—	3.1	A	MOSFET symbol showing the integral reverse p-n junction diode. 
I _{SM}	Pulsed Source Current (Body Diode) ①	—	—	34		
V _{SD}	Diode Forward Voltage	—	—	1.0	V	T _J = 25°C, I _S = 2.0A, V _{GS} = 0V ③
t _{rr}	Reverse Recovery Time	—	52	78	ns	T _J = 25°C, I _F = 4.0A
Q _{rr}	Reverse Recovery Charge	—	93	140	nC	di/dt = 100A/μs ③
t _{on}	Forward Turn-On Time	Intrinsic turn-on time is negligible (turn-on is dominated by L _S +L _D)				

Notes:

- ① Repetitive rating; pulse width limited by max. junction temperature. (See fig. 11)
- ② I_{SD} ≤ 4.0A, di/dt ≤ 180A/μs, V_{DD} ≤ V_{(BR)DSS}, T_J ≤ 150°C
- ③ Pulse width ≤ 300μs; duty cycle ≤ 2%.
- ④ Surface mounted on FR-4 board, t ≤ 10sec.

TYPICAL CHARACTERISTICS (25 °C, unless otherwise noted)

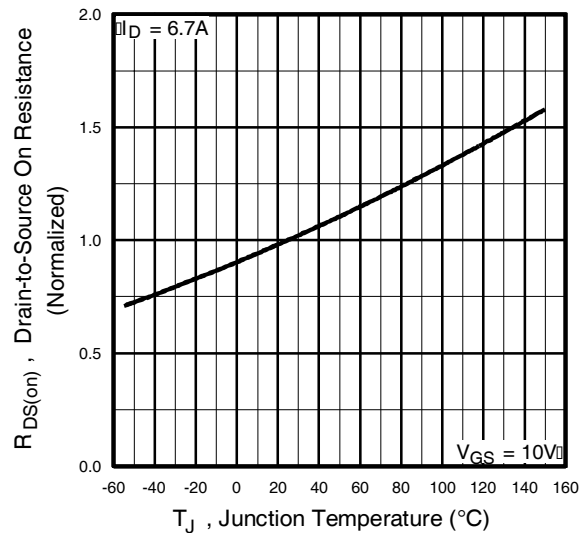
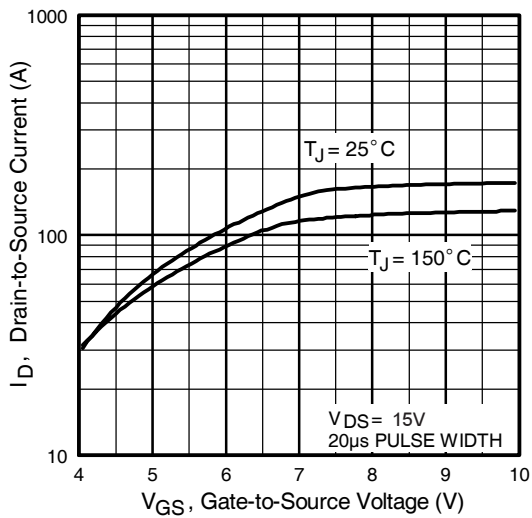
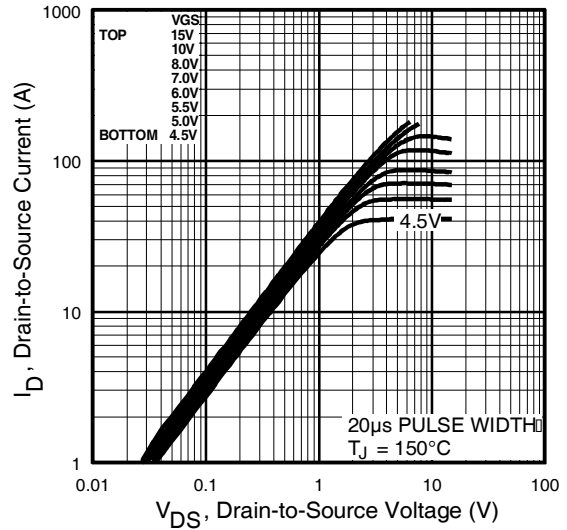
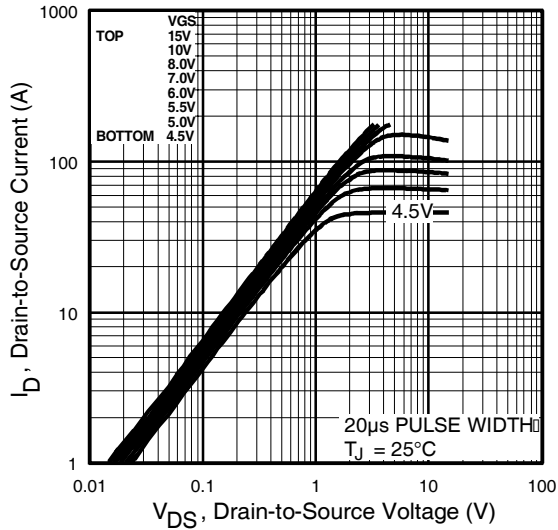

TYPICAL CHARACTERISTICS (25 °C, unless otherwise noted)

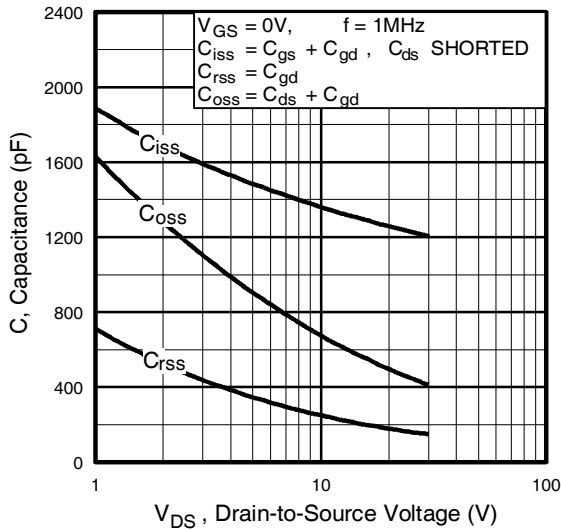

Fig 5. Typical Capacitance Vs. Drain-to-Source Voltage

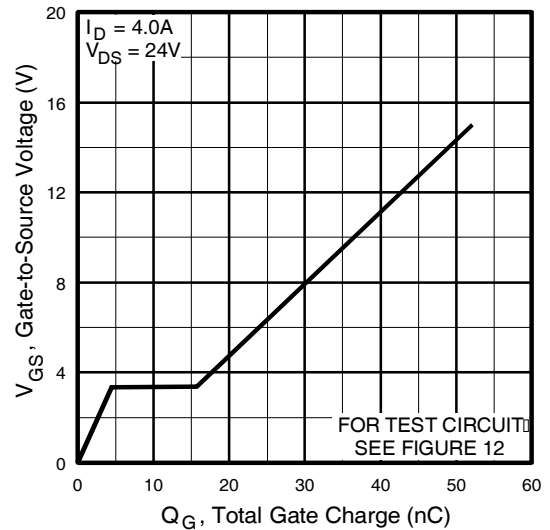

Fig 6. Typical Gate Charge Vs. Gate-to-Source Voltage

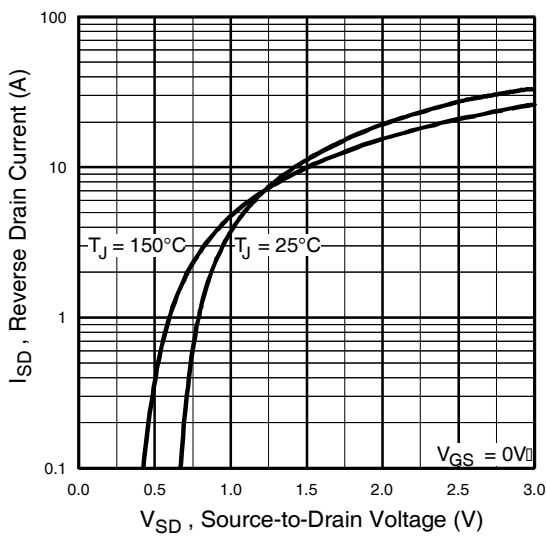

Fig 7. Typical Source-Drain Diode Forward Voltage

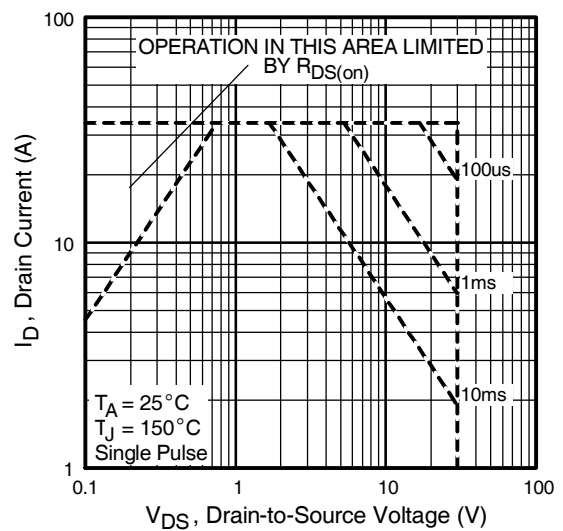

Fig 8. Maximum Safe Operating Area

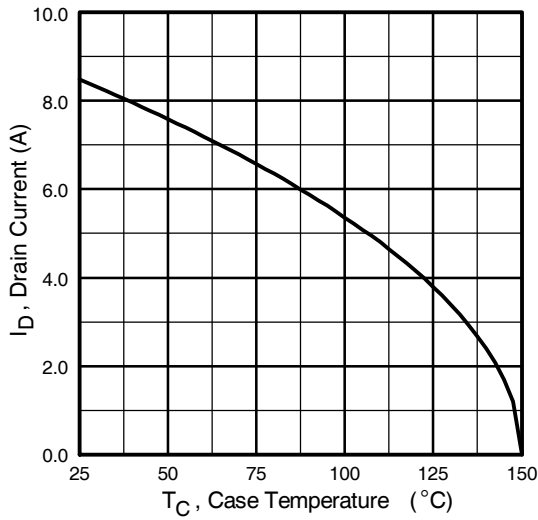

Fig 9. Maximum Drain Current Vs. Ambient Temperature

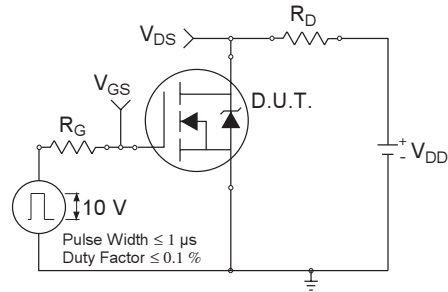

Fig 10a. Switching Time Test Circuit

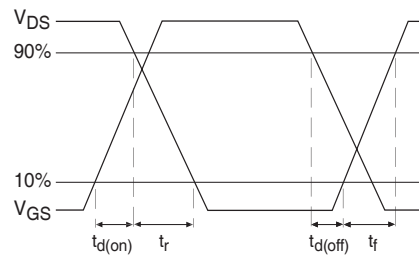

Fig 10b. Switching Time Waveforms

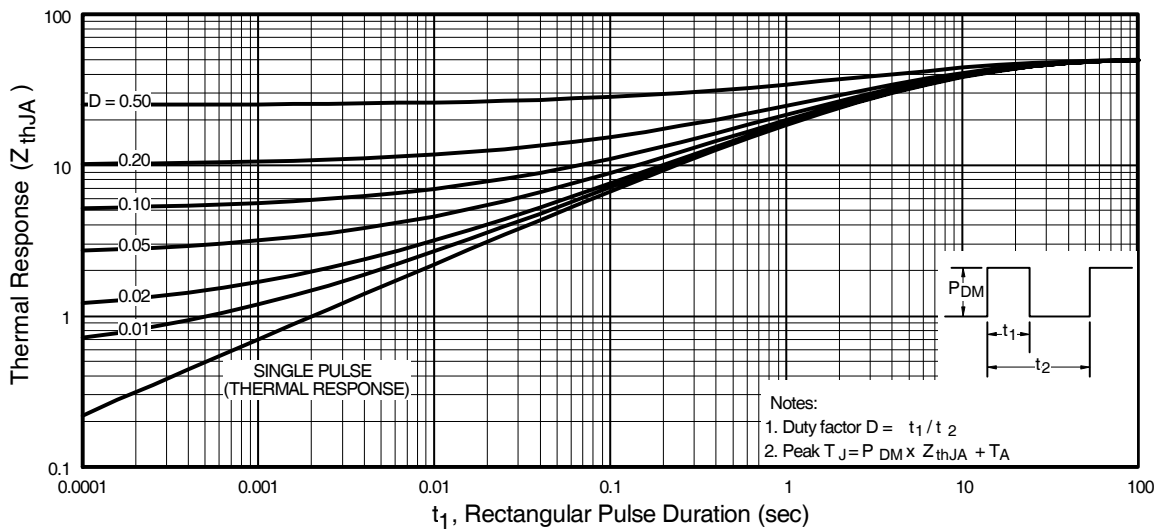

Fig 11. Maximum Effective Transient Thermal Impedance, Junction-to-Ambient

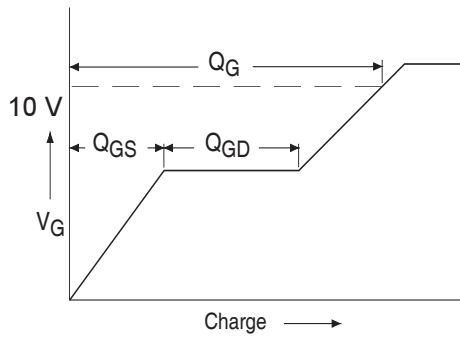

Fig 12a. Basic Gate Charge Waveform

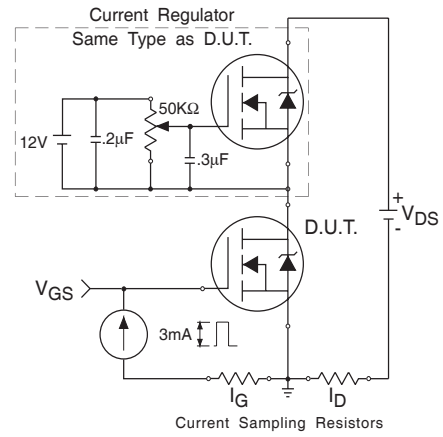
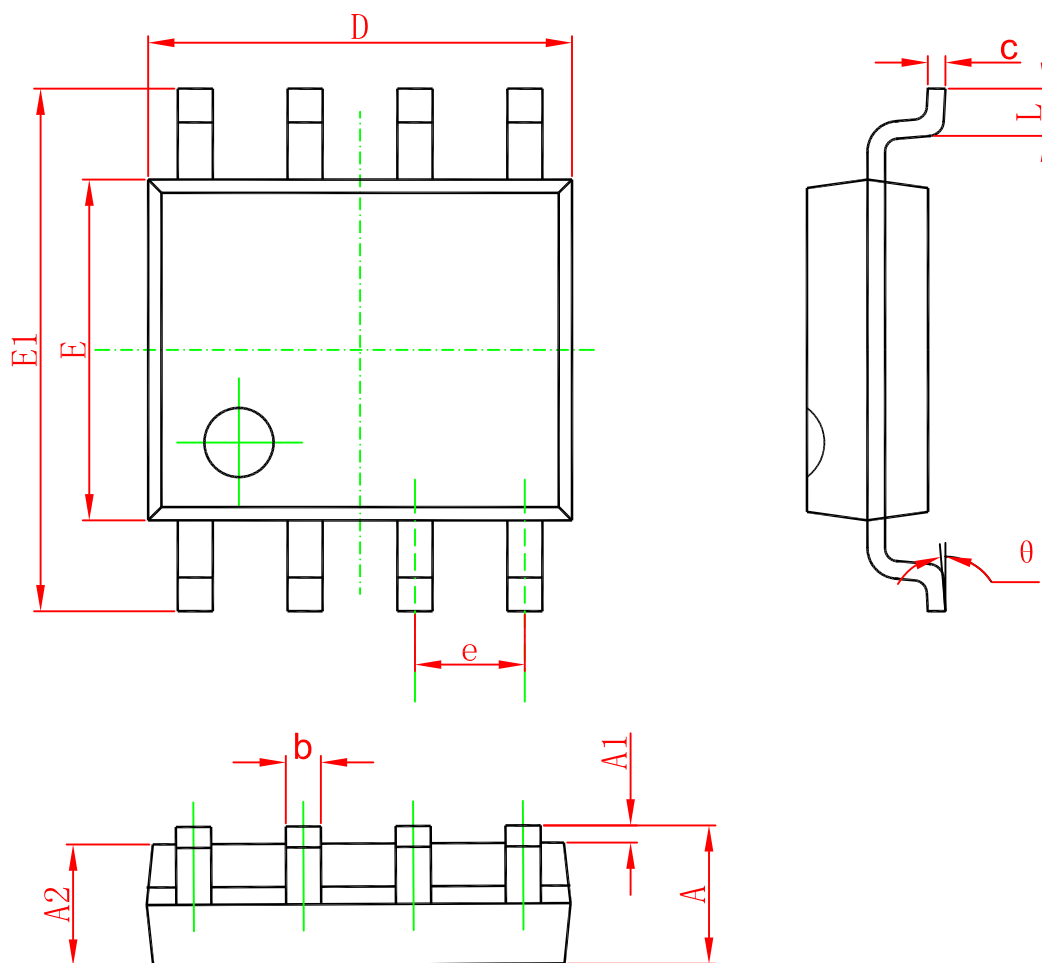

Fig 12b. Gate Charge Test Circuit

SOP-8



Symbol	Dimensions In Millimeters		Dimensions In Inches	
	Min	Max	Min	Max
A	1.350	1.750	0.053	0.069
A1	0.100	0.250	0.004	0.010
A2	1.350	1.550	0.053	0.061
b	0.330	0.510	0.013	0.020
c	0.170	0.250	0.006	0.010
D	4.700	5.100	0.185	0.200
E	3.800	4.000	0.150	0.157
E1	5.800	6.200	0.228	0.244
e	1.270(BSC)		0.050(BSC)	
L	0.400	1.270	0.016	0.050
θ	0°	8°	0°	8°

Marking

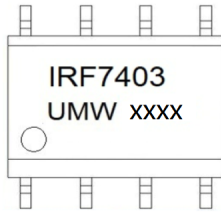

Ordering information

Order code	Package	Baseqty	Deliverymode
UMW IRF7403TR	SOP-8	3000	Tape and reel