

# 产品承认书

## SPECIFICATION FOR APPROVAL

CUSTOMER: \_\_\_\_\_

CUSTOMER P/N: \_\_\_\_\_

CND-TEK P/N. : \_\_\_\_\_

**CND-WCM0805M801-2**

DESCRIPTION: \_\_\_\_\_

**Wire Wound Type Common Mode Filter**

REF NO: \_\_\_\_\_

QTC-002

REV/NO: \_\_\_\_\_

A/0

DATE: \_\_\_\_\_

2018/08/16

ATTACHMENT:

■ SPECIFICATION

■ SAMPLE      Q'TY OF SAMPLES

PCS

	√	CUSTOMER'S SIGNATURE	REMARK
FULL APPROVED			
CONDITIONAL APPROVED			
REJECTED			



**CND-WCM0805M801-2**

**Wire Wound Type Common Mode Filter**



V1.0.3  
AUG 16,2018



深圳磁联达电子有限公司

**Shenzhen CND-TEK Electronics Co.,Ltd**

公司地址: 深圳市南山区西丽镇街道百旺社区牛城村牛城路221号505

TEL: 86-755-29016433 FAX:86- 755-27652977

Email: sales2@cd-tek.com

Http: //www.cd-tek.com



## 1. FEATURES:

- 1.1 High common mode impedance at high frequency cause excellent noise suppression performance.
- 1.2 CND-WCM0805M801-2 series realizes small size and low profile. 2.0\*1.2\*1.2 mm.
- 1.3 100% Lead(Pb) & Halogen-Free and RoHS compliant.
- 1.4 Operating Temperature range: -40~+125°C (Including self - temperature rise)
- 1.5 Storage temperature range: -40~+125°C (on board)

## 2. ELECTRICAL SPECIFICATIONS @25°C

- 2.1 Common mode Impedance ( $\Omega$ ): 800 $\pm$ 25%
- 2.2 Test Frequency (MHz) :100
- 2.3 DCResistance ( $\Omega$ ) max: 0.88
- 2.4 Rated Current (mA)max: 300
- 2.5 Rated Volt.(Vdc)max: 50
- 2.6 Withstand Volt. (Vdc) max:125
- 2.7 IR ( $\Omega$ ) min: 10M

DRAWN BY:	CHECKED BY:	APPROVED BY:	CUSTOMER:
zouwenqiang	Liyonghua	wangshengli	PART NO. : CND-WCM0805M801-2
 深圳磁联达电子有限公司			REV. : A0
			PAGE: 1 OF 7

### 3. SCHEMATICS:

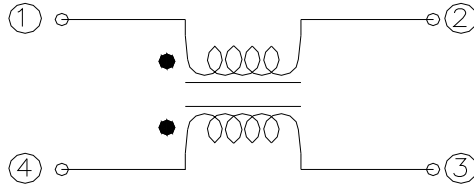

### 4. DIMENSIONS & MARKING:

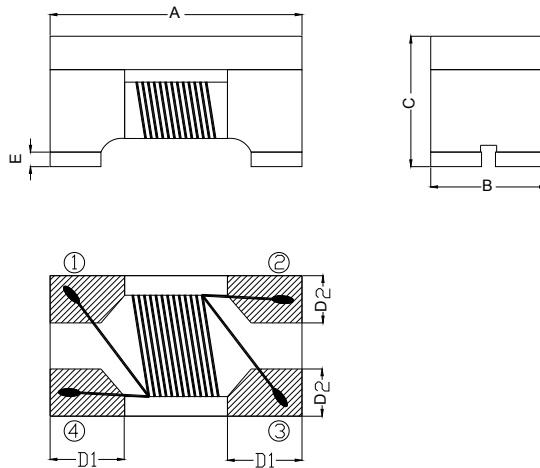

Series	A(mm)	B(mm)	C(mm)	D1(mm)	D2(mm)	E(mm)
2012F2SF	2.0±0.2	1.2±0.2	1.2±0.2	0.50±0.1	0.51±0.1	0.15±0.1

DRAWN BY:	CHECKED BY:	APPROVED BY:	CUSTOMER:
zouwenqiang	Liyonghua	wangshengli	PART NO. :CND-WCM0805M801-2
 深圳磁联达电子有限公司			REV.: A1
			PAGE: 2 OF 7

## 5. Typical Impedance v.s. Frequency Curve:

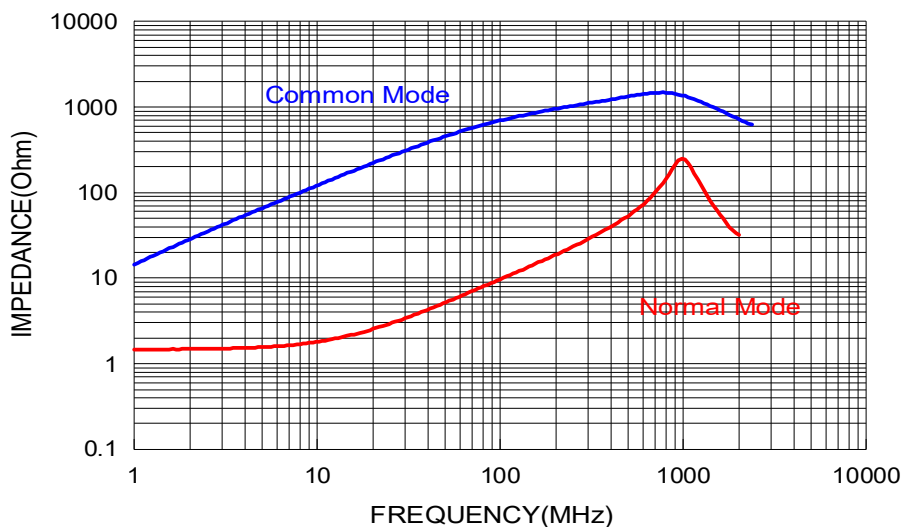

## 6. Materials:

No.	Description	Specification
a.	Upper Plate	Ferrite
b.	Core	Ferrite Core
c.	Termination	Tin (Pb Free)
d.	Wire	Enameled Copper Wire

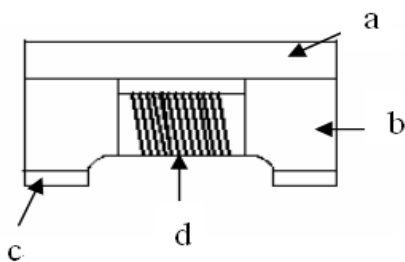



DRAWN BY:	CHECKED BY:	APPROVED BY:	CUSTOMER:
zouwenqiang	Liyonghua	wangshengli	PART NO. : CND-WCM0805M801-2

## 7、 Reliability and Test Condition:

Item	Performance	Test Condition	
Operating temperature	-40~+125 °C (Including self - temperature rise)		
Storage temperature	-40~+125°C (on board)		
<b>Electrical Performance Test</b>			
Z(common mode)	Refer to standard electrical characteristics list.	Agilent-4291A+ Agilent -16197A	
DCR		Agilent-4338B	
I.R.		Agilent4339	
Temperature Rise Test	Rated Current < 1A $\Delta T$ 20°C Max Rated Current $\geq$ 1A $\Delta T$ 40°C Max	1.Applied the allowed DC current. 2.Temperature measured by digital surface thermometer	
<b>Reliability Test</b>			
Life Test	Appearance : No damage. Inductance : within $\pm$ 10% of initial value Impedance : within $\pm$ 15% of initial value RDC :within $\pm$ 15% of initial value and shall not exceed the specification value	Preconditioning: Run through IR reflow for 2 times.( IPC/JEDEC J-STD-020DClassification Reflow Profiles) Temperature: 125 $\pm$ 2°C Applied current: rated current Duration: 1000 $\pm$ 12hrs Measured at room temperature after placing for 24 $\pm$ 2 hrs	
Load Humidity		Preconditioning: Run through IR reflow for 2 times.( IPC/JEDEC J-STD-020DClassification Reflow Profiles Humidity: 85 $\pm$ 2 % R.H, Temperature: 85°C $\pm$ 2°C Duration: 1000hrs Min. with 100% rated current Measured at room temperature after placing for 24 $\pm$ 2 hrs	
Moisture Resistance		Preconditioning: Run through IR reflow for 2 times.( IPC/JEDEC J-STD-020DClassification Reflow Profiles 1. Baked at50°C for 25hrs, measured at room temperature after placing for 4 hrs. 2. Raise temperature to 65 $\pm$ 2°C 90-100%RH in 2.5hrs, and keep 3 hours, cool down to 25°C in 2.5hrs. 3. Raise temperature to 65 $\pm$ 2°C 90-100%RH in 2.5hrs, and keep 3 hours, cool down to 25°C in 2.5hrs,keep at 25°C for 2 hrs then keep at -10°C for 3 hrs 4. Keep at 25°C 80-100%RH for 15min and vibrate at the frequency of 10 to 55 Hz to 10 Hz, measure at room temperature after placing for 1~2 hrs.	
Thermal shock		Preconditioning: Run through IR reflow for 2 times.( IPC/JEDECJ-STD-020DClassification Reflow Profiles Condition for 1 cycle Step1: -40 $\pm$ 2°C 30 $\pm$ 5min Step2: 25 $\pm$ 2°C $\leq$ 0.5min Step3: 125 $\pm$ 2°C 30 $\pm$ 5min Number of cycles: 500 Measured at room temperature after placing for 24 $\pm$ 2 hrs	
Vibration		Oscillation Frequency: 10~2K~10Hz for 20 minutes Equipment: Vibration checker Total Amplitude:1.52mm $\pm$ 10% Testing Time : 12 hours(20 minutes, 12 cycles each of 3 orientations).	
REPORT BY:	CHECKED BY:	APPROVED BY:	CUSTOMER:
zouwenqiang	Liyonghua	wangshengli	PART NO. : CND-WCM0805M801-2
 深圳磁联达电子有限公司			REV. : A
			PAGE: 4 OF 7

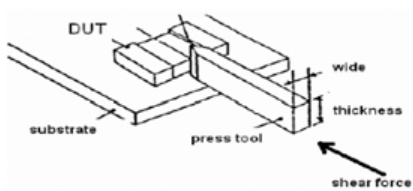
## 7、 Reliability and Test Condition :

Item		Performance	Test Condition										
Shock		Appearance: No damage. Inductance: within±10% of initial value Impedance : within±15% of initial value	Type	Peak value (g · s)	Normal duration (D) (ms)	Wave form	Velocity change (Vi)ft/sec						
			SMD	50	11	Half-sine	11.3						
			Lead	50	11	Half-sine	11.3						
			shocks in each direction along 3 perpendicular axes.										
Bending		RDC: within ±15% of initial value and shall not exceed the specification value	Shall be mounted on a FR4 substrate of the following dimensions: >=0805:40x100x1.2mm <0805:40x100x0.8mm Bending depth: >=0805inch(2012mm):1.2mm <0805 inch(2012mm):0.8mm duration of 10 sec.										
Soderability		More than 95% of the terminal electrode should be covered with solder.	Preheat: 150°C,60sec.。 Solder: Sn96.5% Ag3% Cu0.5% Temperature: 245±5°C。 Flux for lead free: Rosin. 9.5%。 Dip time: 4±1sec。 Depth: completely cover the termination										
Resistance to Soldering Heat			<b>Number of heat cycles: 1</b> <table border="1"> <thead> <tr> <th>Temperature (°C)</th> <th>Time(s)</th> <th>Temperature ramp/immersion and emersion rate</th> </tr> </thead> <tbody> <tr> <td>260 ±5(solder temp)</td> <td>10 ±1</td> <td>25mm/s ±6 mm/s</td> </tr> </tbody> </table>					Temperature (°C)	Time(s)	Temperature ramp/immersion and emersion rate	260 ±5(solder temp)	10 ±1	25mm/s ±6 mm/s
Temperature (°C)	Time(s)	Temperature ramp/immersion and emersion rate											
260 ±5(solder temp)	10 ±1	25mm/s ±6 mm/s											
Terminal Strength		Appearance : No damage. Inductance : within±10% of initial value Impedance : within±15% of initial value RDC : within ±15% of initial value and shall not exceed the specification value	Preconditioning:Run through IR reflow for 2 times.( IPC/JEDEC J-STD-020DClassification Reflow Profiles With the component mounted on a PCB with the device to be tested, apply a force (>0805 inch(2012mm):1kg , <=0805 inch(2012mm):0.5kg)to the side of a device being tested. This force shall be applied for 60 +1 seconds. Also the force shall be applied gradually as not to apply a shock to the component being tested. 										
REPORT BY:	CHECKED BY:	APPROVED BY:	CUSTOMER:										
zouwenqiang	Liyonghua	wangshengli	PART NO. :CND-WCM0805M801-2										
 深圳磁联达电子有限公司			REV. : A0										
			PAGE: 5 OF 7										



## 8、Soldering and Mounting: 8.1 Recommended PC Board Pattern

L(mm)	2.60
H(mm)	1.40
G1(mm)	1.25
G2(mm)	0.45

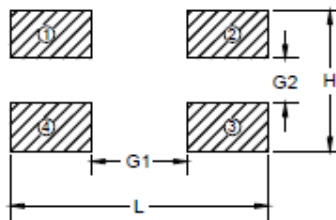

PC board should be designed so that products can prevent damage from mechanical stress when warping the board. Products shall be positioned in the sideway direction to against the mechanical stress to prevent failure.

### 8.2 Soldering

Mildly activated rosin fluxes are preferred. CND-TEK terminations are suitable for all wave and re-flow soldering systems. If hand soldering cannot be avoided, the preferred technique is the utilization of hot air soldering tools.

#### 8-2.1 Lead Free Solder re-flow:

Recommended temperature profiles for re-flow soldering in Figure 1.

#### 8-2.2 Soldering Iron(Figure 2):

Products attachment with a soldering iron is discouraged due to the inherent process control limitations. In the event that a soldering iron must be employed the following precautions are recommended.

Preheat circuit and products to 150°C ·Never contact the ceramic with the iron tip ·Use a 20 watt soldering iron

with tip diameter of 1.0mm

355 tip temperature (max) 1.0mm tip diameter (max) Limit soldering time to 4~5 sec.

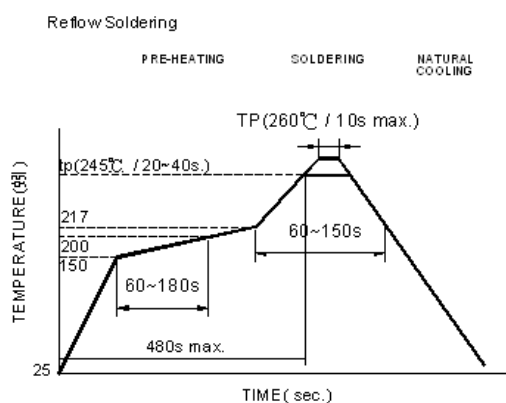

Reflow times: 3 times max.

Fig.1

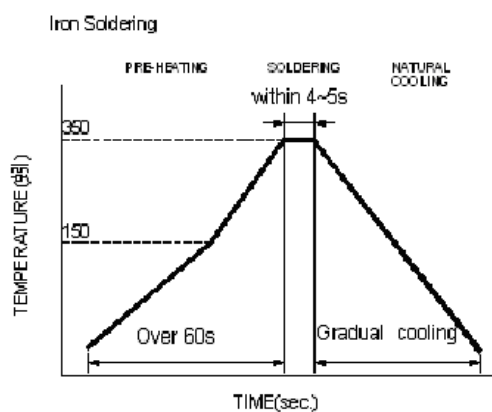

Iron Soldering times: 1 times max.

Fig.2

REPORT BY:

CHECKED BY:

APPROVED BY:

CUSTOMER:

zouwenqiang

Liyonghua

wangshengli

PART NO. : CND-WCM0805M801-2

## 9、Packaging Information:

### 9.1 Reel Dimension

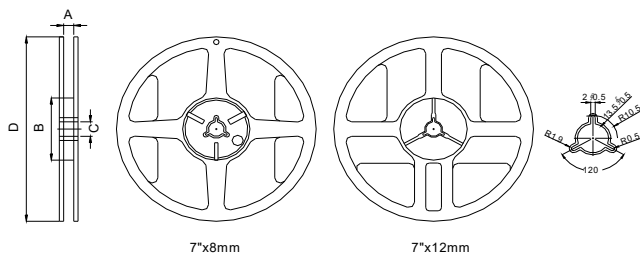

Type	A(mm)	B(mm)	C(mm)	D(mm)
7"x8mm	9.0±0.5	60±2	13.5±0.5	178±2

### 9.2 Tape Dimension / 8mm

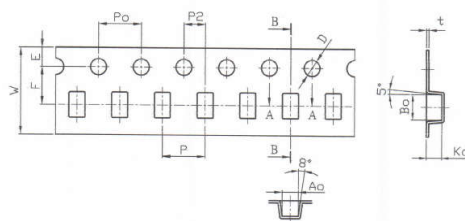

Series	W(mm)	P(mm)	E(mm)	F(mm)	P2(mm)	D(mm)	P0(mm)	A0(mm)	B0(mm)	K0(mm)	t(mm)
WCM0805M801-2	8.00±0.10	4.00±0.10	1.75±0.10	3.50±0.05	2.00±0.05	1.50+0.10/-0.00	4.00±0.10	1.50±0.10	2.35±0.10	1.45±0.10	0.28±0.05

### 9.3 Packaging Quantity

Chip size	Chip/Reel	Inner Box	Middle Box	Carton
CND-WCM0805M801-2	2000	10000	50000	100000

### 9.4 Tearing Off Force

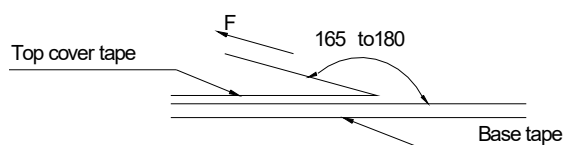

The force for tearing off cover tape is 15 to 80 grams in the arrow direction under the following conditions.

Room Temp. (°C)	Room Humidity (%)	Room atm (hPa)	Tearing Speed (mm/min)
5~35	45~85	860~1060	300

#### Application Notice:

- Storage Conditions  
To maintain the solderability of terminal electrodes:
  1. CND-TEK products meet IPC/JEDEC J-STD-020D standard-MSL, level 1.
  2. Temperature and humidity conditions: Less than 40°C and 60% RH.
  3. . Remmended products should be used within 12 months form the time of delivery.
  4. The packaging material should be kept where no chlorine or sulfur exists in the air.
- Transportation
  1. Products should be handled with care to avoid damage or contamination from perspiration and skin oils.
  2. The use of tweezers or vacuum pick up is strongly recommended for individual components.
  3. Bulk handling should ensure that abrasion and mechanical shock are minimized.

REPORT BY:	CHECKED BY:	APPROVED BY:	CUSTOMER:
zouwenqiang	Liyonghua	wangshengli	PART NO. : CND-WCM0805M801-2
 深圳磁联达电子有限公司			REV. : A0
			PAGE: 7 OF 7