

**Features**

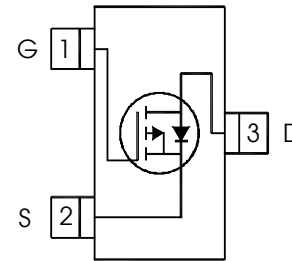
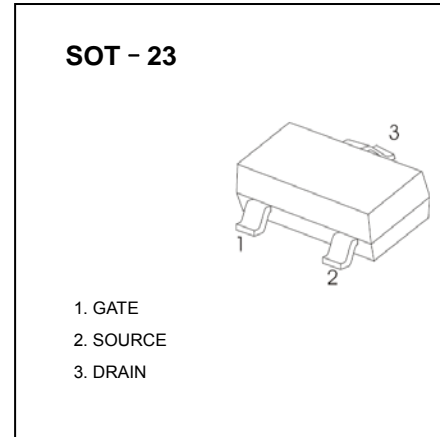
- $V_{DS} (V) = -20V$
- $R_{DS(ON)} < 54m\Omega$  ( $V_{GS} = 4.5V$ )
- $R_{DS(ON)} < 95m\Omega$  ( $V_{GS} = 2.5V$ )

**Application(s)**

- System/Load Switch

**Benefits**

- Multi-vendor compatibility
- Easier manufacturing
- Environmentally friendly
- Increased reliability



**Absolute Maximum Ratings**

Symbol	Parameter	Max.	Units
$V_{DS}$	Drain-Source Voltage	-20	V
$I_D @ T_A = 25^\circ C$	Continuous Drain Current, $V_{GS} @ -4.5V$	-4.3	A
$I_D @ T_A = 70^\circ C$	Continuous Drain Current, $V_{GS} @ -4.5V$	-3.4	
$I_{DM}$	Pulsed Drain Current	-18	
$P_D @ T_A = 25^\circ C$	Maximum Power Dissipation	1.3	W
$P_D @ T_A = 70^\circ C$	Maximum Power Dissipation	0.8	
	Linear Derating Factor	0.01	
$V_{GS}$	Gate-to-Source Voltage	$\pm 12$	V
$T_J, T_{STG}$	Junction and Storage Temperature Range	-55 to + 150	$^\circ C$

**Thermal Resistance**

Symbol	Parameter	Typ.	Max.	Units
$R_{\theta JA}$	Junction-to-Ambient ③	—	100	$^\circ C/W$
$R_{\theta JA}$	Junction-to-Ambient ( $t < 10s$ ) ④	—	99	

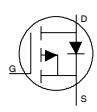
**Notes:**

- ① Repetitive rating; pulse width limited by max. junction temperature.
- ② Pulse width  $\leq 400\mu s$ ; duty cycle  $\leq 2\%$ .
- ③ Surface mounted on 1 in square Cu board

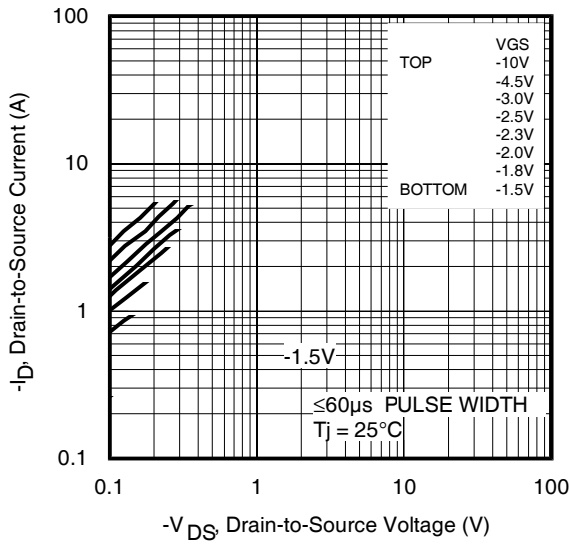
**Electric Characteristics @ T<sub>J</sub> = 25°C (unless otherwise specified)**

Symbol	Parameter	Min.	Typ.	Max.	Units	Conditions
V <sub>(BR)DSS</sub>	Drain-to-Source Breakdown Voltage	-20	—	—	V	V <sub>GS</sub> = 0V, I <sub>D</sub> = -250μA
ΔV <sub>(BR)DSS</sub> /ΔT <sub>J</sub>	Breakdown Voltage Temp. Coefficient	—	0.01	—	V/°C	Reference to 25°C, I <sub>D</sub> = -1mA
R <sub>DSON</sub>	Static Drain-to-Source On-Resistance	—	42	54	mΩ	V <sub>GS</sub> = -4.5V, I <sub>D</sub> = -4.3A ②
		—	71	95		V <sub>GS</sub> = -2.5V, I <sub>D</sub> = -3.4A ②
V <sub>GS(th)</sub>	Gate Threshold Voltage	-0.4	—	-1.1	V	V <sub>DS</sub> = V <sub>GS</sub> , I <sub>D</sub> = -10μA
I <sub>DSS</sub>	Drain-to-Source Leakage Current	—	—	1	μA	V <sub>DS</sub> = -16V, V <sub>GS</sub> = 0V
		—	—	150		V <sub>DS</sub> = -16V, V <sub>GS</sub> = 0V, T <sub>J</sub> = 125°C
I <sub>GSS</sub>	Gate-to-Source Forward Leakage	—	—	-100	nA	V <sub>GS</sub> = 12V
	Gate-to-Source Reverse Leakage	—	—	100		V <sub>GS</sub> = -12V
R <sub>G</sub>	Internal Gate Resistance	—	8.9	—	Ω	
g <sub>fs</sub>	Forward Transconductance	6.5	—	—	S	V <sub>DS</sub> = -10V, I <sub>D</sub> = -4.3A
Q <sub>g</sub>	Total Gate Charge	—	6.9	—	nC	I <sub>D</sub> = -4.3A
Q <sub>gs</sub>	Gate-to-Source Charge	—	1.0	—		V <sub>DS</sub> = -10V
Q <sub>gd</sub>	Gate-to-Drain ("Miller") Charge	—	2.9	—		V <sub>GS</sub> = -4.5V ②
t <sub>d(on)</sub>	Turn-On Delay Time	—	7.0	—	ns	V <sub>DD</sub> = -10V ②
t <sub>r</sub>	Rise Time	—	12	—		I <sub>D</sub> = -1A
t <sub>d(off)</sub>	Turn-Off Delay Time	—	34	—		R <sub>G</sub> = 6.8Ω
t <sub>f</sub>	Fall Time	—	25	—		V <sub>GS</sub> = -4.5V
C <sub>iss</sub>	Input Capacitance	—	570	—	pF	V <sub>GS</sub> = 0V
C <sub>oss</sub>	Output Capacitance	—	160	—		V <sub>DS</sub> = -16V
C <sub>rss</sub>	Reverse Transfer Capacitance	—	110	—		f = 1.0KHz

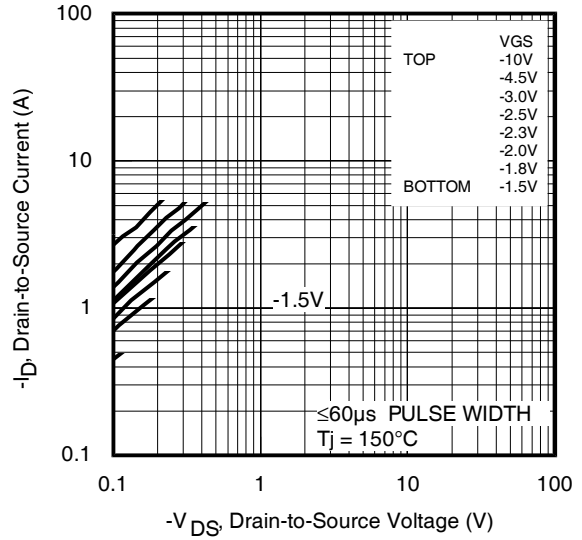
**Source - Drain Ratings and Characteristics**

Symbol	Parameter	Min.	Typ.	Max.	Units	Conditions
I <sub>S</sub>	Continuous Source Current (Body Diode)	—	—	-1.3	A	MOSFET symbol showing the integral reverse p-n junction diode. 
I <sub>SM</sub>	Pulsed Source Current (Body Diode) ①	—	—	-18		
V <sub>SD</sub>	Diode Forward Voltage	—	—	-1.2	V	T <sub>J</sub> = 25°C, I <sub>S</sub> = -4.3A, V <sub>GS</sub> = 0V ②
t <sub>rr</sub>	Reverse Recovery Time	—	21	32	ns	T <sub>J</sub> = 25°C, V <sub>R</sub> = -16V, I <sub>F</sub> = -4.3A
Q <sub>rr</sub>	Reverse Recovery Charge	—	9.0	14	nC	di/dt = 100A/μs ②

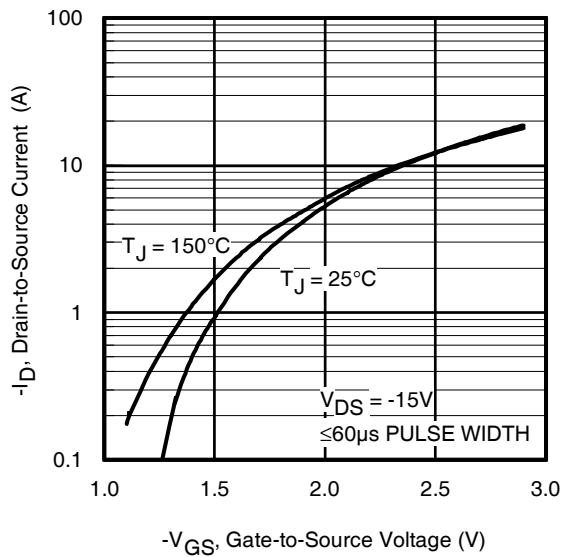
**TYPICAL CHARACTERISTICS** 25 °C, unless otherwise noted



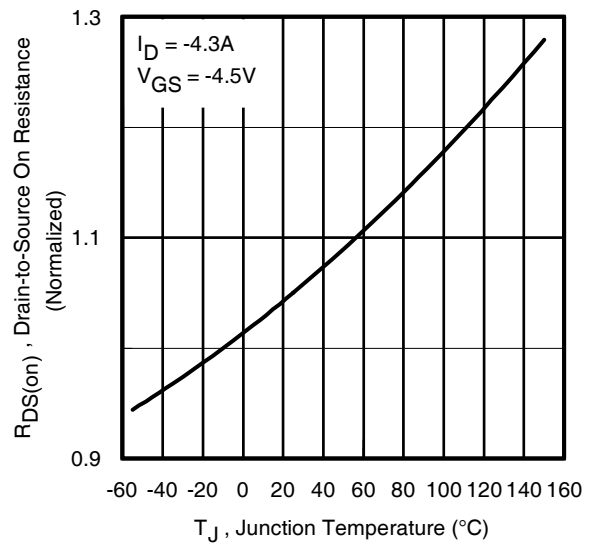
**Fig 1.** Typical Output Characteristics



**Fig 2.** Typical Output Characteristics

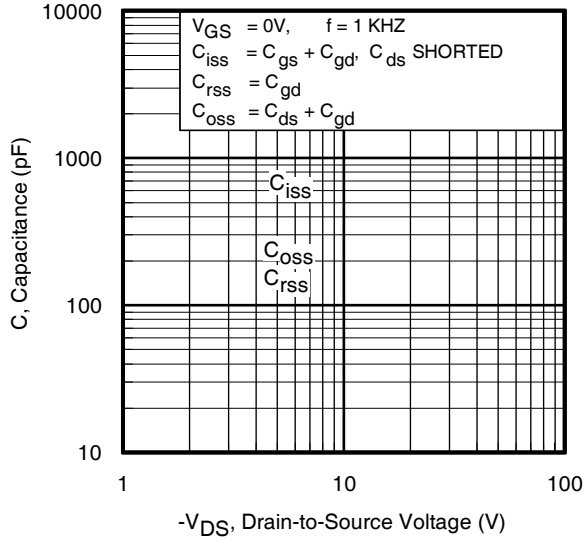


**Fig 3.** Typical Transfer Characteristics

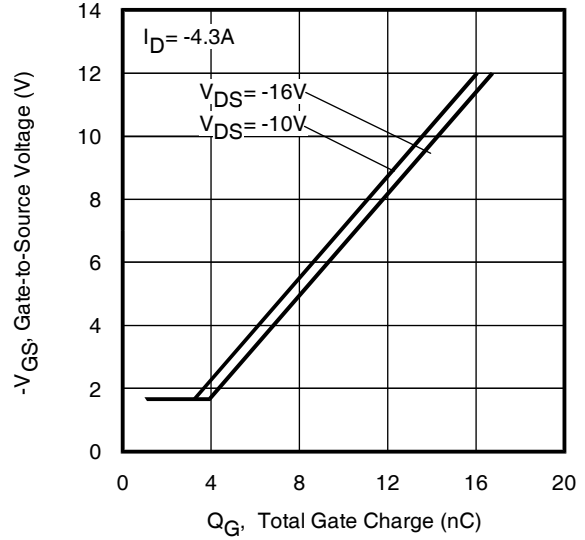


**Fig 4.** Normalized On-Resistance Vs. Temperature

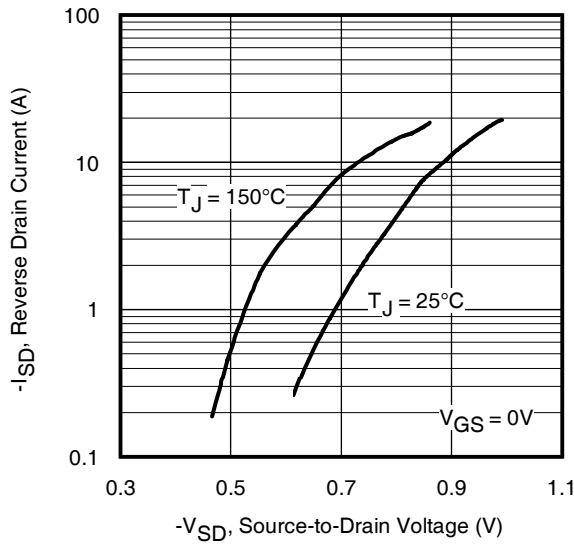
**TYPICAL CHARACTERISTICS** 25 °C, unless otherwise noted



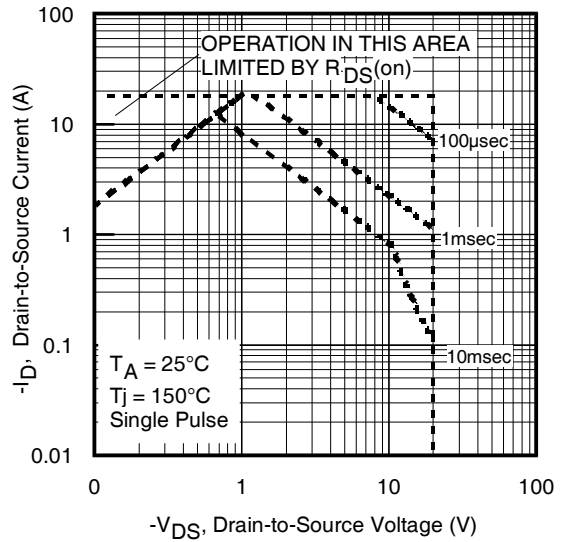
**Fig 5.** Typical Capacitance Vs. Drain-to-Source Voltage



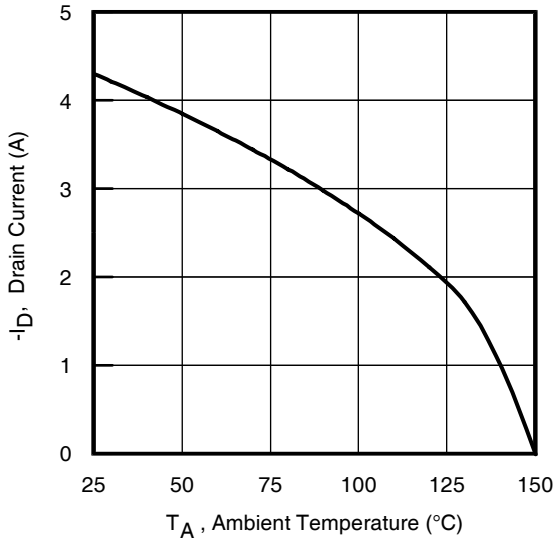
**Fig 6.** Typical Gate Charge Vs. Gate-to-Source Voltage



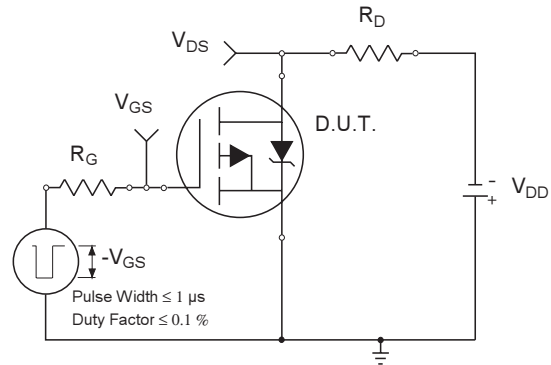
**Fig 7.** Typical Source-Drain Diode Forward Voltage



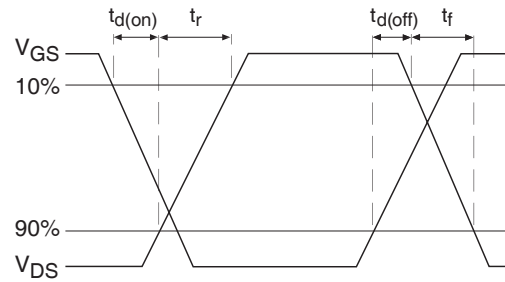
**Fig 8.** Maximum Safe Operating Area



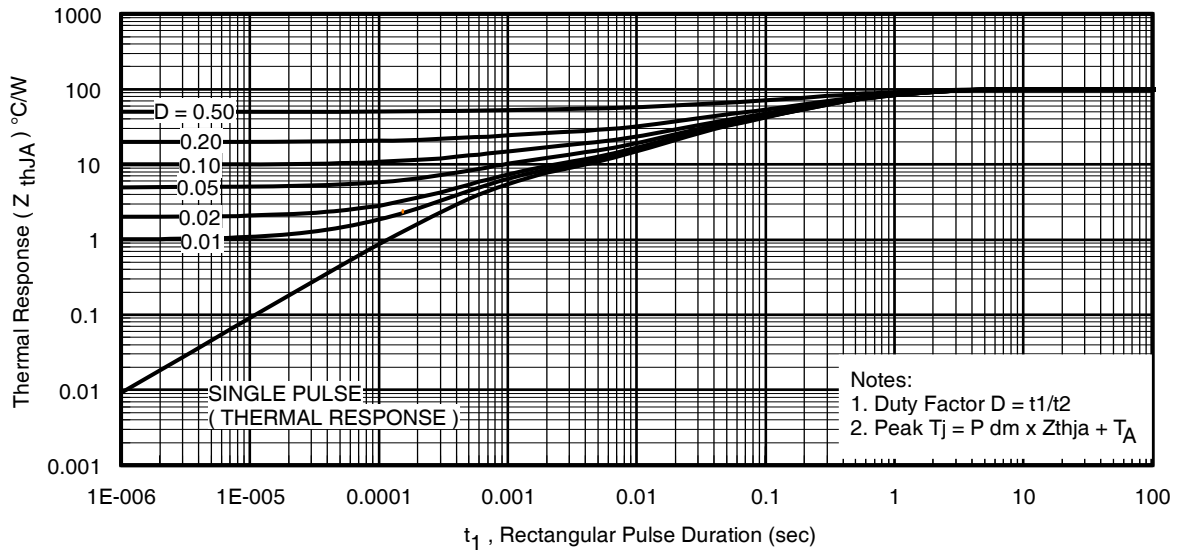
**Fig 9.** Maximum Drain Current Vs. Ambient Temperature



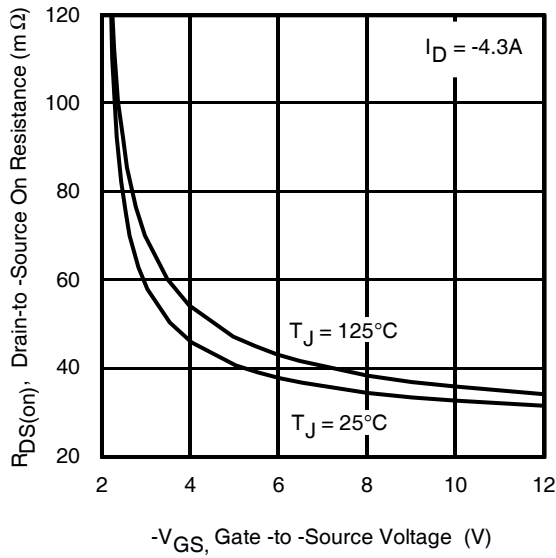
**Fig 10a.** Switching Time Test Circuit



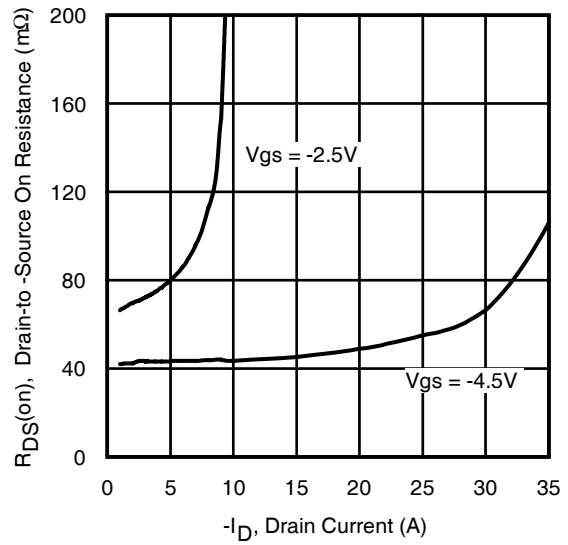
**Fig 10b.** Switching Time Waveforms



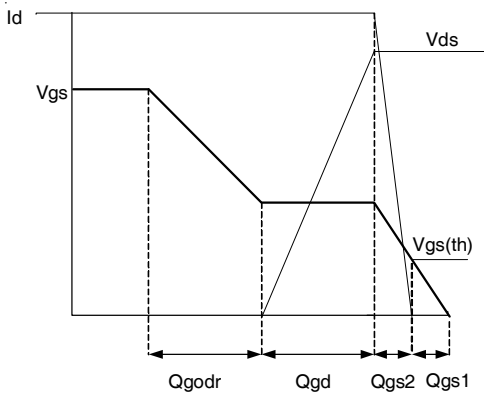
**Fig 11.** Typical Effective Transient Thermal Impedance, Junction-to-Ambient



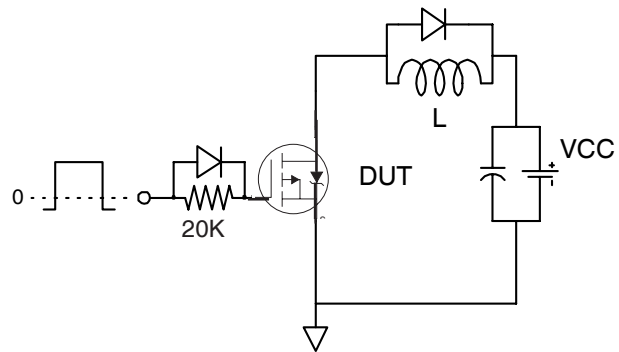
**Fig 12.** Typical On-Resistance Vs. Gate Voltage



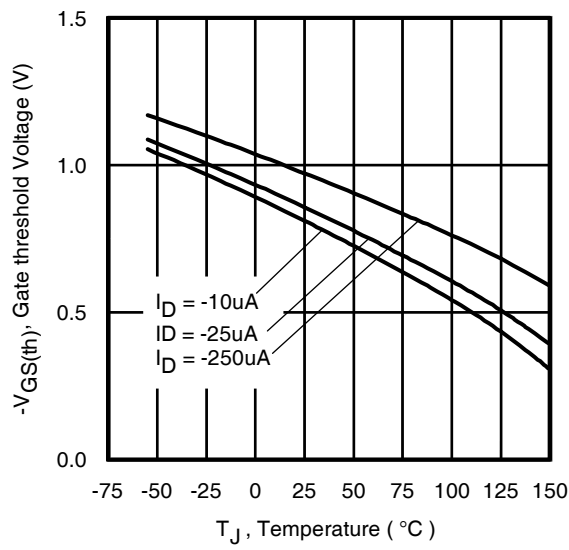
**Fig 13.** Typical On-Resistance Vs. Drain Current



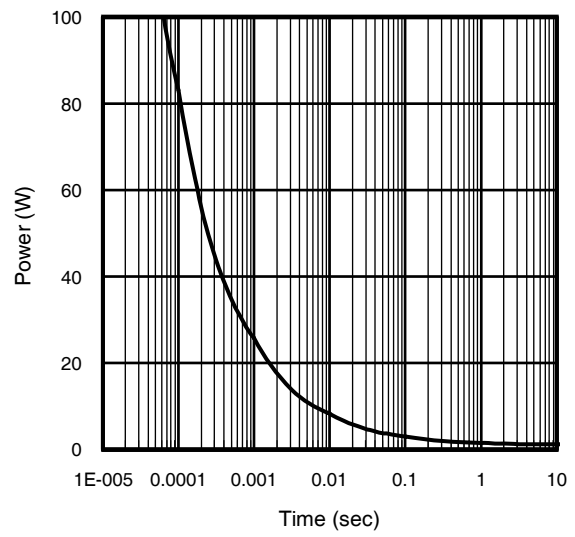
**Fig 14a.** Basic Gate Charge Waveform



**Fig 14b.** Gate Charge Test Circuit

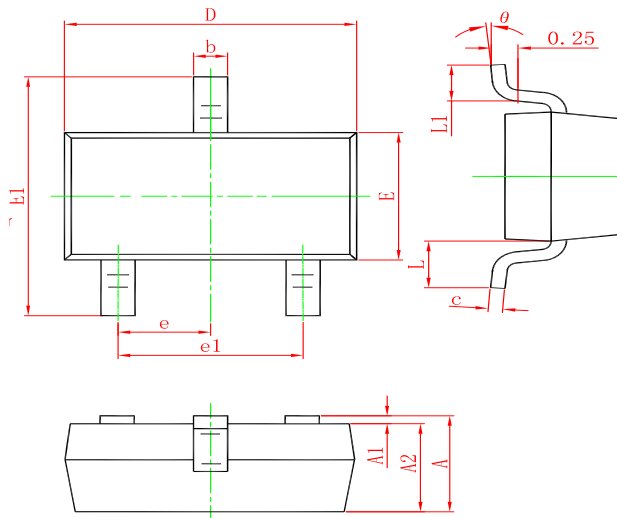


**Fig 15.** Typical Threshold Voltage Vs. Junction Temperature



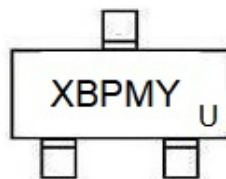
**Fig 16.** Typical Power Vs. Time

**SOT-23 PACKAGE OUTLINE DIMENSIONS**



Symbol	Dimensions In Millimeters		Dimensions In Inches	
	Min.	Max.	Min.	Max.
A	0.900	1.150	0.035	0.045
A1	0.000	0.100	0.000	0.004
A2	0.900	1.050	0.035	0.041
b	0.300	0.500	0.012	0.020
c	0.080	0.150	0.003	0.006
D	2.800	3.000	0.110	0.118
E	1.200	1.400	0.047	0.055
E1	2.250	2.550	0.089	0.100
e	0.950 TYP.		0.037 TYP.	
e1	1.800	2.000	0.071	0.079
L	0.550 REF.		0.022 REF.	
L1	0.300	0.500	0.012	0.020
θ	0°	8°	0°	8°

**Marking**



**Ordering information**

Order code	Package	Baseqty	Deliverymode
UMW IRLML2244TR	SOT-23	3000	Tape and reel