

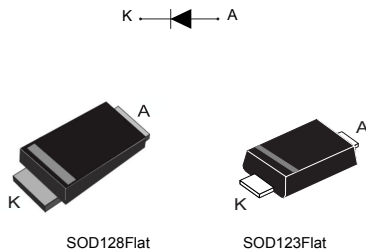

Automotive 100 V - 1 A power Schottky trench rectifier



Features

- AEC-Q101 qualified 
- PPAP capable
- Low forward voltage drop
- Low recovery charges
- Reduces conduction, reverse and switching losses
- 100% Avalanche tested in production
- Operating T_j from -40 °C to $+175\text{ °C}$
- Flat packages
- ECOPACK2 compliant



Product label



Product status link

[STPST1H100-Y](#)

Product summary

$I_{F(AV)}$	1 A
V_{RRM}	100 V
T_j (max.)	175 °C
V_F (typ.)	0.580 V

Applications

- Automotive LED lighting
- Flyback topology
- On-board DC/DC converter
- ECU power supply

Description

This 1 A, 100 V rectifier is based on ST trench technology that achieves the best-in-class V_F/I_R trade-off for a given silicon surface.

Integrated in flat and space-saving packages, this STPST1H100-Y trench, and automotive-graded device is intended to be used in high frequency miniature switched mode power supplies such as in automotive, DC/DC converters or ECU power supply. It is also adapted to freewheeling applications, OR-ring, or reverse polarity protection.

1 Characteristics

Table 1. Absolute ratings (limiting values at 25 °C, unless otherwise specified)

Symbol	Parameter		Value	Unit	
V _{RRM}	Repetitive peak reverse voltage (T _j = -40°C to +175°C)		100	V	
I _{F(AV)}	Average forward current, δ = 0.5, square wave	SOD123Flat	T _L = 155 °C	1	A
		SOD128Flat	T _L = 155 °C		
I _{FSM}	Surge non repetitive forward current	SOD123Flat	t _p = 10 ms sinusoidal	25	A
		SOD128Flat			
I _{AS}	Single pulse avalanche current ⁽¹⁾	T _j = 25°C, L = 300 μH, V _{DD} = 15 V		2	A
T _{stg}	Storage temperature range		-65 to +175	°C	
T _j	Maximum operating junction temperature range ⁽²⁾		-40 to +175	°C	

1. Please refer to [Figure 1](#) and [Figure 2](#) for the unclamped inductive switching test circuit, and waveform.
2. $(dP_{tot}/dT_j) < (1/R_{th(j-a)})$ condition to avoid thermal runaway for a diode on its own heatsink.

Table 2. Thermal resistance parameter

Symbol	Parameter		Typ. value	Unit
R _{th(j-l)}	Junction to lead	SOD123Flat	16	°C/W
		SOD128Flat	15	

For more information, please refer to the following application note:

- [AN5088](#): Rectifiers thermal management, handling and mounting recommendations

Table 3. Static electrical characteristics

Symbol	Parameter	Test conditions		Min.	Typ.	Max.	Unit
I _R ⁽¹⁾	Reverse leakage current	T _j = 125 °C	V _R = 70 V	-	0.15	0.48	mA
		T _j = 25 °C	V _R = 100 V	-		1.7	μA
		T _j = 125 °C		-	0.3	1	mA
V _F ⁽²⁾	Forward voltage drop	T _j = 25 °C	I _F = 0.5 A	-	0.545	0.610	V
		T _j = 125 °C		-	0.480	0.540	
		T _j = 25 °C	I _F = 1 A	-	0.650	0.725	
		T _j = 125 °C		-	0.580	0.635	

1. Pulse test: t_p = 5 ms, δ < 2%
2. Pulse test: t_p = 380 μs, δ < 2%

To evaluate the conduction losses, use the following equation:

$$P = 0.445 \times I_{F(AV)} + 0.190 \times I_{F(RMS)}^2$$

For more information, please refer to the following application notes related to the power losses :

- [AN604](#): Calculation of conduction losses in a power rectifier
- [AN4021](#): Calculation of reverse losses on a power diode

Figure 1. Current and voltage waveforms for avalanche energy test across D.U.T (device under test)

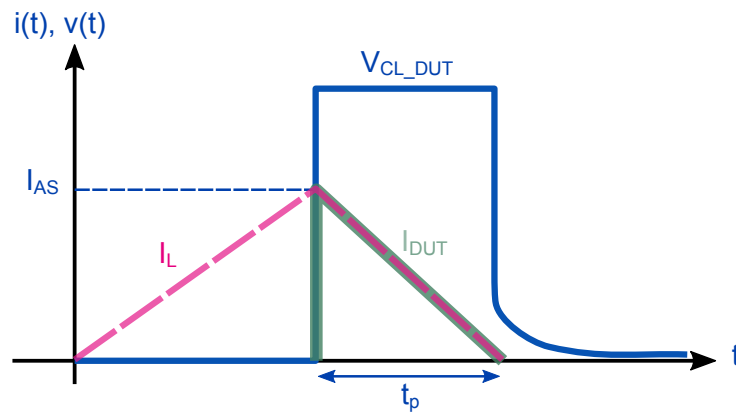
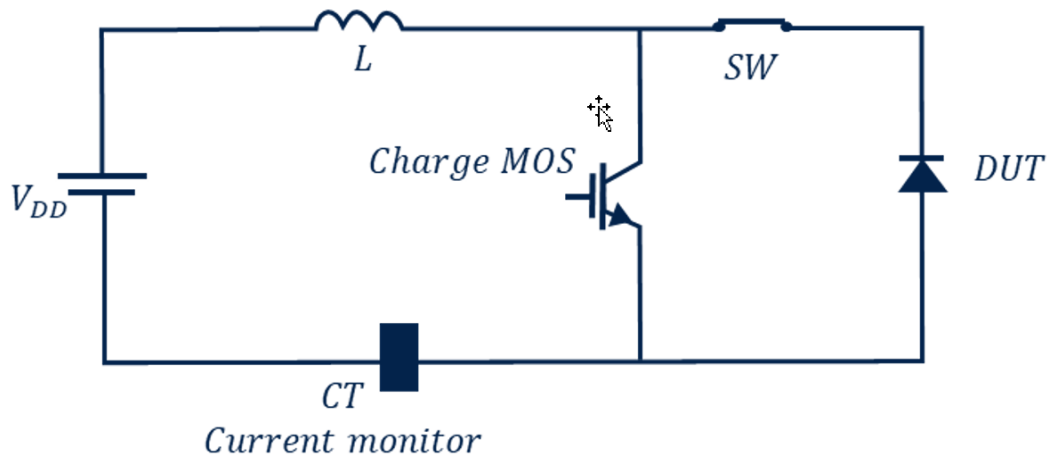

Figure 2. Unclamped Inductive Switching Test circuit



$$E_{AS} = \frac{1}{2} \times L \times I_{AS}^2 \times \left(\frac{V_{CLDUT}}{V_{CLDUT} - V_{DD}} \right) \cong \frac{1}{2} \times L \times I_{AS}^2$$

$$t_p = \left(\frac{L \times I_{AS}}{V_{CLDUT} - V_{DD}} \right)$$

1.1 Characteristics (curves)

Figure 3. Average forward current versus lead temperature ($\delta = 0.5$)

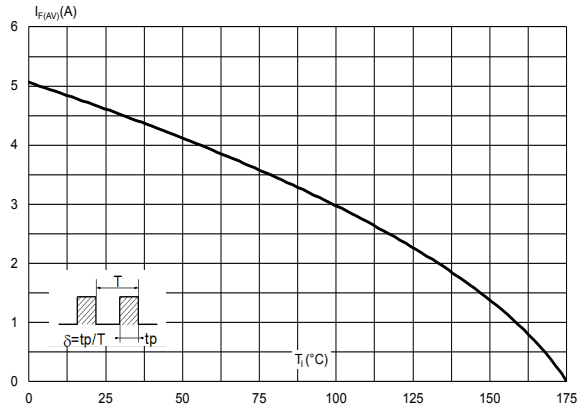

Figure 4. Relative variation of thermal impedance junction to lead versus pulse duration (SOD123Flat)

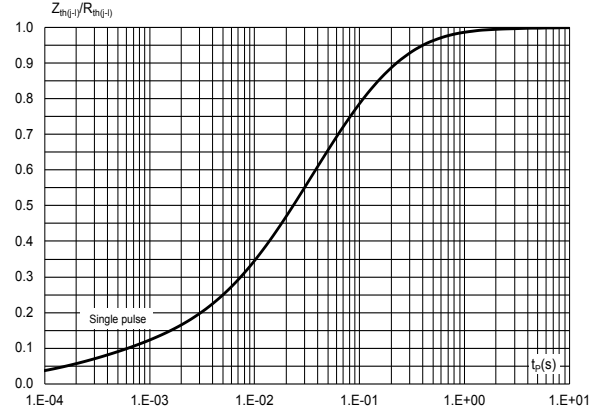

Figure 5. Relative variation of thermal impedance junction to lead versus pulse duration (SOD128Flat)

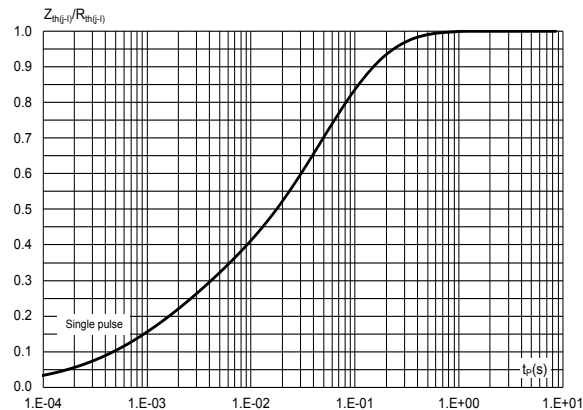

Figure 6. Reverse leakage current versus reverse voltage applied (typical values)

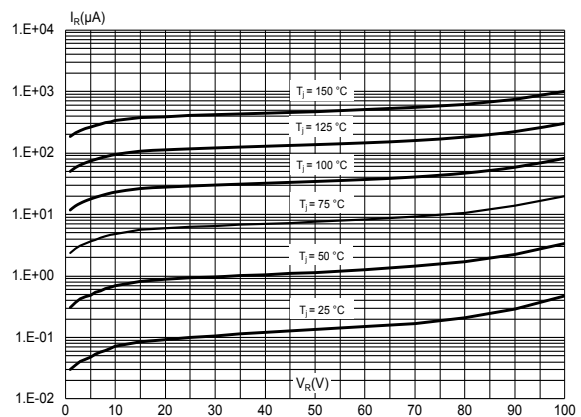

Figure 7. Junction capacitance versus reverse voltage applied (typical values)

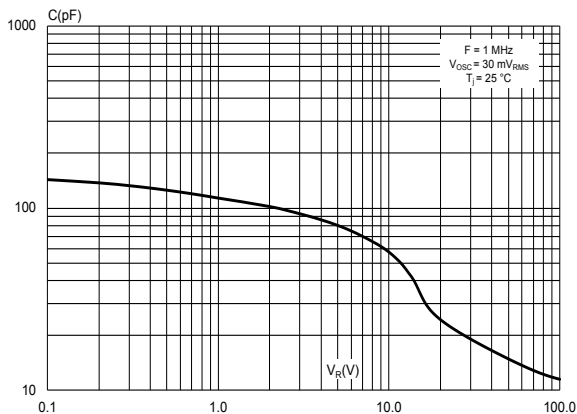

Figure 8. Forward voltage drop versus forward current (typical values)

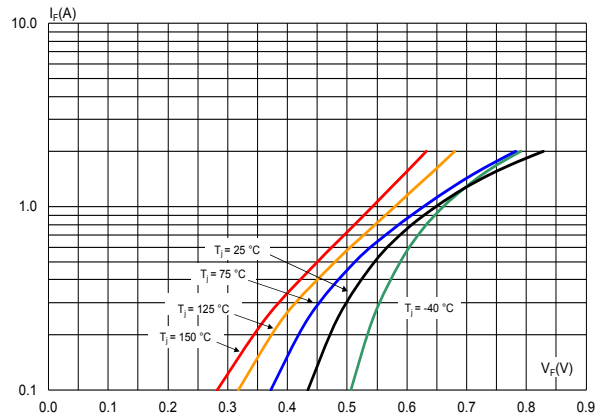

Figure 9. Thermal resistance junction to ambient versus copper surface under each lead (typical values, epoxy printed board FR4, $e_{Cu} = 70 \mu\text{m}$)

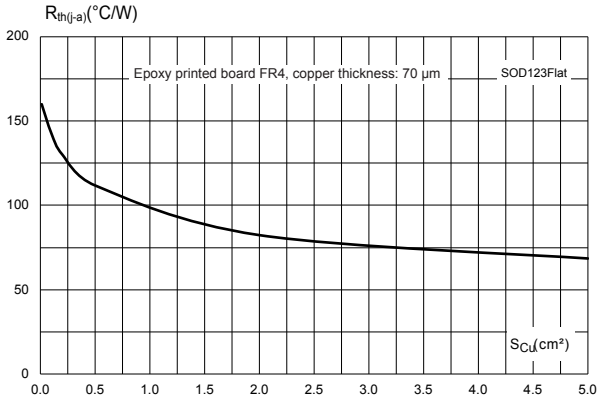
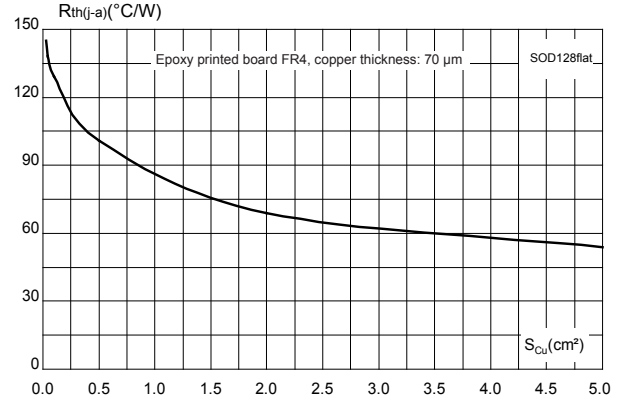

Figure 10. Thermal resistance junction to ambient versus copper surface under each lead (typical values, epoxy printed board FR4, $e_{Cu} = 70 \mu\text{m}$)



2 Package information

In order to meet environmental requirements, ST offers these devices in different grades of **ECOPACK** packages, depending on their level of environmental compliance. ECOPACK specifications, grade definitions and product status are available at: www.st.com. ECOPACK is an ST trademark.

2.1 SOD123Flat package information

Figure 11. SOD123Flat package outline

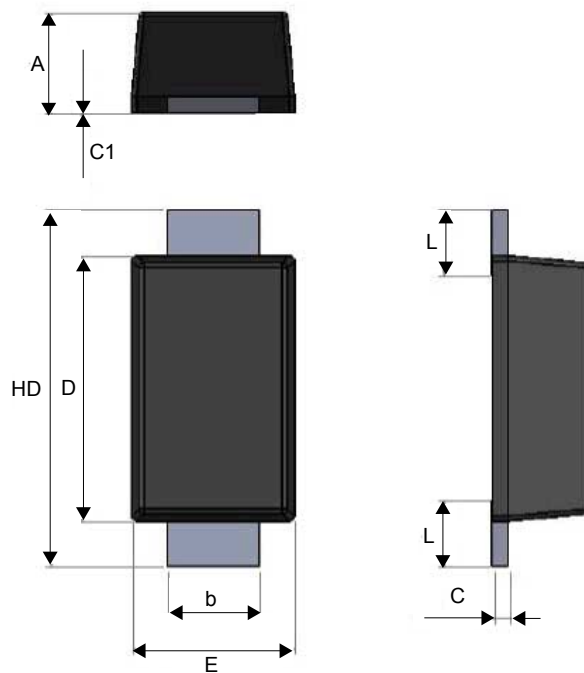

Note: This package drawing may slightly differ from the physical package. However, all the specified dimensions are guaranteed.

Table 4. SOD123Flat package mechanical data

Ref.	Dimensions					
	Millimeters			Inches (for reference only)		
	Min.	Typ.	Max.	Min.	Typ.	Max.
A	0.86	0.98	1.10	0.034	0.038	0.043
b	0.80	0.90	1.00	0.031	0.035	0.039
c	0.08	0.15	0.25	0.003	0.006	0.009
c1	0.00		0.10	0.000		0.004
D	2.50	2.60	2.70	0.098	0.102	0.106
E	1.50	1.60	1.80	0.059	0.063	0.070
HD	3.30	3.50	3.70	0.130	0.137	0.146
L	0.45	0.65	0.85	0.018	0.025	0.033

Figure 12. SOD123Flat footprint dimensions (mm)

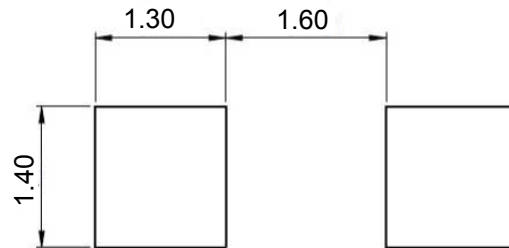

Note: For package and tape orientation, reel and inner box dimensions and tape outline please check [TN1173](#).

2.2 SOD128Flat package information

- Lead-free package

Figure 13. SOD128Flat package outline

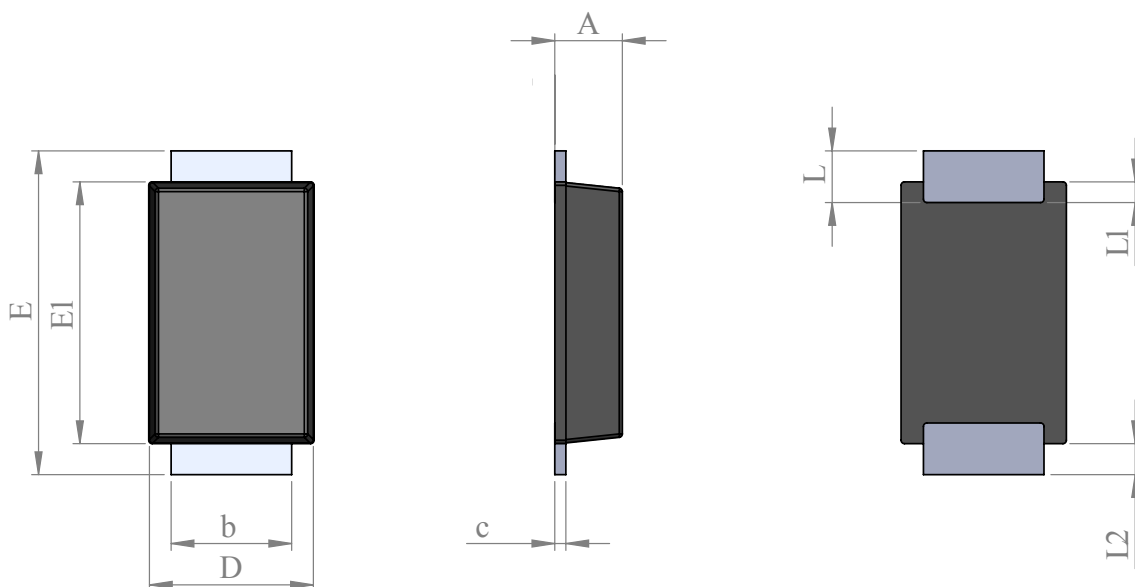

Note: This package drawing may slightly differ from the physical package. However, all the specified dimensions are guaranteed.

Table 5. SOD128Flat package mechanical data

Ref.	Dimensions			
	Millimeters		Inches	
	Min.	Max.	Min.	Max.
A	0.93	1.03	0.037	0.041
b	1.69	1.81	0.067	0.071
c	0.10	0.22	0.004	0.009
D	2.30	2.50	0.091	0.098
E	4.60	4.80	0.181	0.189
E1	3.70	3.90	0.146	0.154
L	0.55	0.85	0.026	0.033
L1	0.30 typ.		0.012 typ.	
L2	0.45 typ.		0.018 typ.	

Figure 14. SOD128Flat footprint in mm (inches)

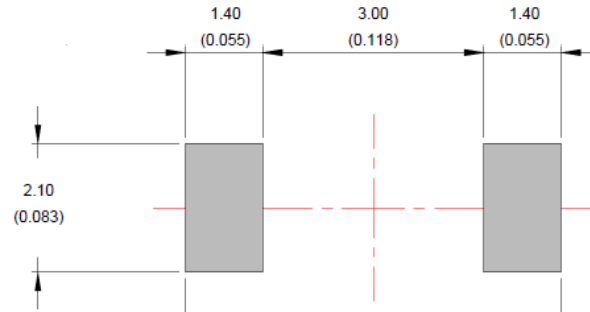

Note: For package and tape orientation, reel and inner box dimensions and tape outline please check [TN1173](#).

3 Ordering information

Table 6. Ordering information

Order code	Marking	Package	Weight	Base qty.	Delivery mode
STPST1H100ZFY	TY1	SOD123 Flat	12.5 mg	3000	Tape and reel
STPST1H100AFY	T1H1Y	SOD128Flat	26.4 mg	3000	

Revision history

Table 7. Document revision history

Date	Revision	Changes
16-Dec-2022	1	Initial release.
26-May-2023	2	Updated Figure 13 .
24-Jul-2023	3	Updated <i>Features</i> .

IMPORTANT NOTICE – READ CAREFULLY

STMicroelectronics NV and its subsidiaries (“ST”) reserve the right to make changes, corrections, enhancements, modifications, and improvements to ST products and/or to this document at any time without notice. Purchasers should obtain the latest relevant information on ST products before placing orders. ST products are sold pursuant to ST’s terms and conditions of sale in place at the time of order acknowledgment.

Purchasers are solely responsible for the choice, selection, and use of ST products and ST assumes no liability for application assistance or the design of purchasers’ products.

No license, express or implied, to any intellectual property right is granted by ST herein.

Resale of ST products with provisions different from the information set forth herein shall void any warranty granted by ST for such product.

ST and the ST logo are trademarks of ST. For additional information about ST trademarks, refer to www.st.com/trademarks. All other product or service names are the property of their respective owners.

Information in this document supersedes and replaces information previously supplied in any prior versions of this document.

© 2023 STMicroelectronics – All rights reserved