

86557-6 ✓ ACTIVE

TE Internal #: 86557-6

Pin Contact, Gold, Discrete Wire, 26 – 22 AWG Wire Size, .12 – .4 mm² Wire Size, Insulation Displacement (IDC), Phosphor Bronze, Signal

[View on TE.com >](#)



Connectors > Contacts > Connector Contacts > 2.54mm FFC Connectors Pin Contacts

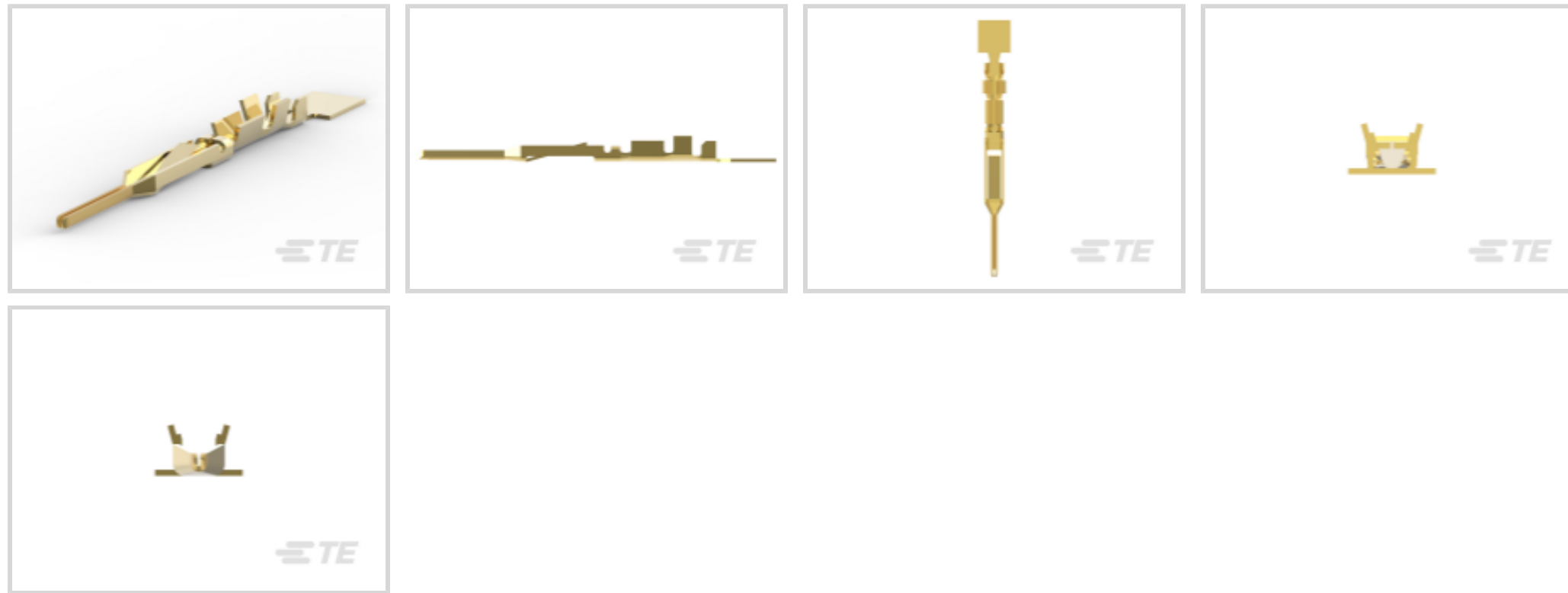

Contact Type: **Pin**

Contact Mating Area Plating Material: **Gold**

Compatible With Wire & Cable Type: **Discrete Wire**

Wire Size: **.12 – .4 mm²**

[All 2.54mm FFC Connectors Pin Contacts \(34\)](#)

Features

Configuration Features

Compatible With Wire & Cable Type	Discrete Wire
-----------------------------------	---------------

Contact Features

	15 µin
Contact Underplating Material	Nickel
PCB Contact Termination Area Plating Material	Gold Flash
Contact Type	Pin
Contact Mating Area Plating Material	Gold
Contact Base Material	Phosphor Bronze
Contact Current Rating (Max)	2 A

Termination Features

Termination Method to Wire & Cable	Insulation Displacement (IDC)
Product Terminates To	Wire & Cable

Dimensions

Accepts Conductor Width	1.27 mm, 2.33 mm
-------------------------	------------------

Compatible Insulation Diameter Range	1.02 – 1.42 mm [.04 – .056 in]
--------------------------------------	--------------------------------

Wire Size	.12 – .4 mm ²
-----------	--------------------------

Usage Conditions

Operating Temperature Range	-65 – 105 °C [-85 – 221 °F]
-----------------------------	-----------------------------

Operation/Application

Circuit Application	Signal
---------------------	--------

Packaging Features

Packaging Method	Reel
------------------	------

Product Compliance

[For compliance documentation, visit the product page on TE.com>](#)

EU RoHS Directive 2011/65/EU	Compliant
------------------------------	-----------

EU ELV Directive 2000/53/EC	Compliant
-----------------------------	-----------

China RoHS 2 Directive MIIT Order No 32, 2016	No Restricted Materials Above Threshold
---	---

EU REACH Regulation (EC) No. 1907/2006	Current ECHA Candidate List: JUNE 2024 (241) Candidate List Declared Against: JUNE 2024 (241) Does not contain REACH SVHC
--	---

Halogen Content	Low Halogen - Br, Cl, F, I < 900 ppm per homogenous material. Also BFR/CFR/PVC Free
-----------------	---

Solder Process Capability	Reflow solder capable to 260°C
---------------------------	--------------------------------

Product Compliance Disclaimer

This information is provided based on reasonable inquiry of our suppliers and represents our current actual knowledge based on the information they provided. This information is subject to change. The part numbers that TE has identified as EU RoHS compliant have a maximum concentration of 0.1% by weight in homogenous materials for lead, hexavalent chromium, mercury, PBB, PBDE, DBP, BBP, DEHP, DIBP, and 0.01% for cadmium, or qualify for an exemption to these limits as defined in the Annexes of Directive 2011/65/EU (RoHS2). Finished electrical and electronic equipment products will be CE marked as required by Directive 2011/65/EU. Components may not be CE marked. Additionally, the part numbers that TE has identified as EU ELV compliant have a maximum concentration of 0.1% by weight in homogenous materials for lead, hexavalent chromium, and mercury, and 0.01% for cadmium, or qualify for an exemption to these limits as defined in the Annexes of Directive 2000/53/EC (ELV). Regarding the REACH Regulation, the information TE provides on SVHC in articles for this part number is based on the latest European Chemicals Agency (ECHA) 'Guidance on requirements for substances in articles' posted at this URL: <https://echa.europa.eu/guidance-documents/guidance-on-reach>

Compatible Parts



TE Part # 2-487406-6
RCPT CONTACT,STD PRESS,FFC



TE Part # CAT-F439-R2435254
2.54mm FFC Connectors Receptacle Housing



TE Part # 280637
4POS DBL PIN HSG



TE Part # 485893-4
006 HOUSING FFC PIN 100CL SR



TE Part # 280629
AMPMODU II COSI PIN HSG, SGL ROW, 4 POS.



TE Part # 280628
AMPMODU II COSI PIN HSG, SGL ROW, 2 POS.



TE Part # 485893-5
007 HOUSING FFC PIN 100CL SR



TE Part # 485893-8
010 HOUSING FFC PIN 100CL SR



TE Part # 485893-9
011 HOUSING FFC PIN 100CL SR



TE Part # 1-485893-4
016 HOUSING FFC PIN 100CL SR

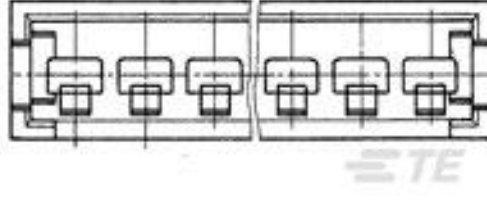

TE Part # 280633
AMPMODU II COSI PIN HSG, SGL ROW, 10 POS



TE Part # 3-88189-2
006 HOUSING FFC PIN DR 100CL



TE Part # 1-485893-0
012 HOUSING FFC PIN 100CL SR



TE Part # 1-88189-0
026 HOUSING FFC PIN DR 100CL

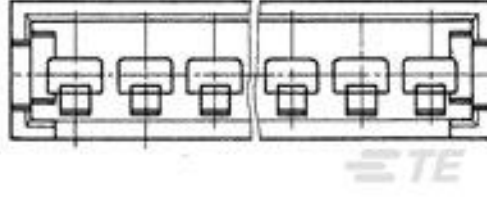

TE Part # 280630
AMPMODU II COSI PIN HSG, SGL ROW, 6 POS.

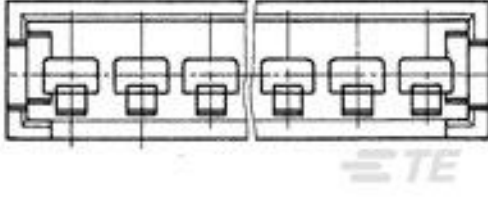

TE Part # 280631
AMPMODU II COSI PIN HSG, SGL ROW, 8 POS.



TE Part # 280638
MOD II HSG



TE Part # 485897-2
004 HOUSING FFC PIN 100CL SR



TE Part # 1-485893-6
018 HOUSING FFC PIN 100CL SR



TE Part # 1-485893-8
020 HOUSING FFC PIN 100CL SR

Customers Also Bought

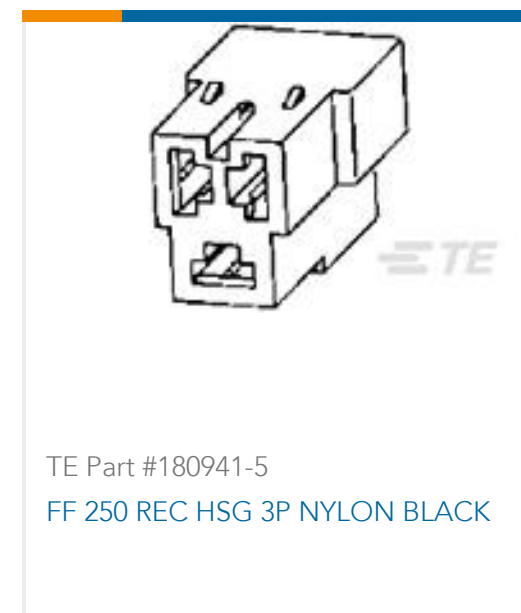
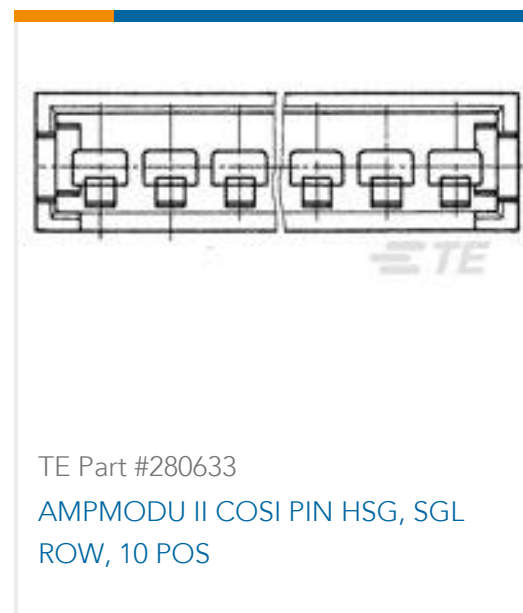
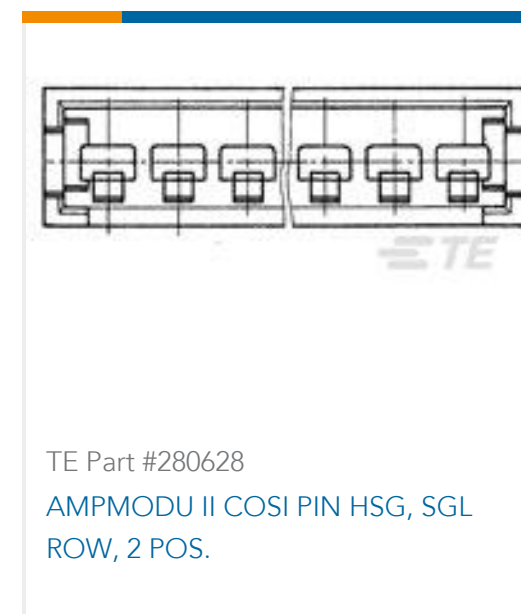
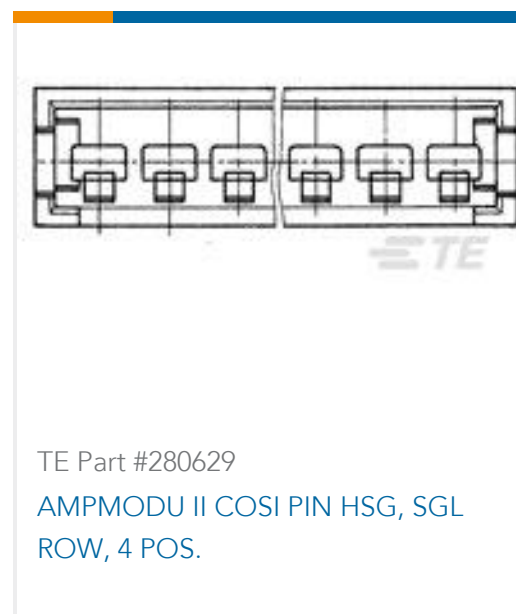

Documents

Product Drawings

[FFC PIN ROUND WIRE PLATED](#)

English

[FFC PIN ROUND WIRE PLATED](#)

English

CAD Files

Customer View Model

[ENG_CVM_CVM_86557-6_AW.2d_dxf.zip](#)

English

[3D PDF](#)

3D

Customer View Model

[ENG_CVM_CVM_86557-6_AW.3d_igs.zip](#)

English

Customer View Model

[ENG_CVM_CVM_86557-6_AW.3d_stp.zip](#)

English

By downloading the CAD file I accept and agree to the [Terms and Conditions](#) of use.



Product Specifications

Application Specification

English

Application Specification

English

Instruction Sheets

Instruction Sheet (U.S.)

English

Instruction Sheet (U.S.)

English

Extraction Tool for Flexible Flat Cable (FFC)

English