

Xinger III

Directional Coupler 20 dB



Description:

The X3C70F1-20S is a low profile, high performance 20dB directional coupler, with a power rating of 25 Watts (AVG) and a peak to average ratio of 12dB, in a new easy to use, Xinger style manufacturing friendly surface mount package. It is designed for 5G (n104), 6G and C-Band applications in all end markets including telecom and COTS Mil-Aero. The X3C70F1-20S is designed particularly for high frequency radio link and other applications where low insertion loss and tight amplitude and phase balance is required.

Parts have been subjected to rigorous Xinger qualification testing and they are manufactured using materials with coefficients of thermal expansion (CTE) compatible with common substrates such as FR4, G-10, RF-35, RO4003 and polyimide. Produced with 6 of 6 RoHS compliant tin immersion finish.

Features:

- 5500-8500 MHz
- 5G (n104), 6G and C-Band COTS Mil-Aero
- Power 25 Watts (AVG)
- Peak to Average Ratio 12dB
- Tight Mean Coupling ($\pm 1.5\text{dB}$)
- High Directivity ($>18\text{dB}$)
- Low loss ($<0.25\text{dB}$)
- Production Friendly
- Tape and Reel
- Lead-Free

Electrical Specifications:

Frequency	Mean Coupling	Directivity	Insertion Loss	VSWR
MHz	dB Min	dB Min	dB Max	Max : 1
5500-8500	20.0 ± 1.5	18	0.25	1.22
Group Delay (GD-C)	Group Delay (GD-DC)	Power	Operating Temp.	
ns	ns	Avg. Watts at 105°C	°C	
0.062 ± 0.02	0.059 ± 0.02	25	-55 to +150	

*Specification based on performance of unit properly installed on TTM Technologies Test Board with small signal applied. Specifications subject to change without notice. Refer to parameter definitions for details.

Outline Drawing:

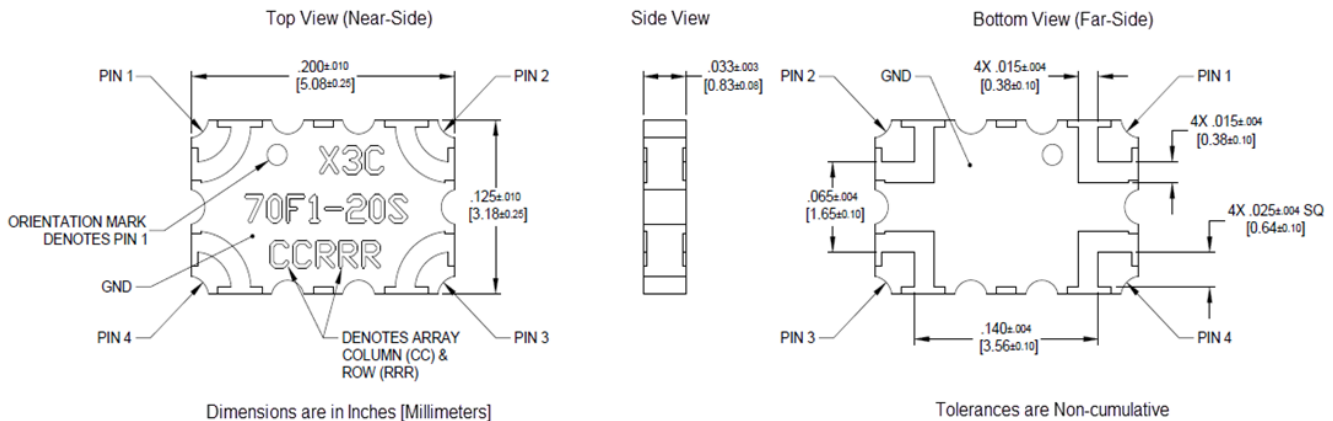

Directional Coupler Pin Configuration:

The X3C70F1-20S has an orientation marker to denote Pin 1. Once port one has been identified the other ports are known automatically. Please see the chart below for clarification:

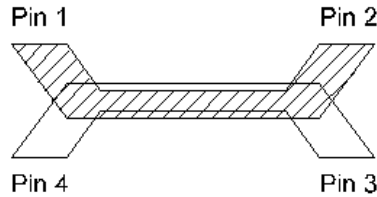

Pin 1	Pin 2	Pin 3	Pin 4
Input	Direct	Isolated	Coupled
Direct	Input	Coupled	Isolated

Note: The direct port has a DC connection to the input port and the coupled port has a DC connection to the isolated port. For optimum IL and power handling performance, use Pin 1 or Pin 2 as inputs.

Peak Power Handling

High-Pot testing of these couplers during the qualification procedure resulted in a minimum breakdown voltage of 1.49Kv (minimum recorded value). This voltage level corresponds to a breakdown resistance capable of handling at least 12dB peak over average power levels, for very short durations. The breakdown location consistently occurred across the air interface at the coupler contact pads (see illustration below). The breakdown levels at these points will be affected by any contamination in the gap area around these pads. These areas must be kept clean for optimum performance. It is recommended that the user test for voltage breakdown under the maximum operating conditions and over worst case modulation induced power peaking. This evaluation should also include extreme environmental conditions (such as high humidity).

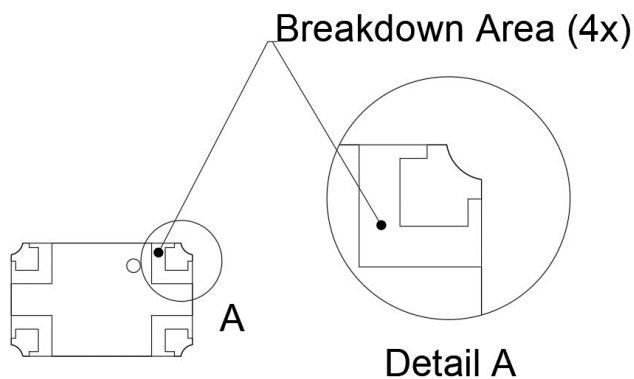

Insertion Loss and Power Derating Curves:

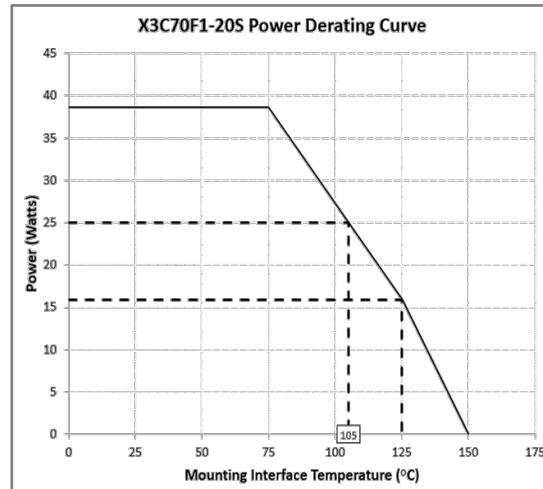
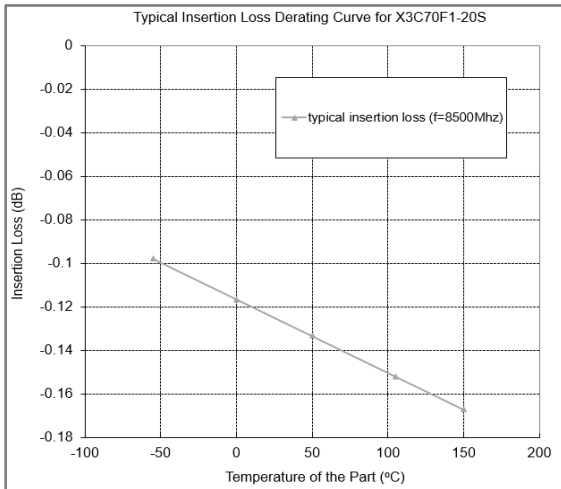

Insertion Loss Derating:

The insertion loss, at a given frequency, of the coupler is measured at 25°C and then averaged. The measurements are performed under small signal conditions (i.e. using a Vector Network Analyzer). The process is repeated at 105°C and 150°C. A best-fit line for the measured data is computed and then plotted from -55°C to 150°C.

Power Derating:

The power handling and corresponding power derating plots are a function of the thermal resistance, mounting surface temperature (base plate temperature), maximum continuous operating temperature of the coupler, and the thermal insertion loss. The thermal insertion loss is defined in the Power Handling section of the data sheet.

As the mounting interface temperature approaches the maximum continuous operating temperature, the power handling decreases to zero.

If mounting temperature is greater than 105°C, the Xinger coupler will perform reliably as long as the input power is derated to the curve above.

Typical Performance: 5500 to 8500 MHz

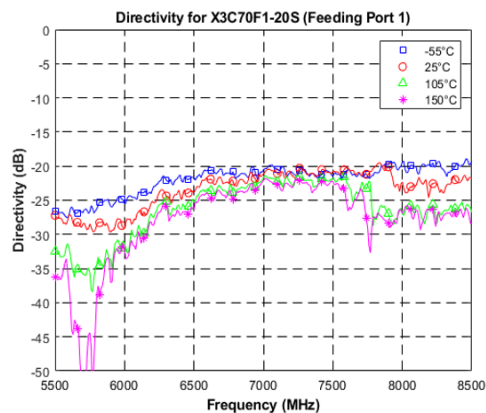
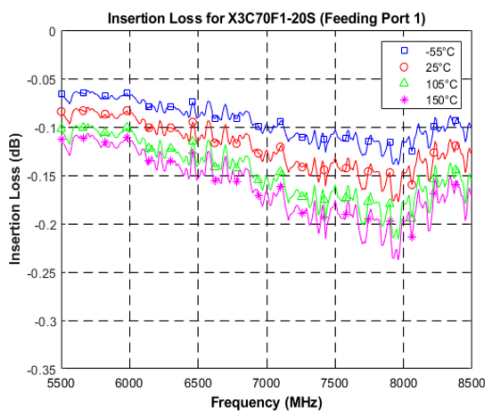
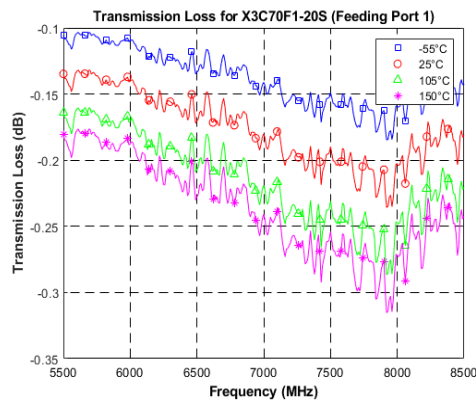
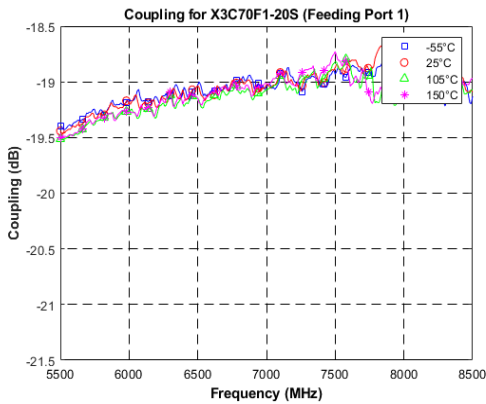
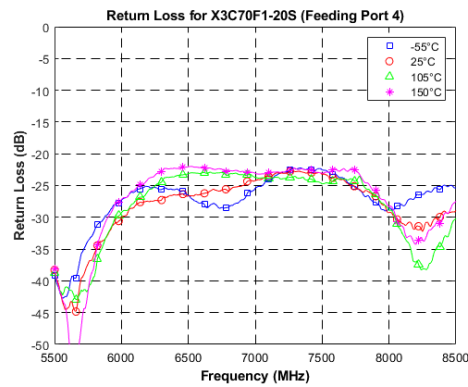
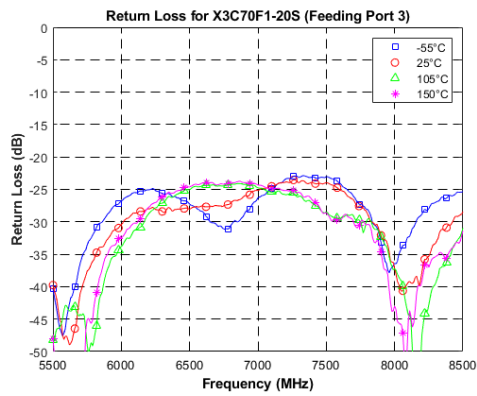
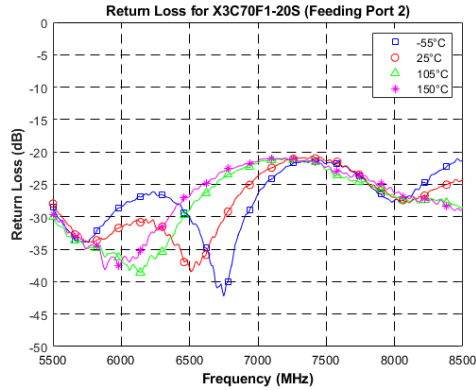
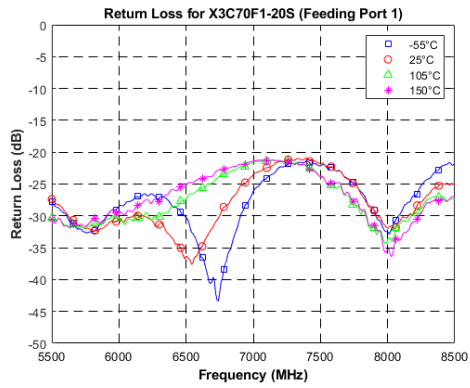

Definition of Measured Specifications:

Parameter	Definition	Mathematical Representation
VSWR (Voltage Standing Wave Ratio)	The impedance match of the coupler to a 50Ω system. A VSWR of 1:1 is optimal.	$VSWR = \frac{V_{max}}{V_{min}}$ Vmax = voltage maxima of a standing wave Vmin = voltage minima of a standing wave
Return Loss	The impedance match of the coupler to a 50Ω system. Return Loss is an alternate means to express VSWR.	$Return\ Loss(dB) = 20\log \frac{VSWR + 1}{VSWR - 1}$
Mean Coupling	At a given frequency (ω_n), coupling is the input power divided by the power at the coupled port. Mean coupling is the average value of the coupling values in the band. N is the number of frequencies in the band.	$Coupling(dB) = C(\omega_n) = 10\log \frac{P_{in}(\omega_n)}{P_{cpl}(\omega_n)}$ $Mean\ Coupling(dB) = \frac{\sum_{n=1}^N C(\omega_n)}{N}$
Insertion Loss	The input power divided by the sum of the power at the two output ports.	$Insertion\ Loss(dB) = 10\log \frac{P_{in}}{P_{cpl} + P_{direct}}$
Transmission Loss	The input power divided by the power at the direct port.	$10\log \frac{P_{in}}{P_{direct}}$
Directivity	The power at the coupled port divided by the power at the isolated port.	$10\log \frac{P_{cpl}}{P_{iso}}$
Frequency Sensitivity	The decibel difference between the maximum in band coupling value and the mean coupling, and the decibel difference between the minimum in band coupling value and the mean coupling.	Max Coupling (dB) – Mean Coupling (dB) and Min Coupling (dB) – Mean Coupling (dB)
Group Delay	Group delay is average of group delay's from input port to the coupled port	Average (GD-C)
Group Delay (GD-DC)	Group delay is average of group delay's from input port to the direct port	Average (GD-DC)

Packaging and Ordering Information:

Parts are available in reels. Packaging follows EIA 481 for reels. Parts are oriented in tape and reel as shown below. Tape and reel is available in 4000 pcs per reel.

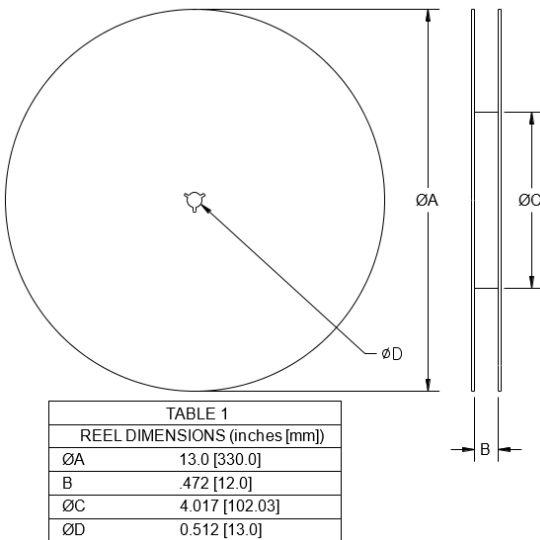
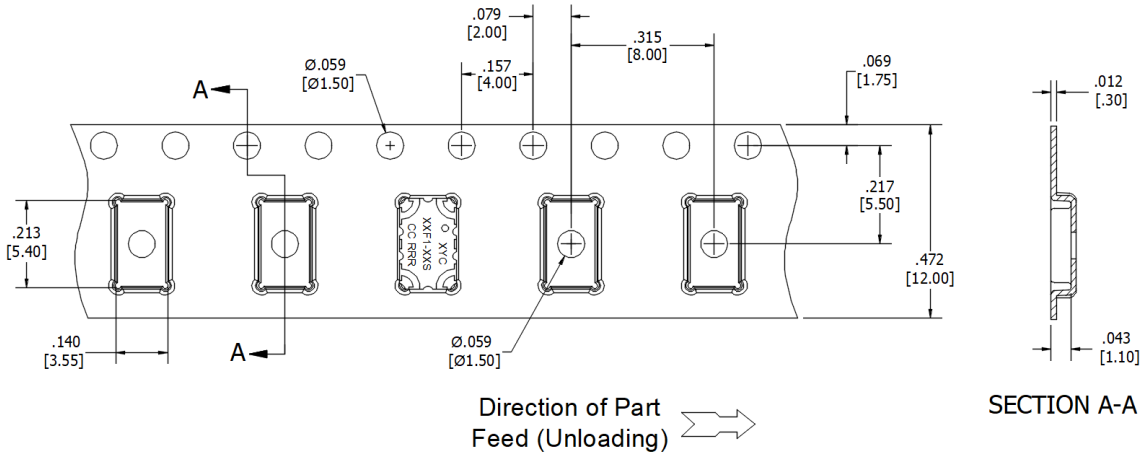

Contact us:
rf&s_support@ttm.com