

PCB LAYOUT - COMPONENT VIEW  
TOLERANCES: ±0.05

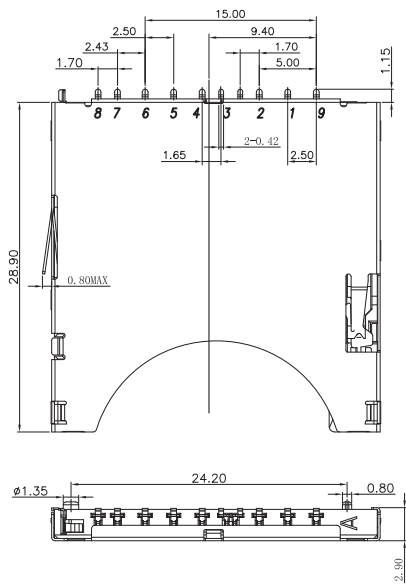
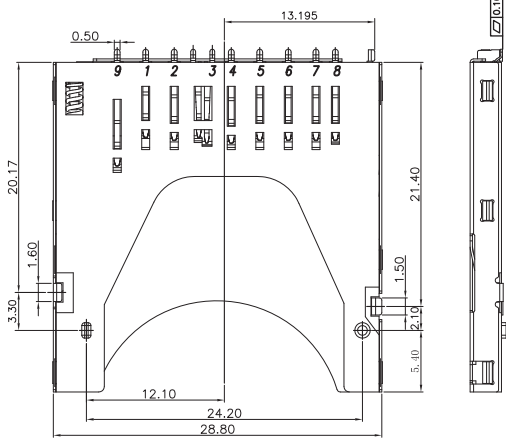

TECHNICAL CHARACTERISTICS

MATERIAL  
INSULATOR: LCP  
FLAMMABILITY RATING: UL94-V0  
COLOR: BLACK  
CONTACT MATERIAL: COPPER ALLOY  
CONTACT TYPE: STAMPED  
CONTACT PLATING: SELECTIVE GOLD  
SHIELDING: STAINLESS STEEL  
QUALITY CLASS: 10000 MATING CYCLES

ENVIRONMENTAL  
OPERATING TEMPERATURE: -25 UP TO 85°C  
COMPLIANCE: LEAD FREE AND ROHS

ELECTRICAL  
CURRENT RATING: 0.5A  
WORKING VOLTAGE: 100VAC  
INSULATOR RESISTANCE: >1000 MOHM

CONTACT RESISTANCE: 100 mOHM MAX

SOLDERING  
REFLOW PROCESS ONLY

PACKAGING  
TAPE & REEL

PIN No	Name	DESCRIPTION
1	CD/DAT3	Connector data line 3
2	CMD	COMMAND/ANSWER
3	Vss1	GND
4	Vdd	POWER SUPPLY
5	CLK	GLOCK
6	Vss2	GND
7	DAT0	Connector data line 0
8	DAT1	Connector data line 1
9	DAT2	Connector data line 2

RoHS Compliant			
L	13-NOV-15	PINNING	AK
K	03-AUG-15	PROHIBITED AREA	AK
J	30-JUN-15	DRAWING	AK
I	02-FEB-15	LAYOUT	QL
H	06-JAN-15	DIMENSIONS	QP
REV	DATE	FILE	BY

PROJECTION:

APPROVAL: NPr

GENERAL TOLERANCE  
.X = +/- 0.2  
.XX = +/- 0.15

UNIT: MM  
SCALE:  
SHEET: 1/4  
DRAW: AK



DESCRIPTION: SD Card Connector - Push & Push - With Card Detection  
9 pins  
WERI PART NO: 693 061 010 911

SIZE  
**A4**

1

2

3

4

5

A

Contact OFF

Contact ON / Lock OFF

Contact ON / LOCK ON



DETAIL U

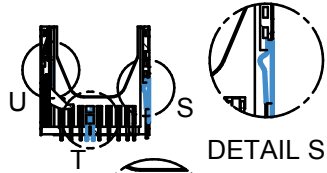

DETAIL T

DETAIL S

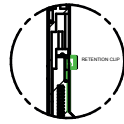

DETAIL W

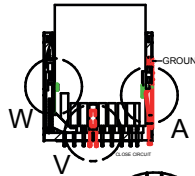

DETAIL V

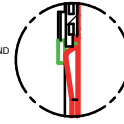

DETAIL A



DETAIL Y

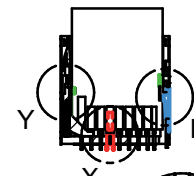

DETAIL X

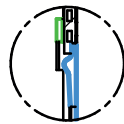

DETAIL B

B

C

Card detection switch		Write protection switch		
Card removed	Card inserted	Card removed	Card inserted	
			Write Protect	Write enable
OPEN	CLOSE	OPEN	OPEN	CLOSE

RoHS Compliant

PROJECTION:



GENERAL TOLERANCE

.X = +/- 0.2

.XX = +/- 0.15



APPROVAL: NPR

UNIT: MM

SCALE:

SHEET: 2/4

DRAW: VICKY

DESCRIPTION: SD Card Connector - Push & Push - With Card Detection  
9 pins

WERI PART NO: 693 061 010 911

SIZE

A4

D

REV	DATE	FILE	BY
-----	------	------	----

1

2

3

4

5

PACKING DIRECTION  
←→  
DIRECTION OF UNREELING

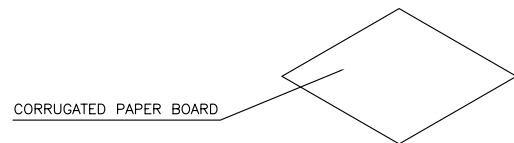

CORRUGATED PAPER BOARD

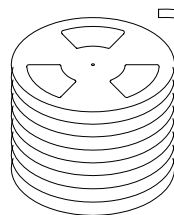

FITTING TAPE

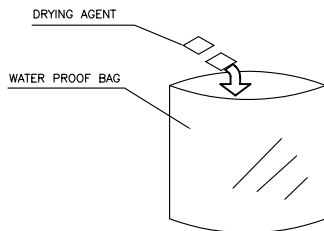

DRYING AGENT

WATER PROOF BAG

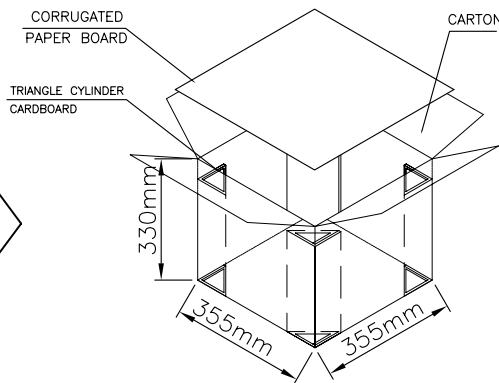

CORRUGATED PAPER BOARD

TRIANGLE CYLINDER CARDBOARD

CARTON

330mm  
355mm  
355mm

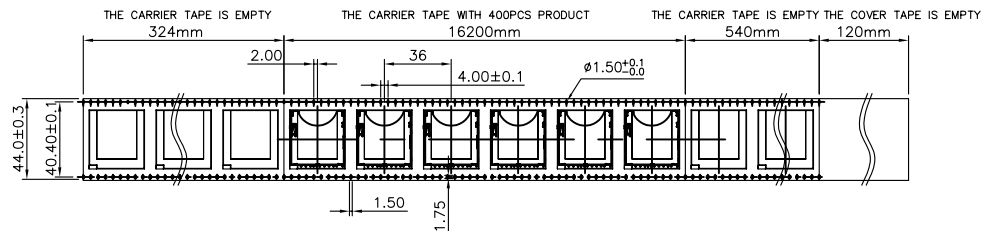

THE CARRIER TAPE IS EMPTY  
324mm

THE CARRIER TAPE WITH 400PCS PRODUCT  
16200mm

THE CARRIER TAPE IS EMPTY THE COVER TAPE IS EMPTY  
540mm 120mm

2.00 36 4.00±0.1 ø1.50±0.1  
44.0±0.3 40.40±0.1  
1.50 1.75

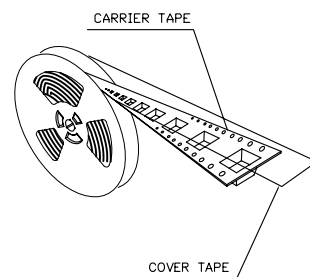

CARRIER TAPE

COVER TAPE

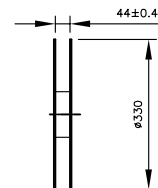
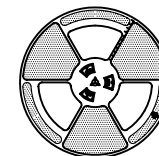

400 pcs/reel  
6 reels/carton  
2400 pcs/carton

RoHS Compliant

PROJECTION:

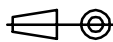

GENERAL TOLERANCE

.X = +/- 0.2  
.XX = +/- 0.15



APPROVAL: NPr

UNIT: MM

SCALE:

SHEET: 3/4

DRAW: VICKY

DESCRIPTION: SD Card Connector - Push & Push - With Card Detection  
9 pins

WERI PART NO: 693 061 010 911

SIZE

A4

REV DATE FILE BY

1

2

3

4

5

## Cautions and Warnings:

This electronic component is designed and developed with the intention for use in general electronics equipments.

Before incorporating the components into any equipments in the field such as aerospace, aviation, nuclear control, submarine, transportation, (automotive control, train control, ship control), transportation signal, disaster prevention, medical, public information network etc. where higher safety and reliability are especially required or if there is possibility of direct damage or injury to human body, Würth Elektronik must be asked for a written approval.



In addition, even electronic component in general electronic equipments, when used in electrical circuits that require high safety, reliability functions or performance, the sufficient reliability evaluation-check for the safety must be performed before by the user before usage.

A

B

C

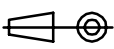
RoHS Compliant

G				PROJECTION: 	GENERAL TOLERANCE .X = +/- 0.2 .XX = +/- 0.15		
F							
E							
D							
C				APPROVAL: JC	UNIT: MM	DESCRIPTION: DISCLAIMER	SIZE <b>A4</b>
B					SCALE:		
A	10-SEP-14	PDF	QL		SHEET: 4/4	WERI PART NO: DISCLAIMER	
REV	DATE	FILE	BY		DRAW: QL		

D