

REVISIONS					
REV.	ECN NO.	LOCATION	DESCRIPTION	DATE	DESIGN
A0	N/A		INITIAL RELEASE	/	/
A1	N/A		图面升级整理图面	2024.11.12	阿树

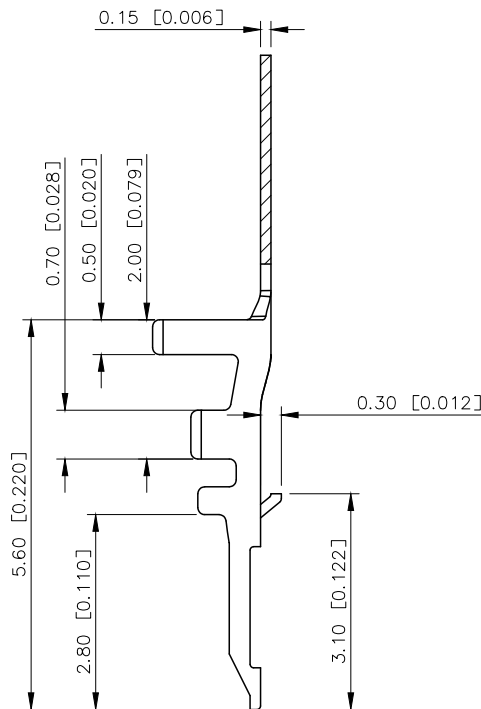
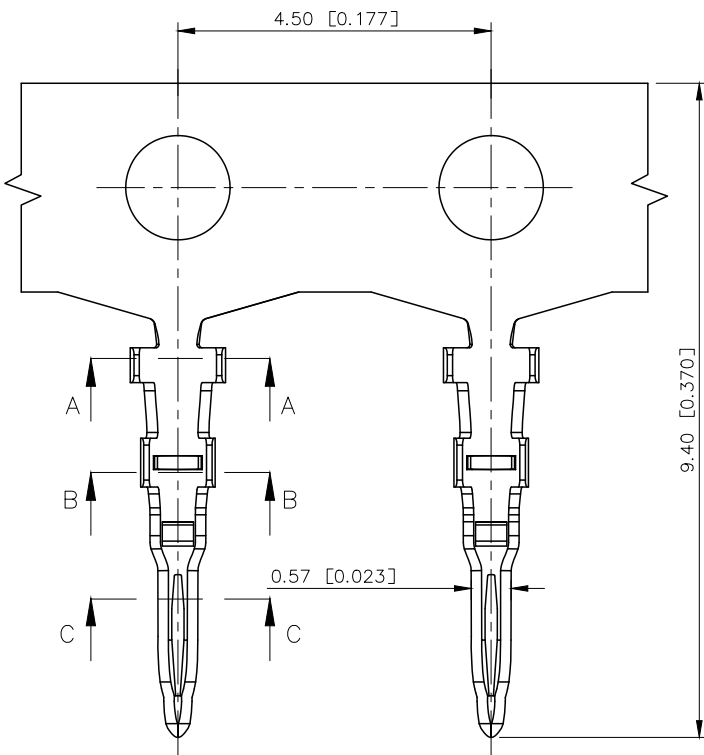

■ SPECIFICATIONS

- Voltage rating: 500V AC/DC
- Current rating: 1A AC/DC
- Withstanding Voltage: 250V AC/minute
- Temperature range: -40°C~+125°C
- Insulation resistance:  $\geq 100M\Omega$
- Contact resistance:  $\leq 10m\Omega$
- After environment testing:  $\leq 20m\Omega$

PART NO.:

X1259 T-P SN  
① ② ③ ④

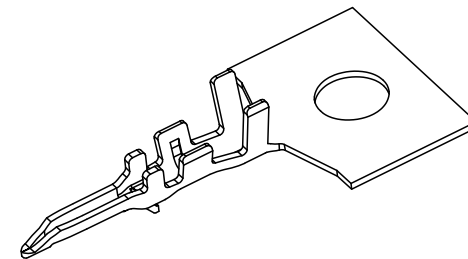

- ① Series Number.
- ② Category: T-terminal
- ③ Material: P-Phosphor bronze
- ④ Plating Category: SN-Bright Tin Plating

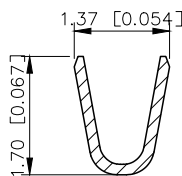

SECTION: A-A  
SCALE: 1: 1

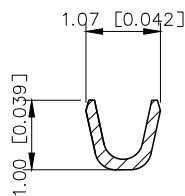

SECTION: B-B  
SCALE: 1: 1

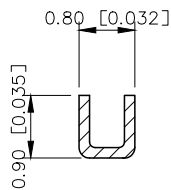

SECTION: C-C  
SCALE: 1: 1

X1259T-PSN	Phosphor Bronze	AWG#28-32	1.00mm (Max)	Plating Before Plating: 30u"MIN.Ni; 70u"Sn	X1259H
PART NO	Material	Wire Range	Insulation O.D	Finish	Use d in XKB Housing

AuGLAR	$\pm 5^\circ$
X.	$\pm 0.40$
X.x	$\pm 0.30$
X.xx	$\pm 0.20$
X.xxx	$\pm 0.15$
UNSPECIFIED TOLERANCES	



DESIGN  
CHECKED  
APPROVED

阿树

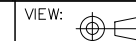

UNIT: mm/in

SIZE: A4

MODEL TYPE:  
1.25mm Crimp Style Connectors

PART NO.:  
X1259T-PSN

DWG NO.:

SCALE	PAGE	REVISION
N/A	1/1	A1