



MTA 156

TE Internal #: 3-647479-9

Connector Assembly, Receptacle, Mating Alignment, Polarization
 Mating Alignment Type, Mating Retention, MTA 156, Standard
 Rectangular Connectors

[View on TE.com >](#)

Connectors > Rectangular Connectors > Standard Rectangular Connectors

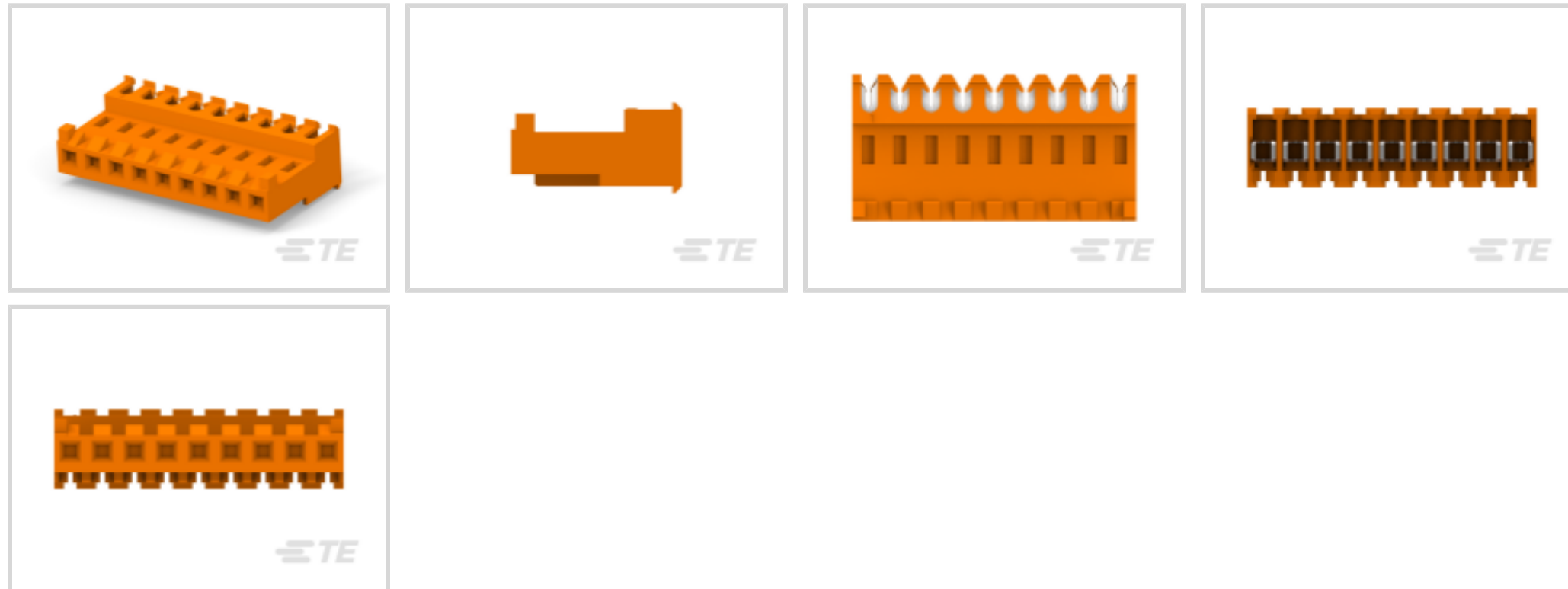

Connector Product Type: **Connector Assembly**

Connector & Housing Type: **Receptacle**

Mating Alignment: **With**

Mating Alignment Type: **Polarization**

Mating Retention: **With**

Features

Product Type Features

Compatible With Discrete Wire Type	Stranded
Connector Product Type	Connector Assembly
Connector & Housing Type	Receptacle
Connector System	Wire-to-Board
Insertion Force Type	Normal
Sealable	No
Connector & Contact Terminates To	Wire & Cable

Configuration Features

Number of Cavities	9
Contacts Preloaded	Yes
Number of Positions	9
Number of Rows	1

Electrical Characteristics

Operating Voltage	600 VAC
-------------------	---------



Contact Features

Contact Type	Receptacle
Wire Contact Termination Area Plating Material	Tin
Contact Underplating Material	Nickel
Contact Mating Area Plating Material	Gold, Gold Flash over Palladium Nickel
Contact Retention Within Housing	With
Contact Current Rating (Max)	7 A

Termination Features

Termination Method to Wire & Cable	Insulation Displacement (IDC)
------------------------------------	-------------------------------

Mechanical Attachment

Contact Retention Type Within Housing	Locking Lance
Mating Alignment	With
Mating Alignment Type	Polarization
Mating Retention	With
Mating Retention Type	Locking Ramp
Connector Mounting Type	Cable Mount (Free-Hanging)

Housing Features

Housing Material	Nylon 6/6
Housing Color	Orange
Centerline (Pitch)	3.96 mm[.156 in]

Dimensions

Connector Height	18.42 mm[.725 in]
Product Width	9.78 mm[.385 in]
Product Length	35.66 mm[1.404 in]
Wire Size	.8 – .9 mm ²

Usage Conditions

Operating Temperature Range	-55 – 105 °C[-67 – 221 °F]
-----------------------------	----------------------------

Operation/Application

Shielded	No
Circuit Application	Power

Industry Standards

CSA Rating	LR 7189
------------	---------



UL Rating	Recognized
Compatible With Agency/Standards Products	CSA, UL
Compatible With Approved Standards Products	UL E28476
UL Flammability Rating	UL 94V-2

Packaging Features

Packaging Quantity	250
Packaging Method	Bag/Box

Product Compliance

[For compliance documentation, visit the product page on TE.com>](#)

EU RoHS Directive 2011/65/EU	Compliant
EU ELV Directive 2000/53/EC	Compliant
China RoHS 2 Directive MIIT Order No 32, 2016	No Restricted Materials Above Threshold
EU REACH Regulation (EC) No. 1907/2006	Current ECHA Candidate List: JUNE 2024 (241) Candidate List Declared Against: JUNE 2024 (241) Does not contain REACH SVHC
Halogen Content	Low Halogen - Br, Cl, F, I < 900 ppm per homogenous material. Also BFR/CFR/PVC Free
Solder Process Capability	Not applicable for solder process capability

Product Compliance Disclaimer

This information is provided based on reasonable inquiry of our suppliers and represents our current actual knowledge based on the information they provided. This information is subject to change. The part numbers that TE has identified as EU RoHS compliant have a maximum concentration of 0.1% by weight in homogenous materials for lead, hexavalent chromium, mercury, PBB, PBDE, DBP, BBP, DEHP, DIBP, and 0.01% for cadmium, or qualify for an exemption to these limits as defined in the Annexes of Directive 2011/65/EU (RoHS2). Finished electrical and electronic equipment products will be CE marked as required by Directive 2011/65/EU. Components may not be CE marked. Additionally, the part numbers that TE has identified as EU ELV compliant have a maximum concentration of 0.1% by weight in homogenous materials for lead, hexavalent chromium, and mercury, and 0.01% for cadmium, or qualify for an exemption to these limits as defined in the Annexes of Directive 2000/53/EC (ELV). Regarding the REACH Regulation, the information TE provides on SVHC in articles for this part number is based on the latest European Chemicals Agency (ECHA) 'Guidance on requirements for substances in articles' posted at this URL: <https://echa.europa.eu/guidance-documents/guidance-on-reach>

Compatible Parts



Also in the Series | **MTA 156**

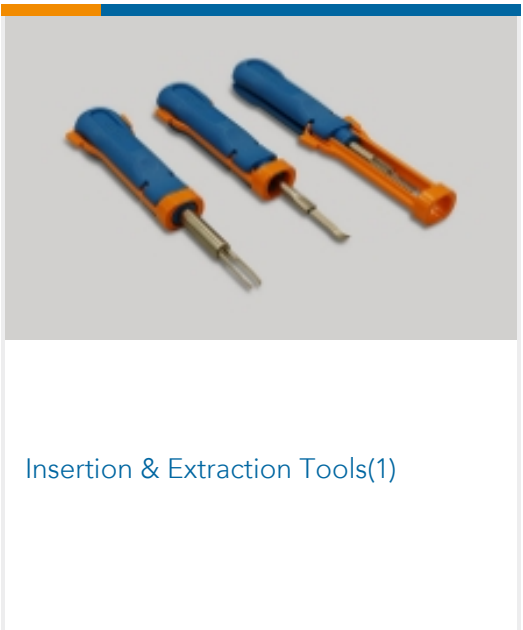
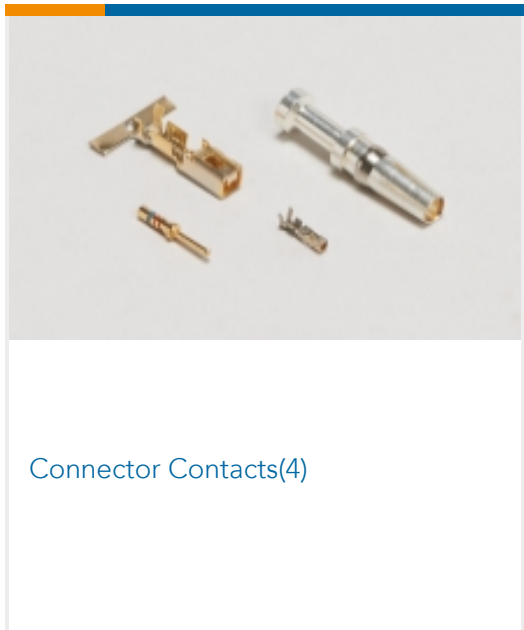



PCB Headers & Receptacles(317)



Rectangular Power Connectors(691)



Standard Rectangular Connectors(336)

Customers Also Bought



TE Part #3-1630027-9
HSC300 R22 5%

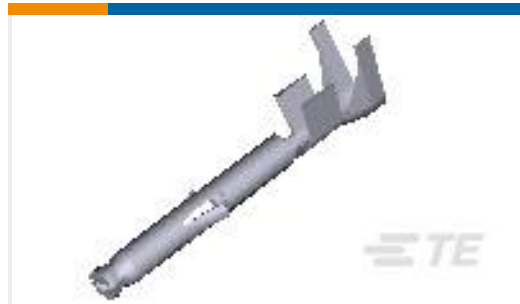

TE Part #770988-1
MINI UMNL SOK 22-18AWG SN LP



TE Part #172234-1
3P MINI UNIVERSAL MATE-N-LOK
CAP HOUSING

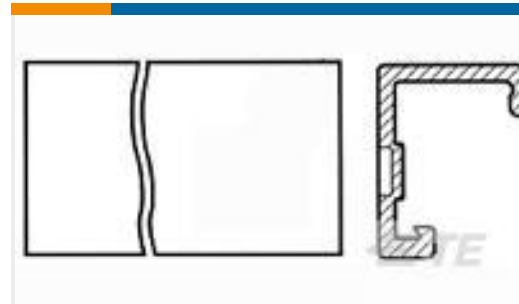

TE Part #640551-9
09P MTA156 COVER



TE Part #770987-1
MINI UMNL PIN 22-18AWG SN LP



TE Part #2329384-1
PB OFF/ON FC BLK M1 TERM IP68
500MM L

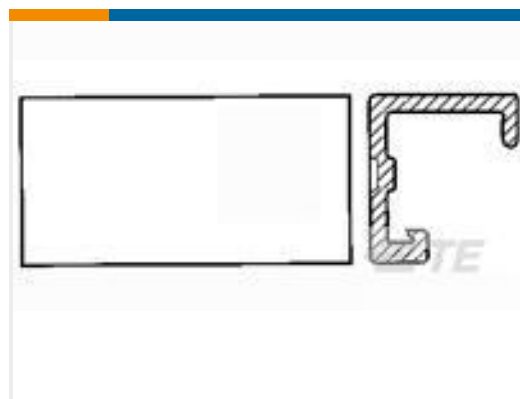

TE Part #640550-9
09P MTA100 COVER

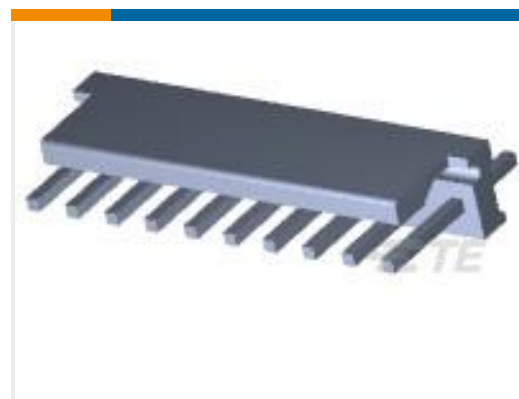

TE Part #1-644752-0
10P MTA156 HDR ASSY SQ STR F/L

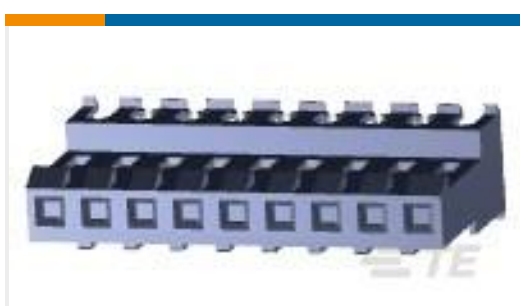

TE Part #3-640601-9
09P MTA156 CONN ASSY 22AWG LF



TE Part #3-641227-4
04P MTA156 CONN ASSY 18AWG LF

Documents

Product Drawings

[09P MTA156 CONN ASSY 18AWG ORA](#)

English

CAD Files

[3D PDF](#)

[3D](#)

Customer View Model

[ENG_CVM_CVM_3-647479-9_G.2d_dxf.zip](#)



English

Customer View Model

[ENG_CVM_CVM_3-647479-9_G.3d_igs.zip](#)

English

Customer View Model

[ENG_CVM_CVM_3-647479-9_G.3d_stp.zip](#)

English

By downloading the CAD file I accept and agree to the [Terms and Conditions](#) of use.

Product Specifications

Application Specification

Japanese

Application Specification

English

MTA 156 Ribbon Cable Connector Assemblies (English And Spanish)

English

MTA 156 Ribbon Cable Connector Assemblies (English And Spanish)

Japanese

Application Specification

English

Agency Approvals

Agency Approval Document

English