

## 2.4 GHz IEEE Std. 802.15.4™ RF Transceiver Module with PA/LNA

### Features:

- IEEE Std. 802.15.4™ Compliant RF Transceiver
- Supports ZigBee®, MiWi™ Development Environment Proprietary Wireless Networking Protocols
- 4-Wire Serial Peripheral Interface (SPI) with Interrupt
- Small size: 0.9" x 1.3" (22.9 mm x 33.0 mm), Surface Mountable: Pin Compatible with MRF24J40MB and MRF24J40MC
- Integrated Crystal, Internal Voltage Regulator, Matching Circuitry, Power Amplifier, Low Noise Amplifier
- PCB Antenna (MRF24J40MD), External Antenna Connector (MRF24J40ME): Ultra Miniature Coaxial (U.FL), 50Ω
- Easy Integration into Final Product: Minimize Product Development, Quicker Time to Market
- Compliance:
  - Modular Certified for the United States (FCC) and Canada (IC)
  - European R&TTE Directive Assessed Radio Module
  - Australia/New Zealand
- Compatible with Microchip microcontroller families (PIC16, PIC18, PIC24, dsPIC33 and PIC32)
- Range up to 4000 ft

### Operational:

- Operating Voltage: 3.0V-3.6V (3.3V typical)
- Temperature Range: -40°C to +85°C Industrial
- Low-Current Consumption:
  - Rx Mode: 32 mA (typical)
  - Tx Mode: 140 mA (typical)
  - Sleep: 10 μA (typical)

### RF/Analog Features:

- ISM Band 2.405 GHz-2.475 GHz Operation
- Data Rate: 250 kbps
- -104 dBm Typical Sensitivity with -23 dBm Maximum Input Level
- +19 dBm Typical Output Power with 45 dB Tx Power Control Range
- Integrated Low Phase Noise VCO, Frequency Synthesizer and PLL Loop Filter
- Digital VCO and Filter Calibration
- Integrated RSSI ADC and I/Q DACs
- Integrated LDO
- High Receiver RSSI Dynamic Range

### MAC/Baseband Features:

- Hardware CSMA-CA Mechanism, Automatic ACK Response and FCS Check
- Independent Beacon, Transmit and GTS FIFO
- Supports all CCA modes and RSS/LQI
- Automatic Packet Retransmit Capable
- Hardware Security Engine (AES-128) with CTR, CCM and CBC-MAC modes
- Supports Encryption and Decryption for MAC Sub layer and Upper Layer

### Pin Diagram:

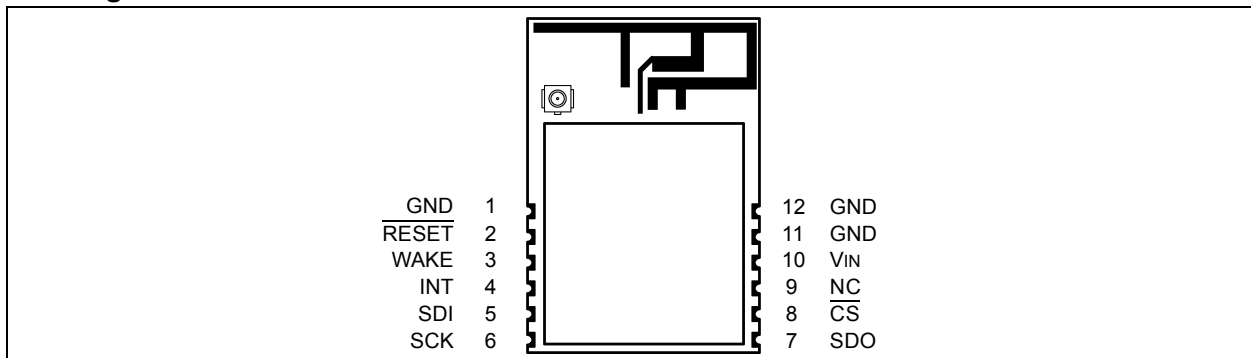

# MRF24J40MD/ME

---

## Table of Contents

1.0 Device Overview .....	3
2.0 Circuit Description .....	11
3.0 Regulatory Approval .....	19
4.0 Electrical Characteristics .....	25
Appendix A: Revision History .....	27
The Microchip Web Site .....	29
Customer Change Notification Service .....	29
Product Identification System .....	30

## TO OUR VALUED CUSTOMERS

It is our intention to provide our valued customers with the best documentation possible to ensure successful use of your Microchip products. To this end, we will continue to improve our publications to better suit your needs. Our publications will be refined and enhanced as new volumes and updates are introduced.

If you have any questions or comments regarding this publication, please contact the Marketing Communications Department via E-mail at [docerrors@microchip.com](mailto:docerrors@microchip.com) or fax the **Reader Response Form** in the back of this data sheet to (480) 792-4150. We welcome your feedback.

### Most Current Data Sheet

To obtain the most up-to-date version of this data sheet, please register at our Worldwide Web site at:

<http://www.microchip.com>

You can determine the version of a data sheet by examining its literature number found on the bottom outside corner of any page. The last character of the literature number is the version number, (e.g., DS30000A is version A of document DS30000).

### Errata

An errata sheet, describing minor operational differences from the data sheet and recommended workarounds, may exist for current devices. As device/documentation issues become known to us, we will publish an errata sheet. The errata will specify the revision of silicon and revision of document to which it applies.

To determine if an errata sheet exists for a particular device, please check with one of the following:

- Microchip's Worldwide Web site; <http://www.microchip.com>
- Your local Microchip sales office (see last page)

When contacting a sales office, please specify which device, revision of silicon and data sheet (include literature number) you are using.

### Customer Notification System

Register on our web site at [www.microchip.com](http://www.microchip.com) to receive the most current information on all of our products.

## 1.0 DEVICE OVERVIEW

The MRF24J40MD/ME is a 2.4 GHz IEEE Std. 802.15.4™ compliant, surface mount module with integrated crystal, internal voltage regulator, matching circuitry, Power Amplifier (PA), Low Noise Amplifier (LNA) with PCB Trace Antenna (MRF24J40MD) or 50Ω external antenna connector (MRF24J40ME). The MRF24J40MD/ME module operates in the non-licensed 2.4 GHz frequency band. The integrated module design frees the integrator from extensive RF and antenna design, and regulatory compliance testing allowing quicker time to market.

The MRF24J40MD/ME module is compatible with Microchip's MiWi™ Development Environment software stacks. The MiWi Development Environment software stack including the source code is available as a free download, from the Microchip web site: <http://www.microchip.com/wireless>.

The MRF24J40MD/ME module has received regulatory approvals for modular devices in the United States (FCC) and Canada (IC). Modular approval removes the need for expensive RF and antenna design, and allows the end user to place the MRF24J40MD/ME module inside a finished product and does not require regulatory testing for an intentional radiator (RF transmitter). To maintain conformance, refer to module settings in [Section 3.1.2 "RF Exposure"](#) for the United States and [Section "Transmitter Antenna \(from Section 7.1.2 RSS-Gen,](#)

[Issue 3, December 2010\): User manuals for transmitters shall display the following notice in a conspicuous location:"](#) for Canada.

The MRF24J40MD/ME module is an R&TTE Directive assessed radio module for operation in Europe. The module tests can be applied toward final product certification and Declaration of Conformity (DoC). To maintain conformance for Europe, refer to module settings in [Section 3.4 "Australia"](#). Additional testing may be required depending on the end application.

## 1.1 Interface Description

[Figure 1-1](#) shows a simplified block diagram of the MRF24J40MD/ME module. The module is based on the Microchip Technology MRF24J40 IEEE 802.15.4™ 2.4 GHz RF Transceiver IC. The module interfaces to many popular Microchip PIC® microcontrollers through a 4-wire SPI interface, interrupt, wake, reset, power and ground, as shown in [Figure 1-2](#). [Table 1-1](#) provides the pin descriptions.

Serial communication and module configuration for the MRF24J40MD/ME module are documented in the "[MRF24J40 Data Sheet](#)" (DS39776). Refer to the data sheet for specific serial interface protocol and register definitions.

Also, see [Section 1.4 "Operation"](#) for specific register settings that are unique to the MRF24J40MD/ME module.

FIGURE 1-1: MRF24J40MD/ME BLOCK DIAGRAM

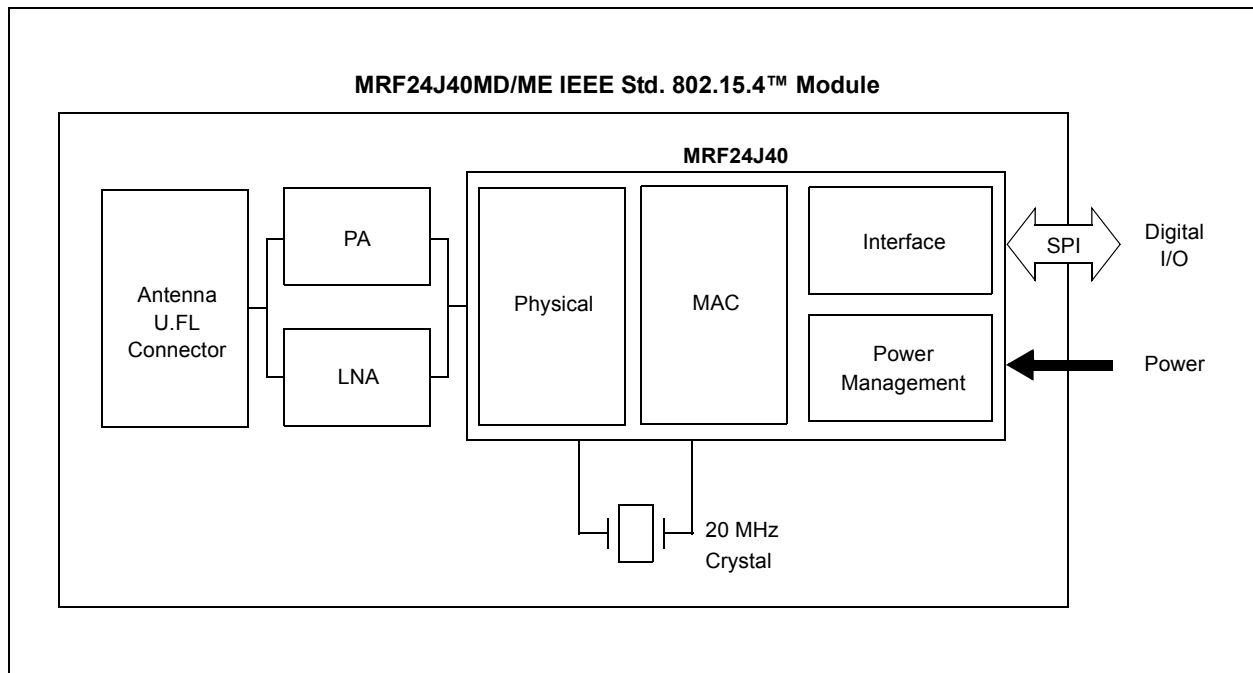

# MRF24J40MD/ME

**TABLE 1-1: PIN DESCRIPTION**

Pin	Symbol	Type	Description
1	GND	Ground	Ground
2	$\overline{\text{RESET}}$	DI	Global hardware Reset pin
3	WAKE	DI	External wake-up trigger
4	INT	DO	Interrupt pin to microcontroller
5	SDI	DI	Serial interface data input
6	SCK	DI	Serial interface clock
7	SDO	DO	Serial interface data output from MRF24J40
8	$\overline{\text{CS}}$	DI	Serial interface enable
9	NC	—	No connection
10	V <sub>IN</sub>	Power	Power supply
11	GND	Ground	Ground
12	GND	Ground	Ground

**Legend:** Pin type abbreviation: D = Digital, I = Input, O = Output

**FIGURE 1-2: MICROCONTROLLER TO MRF24J40MD/ME INTERFACE**

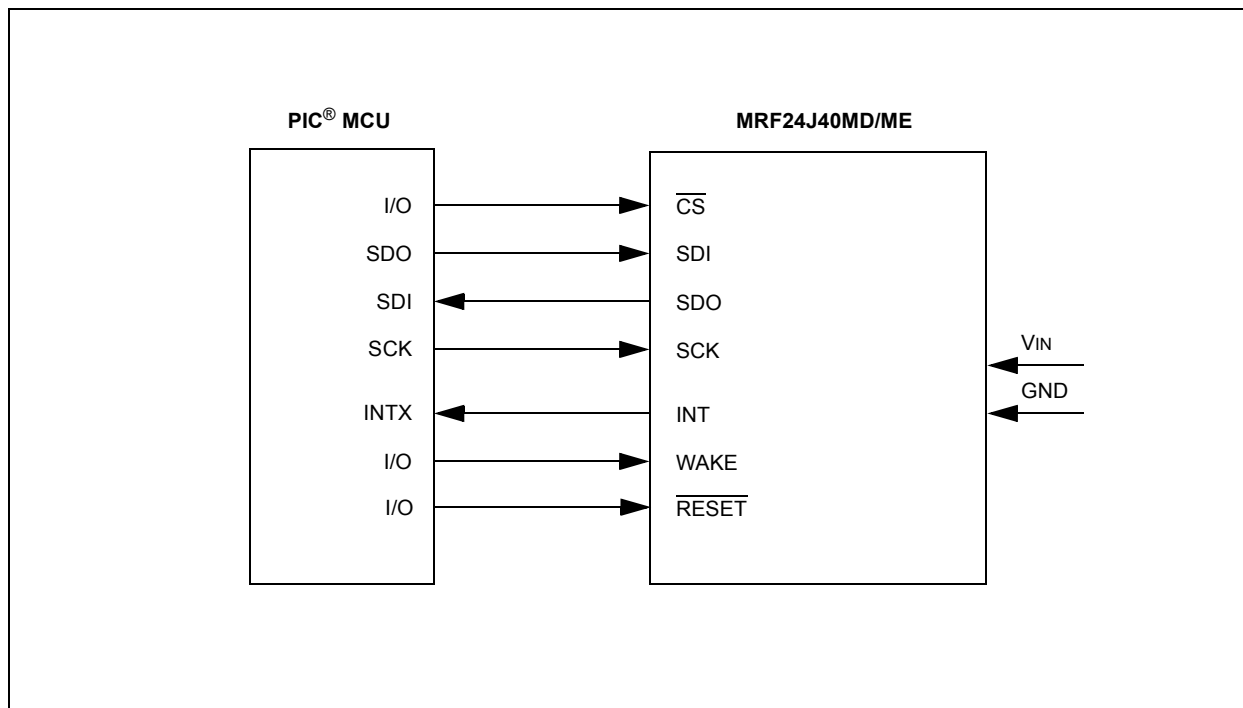

## 1.2 Mounting Details

The MRF24J40MD/ME is a surface mountable module. Module dimensions are shown in Figure 1-3. The module Printed Circuit Board (PCB) is 0.032" thick with castellated mounting points on the edge. Figure 1-4 is a recommended host PCB footprint for the MRF24J40MD/ME.

The MRF24J40MD has an integrated PCB antenna. For the best performance, follow the mounting details shown in Figure 1-5. It is recommended that the module be mounted on the edge of the host PCB, and an area around the antenna, approximately 1.2", be kept clear of metal objects. A host PCB ground plane around the MRF24J40MD acts as a counterpoise to the PCB antenna. It is recommended to extend the ground plane at least 0.4" around the module.

The MRF24J40ME has 50Ω ultra miniature coaxial (U.FL) connector.

**Caution:** The U.FL connector is fragile and can only tolerate very limited number of insertions.

## 1.3 Soldering Recommendations

The MRF24J40MD/ME module was assembled using a standard lead-free reflow profile. The module is compatible with standard lead-free solder reflow profiles. To avoid damaging the module, the following recommendations are given:

- Refer to the solder paste data sheet for specific reflow profile recommendations
- Use no-clean flux solder paste
- Do not wash as moisture can be trapped under the shield
- Use only one flow. If the PCB requires multiple flows, apply the module on the last flow

FIGURE 1-3: MODULE DETAILS

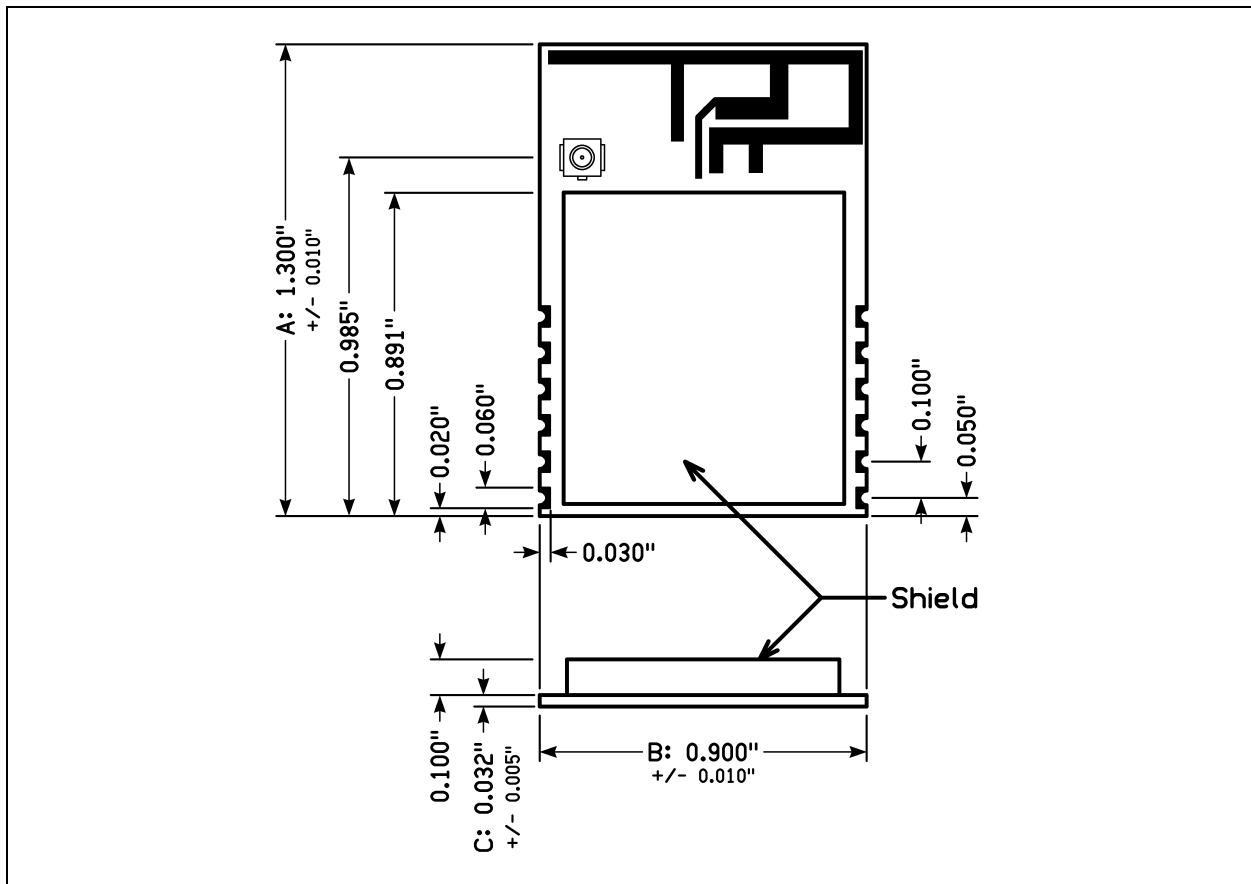

# MRF24J40MD/ME

FIGURE 1-4: RECOMMENDED PCB FOOTPRINT

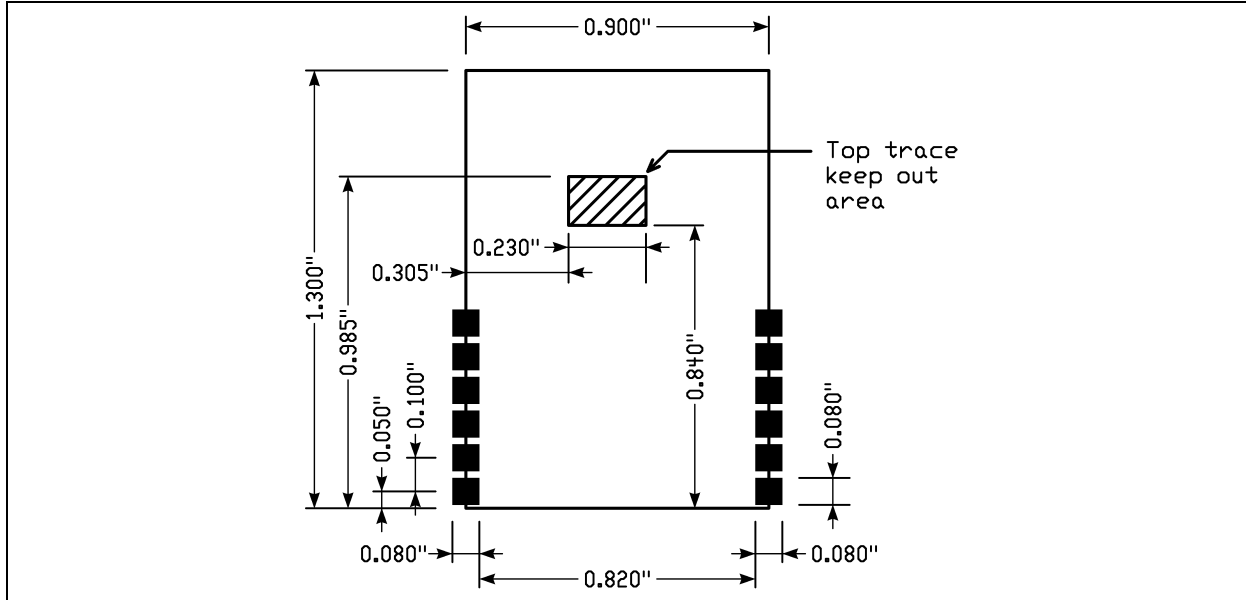
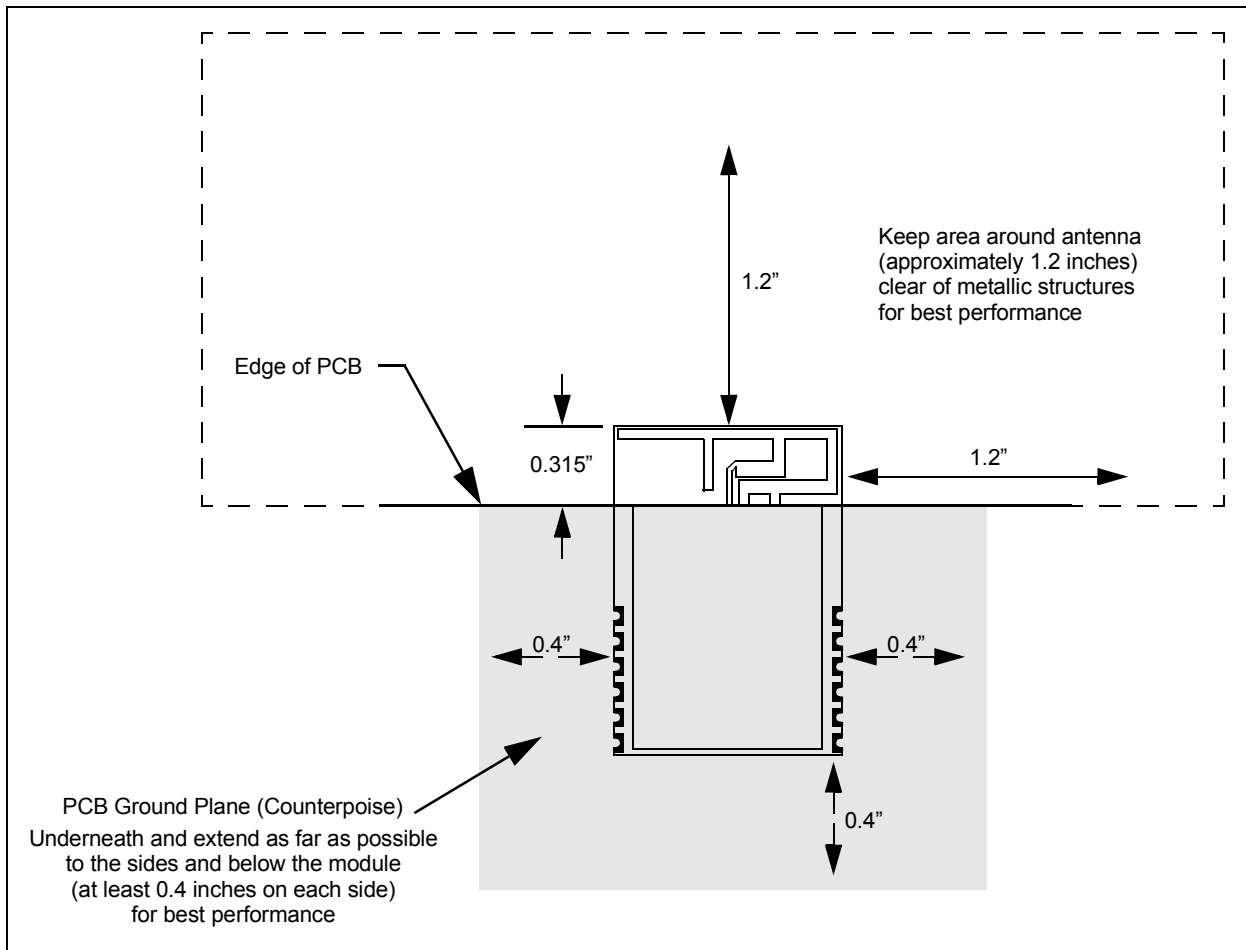

FIGURE 1-5: MOUNTING DETAILS



## 1.4 Operation

The MRF24J40MD/ME module is based on the Microchip Technology MRF24J40 2.4 GHz IEEE 802.15.4 RF Transceiver IC. Serial communication and configuration are documented in the “*MRF24J40 Data Sheet*” (DS39776).

This section emphasizes operational settings that are unique to the MRF24J40MD/ME module design that must be followed for proper operation.

### 1.4.1 PA/LNA CONTROL

Operation of the PA U6 and LNA U1 is controlled by the MRF24J40 internal RF state machine through RF switches, U3 and U4, and the GPIO0, GPIO1 and GPIO2

pins on the MRF24J40. Figure 1-6 shows the PA/LNA block diagram. Figure 2-5 is the schematic diagram for the module.

The internal RF state machine is configured for the PA/LNA Mode by setting TESTMODE (0x22<2:0>) = 111. Pins GPIO0, GPIO1 and GPIO2 control the RF switches, PA and LNA automatically when the MRF24J40 receives and transmits data.

**Note:** A complete explanation of the operation of the PA/LNA control is documented in the “*MRF24J40 Data Sheet*” (DS39776), Section 4.2 “External PA/LNA Control”.

**FIGURE 1-6: PA/LNA BLOCK DIAGRAM**

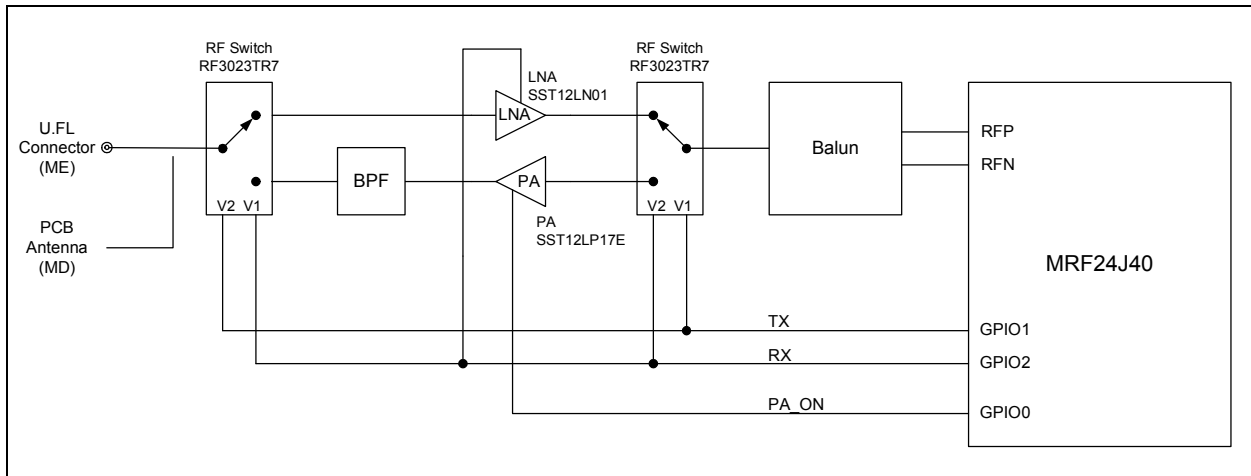

# MRF24J40MD/ME

---

## 1.4.2 ENERGY DETECTION (ED)

Before performing an energy detection (see Section 3.6.1 “RSSI Firmware Request (RSSI Mode 1)” in the “*MRF24J40 Data Sheet*” (DS39776), perform the following steps:

1. Configure the internal RF state machine to normal operation (TESTMODE (0x22F<2:0>) = 000).
2. Configure GPIO2 and GPIO1 direction for output (TRISGP2 (0x34<2>) = 1 and TRISGP1 (0x34<1>) = 1).
3. Set GPIO2 (0x33<2>) = 1 and GPIO1 (0x32<1>) = 0. This enables the LNA and disables the PA.
4. Perform the energy detection following the steps in Section 3.6.1 “RSSI Firmware Request (RSSI Mode 1)” in the “*MRF24J40 Data Sheet*” (DS39776).

<b>Note:</b> The LNA will amplify the received signal. The RSSI value will include the receive signal strength plus the LNA amplification.
--

## 1.4.3 SLEEP

To get the lowest power consumption from the MRF24J40MD/ME module during Sleep, it is necessary to disable the PA, PA voltage regulator and LNA. To do this, perform the following steps:

1. Configure the internal RF state machine to normal operation (TESTMODE (0x22F<2:0>) = 000).
2. Configure the GPIO2, GPIO1 and GPIO0 direction for output (TRISGP2 (0x34<2>) = 1, TRISGP1 (0x34<1>) = 1) = 1 and TRISGP0 (0x34<0>) = 1).
3. Set GPIO2 (0x33<2>) = 0 and GPIO1 (0x32<1>) = 0. This disables the LNA and the PA.
4. Put the MRF24J40 to Sleep following the steps in the “*MRF24J40 Data Sheet*” (DS39776).

When waking the module, re-enable the PA/LNA Mode.



## 1.4.4 TRANSMIT POWER SETTINGS

Table 1-2 lists the power settings in register RCON3 (0x203<7:3>) and the output power at antenna connector J1.

**TABLE 1-2: MRF24J40ME TRANSMIT POWER SETTINGS**

RCON3 (0x203<7:3>)	MRF24J40 Power Setting	Conducted Output Power <sup>(1)</sup> (dBm)
11111	-36.3	-13.6
11110	-34.9	-12.4
11101	-33.7	-11.5
11100	-32.8	-10.7
11011	-31.9	-10.0
11010	-31.2	-9.6
11001	-30.5	-9.2
11000	-30.0	-8.4
10111	-26.3	-1.3
10110	-24.9	-0.7
10101	-23.7	0.1
10100	-22.8	0.5
10011	-21.9	1.0
10010	-21.2	1.3
10001	-20.5	5.8
10000	-20.0	7.0
01111	-16.3	8.1
01110	-14.9	9.0
01101	-13.7	9.7
01100	-12.8	10.4
01011	-11.9	10.9
01010	-11.2	11.3
01001	-10.5	16.0
01000	-10.0	17.2
00111	-6.3	17.9
00110	-4.9	18.5
00101	-3.7	19.0

**Note 1:** Typical output power at antenna connector J1, Channel 11, 50Ω impedance.

**Note:** Refer to [Section 3.0 “Regulatory Approval”](#) for the required maximum power setting necessary to maintain certification requirements for each country the module will be used.

# MRF24J40MD/ME

---

NOTES:

## 2.0 CIRCUIT DESCRIPTION

The MRF24J40MD/ME is a 2.4 GHz IEEE Std. 802.15.4™ compliant surface mount module with integrated crystal, internal voltage regulator, matching circuitry, power amplifier, low noise amplifier with PCB trace antenna (MRF24J40MD) and 50Ω external antenna connector (MRF24J40ME).

The MRF24J40MD/ME module interfaces to many popular Microchip PIC microcontrollers through a 4-wire SPI Interface, interrupt, wake, reset, power and ground. An example application schematic is illustrated in [Figure 2-4](#).

Serial communications and register definitions for the MRF24J40MD/ME module are documented in the “*MRF24J40 Data Sheet*” (DS39776). Refer to this data sheet for specific serial interface protocol and register definitions. Also, see [Section 1.4 “Operation”](#) for specific register settings that are unique to the MRF24J40MD/ME module.

## 2.1 PCB Antenna (MRF24J40MD)

The Printed Circuit Board (PCB) antenna is fabricated on the top copper trace of the module PCB. The layers below the antenna have no copper traces. The ground and power planes under the components serve as a counterpoise to the PCB antenna. Additional ground plane on the host PCB will substantially enhance the performance of the module. For best performance, place the module on the host PCB following the recommendations in [Section 1.2 “Mounting Details”](#).

The PCB antenna was designed and simulated using Ansoft Designer® and HFSS™ 3D full-wave solver software by Ansoft Corporation ([www.ansoft.com](http://www.ansoft.com)) and tested in an anechoic room. The design goal was to create a compact, low-cost antenna with the best radiation pattern. [Figure 2-1](#) shows the simulation drawing and [Figure 2-2](#) and [Figure 2-3](#) show the 2D and 3D radiation patterns, respectively. As shown by the radiation patterns, the performance of the antenna is dependent upon the orientation of the module. The discrete matching circuitry matches the impedance of the antenna with the MRF24J40 transceiver IC.

**FIGURE 2-1: PCB ANTENNA SIMULATION DRAWING**

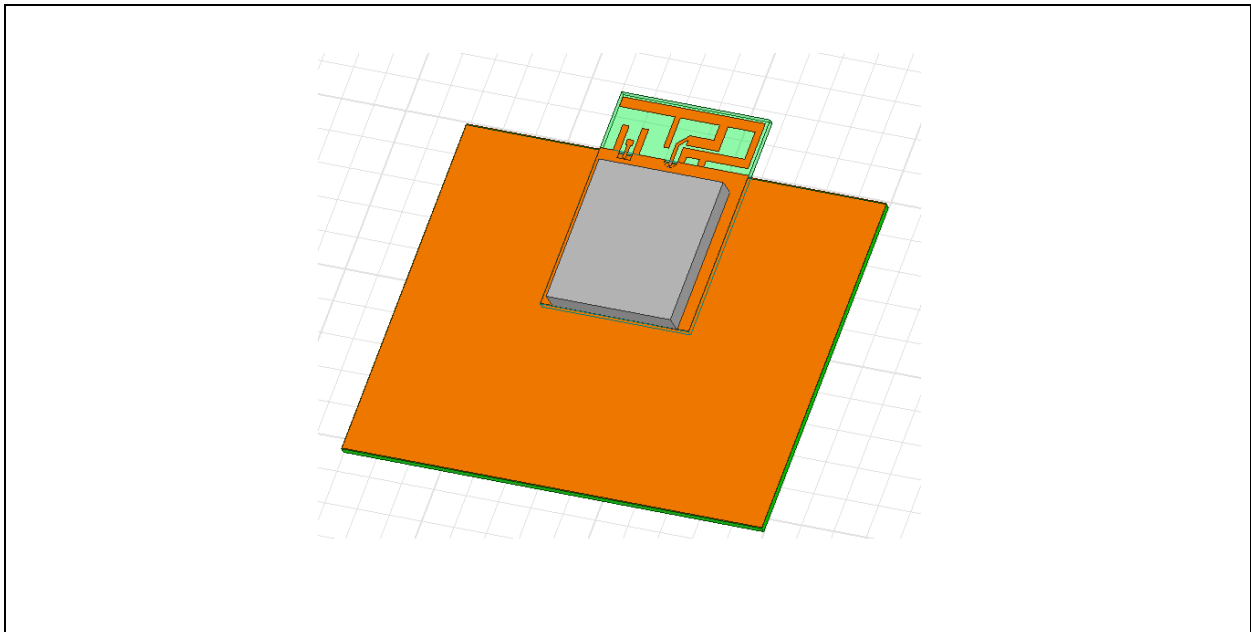

# MRF24J40MD/ME

FIGURE 2-2: SIMULATED 2D RADIATION PATTERN

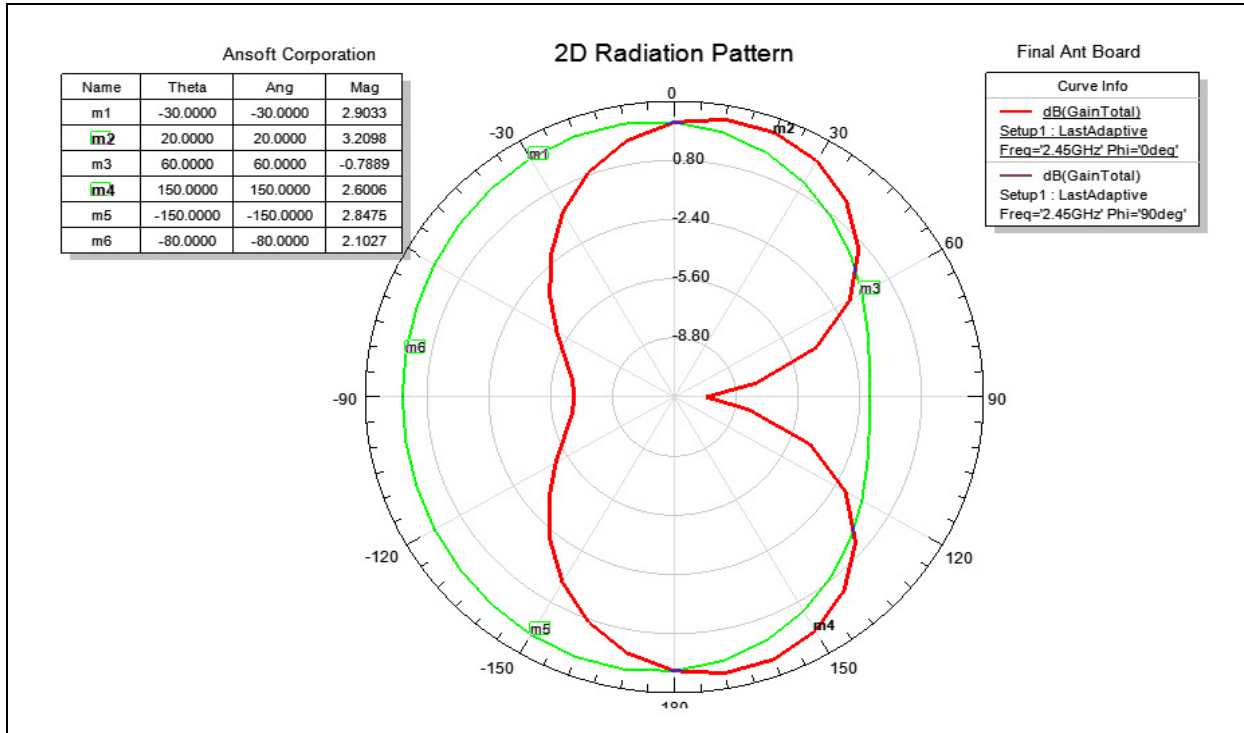
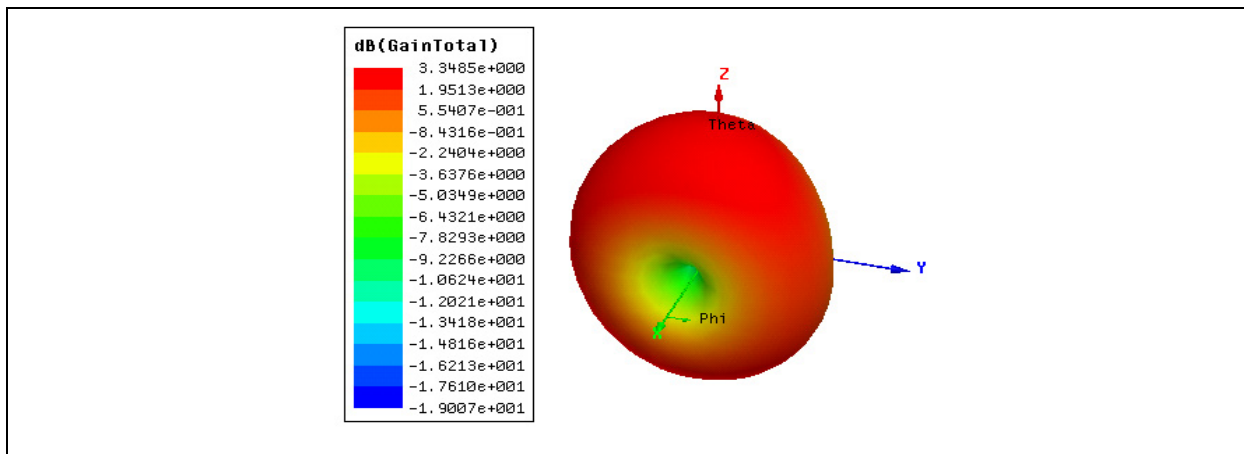

FIGURE 2-3: SIMULATED 3D RADIATION PATTERN



## 2.2 External Antenna (MRF24J40ME)

The MRF24J40ME module has a 50Ω ultra miniature coaxial (U.FL) connector to connect to an external 2.4 GHz antenna.

**Caution:** The U.FL connector is fragile and can only tolerate very limited number of insertions.

Modular certification of the MRF24J40ME module was performed with the external antenna types listed in Table 2-1. An antenna type comprises antennas having similar in-band and out-of-band radiation patterns. Refer to Section 3.0 “Regulatory Approval” for specific regulatory requirements by country.

TABLE 2-1: TESTED EXTERNAL ANTENNA TYPES

Type	Gain
Whip Dipole	5 dBi

**Note 1:** An antenna type comprises antennas having similar in-band and out-of-band radiation patterns.

## 2.3 Module Schematic

A schematic diagram of the module is illustrated in [Figure 2-5](#) and the Bill of Materials (BOM) is shown in [Table 2-2](#).

The MRF24J40MD/ME module is based on the Microchip Technology MRF24J40 IEEE 802.15.4™ 2.4 GHz RF Transceiver IC (U2). The Serial I/O (SCK, SDI, SDO and  $\overline{\text{CS}}$ ),  $\overline{\text{RESET}}$ , WAKE and INT pins are brought out to the module pins. The SDO signal is tri-state buffered by U7 to solve a silicon errata, where the SDO signal does not release to a high-impedance state, after the  $\overline{\text{CS}}$  pin returns to its inactive state.

Crystal, X1, is a 20 MHz crystal with a frequency tolerance of  $\pm 10$  ppm @ 25°C to meet the IEEE Std. 802.15.4 symbol rate tolerance of  $\pm 40$  ppm.

A balun is formed by components: L2, L4, L5, C19, C20, C22 and C43. L2 is also a pull-up for the RFP and RFN pins on the MRF24J40. C19 also act as a DC block capacitor. RF switches, U3 and U4, switch between the power amplifier, U6, when transmitting and low noise amplifier, U1, when receiving. A band-pass filter U5 is placed after the PA U6 to reduce harmonics. The remaining passive components provide bias and decoupling.

**FIGURE 2-4: MRF24J40MD/ME APPLICATION SCHEMATIC**

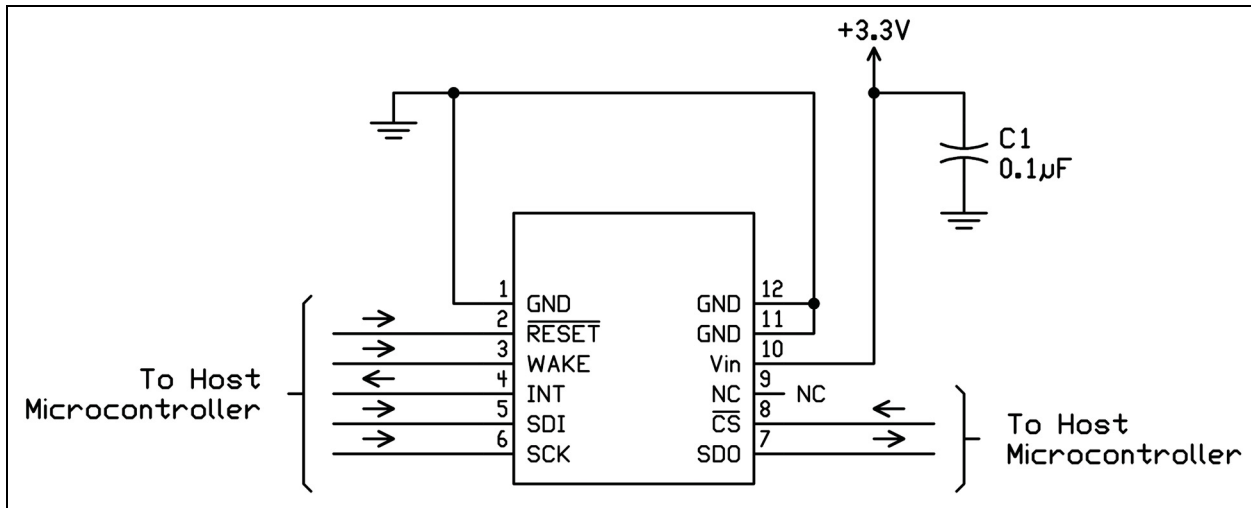



**TABLE 2-2: MRF24J40MD/ME BILL OF MATERIALS**

Designator	Quantity	Value	Manufacturer	Manufacturer PN
C1	1	33 pF	Murata Electronics	GRM1535C1H330JDD5D
C2, C10	2	0.01 uF	Murata Electronics	GRM155R71E103KA01D
C3, C6, C8, C9, C23, C25, C28, C29, C36, C43	10	33 pF	Murata Electronics	GRM1535C1H330JDD5D
C4	11	100 nF	Murata Electronics	GRM155R61A104KA01D
C5	1	1 uF	Murata Electronics	GRM155R60J105KE19D
C7, C15, C16, C17, C18	5	1000 pF	Murata Electronics	GRM155R71H102KA01D
C11, C34, C35	3	0.1 uF	Murata Electronics	GRM155R61A104KA01D
C14, C30	0	Not Populated		
C19, C21	2	1.8 pF	Murata Electronics	GRM1555C1H1R8CA01D
C20, C22	2	0.5 pF	Murata Electronics	GRM1555C1HR50CA01D
C24	1	1 pF	Murata Electronics	GRM1555C1H1R0CA01D
C26	1	2.2 uF	Murata Electronics	GRM188R60J225KE19D
C27	1	0.2 pF	Murata Electronics	GRM1555C1HR20WA01D
C20, C22	2	0.5 pF	Murata Electronics	GRM1555C1HR50BA01D
C19	1	1.8 pF	Murata Electronics	GRM1555C1H1R8BA01D
C21	1	1.5 pF	Murata Electronics	GRM1555C1H1R5BA01D
C31, C42	2	100 pF	Murata Electronics	GRM1555C1H101GA01D
C32, C33	2	18 pF	Murata Electronics	GRM1555C1H180JA01D
C11, C4, C34, C35	4	100 nF	Murata Electronics	GRM155R61A104KA01D
C2, C10	2	10 nF	Murata Electronics	GRM155R71E103KA01D
C1, C3, C6, C8, C9, C23, C28, C29, C36, C37, C38, C43	12	33 pF	Murata Electronics	GRM1535C1H330JDD5D
C7, C15, C16, C17, C18	5	1 nF	Murata Electronics	GRM155R71H102KA01D
C5	1	1 uF	Murata Electronics	GRM155C80G105KE19D
C24	1	1 pF	Murata Electronics	GJM1555C1HR75BB01D
C44	1	1.5 pF	Murata Electronics	GRM1555C1H1R5BA01D
L2, L5	2	4.7 nH	Murata Electronics	LQG15HS4N7S02D
L4	1	3.0 nH	Murata Electronics	LQG15HN3N0S02D
L6	1	2.7 nH	Murata Electronics	LQG15HS2N7S02D
L7	1	0R	Yageo	RC0603JR-0710KL
L8	1	8.2 nH	Murata Electronics	LQW15AN8N2J00D
L10	1	6.8 nH	Murata Electronics	LQG15HS6N8J02D

# MRF24J40MD/ME

TABLE 2-2: MRF24J40MD/ME BILL OF MATERIALS (CONTINUED)

Designator	Quantity	Value	Manufacturer	Manufacturer PN
Q1	1	BSS84	Fairchild Semiconductor	BSS84
Q2	1	2N7002P,215	NXP Semiconductor	2N7002P,215
R1	1	470k	Yageo	RC0402FR-07470KL
R5	1	50R	Yageo	RC0402JR-0751RL
R2, R3, R4, R6, R10	5	0 ohm	Yageo	RC0402JR-070RL
R7, R9	0	Not Populated		
R8	1	5.6 R	Yageo	RC0402JR-075R6L
U1	1	SST12LN01	Microchip	SST12LN01-QU6F
U2	1	MRF24J40	Microchip	MRF24J40-I/ML
U3, U4	2	RF3023	RFMD	RF3023
U5	1	2450BP15B100E	Johanson Technology Inc	2450BP15B100E
U6	1	SST12PL17E	Microchip	SST12PL17E-XX8E
U7	1	NC7SZ125P5X	Fairchild Semiconductor	NC7SZ125P5X
X1	1	20 MHz	Abracon	ABM8-156-20.000MHZ



## 2.4 Printed Circuit Board

The MRF24J40MD/ME module PCB is constructed with high temperature FR4 material, four layers and 0.032" thick. The layers are illustrated in Figure 2-6 through Figure 2-10. The stack up of the PCB is illustrated in Figure 2-11.

FIGURE 2-6: TOP SILK SCREEN

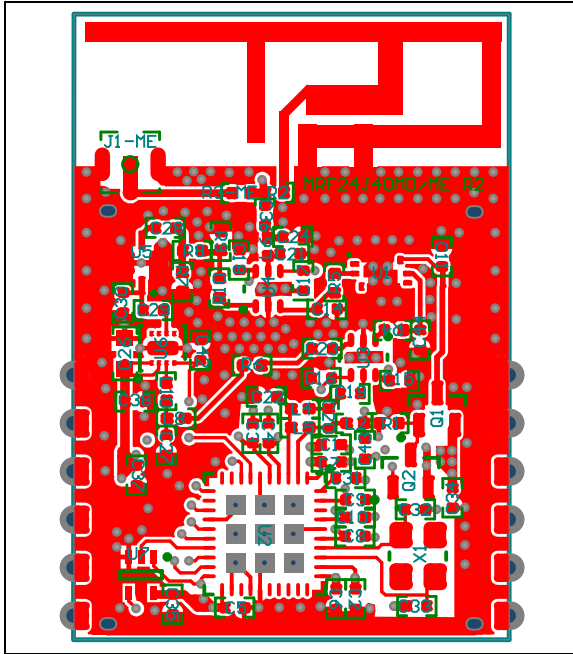

FIGURE 2-7: TOP COPPER

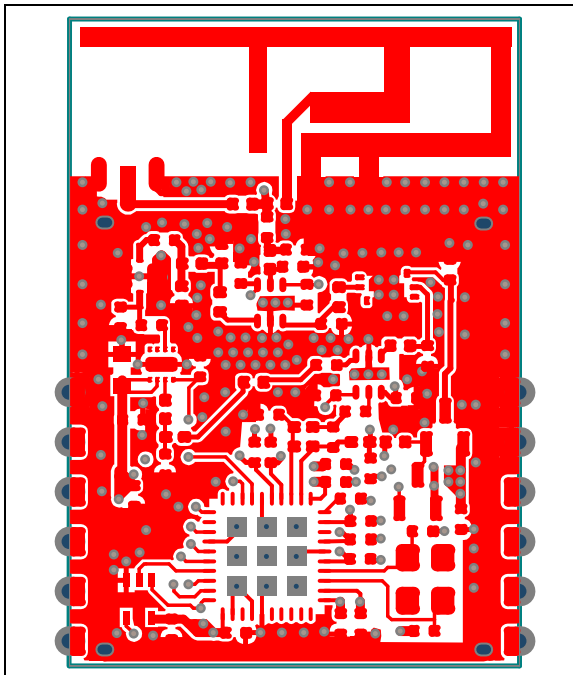

FIGURE 2-8: LAYER 2 – GROUND PLANE

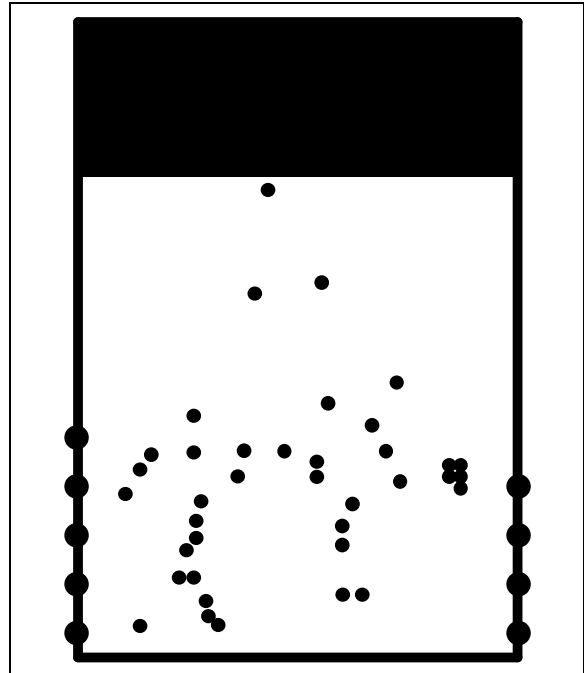
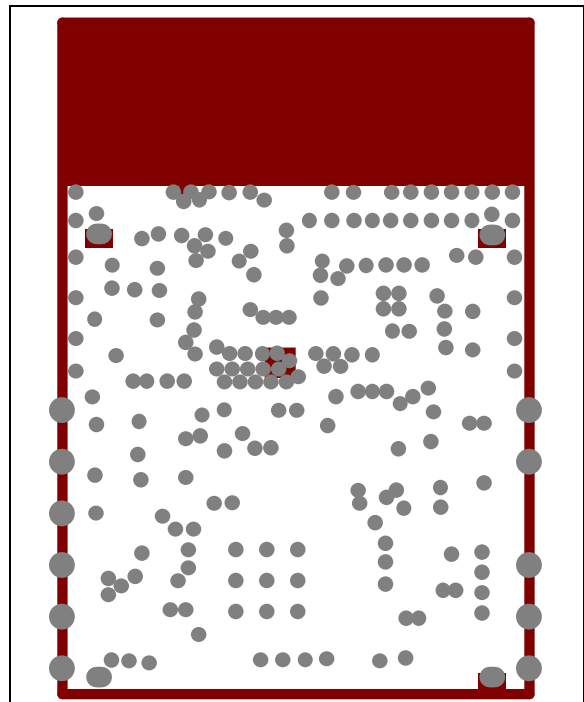
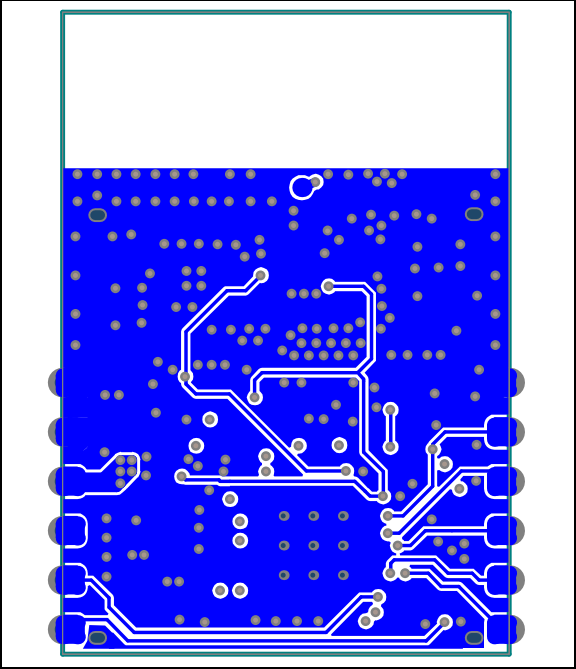

FIGURE 2-9: LAYER 3 – POWER PLANE



# MRF24J40MD/ME

**FIGURE 2-10: BOTTOM COPPER**



**FIGURE 2-11: PCB LAYER STACK UP**

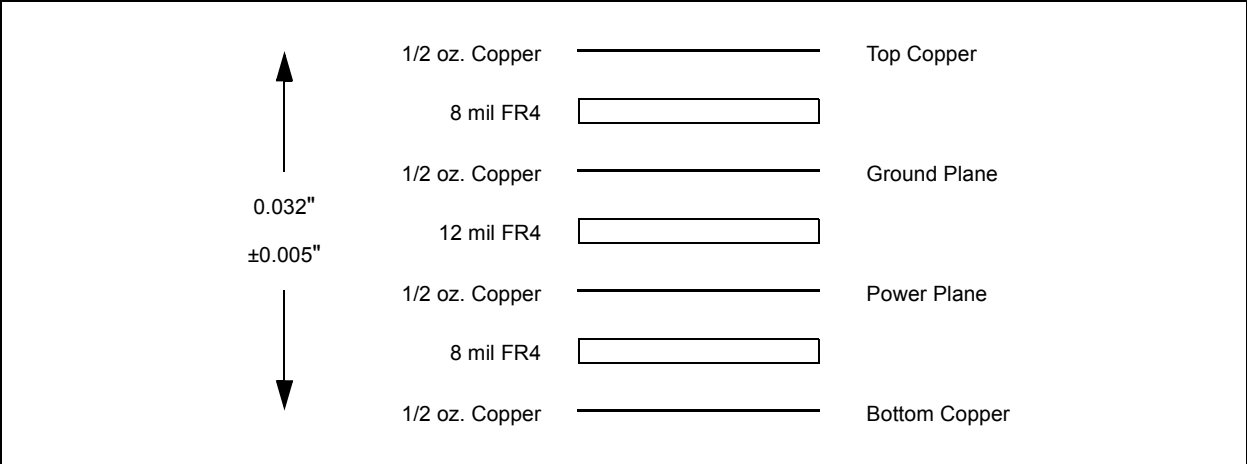

## 3.0 REGULATORY APPROVAL

This section outlines the regulatory information for the MRF24J40MD/ME module for the following countries:

- United States
- Canada
- Europe
- Australia
- New Zealand
- Other Regulatory Jurisdictions

### 3.1 United States

The MRF24J40MD/ME module has received Federal Communications Commission (FCC) CFR47 Telecommunications, Part 15 Subpart C “Intentional Radiators” modular approval in accordance with Part 15.212 Modular Transmitter approval. Modular approval allows the end user to integrate the MRF24J40MD/ME module into a finished product without obtaining subsequent and separate FCC approvals for intentional radiation, provided no changes or modifications are made to the module circuitry. Changes or modifications could void the user's authority to operate the equipment. The end user must comply with all of the instructions provided by the Grantee, which indicate installation and/or operating conditions necessary for compliance.

The finished product is required to comply with all applicable FCC equipment authorizations regulations, requirements and equipment functions not associated with the transmitter module portion. For example, compliance must be demonstrated to regulations for other transmitter components within the host product; to requirements for unintentional radiators (Part 15 Subpart B “Unintentional Radiators”), such as digital devices, computer peripherals, radio receivers, etc.; and to additional authorization requirements for the non-transmitter functions on the transmitter module (i.e., Verification, or Declaration of Conformity) (e.g., transmitter modules may also contain digital logic functions) as appropriate.

#### 3.1.1 LABELING AND USER INFORMATION REQUIREMENTS

The MRF24J40MD/ME module has been labeled with its own FCC ID number, and if the FCC ID is not visible when the module is installed inside another device, then the outside of the finished product into which the module is installed must also display a label referring to the enclosed module. This exterior label can use wording as follows:

Contains Transmitter Module FCC ID:  
W70MRF24J40MDME

or

Contains FCC ID: W70MRF24J40MDME

This device complies with Part 15 of the FCC Rules. Operation is subject to the following two conditions: (1) this device may not cause harmful interference, and (2) this device must accept any interference received, including interference that may cause undesired operation

A user's manual for the product should include the following statement:

This equipment has been tested and found to comply with the limits for a Class B digital device, pursuant to part 15 of the FCC Rules. These limits are designed to provide reasonable protection against harmful interference in a residential installation. This equipment generates, uses and can radiate radio frequency energy, and if not installed and used in accordance with the instructions, may cause harmful interference to radio communications. However, there is no guarantee that interference will not occur in a particular installation. If this equipment does cause harmful interference to radio or television reception, which can be determined by turning the equipment off and on, the user is encouraged to try to correct the interference by one or more of the following measures:

- Reorient or relocate the receiving antenna.
- Increase the separation between the equipment and receiver.
- Connect the equipment into an outlet on a circuit different from that to which the receiver is connected.
- Consult the dealer or an experienced radio/TV technician for help.

Additional information on labeling and user information requirements for Part 15 devices can be found in KDB Publication 784748 available at the FCC Office of Engineering and Technology (OET) Laboratory Division Knowledge Database (KDB) <http://apps.fcc.gov/oetcf/kdb/index.cfm>.

# MRF24J40MD/ME

## 3.1.2 RF EXPOSURE

All transmitters regulated by FCC must comply with RF exposure requirements. OET Bulletin 65, Evaluating Compliance with FCC Guidelines for Human Exposure to Radio Frequency Electromagnetic Fields, provides assistance in determining whether proposed or existing transmitting facilities, operations or devices comply with limits for human exposure to Radio Frequency (RF) fields adopted by the Federal Communications Commission (FCC). The bulletin offers guidelines and suggestions for evaluating compliance.

If appropriate, compliance with exposure guidelines for mobile and unlicensed devices can be accomplished by the use of warning labels and by providing users with information concerning minimum separation distances from transmitting structures and proper installation of antennas.

The following statement must be included as a CAUTION statement in manuals and OEM products to alert users of FCC RF exposure compliance:

To satisfy FCC RF Exposure requirements for mobile and base station transmission devices, a separation distance of 20 cm or more should be maintained between the antenna of this device and persons during operation. To ensure compliance, operation at closer than this distance is not recommended.

The antenna(s) used for this transmitter must not be co-located or operating in conjunction with any other antenna or transmitter.

If the MRF24J40MD/ME module is used in a portable application (i.e., the antenna is less than 20 cm from persons during operation), the integrator is responsible for performing Specific Absorption Rate (SAR) testing in accordance with FCC rules 2.1091.

## 3.1.3 APPROVED EXTERNAL ANTENNA TYPES

To maintain modular approval in the United States, only the antenna types that have been tested shall be used. It is permissible to use different antenna manufacturer provided the same antenna type and antenna gain (equal to or less than) is used.

Testing of the MRF24J40MD/ME module was performed with the antenna types listed in [Table 2-1 Tested External Antenna Types](#).

## 3.1.4 HELPFUL WEB SITES

Federal Communications Commission (FCC)  
<http://www.fcc.gov>

FCC Office of Engineering and Technology (OET) Laboratory Division Knowledge Database (KDB):  
<http://apps.fcc.gov/oetcf/kdb/index.cfm>

## 3.2 Canada

The MRF24J40MD/ME module has been certified for use in Canada under Industry Canada (IC) Radio Standards Specification (RSS) RSS-210 and RSSGen. Modular approval permits the installation of a module in a host device without the need to recertify the device.

### 3.2.1 LABELING AND USER INFORMATION REQUIREMENTS

Labeling Requirements for the Host Device (from Section 3.2.1, RSS-Gen, Issue 3, December 2010): The host device shall be properly labeled to identify the module within the host device.

The Industry Canada certification label of a module shall be clearly visible at all times when installed in the host device, otherwise the host device must be labeled to display the Industry Canada certification number of the module, preceded by the words "Contains transmitter module", or the word "Contains", or similar wording expressing the same meaning, as follows:

Contains transmitter module IC: 7693A-24J40MDME

User Manual Notice for License-Exempt Radio Apparatus (from Section 7.1.3 RSS-Gen, Issue 3, December 2010): User manuals for license-exempt radio apparatus shall contain the following or equivalent notice in a conspicuous location in the user manual or alternatively on the device or both:

This device complies with Industry Canada license-exempt RSS standard(s). Operation is subject to the following two conditions: (1) this device may not cause interference, and (2) this device must accept any interference, including interference that may cause undesired operation of the device.

Le présent appareil est conforme aux CNR d'Industrie Canada applicables aux appareils radio exempts de licence. L'exploitation est autorisée aux deux conditions suivantes: (1) l'appareil ne doit pas produire de brouillage, et (2) l'utilisateur de l'appareil doit accepter tout brouillage radioélectrique subi, même si le brouillage est susceptible d'en compromettre le fonctionnement.

Transmitter Antenna (from Section 7.1.2 RSS-Gen, Issue 3, December 2010): User manuals for transmitters shall display the following notice in a conspicuous location:

Under Industry Canada regulations, this radio transmitter may only operate using an antenna of a type and maximum (or lesser) gain approved for the transmitter by Industry Canada. To reduce potential radio interference to other users, the antenna type and its gain should be so chosen that the equivalent isotropically radiated power (e.i.r.p.) is not more than that necessary for successful communication.

Conformément à la réglementation d'Industrie Canada, le présent émetteur radio peut fonctionner avec une antenne d'un type et d'un gain maximal (ou inférieur) approuvé pour l'émetteur par Industrie Canada. Dans le but de réduire les risques de brouillage radioélectrique à l'intention des autres utilisateurs, il faut choisir le type d'antenne et son gain de sorte que la puissance isotrope rayonnée équivalente (p.i.r.e.) ne dépasse pas l'intensité nécessaire à l'établissement d'une communication satisfaisante.

The above notice may be affixed to the device instead of displayed in the user manual.

User manuals for transmitters equipped with detachable antennas shall also contain the following notice in a conspicuous location.

This radio transmitter (identify the device by certification number, or model number if Category II) has been approved by Industry Canada to operate with the antenna types listed below with the maximum permissible gain and required antenna impedance for each antenna type indicated. Antenna types not included in this list, having a gain greater than the maximum gain indicated for that type, are strictly prohibited for use with this device.

Conformément à la réglementation d'Industrie Canada, le présent émetteur radio peut fonctionner avec une antenne d'un type et d'un gain maximal (ou inférieur) approuvé pour l'émetteur par Industrie Canada. Dans le but de réduire les risques de brouillage radioélectrique à l'intention des autres utilisateurs, il faut choisir le type d'antenne et son gain de sorte que la puissance isotrope rayonnée équivalente (p.i.r.e.) ne dépasse pas l'intensité nécessaire à l'établissement d'une communication satisfaisante.

Immediately following the above notice, the manufacturer shall provide a list of all antenna types approved for use with the transmitter, indicating the maximum permissible antenna gain (in dBi) and required impedance for each.

## 3.2.2 APPROVED EXTERNAL ANTENNA TYPES

Transmitter Antenna (from Section 7.1.2 RSS-Gen, Issue 3, December 2010):

The MRF24J40MD/ME module can only be sold or operated with antennas with which it was approved. Transmitter may be approved with multiple antenna types. An antenna type comprises antennas having similar in-band and out-of-band radiation patterns. Testing shall be performed using the highest gain antenna of each combination of transmitter and antenna type for which approval is being sought, with the transmitter output power set at the maximum level. Any antenna of the same type having equal or lesser gain as an antenna that had been successfully tested with the transmitter, will also be considered approved with the transmitter, and may be used and marketed with the transmitter.

When a measurement at the antenna connector is used to determine RF output power, the effective gain of the device's antenna shall be stated, based on measurement or on data from the antenna manufacturer. For transmitters of output power greater than 10 milliwatts, the total antenna gain shall be added to the measured RF output power to demonstrate compliance to the specified radiated power limits.

Testing of the MRF24J40MD/ME module was performed with the antenna types listed in [Table 2-1 Tested External Antenna Types](#)

## 3.2.3 HELPFUL WEB SITES

Industry Canada: <http://www.ic.gc.ca/>

# MRF24J40MD/ME

## 3.3 Europe

The MRF24J40MD/ME module is an R&TTE Directive assessed radio module that is CE marked and has been manufactured and tested with the intention of being integrated into a final product.

The MRF24J40MD/ME module has been tested to R&TTE Directive 1999/5/EC Essential Requirements for Health and Safety (Article (3.1(a)), Electromagnetic Compatibility (EMC) (Article 3.1(b)), and Radio (Article 3.2) and are summarized in Table 3-1: European Compliance Testing. A Notified Body Opinion has also been issued. All test reports are available on the MRF24J40MD/ME product web page at <http://www.microchip.com>.

The R&TTE Compliance Association provides guidance on modular devices in document Technical Guidance Note 01 available at [http://www.rteca.com/html/download\\_area.htm](http://www.rteca.com/html/download_area.htm).

**Note:** To maintain conformance to the testing listed in Table 3-1: European Compliance Testing, the module shall be installed in accordance with the installation instructions in this data sheet and shall not be modified.

When integrating a radio module into a completed product the integrator becomes the manufacturer of the final product and is therefore responsible for demonstrating compliance of the final product with the essential requirements of the R&TTE Directive.

### 3.3.1 LABELING AND USER INFORMATION REQUIREMENTS

The label on the final product which contains the MRF24J40MD/ME module must follow CE marking requirements. The R&TTE Compliance Association Technical Guidance Note 01 provides guidance on final product CE marking.

**TABLE 3-1: EUROPEAN COMPLIANCE TESTING**

Certification	Standards	Article	Laboratory	Report Number	Date
Safety	EN 60950-1:2006+A11:2009+A1:2010	(3.1(a))			
Health	EN 50371:2002-03				
EMC	EN 301 489-1 V1.8.1 (2008-04)	(3.1(b))			
	EN 301 489-17 V2.1.1 (2009-05)				
Radio	EN 300 328 V1.7.1 (2006-10)	(3.2)			
Notified Body Opinion					
DoC					

### 3.3.2 EXTERNAL ANTENNA REQUIREMENTS

From R&TTE Compliance Association document Technical Guidance Note 01:

Provided the integrator installing an assessed radio module with an integral or specific antenna and installed in conformance with the radio module manufacturer's installation instructions requires no further evaluation under Article 3.2 of the R&TTE Directive and does not require further involvement of an R&TTE Directive Notified Body for the final product. [Section 2.2.4]

The European Compliance Testing listed in Table 3-1 was performed using the antenna types listed in [Table 2-1 Tested External Antenna Types](#).

### 3.3.3 HELPFUL WEB SITES

A document that can be used as a starting point in understanding the use of Short Range Devices (SRD) in Europe is the European Radio Communications Committee (ERC) Recommendation 70-03 E, which can be downloaded from the European Radio Communications Office (ERO) at: <http://www.ero.dk/>.

Additional helpful web sites are:

- Radio and Telecommunications Terminal Equipment (R&TTE): [http://ec.europa.eu/enterprise/rtte/index\\_en.htm](http://ec.europa.eu/enterprise/rtte/index_en.htm)
- European Conference of Postal and Telecommunications Administrations (CEPT): <http://www.cept.org>
- European Telecommunications Standards Institute (ETSI): <http://www.etsi.org>
- European Radio Communications Office (ERO): <http://www.ero.dk>
- The Radio and Telecommunications Terminal Equipment Compliance Association (R&TTE CA): <http://www.rteca.com/>



## 3.4 Australia

The Australia radio regulations do not provide a modular approval policy similar to the United States (FCC) and Canada (IC). However, MRF24J40MD/ME module RF transmitter test reports can be used in part to demonstrate compliance in accordance with ACMA Radio communications "Short Range Devices" Standard 2004 (The Short Range Devices standard calls up the AS/NZS 4268:2008 industry standard). The MRF24J40MD/ME module test reports can be used as part of the product certification and compliance folder. For more information on the RF transmitter test reports, contact Microchip Technology Australia sales office.

To meet overall Australian final product compliance, the developer must construct a compliance folder containing all relevant compliance test reports e.g. RF, EMC, electrical safety and DoC (Declaration of Conformity) etc. It is the responsibility of the integrator to know what is required in the compliance folder for ACMA compliance. All test reports are available on the MRF24J40MD/ME product web page at <http://www.microchip.com>. For more information on Australia compliance, refer to the Australian Communications and Media Authority web site <http://www.acma.gov.au/>.

### 3.4.1 EXTERNAL ANTENNA REQUIREMENTS

The compliance testing listed in [Table 3-1](#) was performed using the antenna types listed in [Table 2-1](#) Tested External Antenna Types.

### 3.4.2 HELPFUL WEB SITES

The Australian Communications and Media Authority: [www.acma.gov.au/](http://www.acma.gov.au/).

## 3.5 New Zealand

The New Zealand radio regulations do not provide a modular approval policy similar to the United States (FCC) and Canada (IC). However, MRF24J40MD/ME module RF transmitter test reports can be used in part to demonstrate compliance against the New Zealand "General User Radio License for Short Range Devices". New Zealand Radio communications (Radio Standards) Notice 2010 calls up the AS / NZS 4268:2008 industry standard. The MRF24J40MD/ME module test reports can be used as part of the product certification and compliance folder. All test reports are available on the MRF24J40MD/ME product web page at <http://www.microchip.com>. For more information on the RF transmitter test reports, contact Microchip Technology sales office.

Information on the New Zealand short range devices license can be found in the following web links:

<http://www.rsm.govt.nz/cms/licensees/types-of-licence/general-user-licences/short-range-devices>

and

<http://www.rsm.govt.nz/cms/policy-and-planning/spectrum-policy-overview/legislation/gazette-notices/product-compliance/radiocommunications-radiostandards-notice-2010>.

To meet overall New Zealand final product compliance, the developer must construct a compliance folder containing all relevant compliance test reports e.g. RF, EMC, electrical safety and DoC (Declaration of Conformity) etc. It is the responsibility of the developer to know what is required in the compliance folder for New Zealand Radio communications. For more information on New Zealand compliance, refer to the web site <http://www.rsm.govt.nz/>.

### 3.5.1 EXTERNAL ANTENNA REQUIREMENTS

The compliance testing listed in [Table 3-1](#) was performed using the antenna types listed in [Table 2-1](#) Tested External Antenna Types.

### 3.5.2 HELPFUL WEB SITES

Radio Spectrum Ministry of Economic Development: <http://www.rsm.govt.nz/>.

## 3.6 Other Regulatory Jurisdictions

Should other regulatory jurisdiction certification be required by the customer, or the customer need to recertify the module for other reasons, the MRF24J40 Radio Utility Driver Program (AN1192) can be used to control the module.

# MRF24J40MD/ME

---

NOTES:



## 4.0 ELECTRICAL CHARACTERISTICS

**TABLE 4-1: RECOMMENDED OPERATING CONDITIONS**

Parameters	Min	Typ	Max	Units
Ambient Operating Temperature	-40	—	+85	°C
Supply Voltage for RF, Analog and Digital Circuits	3.0	—	3.6	V
Supply Voltage for Digital I/O	3.0	3.3	3.6	V
Input High Voltage (V <sub>IH</sub> )	0.5 x V <sub>DD</sub>	—	V <sub>DD</sub> + 0.3	V
Input Low Voltage (V <sub>IL</sub> )	-0.3	—	0.2 x V <sub>DD</sub>	V

**TABLE 4-2: CURRENT CONSUMPTION**

(T<sub>A</sub> = 25°C, V<sub>DD</sub> = 3.3V)

Chip Mode	Condition	Min	Typ	Max	Units
Sleep	Sleep Clock and PA voltage regulator Disabled	—	10 μA	—	μA
Tx	At Maximum Output Power	—	140 mA	—	mA
Rx	—	—	25 mA	—	mA

**TABLE 4-3: RECEIVER AC CHARACTERISTICS**

Typical values are at T<sub>A</sub> = 25°C, V<sub>DD</sub> = 3.3V, LO Frequency = 2.445 GHz

Parameters	Condition	Min	Typ	Max	Units
RF Input Frequency	Compatible to IEEE Std. 802.15.4™, 2003	2.405	—	2.480	GHz
RF Sensitivity	—	—	-104	—	dBm
Maximum RF Input	50Ω	—	—	-23	dBm
LO Leakage	Measured at Balun Matching Network Input at Frequency, 2.405 GHz – 2.48 GHz	—	-60	—	dBm
Input Return Loss	50Ω	-8	-12	—	dB
Noise Figure (including matching)	—	—	1.8	—	dB
Adjacent Channel Rejection	@ ±5 MHz	30	—	—	dB
Alternate Channel Rejection	@ ±10 MHz	40	—	—	dB
RSSI Range	—	—	50	—	dB
RSSI Error	—	-5	—	5	dB

# MRF24J40MD/ME

**TABLE 4-4: TRANSMITTER AC CHARACTERISTICS**

Typical values are at TA = 25°C, VDD = 3.3V, LO Frequency = 2.445 GHz

Parameters	Condition	Min	Typ	Max	Units
RF Carrier Frequency	—	2.405	—	2.475	GHz
Maximum RF Output Power	50Ω	—	19 <sup>(1)</sup>	—	dBm
RF Output Power Control Range	—	—	45	—	dB
Tx Gain Control Resolution	Programmed by Register	—	1.25	—	dB
Carrier Suppression	—	—	-30	—	dBc
Tx Spectrum Mask for O-QPSK Signal	Offset Frequency >3.5 MHz, at 0 dBm Output Power	-33	—	—	dBm
Tx EVM	—	—	15	—	%

**Note 1:** Conducted output power at antenna connector J1.

## APPENDIX A: MIGRATING FROM MRF24J40MB OR MRF24J40MC TO MRF24J40MD/ME MODULE

### A.1 Introduction

This appendix assists in migrating designs from the MRF24J40MB or MRF24J40MC to the MRF24J40MD/ME module.

### A.2 Background

The Power Amplifier (PA) and Low-Noise Amplifier (LNA) used in the MRF24J40MB and MRF24J40MC modules were discontinued by the manufacturer. This required a redesign of the modules with new components. The MRF24J40MD/ME module was designed with the goal of requiring minimal changes when migrating from the MRF24J40MB or MRF24J40MC module.

### A.3 Circuit Description

The MRF24J40MD/ME module was designed with the SST12LP17E Power Amplifier (PA) and SST12LN01 Low-Noise Amplifier (LNA). Control of the PA and LNA by the MRF24J40 is the same for all modules. GPIO0, GPIO1, and GPIO2 sequence the PA and LNA during transmit and receive by the MRF24J40. Refer to [Section 1.4.1 “PA/LNA Control”](#) for more information.

The MRF24J40MD/ME has the same physical footprint and pin out.

The PCB trace antenna is the same for both the MRF24J40MD and MRF24J40MB modules.

The external antenna connector, U.FL, is the same for both the MRF24J40ME and MRF24J40MC modules.

### A.4 Regulatory Approval

Due to the requirement for a redesigned module with new RF components, new regulatory certifications for the United States (FCC), Canada (IC) and Europe were performed.

When migrating from the MRF24J40MB or MRF24J40MC module to the MRF24J40MD/ME module, the new FCC ID and IC numbers will have to be displayed on the outside of the finished product. Refer to [Section 3.1.1 “Labeling and User Information Requirements”](#) for the United States and [Section 3.2.1 “Labeling and User Information Requirements”](#) for Canada.

For Europe, the R&TTE Directive will have to be assessed using the new reports listed in [Table 3-1](#).

For Australia, product certification and compliance folder should be re-assessed.

### A.5 Electrical Characteristics Comparison

This section helps compare electrical characterization values between modules.

**TABLE A-1: CURRENT CONSUMPTION COMPARISON**

TA = 25°C, VDD = 3.3V

Chip Mode	Condition	MRF24J40MB (Typ)	MRF24J40MC (Typ)	MRF24J40MD/ME (Typ)	Units
Sleep	Sleep Clock Disabled	210	12	10	uA
Tx	At Maximum Output Power	130	120	140	mA
Rx	—	25	25	32	mA

# MRF24J40MD/ME

**TABLE A-2: OUTPUT POWER COMPARISON**

TA = 25°C, VDD = 3.3V

RFCON3 (0x203<7:3>)	MRF24J40 Power Setting	MRF24J40MB Output Power (dBm)	MRF24J40MC Output Power (dBm)	MRF24J40MD/ME Output Power (dBm)
11111	-36.3	-7.0	-26.4	-13.6
11110	-34.9	-6.5	-25.2	-12.4
11101	-33.7	-5.6	-24.1	-11.5
11100	-32.8	-4.8	-23.4	-10.7
11011	-31.9	-4.1	-22.7	-10.0
11010	-31.2	-3.5	-22.4	-9.6
11001	-30.5	-3.2	-21.9	-9.2
11000	-30.0	2.4	-21.6	-3.4
10111	-26.3	4.6	-15.7	-1.3
10110	-24.9	5.3	-14.5	-0.7
10101	-23.7	5.9	-13.7	0.1
10100	-22.8	6.6	-12.9	0.5
10011	-21.9	7.0	-12.3	1.0
10010	-21.2	7.4	-11.8	1.3
10001	-20.5	11.7	-11.5	5.8
10000	-20.0	12.8	-11.1	7.0
01111	-16.3	13.7	-6.6	8.1
01110	-14.9	14.5	-5.5	9.0
01101	-13.7	15.0	-4.7	9.7
01100	-12.8	15.6	-4.0	10.4
01011	-11.9	16.0	-3.4	10.9
01010	-11.2	16.3	-2.9	11.3
01001	-10.5	18.6	-2.5	16.0
01000	-10.0	19.0	-2.0	17.2
00111	-6.3	19.4	10.7	17.9
00110	-4.9	19.6	18.0	18.5
00101	-3.7	19.8	18.5	19.0

**Note 1:** Conducted output power, channel 11, 50 ohm impedance.

**Note:** Refer to [Section 3.0](#) “Regulatory Approval” for the required maximum power setting necessary to maintain certification requirements for each country the module will be used.

## APPENDIX B: REVISION HISTORY

### Revision A (March 2014)

This is the initial release of the document.

# MRF24J40MD/ME

---

NOTES:

## THE MICROCHIP WEB SITE

Microchip provides online support via our WWW site at [www.microchip.com](http://www.microchip.com). This web site is used as a means to make files and information easily available to customers. Accessible by using your favorite Internet browser, the web site contains the following information:

- **Product Support** – Data sheets and errata, application notes and sample programs, design resources, user's guides and hardware support documents, latest software releases and archived software
- **General Technical Support** – Frequently Asked Questions (FAQ), technical support requests, online discussion groups, Microchip consultant program member listing
- **Business of Microchip** – Product selector and ordering guides, latest Microchip press releases, listing of seminars and events, listings of Microchip sales offices, distributors and factory representatives

## CUSTOMER CHANGE NOTIFICATION SERVICE

Microchip's customer notification service helps keep customers current on Microchip products. Subscribers will receive e-mail notification whenever there are changes, updates, revisions or errata related to a specified product family or development tool of interest.

To register, access the Microchip web site at [www.microchip.com](http://www.microchip.com). Under "Support", click on "Customer Change Notification" and follow the registration instructions.

## CUSTOMER SUPPORT

Users of Microchip products can receive assistance through several channels:

- Distributor or Representative
- Local Sales Office
- Field Application Engineer (FAE)
- Technical Support

Customers should contact their distributor, representative or field application engineer (FAE) for support. Local sales offices are also available to help customers. A listing of sales offices and locations is included in the back of this document.

**Technical support is available through the web site at: <http://microchip.com/support>**





---

**Note the following details of the code protection feature on Microchip devices:**

- Microchip products meet the specification contained in their particular Microchip Data Sheet.
- Microchip believes that its family of products is one of the most secure families of its kind on the market today, when used in the intended manner and under normal conditions.
- There are dishonest and possibly illegal methods used to breach the code protection feature. All of these methods, to our knowledge, require using the Microchip products in a manner outside the operating specifications contained in Microchip's Data Sheets. Most likely, the person doing so is engaged in theft of intellectual property.
- Microchip is willing to work with the customer who is concerned about the integrity of their code.
- Neither Microchip nor any other semiconductor manufacturer can guarantee the security of their code. Code protection does not mean that we are guaranteeing the product as “unbreakable.”

Code protection is constantly evolving. We at Microchip are committed to continuously improving the code protection features of our products. Attempts to break Microchip's code protection feature may be a violation of the Digital Millennium Copyright Act. If such acts allow unauthorized access to your software or other copyrighted work, you may have a right to sue for relief under that Act.

---

Information contained in this publication regarding device applications and the like is provided only for your convenience and may be superseded by updates. It is your responsibility to ensure that your application meets with your specifications. MICROCHIP MAKES NO REPRESENTATIONS OR WARRANTIES OF ANY KIND WHETHER EXPRESS OR IMPLIED, WRITTEN OR ORAL, STATUTORY OR OTHERWISE, RELATED TO THE INFORMATION, INCLUDING BUT NOT LIMITED TO ITS CONDITION, QUALITY, PERFORMANCE, MERCHANTABILITY OR FITNESS FOR PURPOSE. Microchip disclaims all liability arising from this information and its use. Use of Microchip devices in life support and/or safety applications is entirely at the buyer's risk, and the buyer agrees to defend, indemnify and hold harmless Microchip from any and all damages, claims, suits, or expenses resulting from such use. No licenses are conveyed, implicitly or otherwise, under any Microchip intellectual property rights.

#### **Trademarks**

The Microchip name and logo, the Microchip logo, dsPIC, FlashFlex, KEELOQ, KEELOQ logo, MPLAB, PIC, PICmicro, PICSTART, PIC<sup>32</sup> logo, rPIC, SST, SST Logo, SuperFlash and UNI/O are registered trademarks of Microchip Technology Incorporated in the U.S.A. and other countries.

FilterLab, Hampshire, HI-TECH C, Linear Active Thermistor, MTP, SEEVAL and The Embedded Control Solutions Company are registered trademarks of Microchip Technology Incorporated in the U.S.A.

Silicon Storage Technology is a registered trademark of Microchip Technology Inc. in other countries.

Analog-for-the-Digital Age, Application Maestro, BodyCom, chipKIT, chipKIT logo, CodeGuard, dsPICDEM, dsPICDEM.net, dsPICworks, dsSPEAK, ECAN, ECONOMONITOR, FanSense, HI-TIDE, In-Circuit Serial Programming, ICSP, Mindi, MiWi, MPASM, MPF, MPLAB Certified logo, MPLIB, MPLINK, mTouch, Omniclient Code Generation, PICC, PICC-18, PICDEM, PICDEM.net, PICkit, PICtail, REAL ICE, rLAB, Select Mode, SQI, Serial Quad I/O, Total Endurance, TSHARC, UniWinDriver, WiperLock, ZENA and Z-Scale are trademarks of Microchip Technology Incorporated in the U.S.A. and other countries.

SQTP is a service mark of Microchip Technology Incorporated in the U.S.A.

GestIC and ULPP are registered trademarks of Microchip Technology Germany II GmbH & Co. KG, a subsidiary of Microchip Technology Inc., in other countries.

All other trademarks mentioned herein are property of their respective companies.

© 2014, Microchip Technology Incorporated, Printed in the U.S.A., All Rights Reserved.

 Printed on recycled paper.

ISBN: 978-1-63276-044-9

**QUALITY MANAGEMENT SYSTEM**  
**CERTIFIED BY DNV**  
**== ISO/TS 16949 ==**

*Microchip received ISO/TS-16949:2009 certification for its worldwide headquarters, design and wafer fabrication facilities in Chandler and Tempe, Arizona; Gresham, Oregon and design centers in California and India. The Company's quality system processes and procedures are for its PIC® MCUs and dsPIC® DSCs, KEELOQ® code hopping devices, Serial EEPROMs, microperipherals, nonvolatile memory and analog products. In addition, Microchip's quality system for the design and manufacture of development systems is ISO 9001:2000 certified.*



# MICROCHIP

## Worldwide Sales and Service

### AMERICAS

**Corporate Office**  
2355 West Chandler Blvd.  
Chandler, AZ 85224-6199  
Tel: 480-792-7200  
Fax: 480-792-7277  
Technical Support:  
<http://www.microchip.com/support>  
Web Address:  
[www.microchip.com](http://www.microchip.com)

**Atlanta**  
Duluth, GA  
Tel: 678-957-9614  
Fax: 678-957-1455

**Austin, TX**  
Tel: 512-257-3370

**Boston**  
Westborough, MA  
Tel: 774-760-0087  
Fax: 774-760-0088

**Chicago**  
Itasca, IL  
Tel: 630-285-0071  
Fax: 630-285-0075

**Cleveland**  
Independence, OH  
Tel: 216-447-0464  
Fax: 216-447-0643

**Dallas**  
Addison, TX  
Tel: 972-818-7423  
Fax: 972-818-2924

**Detroit**  
Novi, MI  
Tel: 248-848-4000

**Houston, TX**  
Tel: 281-894-5983

**Indianapolis**  
Noblesville, IN  
Tel: 317-773-8323  
Fax: 317-773-5453

**Los Angeles**  
Mission Viejo, CA  
Tel: 949-462-9523  
Fax: 949-462-9608

**New York, NY**  
Tel: 631-435-6000

**San Jose, CA**  
Tel: 408-735-9110

**Canada - Toronto**  
Tel: 905-673-0699  
Fax: 905-673-6509

### ASIA/PACIFIC

**Asia Pacific Office**  
Suites 3707-14, 37th Floor  
Tower 6, The Gateway  
Harbour City, Kowloon  
Hong Kong  
Tel: 852-2943-5100  
Fax: 852-2401-3431

**Australia - Sydney**  
Tel: 61-2-9868-6733  
Fax: 61-2-9868-6755

**China - Beijing**  
Tel: 86-10-8569-7000  
Fax: 86-10-8528-2104

**China - Chengdu**  
Tel: 86-28-8665-5511  
Fax: 86-28-8665-7889

**China - Chongqing**  
Tel: 86-23-8980-9588  
Fax: 86-23-8980-9500

**China - Hangzhou**  
Tel: 86-571-8792-8115  
Fax: 86-571-8792-8116

**China - Hong Kong SAR**  
Tel: 852-2943-5100  
Fax: 852-2401-3431

**China - Nanjing**  
Tel: 86-25-8473-2460  
Fax: 86-25-8473-2470

**China - Qingdao**  
Tel: 86-532-8502-7355  
Fax: 86-532-8502-7205

**China - Shanghai**  
Tel: 86-21-5407-5533  
Fax: 86-21-5407-5066

**China - Shenyang**  
Tel: 86-24-2334-2829  
Fax: 86-24-2334-2393

**China - Shenzhen**  
Tel: 86-755-8864-2200  
Fax: 86-755-8203-1760

**China - Wuhan**  
Tel: 86-27-5980-5300  
Fax: 86-27-5980-5118

**China - Xian**  
Tel: 86-29-8833-7252  
Fax: 86-29-8833-7256

**China - Xiamen**  
Tel: 86-592-2388138  
Fax: 86-592-2388130

**China - Zhuhai**  
Tel: 86-756-3210040  
Fax: 86-756-3210049

### ASIA/PACIFIC

**India - Bangalore**  
Tel: 91-80-3090-4444  
Fax: 91-80-3090-4123

**India - New Delhi**  
Tel: 91-11-4160-8631  
Fax: 91-11-4160-8632

**India - Pune**  
Tel: 91-20-3019-1500

**Japan - Osaka**  
Tel: 81-6-6152-7160  
Fax: 81-6-6152-9310

**Japan - Tokyo**  
Tel: 81-3-6880-3770  
Fax: 81-3-6880-3771

**Korea - Daegu**  
Tel: 82-53-744-4301  
Fax: 82-53-744-4302

**Korea - Seoul**  
Tel: 82-2-554-7200  
Fax: 82-2-558-5932 or  
82-2-558-5934

**Malaysia - Kuala Lumpur**  
Tel: 60-3-6201-9857  
Fax: 60-3-6201-9859

**Malaysia - Penang**  
Tel: 60-4-227-8870  
Fax: 60-4-227-4068

**Philippines - Manila**  
Tel: 63-2-634-9065  
Fax: 63-2-634-9069

**Singapore**  
Tel: 65-6334-8870  
Fax: 65-6334-8850

**Taiwan - Hsin Chu**  
Tel: 886-3-5778-366  
Fax: 886-3-5770-955

**Taiwan - Kaohsiung**  
Tel: 886-7-213-7830

**Taiwan - Taipei**  
Tel: 886-2-2508-8600  
Fax: 886-2-2508-0102

**Thailand - Bangkok**  
Tel: 66-2-694-1351  
Fax: 66-2-694-1350

### EUROPE

**Austria - Wels**  
Tel: 43-7242-2244-39  
Fax: 43-7242-2244-393

**Denmark - Copenhagen**  
Tel: 45-4450-2828  
Fax: 45-4485-2829

**France - Paris**  
Tel: 33-1-69-53-63-20  
Fax: 33-1-69-30-90-79

**Germany - Dusseldorf**  
Tel: 49-2129-3766400

**Germany - Munich**  
Tel: 49-89-627-144-0  
Fax: 49-89-627-144-44

**Germany - Pforzheim**  
Tel: 49-7231-424750

**Italy - Milan**  
Tel: 39-0331-742611  
Fax: 39-0331-466781

**Italy - Venice**  
Tel: 39-049-7625286

**Netherlands - Drunen**  
Tel: 31-416-690399  
Fax: 31-416-690340

**Poland - Warsaw**  
Tel: 48-22-3325737

**Spain - Madrid**  
Tel: 34-91-708-08-90  
Fax: 34-91-708-08-91

**Sweden - Stockholm**  
Tel: 46-8-5090-4654

**UK - Wokingham**  
Tel: 44-118-921-5800  
Fax: 44-118-921-5820